

IXG System

IP network-compatible intercom

IXG Support Tool Setting Manual: Property Manager Mode

Software version: 5.0.0.0 or later

Important

- Before configuring and using the system, read Setting Manual (this document) and Operation Manual carefully.
- For the installation and connection of each device, refer to "Installation Manual."
- Begin installation after reading and understanding the procedures for system configuration.
- The setting file is required for post-installation maintenance and service. Write the setting file to a CD-R or other media and be sure to give it to the customer.
- The illustrations and images in this manual may vary from the actual ones.
- Configure each function according to regulations, laws, and policies related to personal information in the applicable country and municipality.
- Some functions may not be available depending on the version of the station or application being used.

Table of contents

Introduction

1. Notational symbols in this manual	6
2. Device type	7
3. Product manuals	8
4. Station description	9
4.1 Tenant Station (IXG-2C7(-*))	9
4.2 Master Station (IX-MV7-*)	10
4.3 Guard Station (IXG-MK)	12
4.4 Handset Sub Station (IX-RS-*)	14
4.5 Entrance Station (IXG-DM7(-*))	16
4.6 Video Door Station (IX-EA, IX-EAU)/Door Station (IX-FA)	17
4.7 Video Door Station (IX-DVM)	19
4.8 Video Door Station (IX-DA, IX-DB)/Door Stations (IX-BA, IX-BB)	21
4.9 Video Door Station (IX-DV, IX-DVF(-*)) /Door Stations (IX-SSA(-*))	23
4.10 Door Stations (IX-SS-2G)	28
4.11 Lift Control Adaptor (IXGW-LC)	29
4.12 Gateway Adaptor (IXGW-GW, IXGW-TGW(.En))	30
4.13 I/O Adaptor (IXW-MA)	32
4.14 Audio Sub Station (IX-SPMIC) (*Japan only)	33
5. Configuring the system	34
6. Flowcharts for configuring the system	36
7. Flowcharts for Mobile App Integration	37
7.1 Registering the First Intercom App in Each Unit	37
7.2 Adding an Intercom App to Each Unit	39
7.3 When the Type of Mobile Device Using an Intercom App Already Registered to a Residence Was Changed	40
7.4 When the Type of Mobile Device Using an Intercom App Already Registered to a Guard Office or Tenant Was Changed	42

Startup and Configuration

1. System requirements	44
2. Installing IXG Support Tool	45
3. Login and registration of the station	46
4. How to Configure	47
4.1 Settings window	47
4.2 How to Configure	48
5. System settings list	50

Menu bar

1. File	62
1.1 Select Existing System	62
1.2 Delete Existing System	62
1.3 Export System Configuration	63

1.4	Export to IXG Supervision Tool	64
1.5	IXG Support Tool Settings	65
1.6	Exit	67
2.	Connection	68
2.1	Station Search	68
2.2	Download Settings	69
2.3	Upload Settings	71
2.4	Download Log File	74
2.5	Download Access Control Logs File	75
3.	App Integration	76
3.1	Upload Settings to IXG Cloud Server	76
3.2	Upload QR Code to the station for App Registration	79
3.3	Export QR Code for App Registration	80
3.4	Site List	81
3.5	Property manager Account Settings	82
3.6	Manual IXG Cloud Server and Gateway Sync	85
4.	Tools	86
4.1	Message Management	86
5.	View	90
6.	Language	91
7.	Help	92
7.1	About	92
7.2	Download IXG Support Tool Log File	93

System Settings

1.	Site Settings (Move-in Settings)	95
1.1	Building Information	95
1.2	Units / Stations	96
2.	Station Information (Move-in Settings)	98
2.1	Identification	98
2.2	ID / Password	100
2.3	Time	101
3.	System Information (Move-in Settings)	104
3.1	Station List	104
3.2	Mobile App and Phone List	107
3.3	Network Camera List	109
3.4	Group	114
3.5	Custom Sound Registry	117
4.	Call Settings (Move-in Settings)	120
4.1	Called Stations (Door/Sub Stations)	120
4.2	Call Origination	123
4.3	Incoming Call	132
4.4	Guard Button	137
5.	Move-out Settings (Move-out Settings)	138
5.1	Move-out	138
5.2	Delete Unit Information	140
6.	Gateway Settings (Advanced Settings)	141

6.1 Gateway SIM Settings	141
6.2 Telephone Entry Settings	143
7. Paging Settings (Advanced Settings)	146
7.1 Paging Origination	146
7.2 All Page	148
7.3 Building Page	151
7.4 Option Input Page	154
8. Entrance Station Settings (Advanced Settings)	157
8.1 Display	157
8.2 Welcome Screen	161
8.3 Thumbnail Image	163
8.4 Direct Call List	165
8.5 Call Directory	167
8.6 Call Limitation Schedule	169
8.7 Access Card Registration	172
8.8 Access Card Schedule	176
8.9 Access Code	179
9. Function Settings (Advanced Settings)	182
9.1 Door Release QR Code Settings	182
9.2 Paging	183
9.3 Email	184
9.4 Recording	195
9.5 Communication Audio Messages	203
9.6 Chime	205
9.7 Display Mode	209
10. Transfer Settings (Advanced Settings)	221
10.1 Absent Transfer	221
10.2 Delay Transfer	223
10.3 Schedule Transfer	225
10.4 Lock Transfer	231
10.5 Reception Call Settings	232
10.6 Reception Button Settings	234
11. Station Settings (Advanced Settings)	235
11.1 Speed Dials	235
11.2 Privacy	246
11.3 Volume / Tone	247
11.4 Communication	257
11.5 Monitoring	259
11.6 Master Station Display	262
11.7 Camera	264
11.8 Line Supervision	268
11.9 Mobile App and Phone Usage	270
12. Maintenance (Advanced Settings)	271
12.1 Firmware Update	271

Additional Settings

1. Confirming Station Information	274
1.1 Confirming Station Information on the Entrance Station	274





Introduction

This manual describes IXG Support Tool in detail.

The IXG System offers a separate manual for Installation, Settings, and Operations. Refer to the relevant manual.

1. Notational symbols in this manual

The following symbols identify important information concerning operational procedures.

	Indicates that users may require caution (including warning / caution).
	Alerts users to prohibited actions.
	Restricts user actions / provides instructions.
	Tips and additional information for operation.

- Terms displayed on master station and PC screens are indicated as **[XXXX]**.
- Page reference are shown as "[Title \(→ page XX\)](#)," [\(→ page XX\)](#), or [page XX](#).

About Network Security

This system is used while connected to a network, and so may be exposed to the following risks:

- Data breach or leakage via the system
- Illicit operation, impairment, or stoppage of the system by a malicious third party
To prevent these security risks, you must implement, at your own responsibility, network security measures, such as the following:
- The system should be used on a network secured by a firewall or the like.
- When using the unit on a system along with computers and similar devices, make sure that these are protected against computer viruses, illicit programs, and the like.
- To prevent network breaches of video or audio data, authentication data (users names and passwords), notification email data, and the like, implement measures such as restricting access by means of user authentication.
- Store authentication data (user names and passwords) carefully and out of sight from third parties.
- Do not install the system or cables in such a way that they can be easily removed or destroyed.

2. Device type

The stations are shown as below.

	Device Type	Example Model Name
Tenant Stations	IXG-2C7(-*)	IXG-2C7, IXG-2C7-L
Master Stations	IX-MV7-*	IX-MV7-HW, IX-MV7-HW-JP, IX-MV7-W, IX-MV7-HB, IX-MV7-B
Guard Stations	IXG-MK	IXG-MK
Handset Sub Station	IX-RS-*	IX-RS-W, IX-RS-B
PC Master Station	IX-SOFT	IX-SOFT
Video Entrance Stations	IXG-DM7(-*)	IXG-DM7, IXG-DM7-HID, IXG-DM7-HIDA, IXG-DM7-10K
Video Stations	IX-DV, IX-DVF(-*)	IX-DV, IX-DVF, IX-DVF-P, IX-DVF-L, IX-DVF-2RA, IX-DVF-RA
	IX-DA, IX-DB	IX-DA, IX-DB
	IX-EA, IX-EAU	IX-EA, IX-EAU※1
	IX-DVM	IX-DVM
Audio Stations	IX-SSA(-*)	IX-SSA, IX-SSA-2RA, IX-SSA-RA
	IX-SS-2G	IX-SS-2G
	IX-BA, IX-BB	IX-BA, IX-BB
	IX-FA	IX-FA※1
Lift Control Adaptor	IXGW-LC	IXGW-LC
Gateway Adaptor	IXGW-(T)GW	IXGW-GW, IXGW-TGW(.En)
I/O Adaptor	IXW-MA	IXW-MA
Audio Sub Station	IX-SPMIC	IX-SPMIC※1
Intercom Application (AIPHONE IXG)	Intercom App	ASP-IXGI, ASP-IXGA
VoIP Phone	VoIP Phone	VoIP Phone

※1 Japan only

3. Product manuals

Read the "Installation Manual," "Setting Manual," and "Operation Manual" as needed. Have the person who installs or configures the product refer to the relevant manuals.

<div style="border: 1px solid black; padding: 5px; width: fit-content; margin: auto;">Installation Manual</div>	<p>Installation Manual (comes with each station.) Refer to when installing and connecting each station. (For installers)</p>
<div style="border: 1px solid black; padding: 5px; width: fit-content; margin: auto;">Quick Start Programming Guide</div>	<p>Quick Start Programming Guide (comes with IXGW-(T)GW(.En).) This shortened manual describes the most common programming procedures for the IXG Support Tool. (For system administrator)</p>
<p>The manuals listed to the right can be found on our website at "https://www.aiphone.net/support/software-documents/" for download and reference. Download these manuals from our website and refer to them as necessary.</p>	<p>IXG Support Tool Setting Manual (electronic manual.) This document describes how to configure and maintain the system using the IXG Support Tool. (For system administrator)</p>
	<p>Quick Start Programming Guide (Electronic format.) This shortened manual describes the most common programming procedures for the IXG Support Tool. (For system administrator)</p>
	<p>Monitoring Software (IXG Supervision Tool) Operation Manual (electronic manual.) This document describes how to use IXG Supervision Tool. (For system administrator)</p>
	<p>Operation Manual (electronic manual.) This document describes how to use each station. (For user)</p>
	<p>Installation Manual (Electronic format.) Describes how to install each station. (For installers)</p>

4. Station description

For "PC Master Station," refer to the PC Master Station Operation Manual.

4.1 Tenant Station (IXG-2C7(-*))

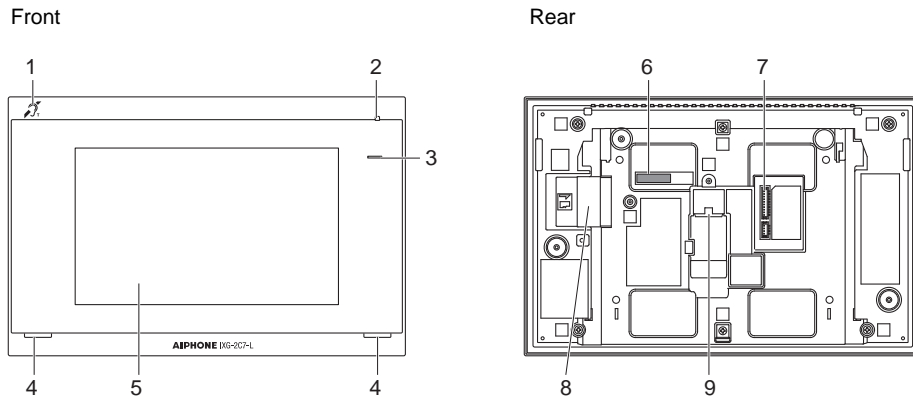

■ Part names



1	Hearing aid T-mode compatibility symbol (IXG-2C7-L only)	6	MAC address
2	Microphone	7	Option connector terminal
3	Status indicator (Blue)	8	microSD card slot
4	Speaker	9	LAN (PoE) port
5	Touchscreen LCD		

■ Indicators

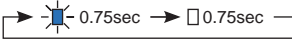
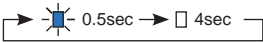
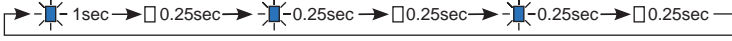
☑: ON, ☐: OFF

Name	Status (pattern)	Description
Status indicator	Blue flashing 	Booting
		Communication failure
		Firmware version updating
	Blue light 	Standby

💡 Note

- For a status other than those noted here, refer to "Operation Manual."
- The display language is English by default.

4.2 Master Station (IX-MV7-*)

■ Part names

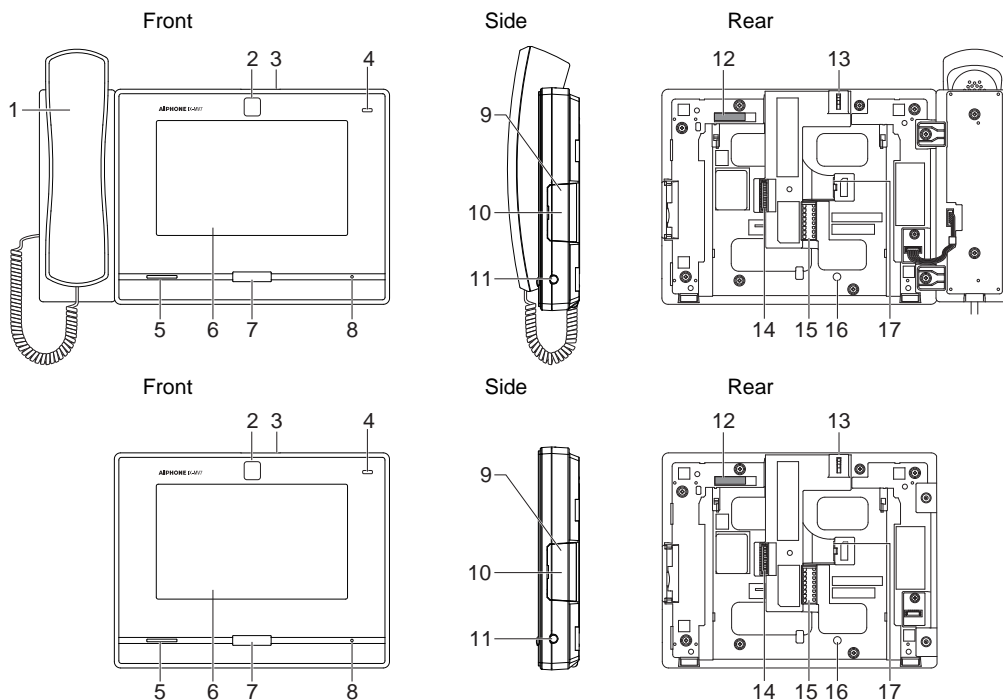





1	Handset	10	microSD card slot*1
2	Camera	11	3.5 mm 4-pole mini jack(CTIA standard)
3	Camera privacy cover lever (on top)	12	MAC address
4	Status indicator (Orange/Blue)	13	Camera angle adjustment lever
5	Speaker	14	Option connector terminal
6	Touchscreen LCD	15	Low-voltage connection terminal
7	Home button	16	Desktop-stand fastening screw hole
8	Microphone	17	LAN (PoE) port
9	Reset button*1*2		

*1 Found by opening cover.

*2 Press and hold the reset button for at least 1 second (less than 5 seconds), then release to restart (reset).

■ Indicators

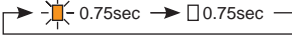
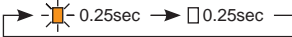
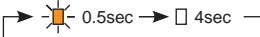
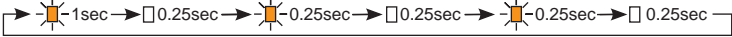
: ON,  : OFF

Name	Status (pattern)	Description
Status indicator		Booting
		Device error, Startup error
		Communication failure Line supervision and device check error
		Firmware version updating
		Initializing
Blue light		Standby(Depends on setting)



Note

- For a status other than those noted here, refer to "Operation Manual."
- The display language is English by default.

4.3 Guard Station (IXG-MK)

■ Part names

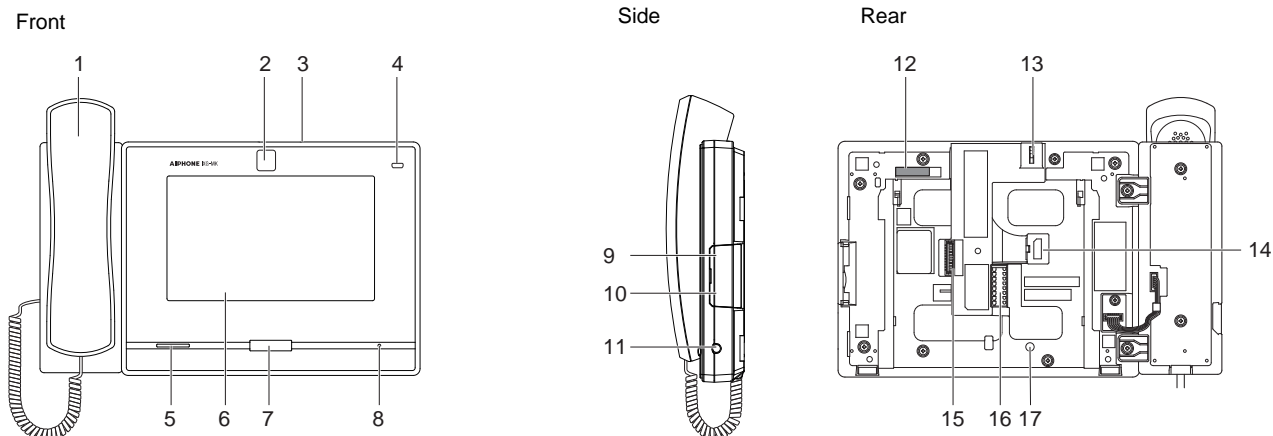



















1	Handset	10	microSD card slot*1
2	Camera	11	3.5 mm 4-pole mini jack(CTIA standard)
3	Camera privacy cover lever (on top)	12	MAC address
4	Status indicator (Orange/Blue)	13	Camera angle adjustment lever
5	Speaker	14	LAN (PoE) port
6	Touchscreen LCD	15	Option connector terminal
7	Home button	16	Low-voltage connection terminal
8	Microphone	17	Desktop-stand fastening screw hole
9	Reset button*1*2		

*1 Found by opening cover.

*2 Press and hold the reset button for 1 - 4 seconds, then release to restart station.

■ Indicators

: ON, : OFF

Name	Status (pattern)	Description
Status indicator	 0.75sec →  0.75sec	Booting
	 0.25sec →  0.25sec	Device error, Startup error
	 0.5sec →  4sec	Communication failure
	 1sec →  0.25sec →  0.25sec →  0.25sec →  0.25sec →  0.25sec	Firmware version updating
	 1sec →  0.25sec →  0.25sec →  0.25sec	Initializing
Blue light		Operating normally (may not light up when in standby depending on setting)



Note

- For a status other than those noted here, refer to "Operation Manual."
- The display language is English by default.

4.4 Handset Sub Station (IX-RS-*)

■ Part names

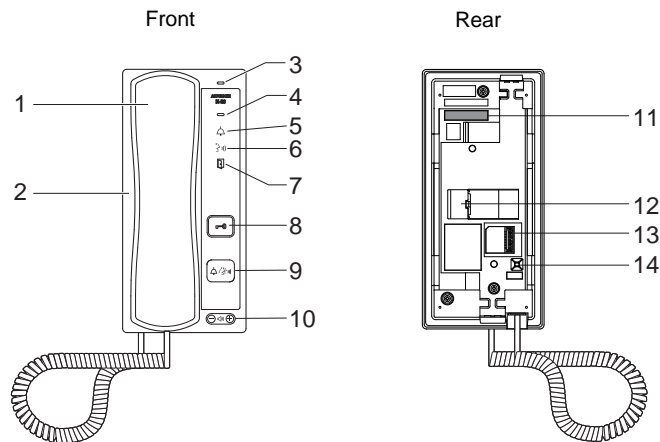

1	Handset	8	Door release button (Green) Only displayed when configured.
2	Speaker	9	Call/Talk button Can be used to call or answer depending on configuration.
3	Microphone	10	Call tone/Incoming voice volume* ¹
4	Status indicator (Orange/Blue)	11	MAC address
5	Call indicator (Green) LED lit during operation.	12	LAN (PoE) port
6	Communication indicator (Orange) LED lit during operation.	13	Connectors
7	Door release indicator (Green) LED lit during operation.	14	Reset button* ²

*¹ The volume can be adjusted for each of the following.

– Volume can be changed during an incoming call or in standby:

Ringtone... 0 (Off), 1 (Low) - 10 (High) (a tone is played each time it is adjusted)



– Volume can be changed during calls:

















Handset Receive... 1 (Low) - 10 (High)

Hands-free Receive (also changes the paging reception and ringback tone volume)... Volume (1) to Volume (10)

*² Press and hold the reset button for 1 - 4 seconds, then release to restart station.

■ Indicators

: ON, : OFF

Name	Status (pattern)	Description
Status indicator	 0.75sec →  0.75sec	Booting
	 0.25sec →  0.25sec	Device error, Startup error
	 0.5sec →  4sec	Communication failure
	 1sec →  0.25sec →  0.25sec →  0.25sec →  0.25sec →  0.25sec	Firmware version updating
	 1sec →  0.25sec →  0.25sec →  0.25sec	Initializing
Blue light		Standby



Note

- For a status other than those noted here, refer to "Operation Manual."

4.5 Entrance Station (IXG-DM7(-*))

Part names

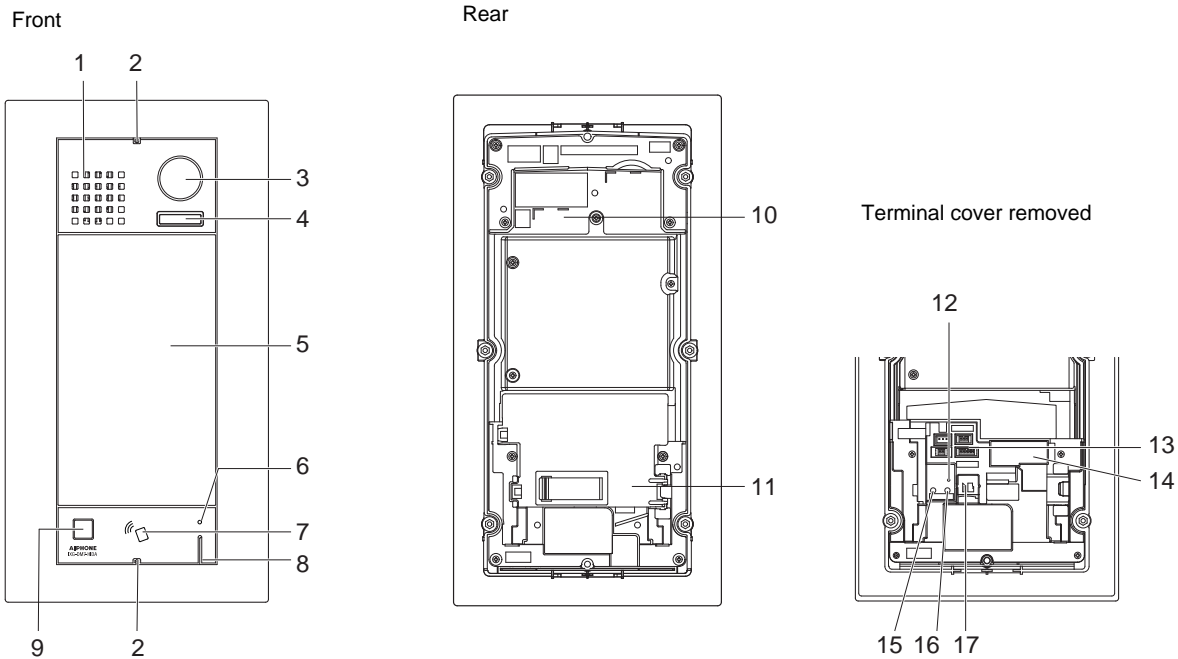

1	Speaker	10	MAC address
2	Special screw	11	Terminal cover
3	Camera	12	microSD card indicator (Red)* ³
4	LED for night illumination* ¹	13	Connectors* ³
5	Touchscreen LCD	14	LAN (PoE) port* ³
6	Card reader status indicator (Red/Green)* ² (IXG-DM7-HID(A) only)	15	Reset button* ³ * ⁴
7	Card reader (IXG-DM7-HID(A) only)	16	microSD card release button* ³
8	Microphone	17	microSD card slot* ³
9	Sensor		

*1 Lights ON when beginning to restart.
Flashes when booting or during ID/password initialization.

*2 Lights ON (red) during normal operation. If the proximity key is authenticated, lights ON (green) for approximately 3 seconds.

*3 Found by opening terminal cover.

*4 Press and hold the reset button for 1 - 4 seconds, then release to restart station.

Note

- The display language is English by default.

4.6 Video Door Station (IX-EA, IX-EAU)/Door Station (IX-FA)

Part names

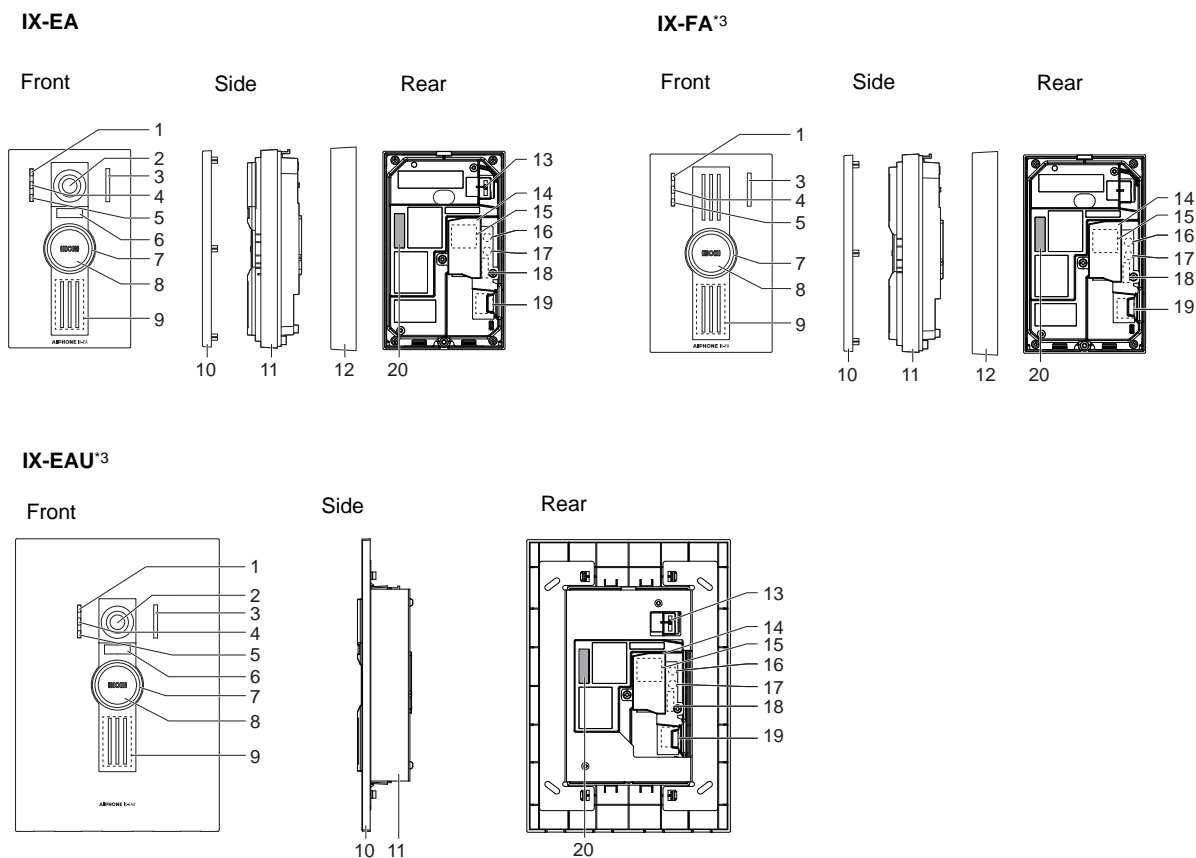



1	Call indicator (Green)	11	Main unit
2	Camera	12	Mounting frame
3	Microphone	13	Camera angle adjustment lever
4	Communication indicator (Orange)	14	Terminal cover
5	Door release indicator (Green)	15	LAN (PoE) port* ¹
6	LED for night illumination	16	Reset button* ¹ * ²
7	Status indicator (Orange/Blue) The ring around the button will illuminate.	17	microSD card release button* ¹
8	Call Button	18	Option connector terminal* ¹
9	Speaker	19	microSD card slot* ¹
10	Panel	20	MAC address





















*1 Accessible when terminal cover is opened.

*2 Press and hold the reset button for 1 - 4 seconds, then release to restart station.

*3 Japan only

■ Indicators

: ON,  : OFF

Name	Status (pattern)	Description
Status indicator	 0.75sec →  0.75sec	Booting
	 0.25sec →  0.25sec	Device error, Startup error
	 0.5sec →  4sec	Communication failure
	 1sec →  0.25sec →  0.25sec →  0.25sec →  0.25sec →  0.25sec	Firmware version updating
	 2sec →  0.25sec →  0.25sec →  0.25sec	Mounting/unmounting microSD card
	 1sec →  0.25sec →  0.25sec →  0.25sec	Initializing
Blue light		Standby



Note

- For a status other than those noted here, refer to "Operation Manual."

4.7 Video Door Station (IX-DVM)

■ Part names

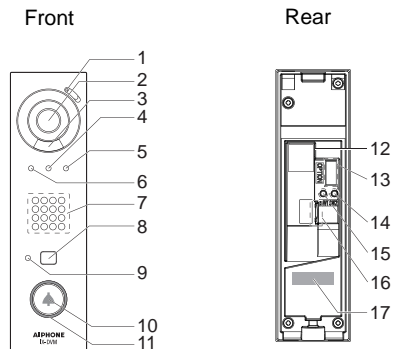





1	Microphone	10	Call Button
2	Camera	11	Status indicator (Orange/Blue) The ring around the button lights up.
3	LED for night illumination	12	LAN (PoE) port
4	Communication indicator (Orange)	13	Option connector terminal
5	Door release indicator (Green)	14	microSD card release button
6	Call indicator (Green)	15	Reset button ^{*1}
7	Speaker	16	microSD card slot
8	Contactless call sensor	17	MAC address
9	Sensor OFF indicator (red)		

*1 Press and hold the reset button for at least 1 second (but less than 5 seconds), then release to restart (reset) the station.

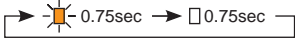
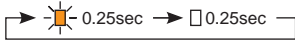
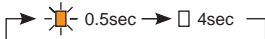
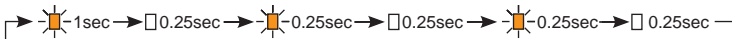
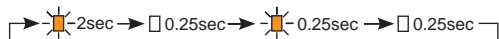
■ Indicators

☀: ON, □: OFF

Name	Status (pattern)	Description
Status indicator	Orange flashing 	Booting
		Device error, Startup error
		Communication failure
		Firmware version updating
		Mounting/unmounting microSD card
		Initializing
	Blue light 	Standby
Sensor OFF indicator	Red light 	Contactless call sensor not available*1

*1 The contactless call sensor cannot be used when "Contactless Call" is disabled in Administrator mode or when the sensor is malfunctioning.

Note

- For a status other than those noted here, refer to "Operation Manual."

4.8 Video Door Station (IX-DA, IX-DB)/Door Stations (IX-BA, IX-BB)

Part names

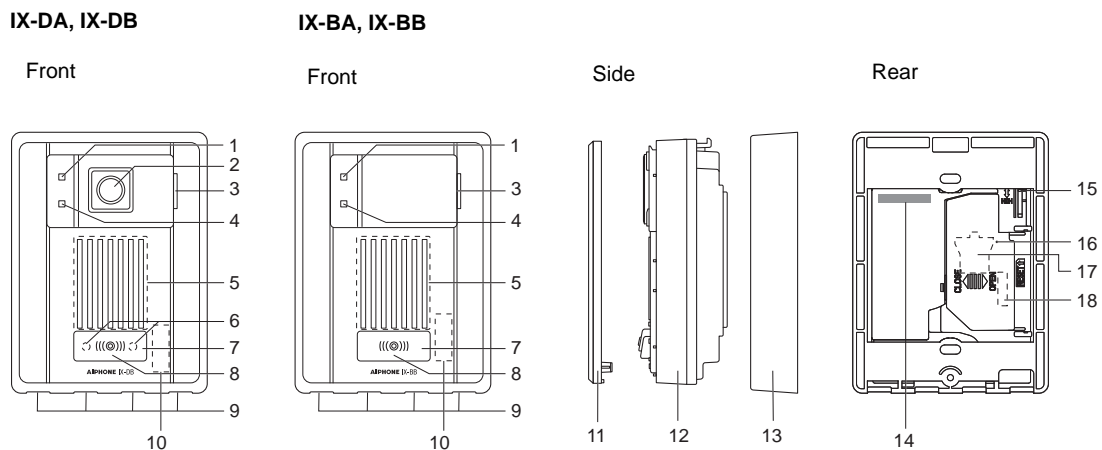

1	Call indicator (Orange)	10	MAC address (beneath the panel)
2	Camera	11	Panel
3	Microphone	12	Main unit
4	Communication indicator (Green)	13	Mounting frame
5	Speaker	14	MAC address
6	LED for night illumination	15	Camera angle adjustment lever (IX-DA, IX-DB only)
7	Call Button	16	Reset button ^{*1*2}
8	Status indicator (Red)	17	LAN (PoE) port ^{*1}
9	Drain holes (4)	18	Connectors ^{*1}

*1 Found by opening terminal cover.

*2 Press and hold the reset button for 1 - 4 seconds, then release to restart station.

■ Indicators

☀: ON, □ : OFF

Name	Status (pattern)	Description
Status indicator	Red flashing ☀ 0.75sec → □ 0.75sec	Booting
	☀ 0.25sec → □ 0.25sec	Device error
	☀ 0.5sec → □ 4sec	Communication failure
	☀ 1sec → □ 0.25sec → ☀ 0.25sec → □ 0.25sec → ☀ 0.25sec → □ 0.25sec	Firmware version updating
	☀ 1sec → □ 0.25sec → ☀ 0.25sec → □ 0.25sec	Initializing
	Red light ☀	Standby



Note

- For a status other than those noted here, refer to "Operation Manual."

4.9 Video Door Station (IX-DV, IX-DVF(-*)) /Door Stations (IX-SSA(-*))

■ Part names

IX-DV

Front

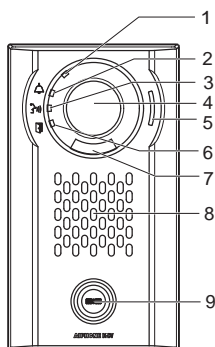

Rear

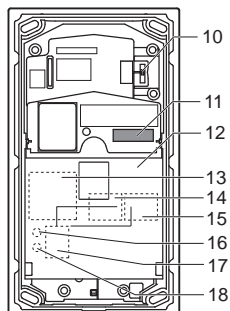

IX-DVF

Front

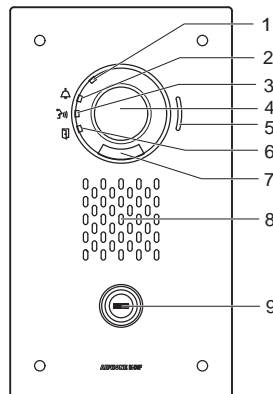

Rear

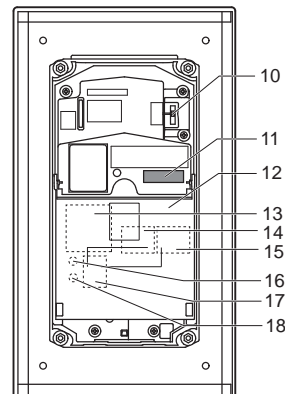

1	Status indicator (Orange/Blue)	10	Camera angle adjustment lever
2	Call indicator (Green)	11	MAC address
3	Communication indicator (Orange)	12	Terminal cover
4	Camera	13	Option connector terminal*1
5	Microphone	14	LAN2 terminal (PoE/PSE)*1
6	Door release indicator (Green)	15	LAN1 terminal (PoE/PD)*1
7	LED for night illumination	16	Reset button*1*2
8	Speaker	17	microSD card slot*1
9	Call Button The ring around the button will illuminate (blue).	18	microSD card release button*1

*1 Found by opening the terminal cover.

*2 Press and hold the reset button for 1 - 4 seconds, then release to restart station.

IX-DVF-2RA

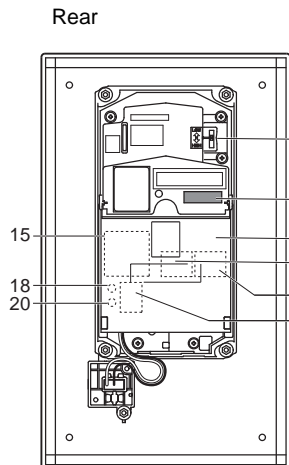
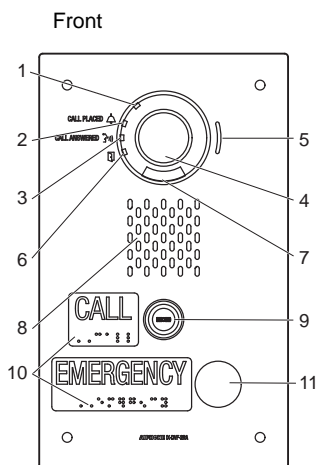

IX-DVF-RA

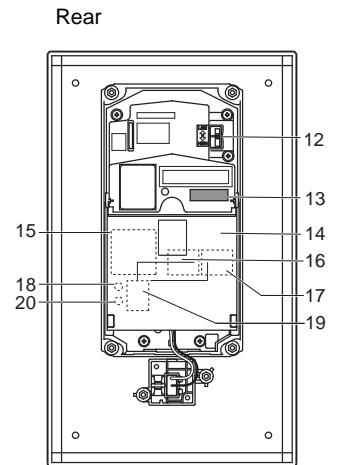
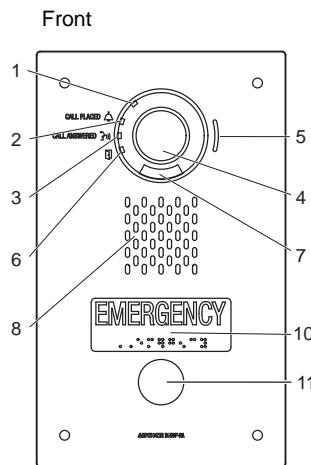

1	Status indicator (Orange/Blue)	11	Urgent call button
2	Call indicator (Green)	12	Camera angle adjustment lever
3	Communication indicator (Orange)	13	MAC address
4	Camera	14	Terminal cover
5	Microphone	15	Option connector terminal*1
6	Door release indicator (Green)	16	LAN2 terminal (PoE/PSE)*1
7	LED for night illumination	17	LAN1 terminal (PoE/PD)*1
8	Speaker	18	Reset button*1*2
9	Call Button The ring around the button will illuminate (blue).	19	microSD card slot*1
10	Braille	20	microSD card release button*1

*1 Found by opening terminal cover.

*2 Press and hold the reset button for 1 - 4 seconds, then release to restart station.

IX-DVF-P

Front

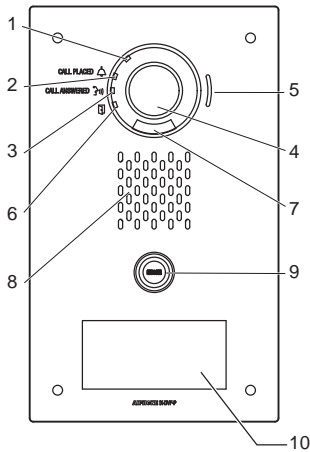

Rear

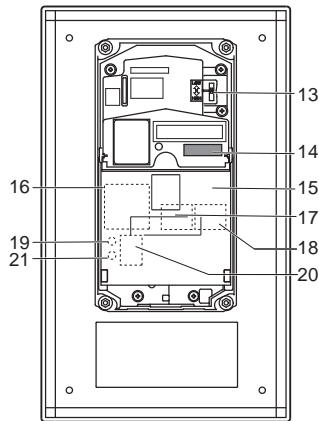

IX-DVF-L

Front

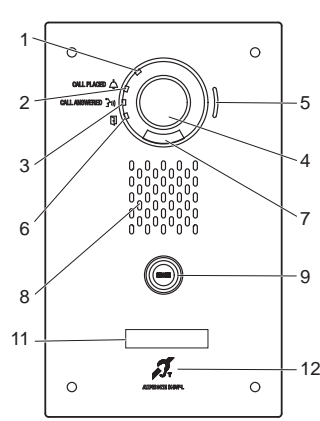

Rear

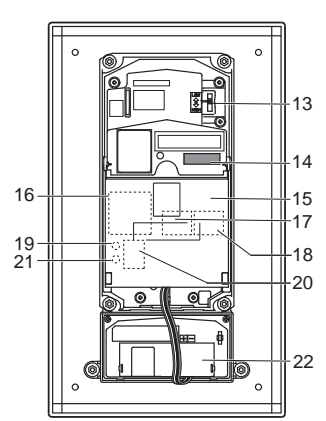

1	Status indicator (Orange/Blue)	12	Hearing aid (T mode) compatible symbol
2	Call indicator (Green)	13	Camera angle adjustment lever
3	Communication indicator (Orange)	14	MAC address
4	Camera	15	Terminal cover
5	Microphone	16	Option connector terminal*1
6	Door release indicator (Green)	17	LAN2 terminal (PoE/PSE)*1
7	LED for night illumination	18	LAN1 terminal (PoE/PD)*1
8	Speaker	19	Reset button*1*2
9	Call Button The ring around the button will illuminate (blue).	20	microSD card slot*1
10	HID reader	21	microSD card release button*1
11	Nameplate (with backlight)	22	Hearing aid unit

*1 Found by opening terminal cover.

*2 Press and hold the reset button for 1 - 4 seconds, then release to restart station.

IX-SSA

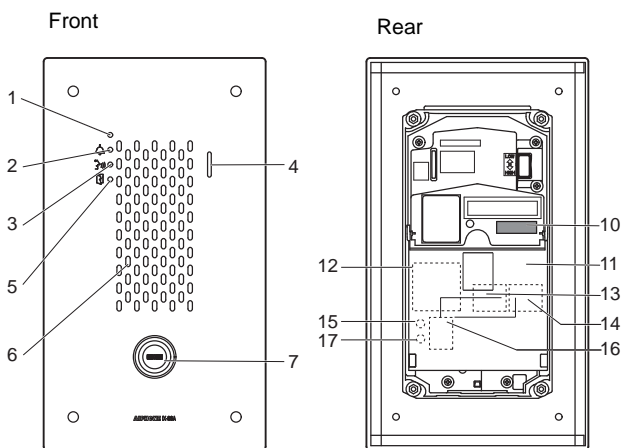

IX-SSA-2RA

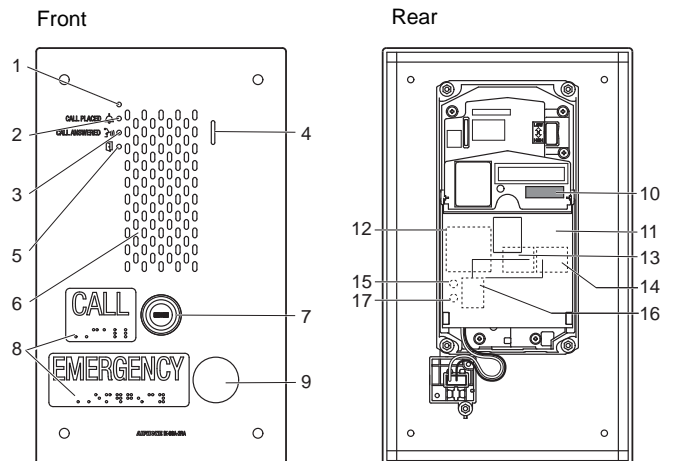

IX-SSA-RA

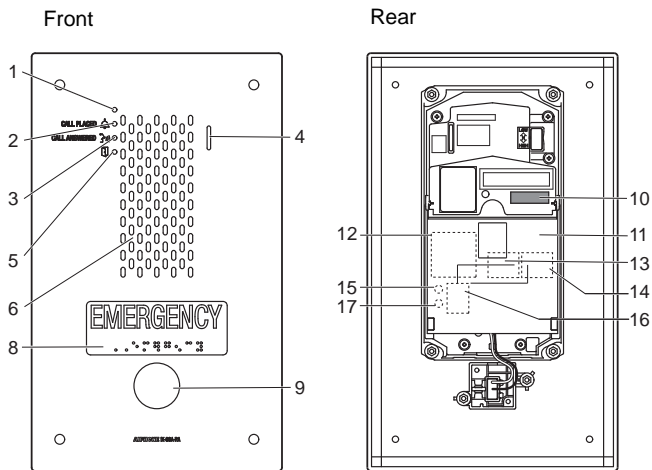







1	Status indicator (Orange/Blue)	10	MAC address
2	Call indicator (Green)	11	Terminal cover
3	Communication indicator (Orange)	12	Option connector terminal*1
4	Microphone	13	LAN2 terminal (PoE/PSE)*1
5	Door release indicator (Green)	14	LAN1 terminal (PoE/PD)*1
6	Speaker	15	Reset button*1*2
7	Call Button The ring around the button will illuminate (blue).	16	microSD card slot*1
8	Braille	17	microSD card release button*1
9	Urgent call button		

*1 Found by opening terminal cover.

*2 Press and hold the reset button for 1 - 4 seconds, then release to restart station.

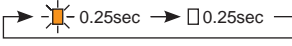
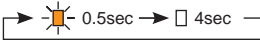
■ Indicators

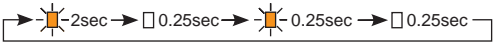
: ON, : OFF

Name	Status (pattern)	Description
Status indicator		Booting
		Device error, Startup error
		Communication failure
		Firmware version updating
		Mounting/unmounting microSD card
		Initializing
Blue light		Standby



Note

- For a status other than those noted here, refer to "Operation Manual."

4.10 Door Stations (IX-SS-2G)

Part names

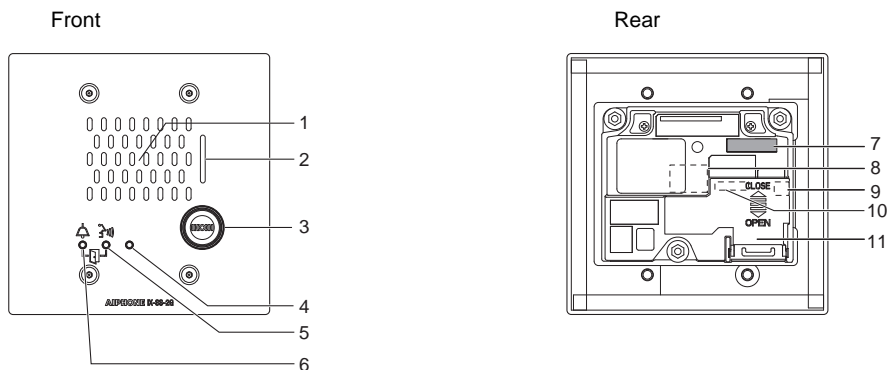

1	Speaker	7	MAC address
2	Microphone	8	LAN (PoE) port ^{*1}
3	Call Button	9	Reset button ^{*1*2}
4	Status indicator (Orange/Blue)	10	Low-voltage connection terminal ^{*1}
5	Communication indicator (Orange)	11	Terminal cover
6	Call indicator (Green)		

*1 Found by opening terminal cover.

*2 Press and hold the reset button for 1 - 4 seconds, then release to restart station.

Indicators

☀: ON, □: OFF

Name	Status (pattern)	Description
Status indicator	Orange flashing ☀ 0.75sec → □ 0.75sec	Booting
	☀ 0.25sec → □ 0.25sec	Device error, Startup error
	☀ 0.5sec → □ 4sec	Communication failure
	☀ 1sec → □ 0.25sec → ☀ 0.25sec → □ 0.25sec → ☀ 0.25sec → □ 0.25sec	Firmware version updating
	☀ 1sec → □ 0.25sec → ☀ 0.25sec → □ 0.25sec	Initializing
Blue light	☀	Standby

Note

- For a status other than those noted here, refer to "Operation Manual."

4.11 Lift Control Adaptor (IXGW-LC)

Part names

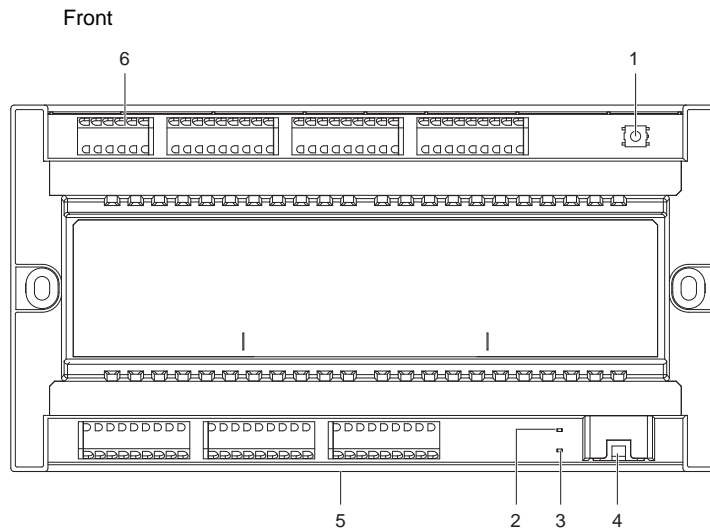



1	Reset button*1	4	LAN (PoE) port
2	Status indicator (Orange)	5	Lock release lever (Back)
3	Status indicator (Green)	6	Low-voltage connection terminal

*1 Press and hold the reset button for 1 - 4 seconds, then release to restart station.

*2 The MAC address is found on the rear on the device.

Indicators

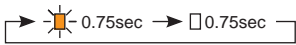
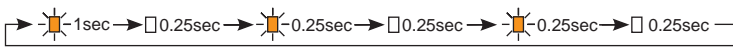
☀: ON, □: OFF

Name	Status (pattern)	Description
Status indicator	Orange flashing 	Booting
		Firmware version updating
		Initializing
Green light		Standby

4.12 Gateway Adaptor (IXGW-GW, IXGW-TGW(.En))

■ Part names

IXGW-GW

Front

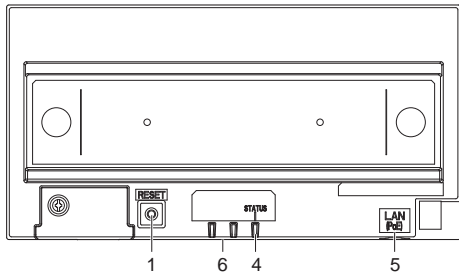

IXGW-TGW(.En)

Front

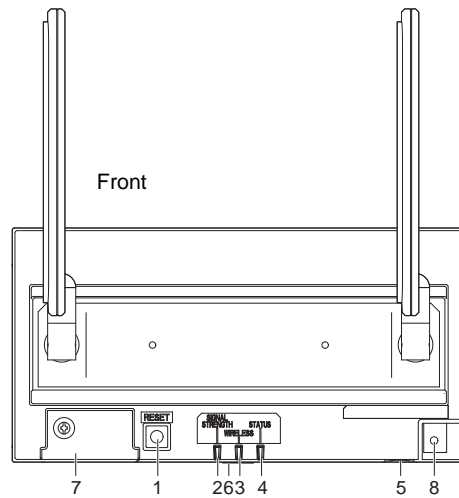

1	Reset button	5	LAN (PoE) port
2	Signal strength indicator (green)	6	Lock release lever (Back)
3	Wireless status indicator (green)	7	nanoSIM card slot* ² If using a SIM card, configure “Gateway SIM Settings (→page 141)” .
4	Status indicator (Orange/Green)	8	Wireless OFF button

*1 Press and hold the reset button for 1 - 4 seconds, then release to restart station.

*2 Found by opening cover.







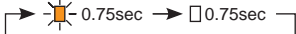
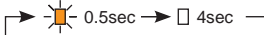
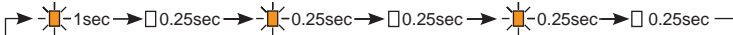
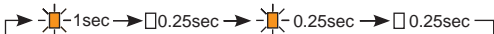

*3 The MAC address is found on the rear on the device.

! Important

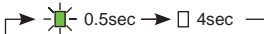
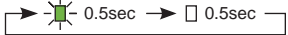
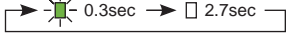
- Due to the features and services provided by the Gateway Adaptor and the AIPHONE IXG app, future required changes to device functionality, network communication, security, etc. may require firmware updates unavailable to the Gateway Adaptor. In this situation, the Gateway Adaptor would need to be replaced at the cost of the responsible party.
- To remove the SIM card, first ensure that the power is turned OFF.
- To turn the power OFF, press the wireless OFF button for at least 1 second, and then remove the LAN cable. Doing otherwise could cause the device to malfunction.

■ Indicators

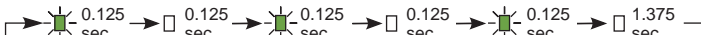
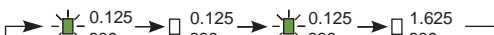
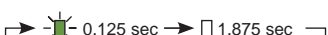
☀: ON, □: OFF

Name	Status (pattern)	Description	
Status indicator	Orange light 	IXG Cloud Server authentication error	
	Orange flashing		Booting
			Communication failure
			Firmware version updating
			Initializing
	Green light 	Standby	
	Green flashing (IXGW-TGW.En only) 	Wired or wireless connection error with IXG Cloud Server	
	Wireless status indicator	Green flashing	
			Connected with base station
Green light 		Communication module shutting down	
Signal strength indicator	Green light 	SIM PIN locked	
	Green flashing		Signal reception level 5 (strong)
			Signal reception level 4
			Signal reception level 3
			Signal reception level 2
Green OFF 	Signal reception level 1 (no signal)		

4.13 I/O Adaptor (IXW-MA)

Part names

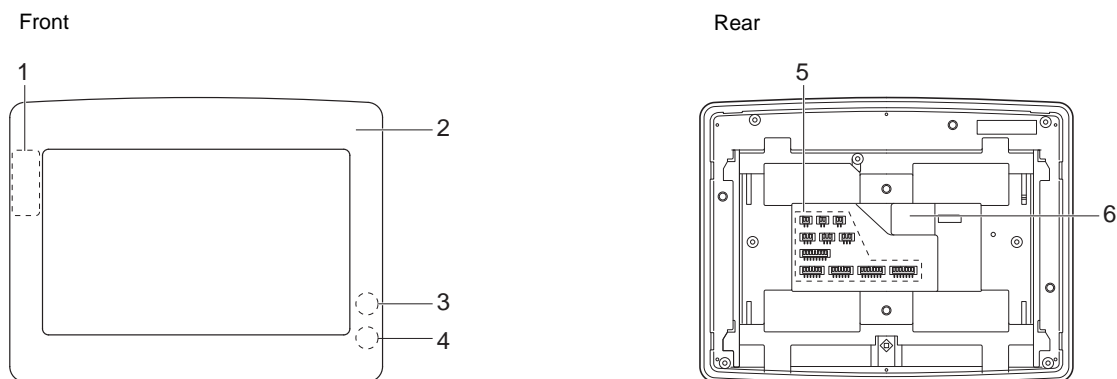

1	MAC address* ¹	4	Status indicator (Orange/Blue)* ¹
2	Panel	5	Option connector terminal
3	Reset button* ^{1,2}	6	LAN (PoE) port

*1 The panel must be removed to access it.

*2 Press and hold the reset button for at least 1 second (but less than 5 seconds), then release to restart (reset) the station.

Indicators

☀: ON, □: OFF

Name	Status (pattern)	Description
Status indicator	Orange flashing ☀ 0.75sec → □ 0.75sec	Booting
	Orange flashing ☀ 0.25sec → □ 0.25sec	Device error, Startup error
	Orange flashing ☀ 0.5sec → □ 4sec	Communication failure
	Orange flashing ☀ 1sec → □ 0.25sec → ☀ 0.25sec → □ 0.25sec → ☀ 0.25sec → □ 0.25sec	Firmware version updating
	Orange flashing ☀ 1sec → □ 0.25sec → ☀ 0.25sec → □ 0.25sec	Initializing
Blue light	☀	Standby

4.14 Audio Sub Station (IX-SPMIC) (*Japan only)

Part names

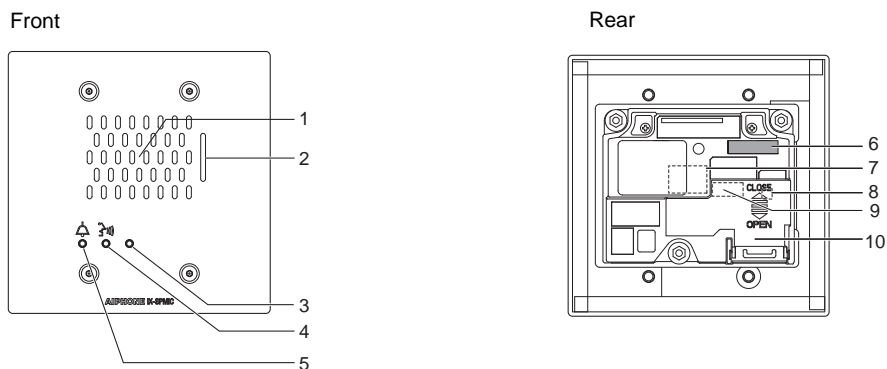

1	Speaker	6	MAC address
2	Microphone	7	LAN (PoE) port ^{*1}
3	Status indicator (Orange/Blue)	8	Reset button ^{*1*2}
4	Communication indicator (Orange)	9	Low-voltage connection terminal ^{*1}
5	Call indicator (Green)	10	Terminal cover

*1 Found by opening the terminal cover.

*2 Press and hold the reset button for at least 1 second (but less than 5 seconds), then release to restart (reset) the station.

Indicators

☀: ON, □: OFF

Name	Status (pattern)	Description
Status indicator	Orange flashing ☀ 0.75sec → □ 0.75sec	Booting
	☀ 0.25sec → □ 0.25sec	Device error, Startup error
	☀ 0.5sec → □ 4sec	Communication failure
	☀ 1sec → □ 0.25sec → ☀ 0.25sec → □ 0.25sec → ☀ 0.25sec → □ 0.25sec	Firmware version updating
	☀ 1sec → □ 0.25sec → ☀ 0.25sec → □ 0.25sec	Initializing
Blue light	☀	Standby

Note

- For a status other than those noted here, refer to "Operation Manual."

5. Configuring the system

The IXG System can be configured using the following methods.

- Configure the system using the "IXG Support Tool" application.
 - Install the application on a PC and use to create the configuration for all stations.
 - Search for IXG system stations on the network, assign and upload the setting file for the system.

There are two configuration modes for IXG Support Tool.

- Administrator mode: Configure all settings.
- Property Manager mode: Configure only the following settings.

Move-in Settings

- Site Settings
 - Site Information (read only)
 - Building Information
 - Units / Stations
- Station Information
 - Identification
 - ID / Password
 - Time
- System Information
 - Station List
 - Mobile App and Phone List
 - Network Camera List
 - Group
 - Custom Sound Registry
- Call Settings
 - Called Stations (Door/Sub Stations)
 - Call Origination
 - Incoming Call
 - Guard Button

Move-out Settings

- Move-out Settings
 - Move-out
 - Delete Unit Information

Advanced Settings

- Gateway Settings
 - Gateway SIM Settings
 - Telephone Entry Settings
- Paging Settings
 - Paging Origination
 - All Page
 - Building Page
 - Option Input Page
- Entrance Station Settings
 - Display
 - Welcome Screen
 - Thumbnail Image
 - Direct Call List
 - Call Directory
 - Call Limitation Schedule
 - Access Card Registration
 - Access Card Schedule
 - Access Code
- Function Settings
 - Door Release QR Code Settings

- Paging
- Email
- Recording
- Communication Audio Messages
- Chime
- Display Mode
- Transfer Settings
 - Absent Transfer
 - Delay Transfer
 - Schedule Transfer
 - Lock Transfer
 - Reception Call Settings
 - Reception Button Settings
- Station Settings
 - Speed Dials
 - Privacy
 - Volume / Tone
 - Communication
 - Monitoring
 - Master Station Display
 - Camera
 - Line Supervision
 - Mobile App and Phone Usage
- Maintenance
 - Firmware Update

This document describes how to configure using Property Manager mode. Refer to the separate "IXG Support Tool Setting Manual: Administrator Mode" document for information on the Administrator mode.

 **Important**

- Be sure to store the setting file that was created. If the setting file is lost, you may be charged a separate setting fee during maintenance or post-installation maintenance and service.

6. Flowcharts for configuring the system

Follow the flowchart below when changing the settings using IXG Support Tool.

Save the settings after configuring the system. Otherwise, it may become impossible to restore the settings after maintenance or after-sales servicing.

Flowcharts are for configuration using IXG Support Tool.

Configure the PC Master Station map settings on the respective PC Master Station after configuring IXG Support Tool settings.

1. Set the language.

["Language \(→page 91\)"](#)



2. Download the settings from all the stations.

["Download Settings \(→page 69\)"](#)



3. Perform setup.

Follow the instructions for each setting item and perform setup.

["System Settings \(→page 94\)"](#)

If using App Integration, configure settings following the detailed explanation in "App Integration Flowchart."

["Flowcharts for Mobile App Integration \(→page 37\)"](#)



Has the "Building Information," "Station Number," "Station Name," or "Camera Name" been changed?

YES



NO



4. Upload the setting data to all stations.

["Upload Settings \(→page 71\)"](#)

4. Upload the setting data to the station whose settings were changed.

["Upload Settings \(→page 71\)"](#)



5. Complete

7. Flowcharts for Mobile App Integration

! Important

- Due to the features and services provided by the Gateway Adaptor and the AIPHONE IXG app, future required changes to device functionality, network communication, security, etc. may require firmware updates unavailable to the Gateway Adaptor. In this situation, the Gateway Adaptor would need to be replaced at the cost of the responsible party.
- QR code is a registered trademark of Denso Wave Incorporated.

7.1 Registering the First Intercom App in Each Unit

The flowchart below describes the process of creating a new site using the IXG Support Tool, and then registering an Intercom App with the site.

1. Configure the "Number of available Mobile Apps" in ["Units / Stations \(→page 96\)"](#).



2. Configure the following settings.

- Gateway SIM Settings ["Gateway SIM Settings \(→page 141\)"](#)
- IXG Support Tool Settings ["IXG Support Tool Settings \(→page 65\)"](#)
- Building Name ["Building Information \(→page 95\)"](#)
- Change Password during Initial Login ["Property manager Account Settings \(→page 82\)"](#)
- Unit Name ["Units / Stations \(→page 96\)"](#)
- Station Name ["Identification \(→page 98\)"](#)
- Station List ["Station List \(→page 104\)"](#)
- Mobile App and Phone List ["Mobile App and Phone List \(→page 107\)"](#)

* Configuration not required if already registered.



3. Apply the settings to the existing site in IXG Cloud Server.

["Upload Settings to IXG Cloud Server \(→page 76\)"](#)



4. Generate a PDF of the QR code for app registration.

["Export QR Code for App Registration \(→page 80\)"](#)

* If there is already a Tenant Station in the residence, send the QR code for app registration to the Tenant Station. The QR code can be confirmed on the screen of the registered Intercom App.

["Upload QR Code to the station for App Registration \(→page 79\)"](#)





5. Upload the setting file to the station.

[“Upload Settings \(→page 71\)”](#)



6. Register the Intercom App on the mobile device by scanning the QR code.

7.2 Adding an Intercom App to Each Unit

The following flowchart describes the process for adding additional Intercom Apps in a unit which is already connected to IXG Cloud Server.

Important

- Refer to [“Registering the First Intercom App in Each Unit \(→page 37\)”](#) for information on registering the first Intercom App in each unit.

1. Configure the "Number of available Mobile Apps" in [“Units / Stations \(→page 96\)”](#).



2. Configure the following settings.

- Station Name [“Identification \(→page 98\)”](#)
- Station List [“Station List \(→page 104\)”](#)



3. Apply the settings to the existing site in IXG Cloud Server.

[“Upload Settings to IXG Cloud Server \(→page 76\)”](#)



4. Generate a PDF of the QR Code for Intercom App registration.

[“Export QR Code for App Registration \(→page 80\)”](#)



5. Upload the setting file to the station.

[“Upload Settings \(→page 71\)”](#)



6. Register the Intercom App on the mobile device by scanning the QR code.

* For a residential Intercom App where a Tenant Station is installed in the residence, touch **[Settings]-[Mobile App Configuration]-[Register Apps]** on the Home Screen of the Tenant Station to display the QR code.

7.3 When the Type of Mobile Device Using an Intercom App Already Registered to a Residence Was Changed

The flowchart below describes the process of changing the type of mobile device using an Intercom App already registered, and then using a new mobile device.

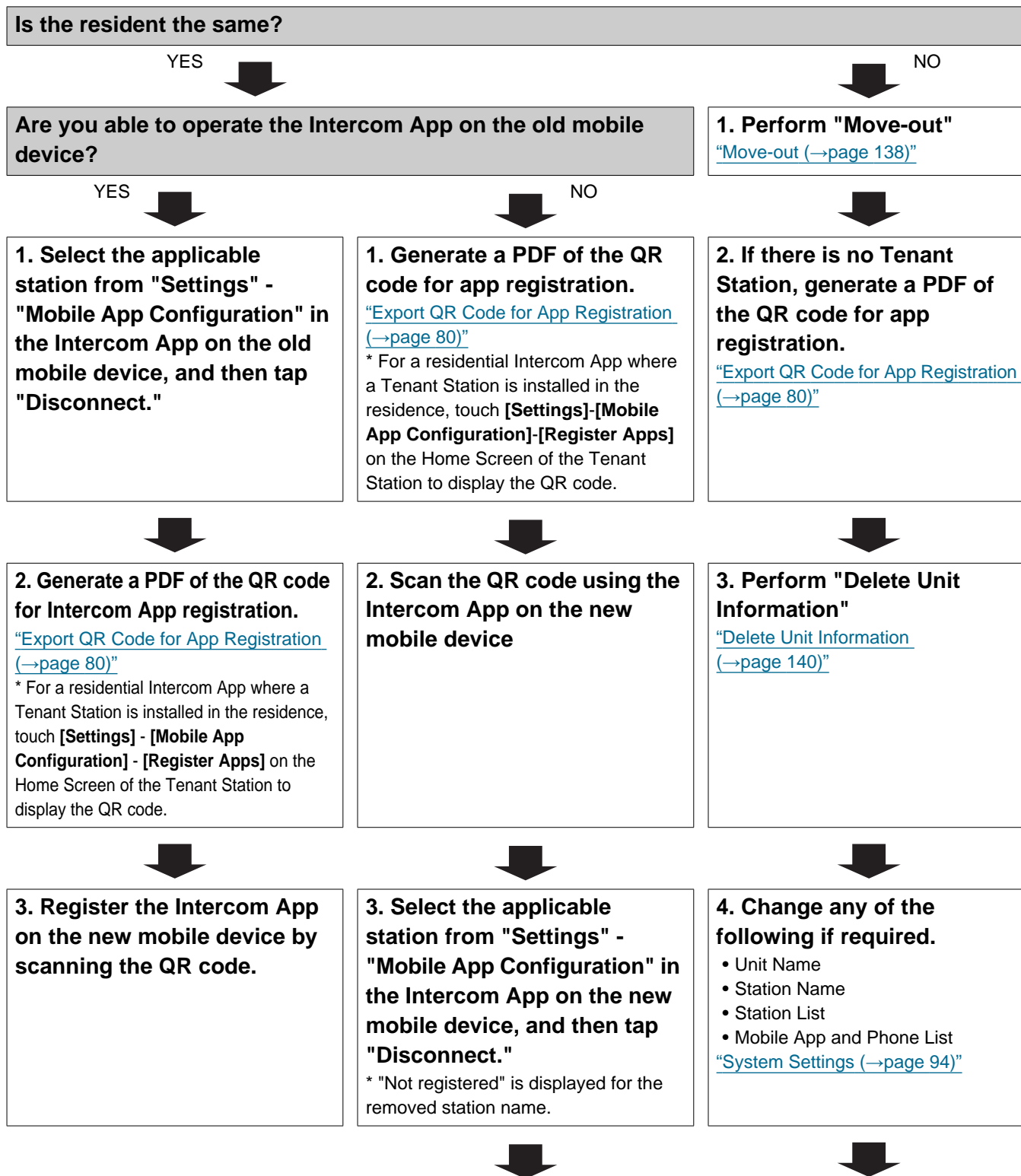



4. Tap the removed station name in "Mobile App Configuration" in the Intercom App on the new mobile device, and then tap [Connect].



5. Upload the settings to the IXG Cloud Server.
["Upload Settings to IXG Cloud Server \(→page 76\)"](#)



6. Upload the setting file to the station.
["Upload Settings \(→page 71\)"](#)



7. Have the new resident scan the QR code using the Intercom App on the mobile device to perform registration

7.4 When the Type of Mobile Device Using an Intercom App Already Registered to a Guard Office or Tenant Was Changed

The flowchart below describes the process of changing the type of mobile device using an Intercom App already registered, and then using a new mobile device.

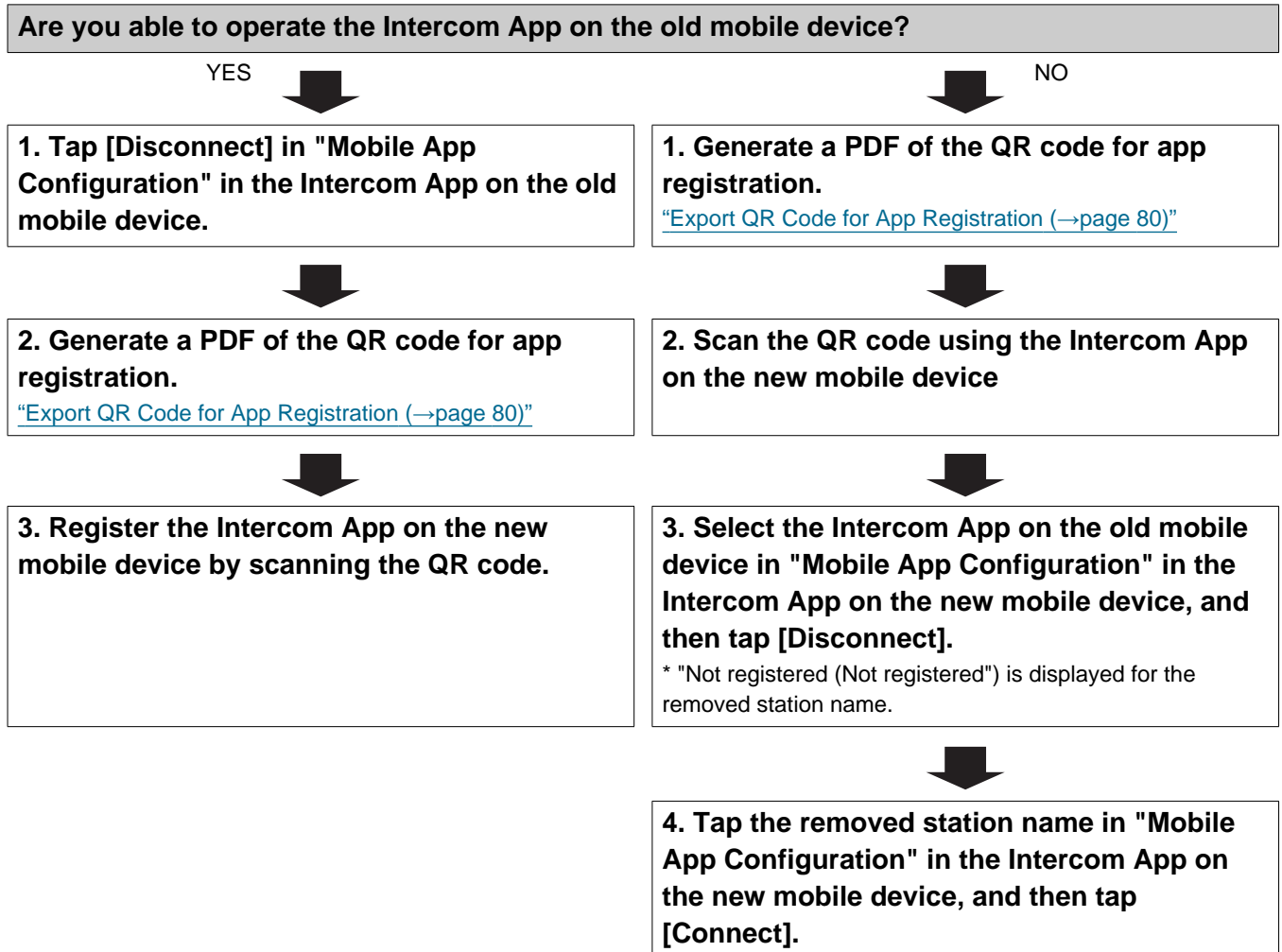

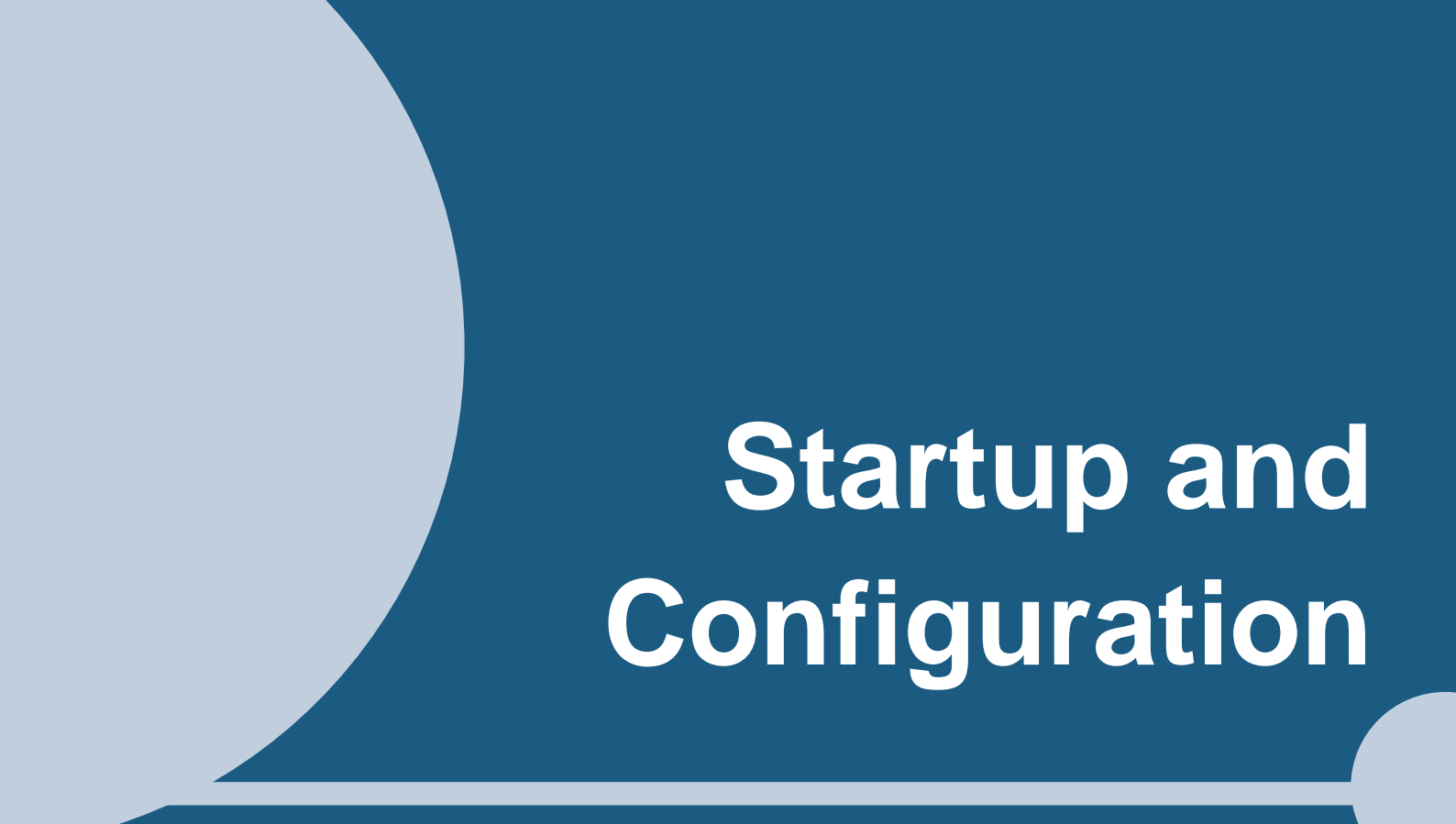

Startup and Configuration

1. System requirements

The PC must meet the following requirements to use the IXG Support Tool.

Operating System	Windows 7 Windows 8 Windows 8.1 Windows 10 Windows 11
CPU	32 bit (x86) processor or 64 bit (x64) processor of 1 GHz or higher
Memory	4 GB RAM or higher
Resolution	1280x768 or greater



Note

- Set the display size setting of your PC to “100%”.
If set to a setting other than “100%”, the screen of the IXG Support Tool may not be displayed correctly.
- Windows is a registered trademark of Microsoft Corporation in the United States and/or other countries.

2. Installing IXG Support Tool

1. Access our website at <https://www.aiphone.net/support/software-documents/> and download the IXG Support Tool to your PC.
2. Double-click the downloaded file ("AIPHONE_IXG_SupportTool_Setup.exe") to install IXG Support Tool.

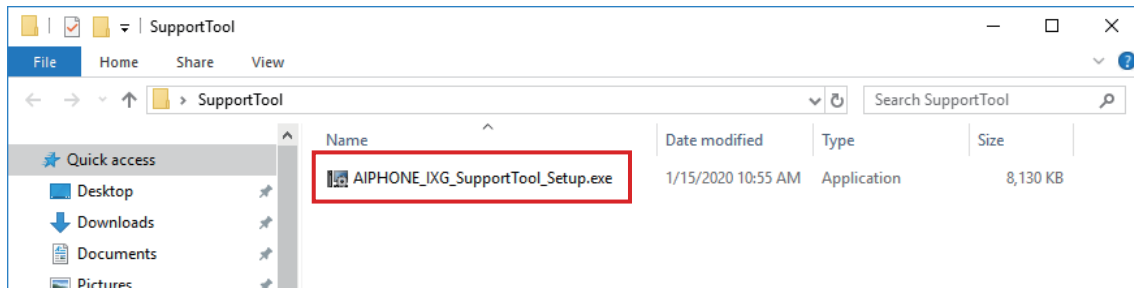

3. Select the components to install the IXG Support Tool, and then click **[Next]**.

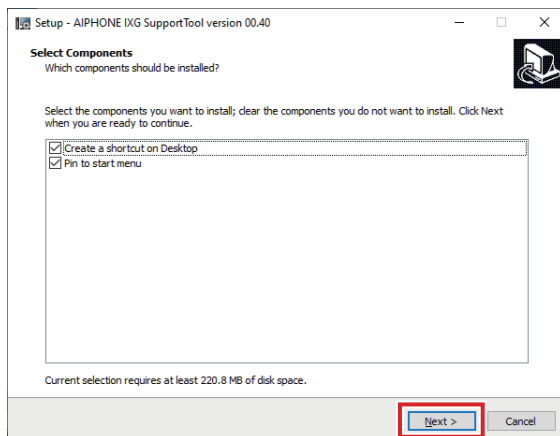

4. Click **[Finish]**.
 - IXG Support Tool is now installed.

4. How to Configure

After logging into IXG Support Tool, the Settings screen is displayed. The Settings screen is used to configure settings.

- Depending on PC and OS being used, the window may be slightly different.
- After configuration, refer to the "Operation Manual" for each station and confirm operation.

4.1 Settings window

Settings screen sample

All stations in the system can be configured using the table.

Update: Click to update the settings.

Menu bar: Can be used to create new setting data. ["Menu bar" \(→page 61\)](#)

Title bar: Displays the site name and title when editing settings.

Information: Click to display notes.

Building Number	Unit Number	Station Name	Station Information	
			ID / Password	
			ID(Administrator)	Password(Administrator)
01	001	Entrance Station1	alphone	*****
01	001	Entrance Station2	alphone	*****
01	0001	Master Station1	alphone	*****
01	0002	Video Door Station1	alphone	*****
01	101	Tenant Station1	alphone	*****
01	101	Video Door Station1	alphone	*****
01	102	Tenant Station1	alphone	*****
01	103	Tenant Station1	alphone	*****
01	104	Tenant Station1	alphone	*****
01	106	Tenant Station1	alphone	*****
01	201	Guard Station1	alphone	*****
01	202	Master Station1	alphone	*****
01	203	Video Door Station1	alphone	*****
01	207	Handset Sub Station1	alphone	*****
01	208	Handset Sub Station1	alphone	*****

Setting menu: Displays a list of titles. Click the title to configure to display the appropriate Settings screen.

Settings screen: The Settings screen for the currently selected title is displayed.



Note

- Settings which cannot be modified will be grayed out.

4.2 How to Configure

1. Click the title to be configured.
 - The Settings window for that particular title will be shown.
2. Enter setting values for each entry.
 - The selected field will turn orange.
 - When changing the settings, the field will turn pink.
 - Some titles allow copy and paste.

Building Number	Unit Number	Station Type	Station Information	
			Identification	
			Station Number	Station Name
01	001	IXG-DM7(-*)	010010	Entrance Station1
01	001	IXG-DM7(-*)	010011	Entrance Station2
01	0001	IX-MV7-*	012030	Master Station1

Required settings.

! Important

- Be sure to input the settings for entries in red. Use the default values, unless a change is necessary.
- Select an entry field and press the F1 key to display an explanation screen.

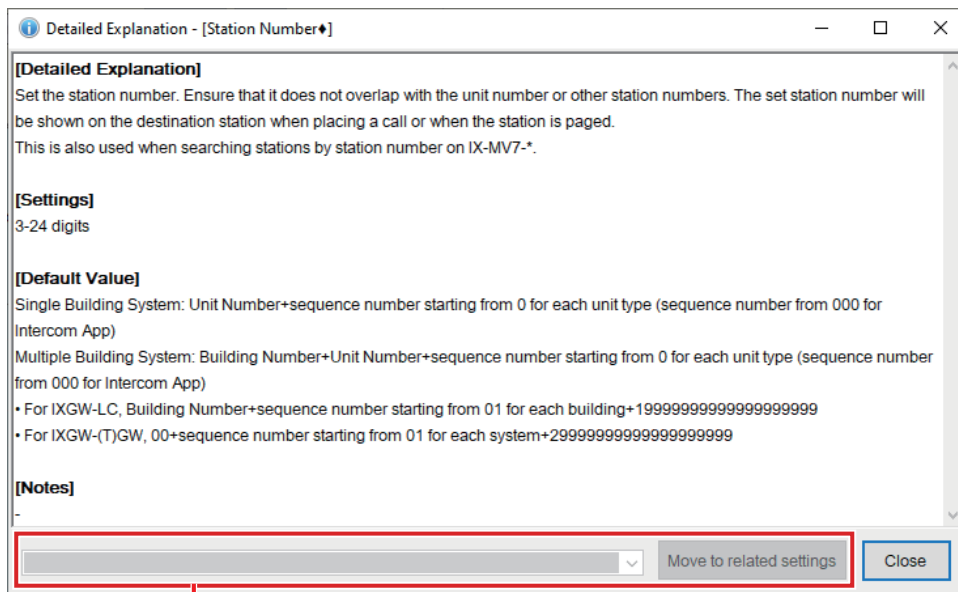

Move to related settings: This allows you to move to the Settings screen for related entries.

- Pressing [Ctrl] + [F] displays the Search window, which allows the search function to be used. Enter the text to search and click **[Find Next]** to move to the applicable cell.
-  is displayed when the cursor is moved over an entry. Clicking this allows you to use the filter function. Select what to display and then click **[Apply]** to display only the applicable information.

Building Number	Unit Number	Station Type	Station Information	
			Station Number	Station Name
01	001			Entrance Station1
01	001			Entrance Station2
01	0001			Master Station1
01	0002			Geo Door Station1
01	101			Plant Station1
01	101			Intercom App1
01	101			Intercom App2

(Select All)
 Intercom App
 IX-DA, IX-DB
 IX-DV, IX-DVF(-*)
 IXG-2C7(-*)
 IXG-DM7(-*)
 IXG-MK
 IXGW-(T)GW

B Text Filter ▾ Apply Clear Cancel

- 3.** When you are done configuring on this screen, click **[Update]** to save the settings.
- To cancel all changes, click another title in the Setting menu. Click **[Cancel]** to return to the previous screen.
 - If there is an error when clicking **[Update]**, the error message will be shown and the settings will not be allowed to be saved.
- The cell will be shown in red if there is an error in the settings.

Building Number	Unit Number	Station Type	Station Information	
			Station Number	Station Name
01	001	IXG-DM7(-*)	010010	Entrance Station1
01	001	IXG-DM7(-*)		Entrance Station2
01	0001	IX-MV7-*	012030	Master Station1

Required

- 4.** Perform Steps 1 - 3 for other titles as well.

5. System settings list

The following items can be configured using IXG Support Tool.

The symbols indicate the following:

- ◆: Requires a setting value. Use the default values, unless a change is necessary.
- The following table provides an overview of IXG Support Tool. The content, how they are displayed, and the order of entries may vary from the actual screens.
- Download and back up the setting data "[Export System Configuration \(→page 63\)](#)" in case post-installation maintenance and service are required, and store it in a safe place where it will not be lost.
If a backup has not been performed, it may not be possible to recover the data during after-sales service.

Setting items				Reference pages		
Site Settings (Move-in Settings)						
Building Information	-	-	Building Name◆	95		
Units / Stations	-	-	-	96		
			Unit Name◆	96		
			First Name	97		
			Last Name	97		
			Phone Registration (Guard, Commercial, Residential only)	97		
			Number of available Mobile Apps (Guard, Commercial, Residential only)	97		
Station Information (Move-in Settings)						
Identification	-	-	-	98		
			Station Number◆	98		
			Station Name◆	99		
ID / Password	-	-	-	100		
			ID(Administrator)◆	100		
			Password(Administrator)◆	100		
Time	-	-	-	101		
			Time Zone	Select time zone	101	
			Daylight Saving Time	Automatic Daylight Saving Time	101	
			Manual Date / Time Setup	-	102	
System Information (Move-in Settings)						
Station List	-	-	-	104		
Mobile App and Phone List	-	-	-	107		
Network Camera List	-	-	-	109		
			Network Camera Registry	-	Camera Name◆	111
					Hostname	111
					IP Address (IPv4)◆	111
			IP Address (IPv6)◆	111		

Setting items				Reference pages
			ID◆	111
			Password◆	111
Group	-	-	-	114
	Configuring a Group	-	-	115
Custom Sound Registry	-	-	-	117
Call Settings (Move-in Settings)				
Called Stations (Door/Sub Stations)	-	-	-	120
Call Origination	Call Origination Advanced Settings	-	Call Method	123
			Ringback Tone	124
			Call Timeout◆	124
			Ringback Tone Count [time(s)]	124
			Call Destination ([contact input 1 - 4] only)	125
			Standard Mode Settings	125
			Destination Dwell 1-8	125
			Destination Dwell Time◆	125
	Weekly Schedule	-	-	126
			Start Time	126
			End Time	126
			Call Destination	127
			Priority	127
	Daily Schedule	-	-	129
			Start Time	129
			End Time	129
			Call Destination	130
			Priority	130
	Tone Settings	-	Busy Tone	130
			Error Tone (Call Failed)	131
Call Restart Function	-	-	Call Restart Function	131
Incoming Call	-	-	-	132
	Call Answer Settings	-	Auto Answer	132
	Ringtone	-	Ringtone	133
			Ringback Tone Count [time(s)]	133
			Call Button	134
			Option Input	135
			Call Button Ringtone Count [time(s)]	135
Option Input Ringtone Count [time(s)]	136			

Setting items				Reference pages
	VoIP Phone	-	VoIP Phone Call Priority	136
Guard Button	-	-	Select Station	137
			Mobile Apps and Phone	137
Move-out Settings (Move-out Settings)				
Move-out	-	-	-	138
Delete Unit Information	-	-	-	140
Gateway Settings (Advanced Settings)				
Gateway SIM Settings	APN Settings	APN	-	141
		User Name	-	141
		Password	-	141
		Authentication Type	-	141
		APN protocol	-	141
		Network Type	-	141
		MCC/MNC	Selection Method	142
		MCC	142	
		MNC	142	
		PIN Code Settings	PIN	-
	Code		-	142
Telephone Entry Settings	-	-	-	143
	How to register phone numbers (if registering using the IXG Support Tool)	-	Registered Phone Number	144
			Relay Output 1	144
			Relay Output 2	144
	How to register phone numbers (if registered by the resident)	-	Relay Output 1	144
Relay Output 2			144	
Paging Settings (Advanced Settings)				
Paging Origination	-	-	Paging Timeout [sec]◆	146
			Paging Wait Timer [sec]◆	146
			Urgent Page Response	147
			Lock Paging	147
All Page	-	-	-	148
Building Page	-	-	-	151
Option Input Page	-	-	-	154
			Destination	154
			Recorded Page	154
			Number	155
			Building Number / Building Name	155

Setting items				Reference pages	
			Priority	155	
			Message File Name	156	
			Ringback Tone Count [time(s)]	156	
Entrance Station Settings (Advanced Settings)					
Display	-	-	Door Release Keypad	157	
			Door Release QR Code	157	
			Call by Unit Number	157	
			Call by List	158	
			Search by Name	158	
			Call Directory	158	
			Display Call by Directory thumbnails	158	
			Default Display Screen	159	
			Building Selection Button	159	
			Hearing aid Icon	159	
			Display Video	159	
			Language Icon	160	
			Available Languages	160	
Welcome Screen	-	-	-	161	
			Welcome Screen Wallpaper	161	
			Image	Display	162
File name	162				
Thumbnail Image	-	-	-	163	
			File name	163	
Direct Call List	-	-	-	165	
			Display Thumbnail Image	165	
			Button Number 1 to 500	165	
Call Directory	-	-	-	167	
Call Limitation Schedule	-	-	-	169	
			Call Limitation	169	
			Display Thumbnail Image	169	
	Schedule Settings	-	-	Call Destination 1 to 6	170
				Start Time	170
				End Time	170
Access Card Registration	-	-	-	172	
			Card Format	172	
			Facility Code	172	
	Access Card Registration	-	-	Unit / User Group Name◆	173
				Access Card Mode	173
				Card Number 1 to 10	173

Setting items				Reference pages
			Relay Output 1	173
			Relay Output 2	174
	Access Card Batch Registration	-	-	174
	Copy Access Card Information to other Station(s)	-	-	175
Access Card Schedule	-	-	-	176
			Schedule Name◆	177
	Weekly Schedule	-	(Day) Operation	177
			Start Time	177
			End Time	177
	Holiday Schedule	-	Operation	178
			Date	178
			Start Time	178
End Time			178	
Access Code	-	-	-	179
	Add Access Code	-	-	180
	Delete Access Code	-	-	181
Function Settings (Advanced Settings)				
Door Release QR Code Settings	-	-	-	182
Paging	-	-	-	183
	Paging pretone setting	-	Paging Pretone	183
Email	-	-	-	184
	Server Settings	-	SMTP Server	184
			SMTP Port◆	185
			SMTP Encryption	185
	Authentication Settings	-	SMTP Authentication	185
			Mode	185
			ID	185
			Password	186
	Email Addresses	-	Destination Address 1 to 10	186
			Source Address	186
	Email Event Trigger	-	Outgoing Normal Call	186
			Incoming Normal Call	187
			Outgoing Priority Call	187
			Incoming Priority Call	187
Outgoing Urgent Call			187	
Incoming Urgent Call			187	
Door Release Activated			188	
Call Failed			188	

Setting items				Reference pages	
			Latch Reset	188	
			Error	188	
			Station Restarted	188	
			SD Card Error	189	
			Recording Memory Full	189	
			Line Supervision (Passed)	189	
			Line Supervision (Failed)	189	
			Device Check (Passed)	190	
			Device Check (Failed)	190	
			Subject	190	
	Periodic Log Transmission	-		Periodic Log Transmission	192
				Periodic Log Transmit Time	192
				Periodic Log Transmit Interval	192
	Send Test Email	-		-	193
Additional Settings	-		Attach Image	194	
			Image Filename	194	
Recording	-	-	-	195	
	Recording Mode	-	-	197	
	Recording Event	-		Incoming Call	197
				Communication (Master)	197
				Monitoring	198
				Call Origination	198
				Communication (Door/Entrance)	198
				When Monitored	198
				Schedule	198
	Recorded Device	-	-	199	
	Overwrite Protection	-	-	199	
	Video Recording File Length	-	-	199	
	Event Recording Timer	-	-	200	
	Manual Recording	-	-	200	
	Audio Recording	-	-	200	
	Weekly Schedule	-		-	201
				Start Time	201
End Time				201	
Communication Audio Messages	-	-	-	203	
	Start Communication	-	Message	203	
	Code Received	-	Code	204	

Setting items				Reference pages	
			Message	204	
Chime	-	-	-	205	
	Weekly Schedule	-	Start Time	205	
			Chime	206	
	Daily Schedule	-	-	207	
			Start Time	207	
			Chime	208	
Display Mode	Master UI Mode	-	-	209	
	Standard Mode	-	Home Screen	210	
			Automatic Entry Button	211	
			Reception Mode Button	211	
	Receptionist Mode	Color Scheme	-	-	212
				Screen Layout	213
		Company Information	-	Name	215
				Text Size◆	215
				Bold	215
				Text Color	215
		Greeting Information	-	Greeting	216
				Text Size◆	216
				Bold	216
				Text Color	216
		Images	-	Company Image	217
				Greeting Image	217
				Receptionist Image	217
		Button Function	-	Button 1	218
				Button 2	218
				Button 3	218
				Button 4	218
				Button Name for Group Call	219
				Button Name for Select by Name	219
				Button Name for Select by List	219
	Button Name for Enter Number			219	
	Group Call Destination	-	219		
	Reject Incoming Call	-	220		
	Transfer Settings (Advanced Settings)				
	Absent Transfer	-	-	-	221
Absent Transfer				221	
Transfer Destination List				224	
Re-Transfer Destination				222	
Delay Transfer	-	-	-	223	

Setting items				Reference pages	
			Delay Transfer	223	
			Delay Time [sec]◆	223	
			Transfer Destination List	224	
			Re-Transfer Destination	224	
Schedule Transfer	-	-	-	225	
			Schedule Transfer	225	
	Weekly Schedule	-	-	-	226
				Transfer Destination List	226
				Re-Transfer Destination	226
				Start Time	227
				End Time	227
	Daily Schedule	-	-	-	228
				Transfer Destination List	229
				Re-Transfer Destination	229
Start Time				230	
End Time				230	
Lock Transfer	-	-	-	231	
Reception Call Settings	-	-	-	232	
	Reception Call Settings	-	-	232	
Reception Button Settings	-	-	-	234	
Station Settings (Advanced Settings)					
Speed Dials	-	-	-	235	
	Advanced Speed Dial Button Settings	Speed Dial Button Name	-	235	
		Function	-	236	
		How to configure Individual Call	Station Number	236	
			Priority	237	
		How to configure Group Call	Number	237	
			Priority	237	
		How to configure Group Page	Number	237	
			Priority	238	
		How to configure all page	Priority	238	
			Recorded Page	238	
		How to configure Group Message Page	Number	238	
			Message File Name	239	
			Priority	239	
			Ringback Tone Count [time(s)]	239	

Setting items			Reference pages		
		How to configure All Message Page	Message File Name	240	
			Priority	240	
			Ringback Tone Count [time(s)]	240	
			How to configure Monitoring	Station Number	241
				Network Camera	241
			How to configure option relays	Total	241
				Output Time Range	242
				Output Time ♦	242
				TLS	242
			How to configure building page	Option Relay Control Key	243
				Building Number / Building Name	243
				Priority	243
			How to configure Building Message Page	Recorded Page	243
				Building Number / Building Name	244
				Message File Name	244
			How to configure Unit Call	Priority	244
				Ringback Tone Count [time(s)]	245
				Select Unit	245
			Lock	Priority	245
				-	245
Privacy	-	-	-	246	
			Privacy	246	
Volume / Tone	Volume	-	-	247	
			Handset Transmit	247	
			Handset Receive	247	
			Hands-free Transmit	248	
			Hands-free Receive	248	
			Headset Jack Transmit	248	
			Headset Jack Receive	248	
			External Input	248	
			External Output	249	
			VoIP Phone Volume Adjustment	249	
			Ringtone	249	
			Paging	249	
			Button Feedback	249	

Setting items				Reference pages	
	Tone	-	Communication Timeout Notification	250	
			Communication End Pretone	251	
			Call Queue Notification	251	
			Paging Pretone	252	
			Auto Answer Tone	253	
			On Hold	254	
			Key Received	254	
			Error	255	
	Mic Select	-	-	255	
	Headset Specification	-	-	255	
Audio Output	-	-	256		
Audio Output (for Door)	-	-	256		
Communication	-	-	-	257	
			Talk Timeout [sec]◆	257	
			Communication Start Tone	258	
			Force Touch-to-Talk	258	
Monitoring	-	-	-	259	
			Monitor Timeout [sec]◆	259	
	Scan Monitoring	-	-	Type	260
				Station Number	260
				Camera Settings	260
				Dwell Time	260
	Prevent Being Monitored	-	-	261	
	Monitoring Notification Tone	-	-	261	
Monitored LED Notification	-	-	261		
Master Station Display	-	-	-	262	
			Brightness	262	
			Primary Video Source	262	
			Aspect Ratio	262	
			Standby LED State	263	
			Keypad	263	
Camera	-	-	-	264	
			Adjustment	-	Backlight Compensation
	Color Settings	-	-	Low Light Correction	264
				Brightness◆	265
				Contrast◆	265
	Night Illumination LED	-	-	Color◆	265
				Call / Communication	266
				When Monitored	266

Setting items				Reference pages
	PTZ Preset Position	-	-	266
	Zoom / Wide Preset	-	-	267
	Refresh Rate	-	-	267
Line Supervision	-	-	-	268
	Line Supervision Interval	-	Test Interval	268
			Weekly	268
			Line Supervision Schedule	269
	Device Check Interval	-	Test Interval	269
			Weekly	269
Device Check Schedule			269	
Mobile App and Phone Usage	-	-	Mobile App and Phone Usage Notification	270
Maintenance (Advanced Settings)				
Firmware Update	-	-	-	271

Menu bar

Important

- The symbols indicate the following:
 - ◆: Be sure to enter a setting value. Use the default values, unless a change is necessary.

1. File

1.1 Select Existing System

Edit a setting file that already exists. This allows you to load a setting file that was saved. Select "File" - "Select Existing System." The "System Selection" screen will be displayed.

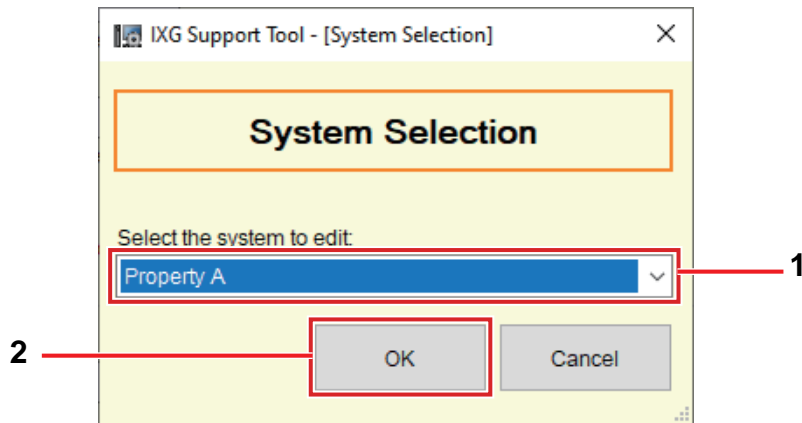

1. Select the system (site name) for the setting file to edit.
2. Click **[OK]**.
 - In the Setting window, the selected setting data will be shown.
 - Click **[Cancel]** to quit without selecting a system.

1.2 Delete Existing System

Delete created setting data. Setting data cannot be deleted while it is being edited. Select "File" - "Delete Existing System." The "Delete System" screen is displayed.

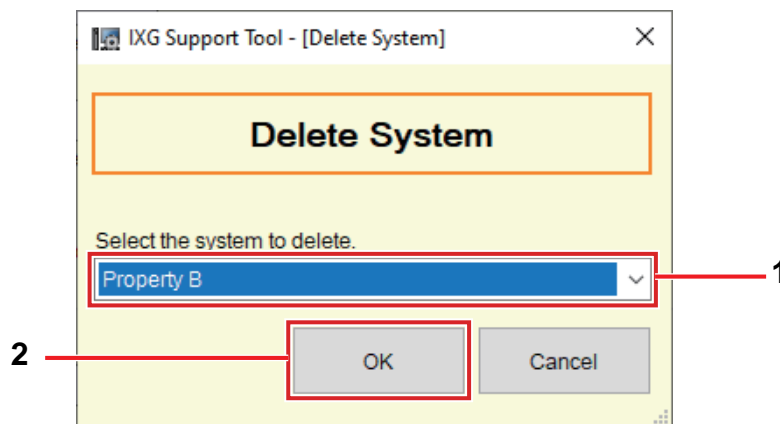

1. Select the system (site name) for the setting file to delete.
2. Click **[OK]**.
 - Delete the selected setting data.
 - Click **[Cancel]** to quit without deleting a system.
3. Click **[OK]**.
 - Click **[Cancel]** to return to the "Delete System" screen.

1.3 Export System Configuration

Backup setting files created in IXG Support Tool.

If the settings are lost, it may be impossible to restore them after maintenance or after-sales servicing.

Select "File" - "Export System Configuration." The "Export Settings" screen is displayed.

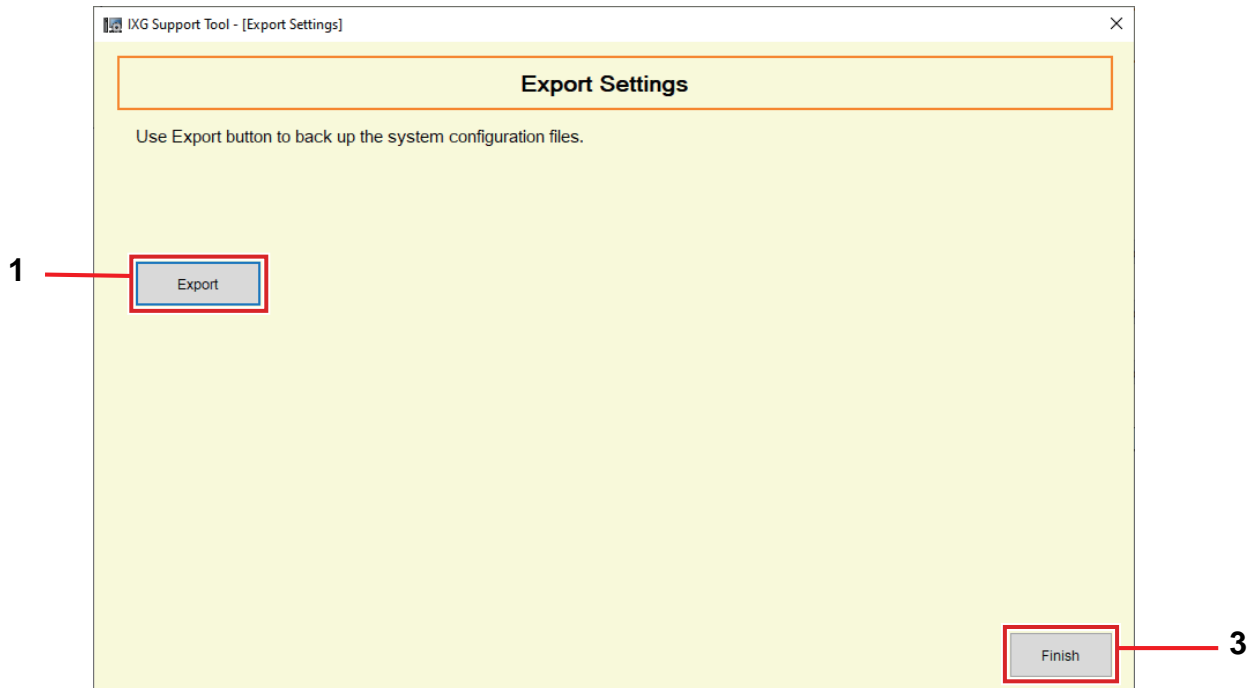

1. Click **[Export]**.
2. Select the folder where the setting file is saved and click **[OK]**.
 - A folder with the name specified in "Site Name" will be created in the specified directory, and the system configuration file will be saved inside as a hidden file.
Copy the entire "Site Name" folder to store the setting file.
 - Click **[Cancel]** to return to the "Export Settings" screen without saving the setting file.
3. Click **[Finish]**.

1.4 Export to IXG Supervision Tool

To use registered station information with the IXG Supervision Tool, output the file in Address Book format. Select "File" - "Export to IXG Supervision Tool" to display the following screen.



1. Click **[Browse]** and select the folder where the setting file will be saved.
2. Click **[Export]**.
 - Files cannot be output from stations in which "IP Address" has not been configured in Administrator mode.
3. Click **[OK]**.
 - The setting file will be saved as "IXGSettingAddressList.txt."

1.5 IXG Support Tool Settings

Select "File" - "IXG Support Tool Settings." The "IXG Support Tool Settings" screen will be displayed.

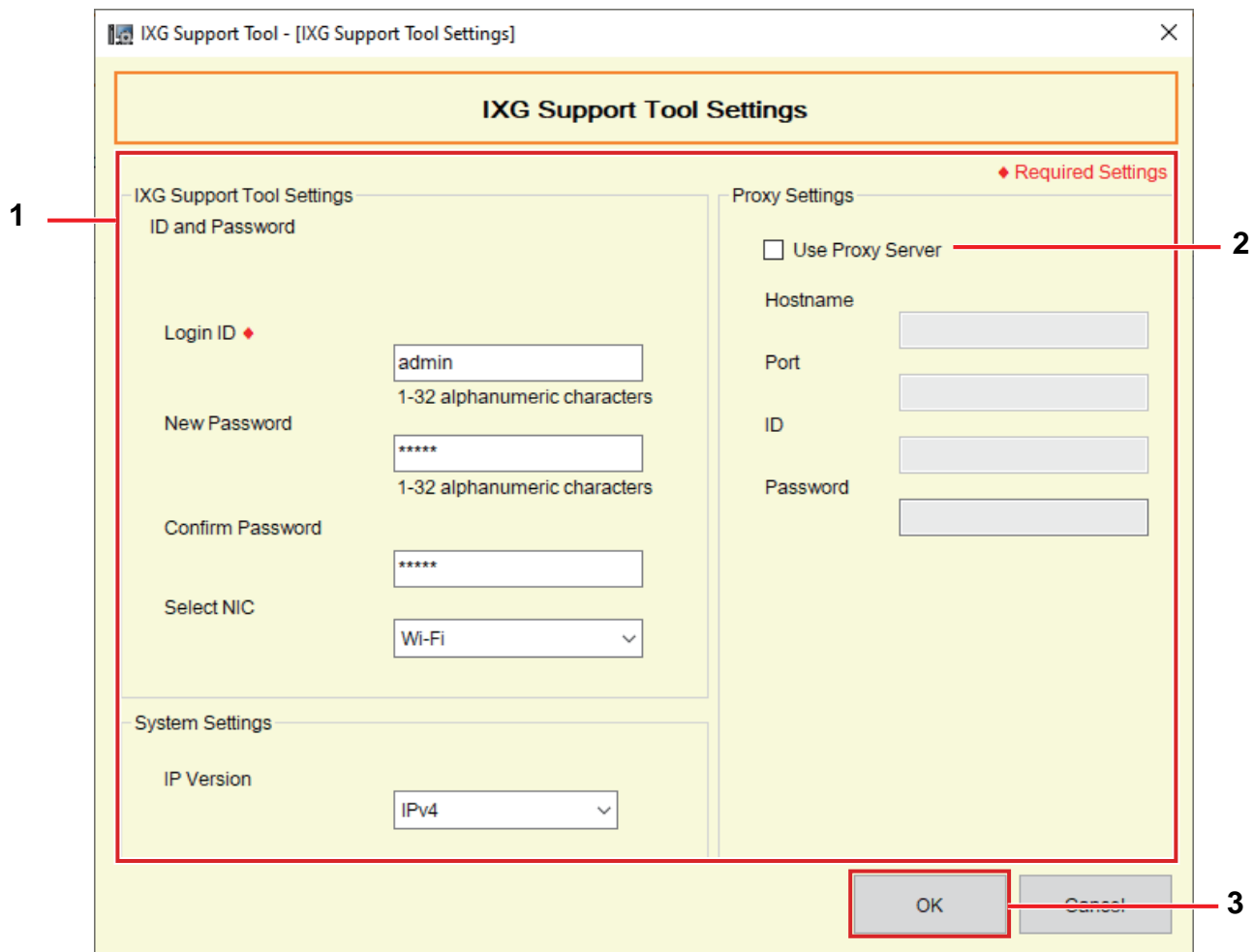

How to configure IXG Support Tool Settings

1. Configure each item.
2. If a proxy server is used to access the IXG Cloud Server, check the "Use Proxy Server" box and enter the required information.
3. Click **[OK]**.
 - Click **[Cancel]** to exit.

■ Login ID ◆

Description	Change the ID to login to the IXG Support Tool.
Settings	1-32 alphanumeric characters

■ New Password

Description	Change the password to login to the IXG Support Tool. Set a password that cannot easily be guessed.
Settings	1-32 alphanumeric characters "admin" cannot be set.

Confirm Password

Description	Enter the "New Password" again.
Settings	1-32 alphanumeric characters "admin" cannot be set.

Select NIC

Description	Select the network interface card (NIC).
Settings	Select the NIC used for the PC.

IP Version

Description	Choose the protocol for IXG Support Tool.
Settings	<ul style="list-style-type: none"> • IPv4 • IPv6

Hostname

Description	Enter the IP address of the proxy server.
Settings	1-255 alphanumeric characters

Port

Description	Enter the port number of the proxy server.
Settings	1 - 65535

ID

Description	Enter the ID used for proxy authentication.
Settings	1-255 alphanumeric characters

Password

Description	Enter the password used for proxy authentication.
Settings	1-255 alphanumeric characters

1.6 Exit

Select "File" - "Exit" to close IXG Support Tool.

2. Connection

2.1 Station Search

Search the stations in IXG and IX Systems connected in the network to show the list.

1. Connect the PC to a network on the same segment as the system.
 - Set this to the same IP version as the system. Refer to ["IXG Support Tool Settings \(→page 65\)"](#) for information of configuring the IP version.

Important

- When searching for IX-SOFT on a PC on which the IXG Support Tool is installed, use a LAN adapter or similar device to search using a NIC other than that of the PC.

2. Select "Connection" - "Station Search". The stations searched are displayed on the "Station Search" screen. (Searching may take several minutes.)
 - The stations without power and the stations in the process of initialization will not be subject to search.
 - Search up to 9999 stations at a time.
 - Click [**Search**] to search again.

Station Search

Search results within the local network.

Station List							
Building Number	Unit Number	Station Name	✓ Station Type	IP Address	MAC Address	Firmware Version	Sub Firmware Version
		IXGW-TGW_10	IXGW-(T)GW	192.168.1.10	00:0B:AA:44:80:19	3.00	
		IXG-DM7-HIDA_121	IXG-DM7(-*)	192.168.1.121	00:0B:AA:41:80:38	3.00	3.00

If multiple NICs are active on this PC, designate the NIC that IXG Support Tool will use in "IXG Support Tool Settings" in the File menu.

2.2 Download Settings

Download settings from a station.

To acquire the settings from IX-SOFT, start IX-SOFT on the PC.

If "Association Settings" are not performed in Administrator mode, downloading is not possible.

Export the IX-SOFT map settings using Map Settings on the respective IX-SOFT.

! Important

- After using the IXG Support Tool to configure a station that supports web configuration, it may not be possible to acquire the setting file if settings were changed using a web browser. In this case, acquire the setting file using a web browser.

Select "Connection" - "Download Settings." The "Setting File Download" screen will be displayed.

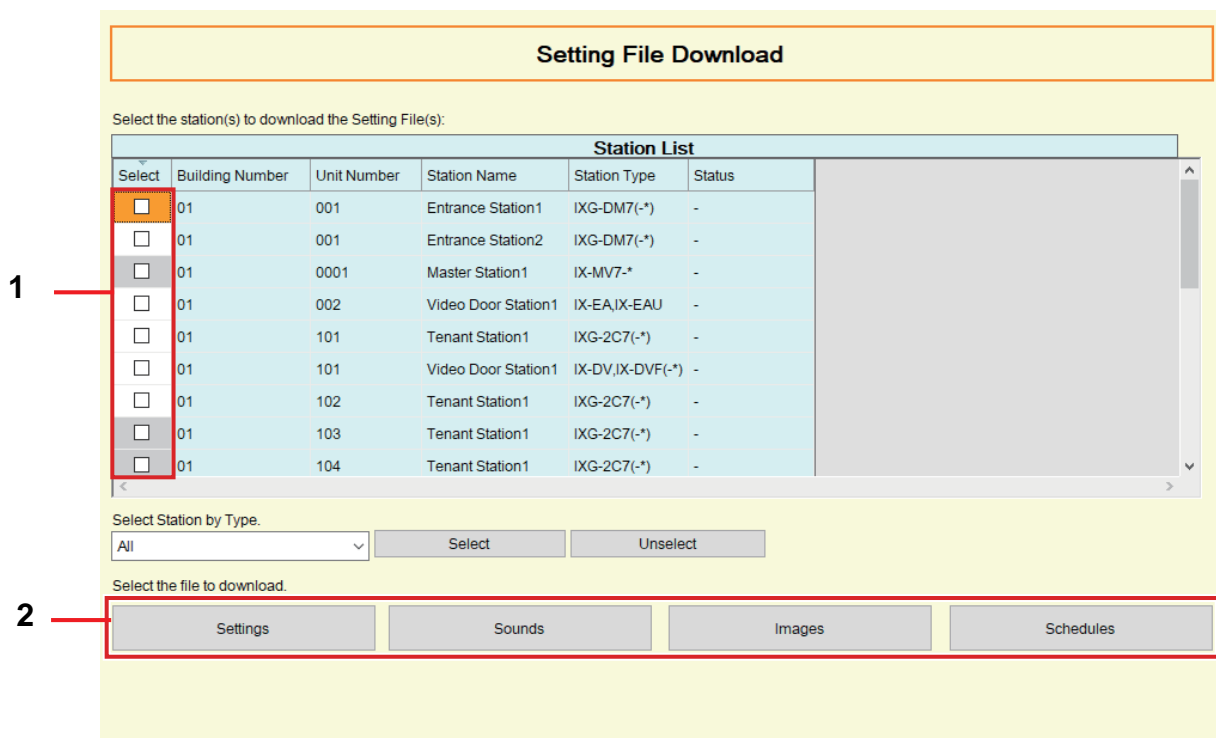

How to obtain settings

1. Select the station from which to download the setting file from "Station List." (Multiple selections allowed.)
 - To select or unselect stations in a batch, choose the station type and click **[Select]** or **[Unselect]**.
 - A station can be selected only if "Association Settings" have been configured for the station in Administrator mode.
2. Download the file.
 - [Settings]**: Download only the setting file.
 - [Sounds]** (except IXG-2C7(-*), IXGW-LC, IXGW-(T)GW, IXW-MA): Download the setting file and audio file for a custom tone.
 - [Images]** (IXG-DM7(-*), IX-MV7-* only): Download the setting file, and the image file for Welcome Screen Settings and the reception screen.
 - [Schedules]** (except IXG-2C7(-*), IX-DA, IX-DB, IX-BA, IX-BB, IXGW-LC, IXGW-(T)GW, IXW-MA): Download transfer and other schedule setting files.

3. Click **[OK]**.

- Click **[Cancel]** to return to the "Setting File Download" screen without downloading.

4. Click **[OK]**.

- The file download result is displayed in "Station List" - "Status."
 - In Process: The file is in the process of downloading.
 - Success: Download is completed.
 - Failed: Download failed. Try downloading again.
 - Unavailable: This is displayed when a file that cannot be uploaded to a station is selected to download in Step 2.
- Downloaded files are saved as follows in "Local Disk (C)" - "users" - "public" - "Documents" - "Aiphone" - "IXG" - "SupportTool" - "SystemData."
 - Setting file: "NewIXSystem(Set Site Name).db"
 - Sound file: Saved as a WAV file in "(Set Site Name)" - "Setting (Hidden Folder)" - "(Station Number)"
 - Image file: Saved as a PNG file in "(Set Site Name)" - "Setting (Hidden Folder)" - "(Station Number)"
 - Schedule file: Saved inside "(Set Site Name)" - "Setting (Hidden Folder)" - "(Station Number)" as "SCHED_CHIME.txt," "SCHED_GROUP.txt," "SCHED_OUTPUT.txt," "SCHED_TRANSFER_DATA.txt," "SCHED_REC.txt," "SCHED_RESTRICTION.txt," "SCHED_UNLOCK_CARD.txt," or "SCHED_TRANSFER.txt" (the saved content differs depending on the station).

2.3 Upload Settings

Upload settings created using IXG Support Tool onto the station.

If "Association Settings" is not performed in Administrator mode, uploading is not possible.

Select "Connection" - "Upload Settings." The "Setting File Upload" screen will be displayed.

! Important

- If a custom tone/image was registered, be sure to upload each file to the station in "Sounds", "Images."
The following will occur if only the setting file is uploaded.
 - The default tone will play when the operation in which the custom tone was set is performed.
 - "Download Settings" will fail.
 - "Upload Settings" will fail.

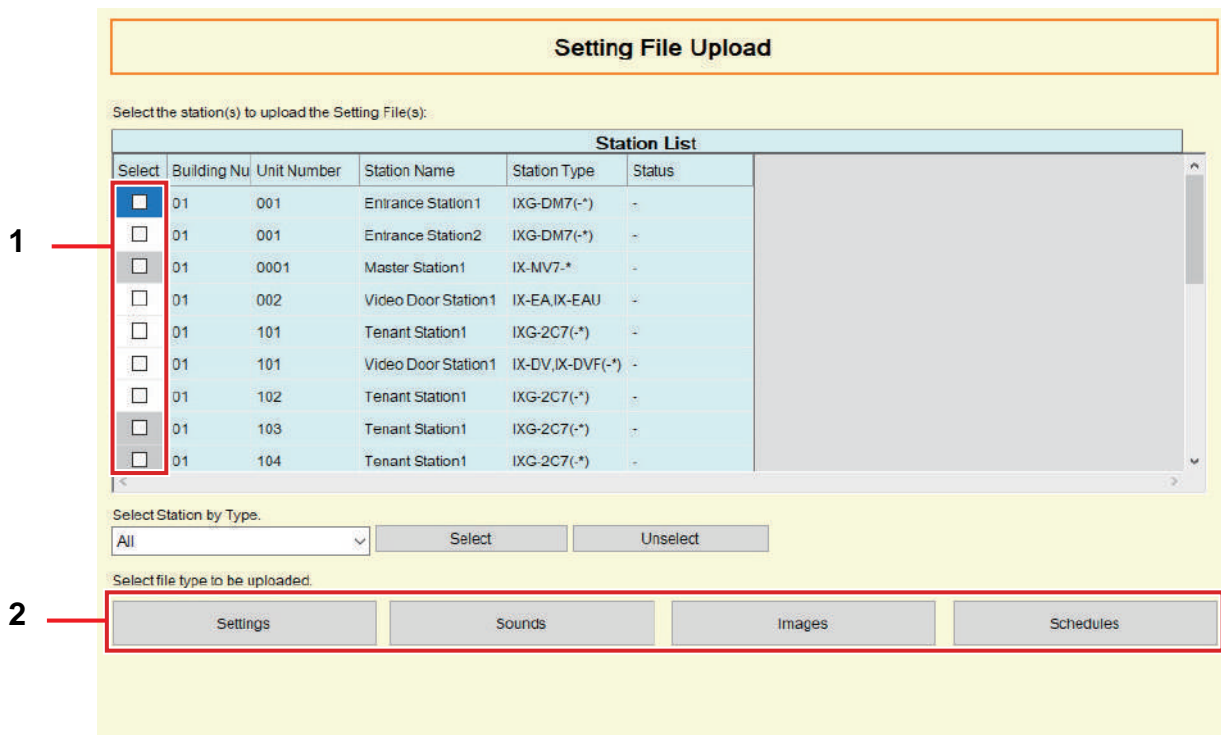

How to upload settings

- 1.** Select the station from which to upload the setting file from "Station List." (Multiple selections allowed.)
 - To select or unselect stations in a batch, choose the type and click **[Select]** or **[Unselect]**.
 - A station can be selected only if "Association Settings" have been configured for the station in Administrator mode.
- 2.** Upload the file.
 - [Settings]**: Upload only the setting file.
 - [Sounds]** (except IXG-2C7(-*), IXGW-LC, IXGW-(T)GW, IXW-MA): Upload the setting file and audio file for a custom tone.
 - [Images]** (IXG-DM7(-*), IX-MV7-* only): Upload the setting file, and the image file for Welcome Screen Settings and the reception screen.
 - [Schedules]** (except IXG-2C7(-*), IX-DA, IX-DB, IX-BA, IX-BB, IXGW-LC, IXGW-(T)GW, IXW-MA): Select transfer and other schedule setting files to upload. Refer to ["How to upload schedules \(→page 73\)"](#).
- 3.** If **[Settings]**, **[Sounds]**, or **[Images]** was clicked, click **[OK]**.
 - Click **[Cancel]** to return to the "Setting File Upload" screen without uploading.
- 4.** Click **[OK]**.
 - The file upload result is displayed in "Station List" - "Status."
 - In Process: The file is in the process of uploading.
 - Success: Upload is completed.
 - Failed: Upload failed. Try uploading again.
 - Unavailable: This is displayed when a file that cannot be uploaded was selected in Step 2.

How to upload schedules

In Step 2 of “[How to upload settings \(→page 72\)](#)”, if [**Schedules**] is clicked, the following screen is displayed.

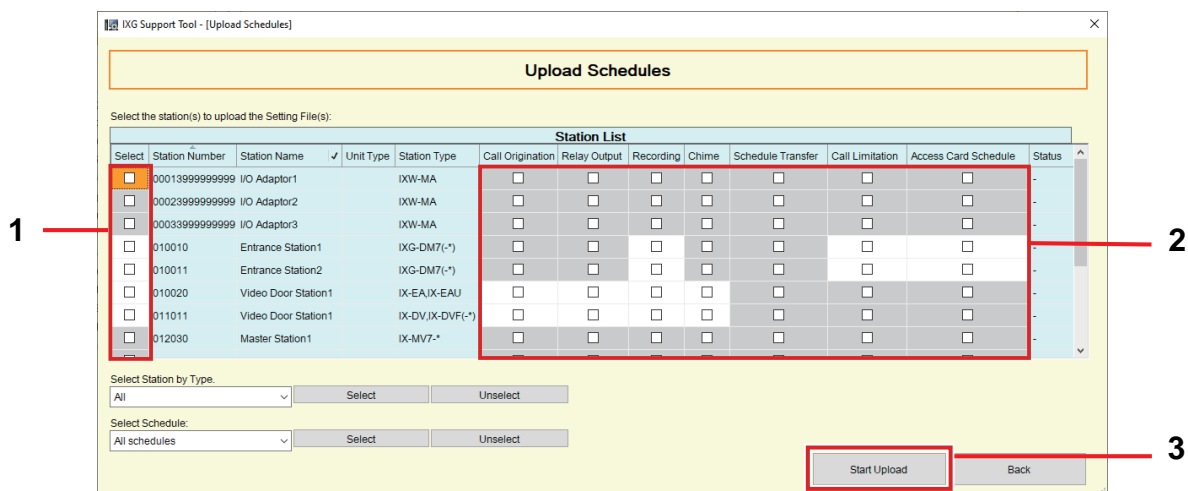

1. Select the station from which to upload the schedule file, from the station list. (Multiple selections allowed.)
 - To select or unselect stations in a batch, choose the station type and click [**Select**] or [**Unselect**].
2. Select the type of schedule file to upload. (Multiple selections allowed.)
 - To select or unselect multiple schedules at once, choose the schedules and click [**Select**] or [**Unselect**].
 - The schedule files that can be selected vary by station.
3. Click [**Start Upload**].
4. Click [**OK**].
 - Click [**Cancel**] to return to the "Upload Schedules" screen without uploading.

2.4 Download Log File

Download log files from IXG-DM7(-*), IXG-MK, IXG-2C7(-*), IXGW-LC, or IXGW-(T)GW.
 If "Association Settings" is not performed in Administrator mode, downloading is not possible.
 Select "Connection" - "Download Log File ." The "Download Log" screen will be displayed.

Select Station(s) to download.

Select	Building Number	Unit Number	Station Name	Station Type	Status
<input type="checkbox"/>	01	001	Entrance Station1	IXG-DM7(-*)	-
<input type="checkbox"/>			IXGW-(T)GW	IXGW-(T)GW	-

Select Station by Type:

How to obtain log files

1. Select the station from which to download the log files from "Station List." (Multiple selections allowed.)
 - To select or unselect stations in a batch, choose the station type and click **[Select]** or **[Unselect]**.
 - A station can be selected only if "Association Settings" have been configured for the station in Administrator mode.
2. Click **[Download]**.
3. Click **[OK]**.
 - Click **[Cancel]** to return to the "Download Log" screen without downloading.
4. Select the folder where the log files are saved and click **[OK]**.
 - A file with the name "Station Number_Date & Time_log.gz" will be created in the specified save directory, and the log files will be saved inside as hidden files.
 - Click **[Cancel]** to return to the "Download Log" screen without saving log files.
 - The file download result is displayed in "Station List" - "Status."
 - In Process: The file is in the process of downloading.
 - Success: Download is completed.
 - Failed: Download failed. Try downloading again.
5. Click **[OK]**.

2.5 Download Access Control Logs File

Obtain access control log files from IXG-DM7(-*).

Select "Connection" - "Download Access Control Log File" to display the "Download/Delete Access Control Log File" screen.

Download/Delete Access Control Log File

Select Station(s) to download from or delete.

Station List					
Select	Building Nu	Unit Number	Station Name	Station Type	Status
<input checked="" type="checkbox"/>	11	001	Entrance Station1	IXG-DM7(-*)	-
<input type="checkbox"/>	11	001	Entrance Station2	IXG-DM7(-*)	-

Select Station by Type: All Select Unselect

Delete Download

How to obtain log files

1. Select the station from which to download the log files from "Station List." (Multiple selections allowed.)
 - To select or unselect multiple stations at once, choose the station type and click **[Select]** or **[Unselect]**.
 - Stations in which "Association Settings" has not been performed in Administrator mode cannot be selected.
2. Click **[Download]**.
3. Click **[OK]**.
 - Click **[Cancel]** to return to the "Download/Delete Access Control Log File" screen without downloading.
4. Select the folder where the log files are saved and click **[OK]**.
 - A file named "Station Number_Date & Time_AccessControlLog.txt" will be created in the specified save directory.
 - Click **[Cancel]** to return to the "Download/Delete Access Control Log File" screen without saving log files.
 - The file download result is displayed in "Station List" - "Status."
 - In Process: The file is in the process of downloading.
 - Success: Download is completed.
 - Failed: Download failed. Try downloading again.
5. Click **[OK]**.

Note

- To delete log files, select a station from "Station List" and then click **[Delete]**.
 - In Process: The file is in the process of being deleted.
 - Success: Deleted.
 - Failed: Unable to delete. Try deleting again.

3. App Integration

3.1 Upload Settings to IXG Cloud Server

If "Number of available Mobile Apps" was changed in "[Units / Stations \(→page 96\)](#)", the following setting data configured in the IXG Support Tool will need to be applied to IXG Cloud Server.

- Building Name
- Unit Name
- Station Name
- Station List
- Mobile App and Phone List

Important

- If the following settings were changed in the IXG Support Tool, apply the changes to IXG Cloud Server.
 - Unit Name "[Units / Stations \(→page 96\)](#)"
 - Station Name "[Identification \(→page 98\)](#)"
 - Station List "[Station List \(→page 104\)](#)"
 - Mobile App and Phone List "[Mobile App and Phone List \(→page 107\)](#)"
 - Guard Button "[Guard Button \(→page 137\)](#)"
 - Door Release QR Code Settings "[Door Release QR Code Settings \(→page 182\)](#)"

Click "App Integration" - "Upload Settings to IXG Cloud Server" to display the "IXG Cloud Server Property Manager Login" screen.

How to upload settings to IXG Cloud Server

1. Enter the "IXG Cloud Server ID or Email Address" and "Password."
2. Click **[Login]**.
 - Login to IXG Cloud Server.
 - Click **[Cancel]** to cancel.

3. Click **[Upload]**.
 - Click **[Cancel]** to cancel.
 - If there is already site information on IXG Cloud Server, select the site and click **[Upload]**.

IXG Support Tool - [Upload Settings to IXG Cloud Server] ✕

Upload Settings to IXG Cloud Server

The site information below will be uploaded.
The settings can only be uploaded from an administrator or property manager account that is linked to the site.

Site ID

Site Name

4. Click **[Agree]**.
- The changes are applied to IXG Cloud Server.
 - Click **[Disagree]** to cancel.

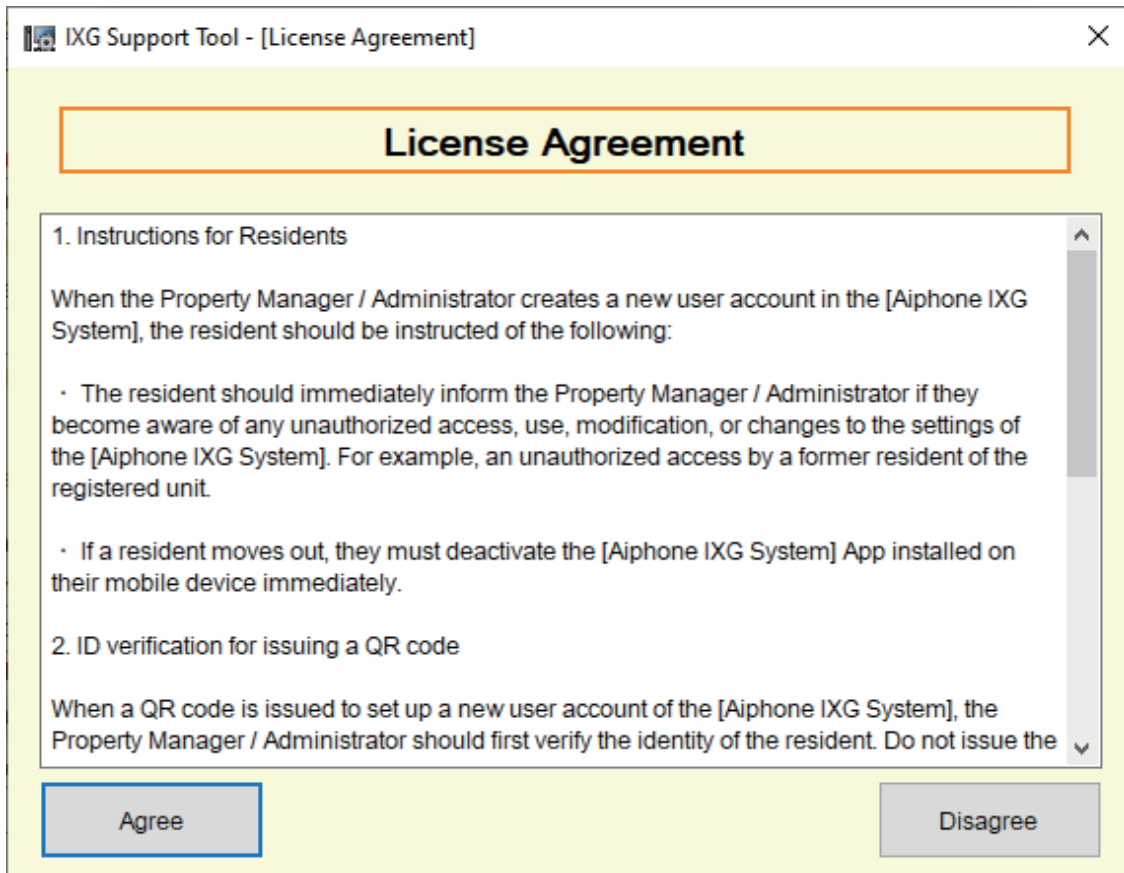

5. Click **[OK]** to send the QR code for app registration to the Tenant Station.
- The QR code for app registration is sent to the Tenant Station. Refer to [“Upload QR Code to the station for App Registration \(→page 79\)”](#) for details.
 - Click **[Cancel]** to cancel.

3.2 Upload QR Code to the station for App Registration

After applying the settings configured with the IXG Support Tool in [“Upload Settings to IXG Cloud Server \(→page 76\)”](#), a QR code for app registration is sent to the Tenant Station. Refer to [“Export QR Code for App Registration \(→page 80\)”](#) if there is no Tenant Station in the residence or if the Intercom App has been registered to a unit other than the residence.

If "Association Settings" is not performed in Administrator mode, settings will not be applied.

Click "App Integration" - "Upload QR Code to the station for App Registration" and login to IXG Cloud Server.

Select	Building Number	Unit Number	Unit Name	Station Number	Station Name	Status	Available App(s)	Status
<input type="checkbox"/>	01	101	Residential101	011010	Tenant Station1	Uploaded	2	
<input checked="" type="checkbox"/>	01	102	Residential102	011020	Tenant Station1	Uploaded	1	Success
<input type="checkbox"/>	01	103	Residential103	011030	Tenant Station1	Association Requirec	1	
<input type="checkbox"/>	01	104	Residential104	011040	Tenant Station1	Association Requirec	1	
<input type="checkbox"/>	01	106	Residential106	011060	Tenant Station1	Association Requirec	0	

How to upload QR Code to the station for App Registration

1. Select the Tenant Station to send the QR code for app registration.
2. Click **[Upload to station(s)]**.
 - The result will be displayed in "Status."
 - In Process: The QR code is being sent.
 - Success: The QR code has been applied.
 - Failed: The QR code has not been applied. Try again.
3. Click **[OK]**.

3.3 Export QR Code for App Registration

After applying the settings configured with the IXG Support Tool in [“Upload Settings to IXG Cloud Server \(→page 76\)”](#), a PDF file containing the QR code for app registration is output. If there is already a Tenant Station in the residence, the QR code for app registration can be sent to the Tenant Station. Refer to [“Upload QR Code to the station for App Registration \(→page 79\)”](#).

If "Association Settings" is not performed in Administrator mode, settings will not be applied. Click "App Integration" - "Export QR Code for App Registration" and login to IXG Cloud Server.

Export QR Code for App Registration

Select	Building Number	Unit Number	Unit Name	Registered Tenant Station	Available App(s)
<input type="checkbox"/>	01	0001	Residential203	0	0
<input type="checkbox"/>	01	101	Residential101	1	2
<input type="checkbox"/>	01	102	Residential102	1	1
<input type="checkbox"/>	01	103	Residential103	1	1
<input type="checkbox"/>	01	104	Residential104	1	1
<input type="checkbox"/>	01	105	Residential105	0	1
<input type="checkbox"/>	01	106	Residential106	1	0
<input type="checkbox"/>	01	201	Guard201	0	1
<input type="checkbox"/>	01	202	Commercial202	0	0
<input type="checkbox"/>	01	207	Outside Area 207	0	0
<input type="checkbox"/>	01	208	Residential208	0	0
<input type="checkbox"/>	01	209	Residential209	0	0
<input type="checkbox"/>	01	210	Residential210	0	0

How to export QR code for app registration

1. Select the unit to register the Intercom App.
2. Click **[Export QR Code for App Registration]**.
3. Specify the save directory and click **[OK]**.
 - A file with the name "(Building Number)_(Unit Number)" will be saved in the specified directory.
4. Click **[OK]**.

3.4 Site List

Check the list of sites that are being managed.
Click "App Integration" - "Site List" and login to IXG Cloud Server.

How to configure Site List Settings

1. Enter the "IXG Cloud Server ID or Email Address" and "Password."
2. Click **[Login]**.
 - Login to the IXG Cloud Server.
 - Click **[Cancel]** to exit IXG Cloud Server Login.
3. Check the site list.
 - Click **[Close]** to finish configuring the Site List / Property Manager Account Settings.

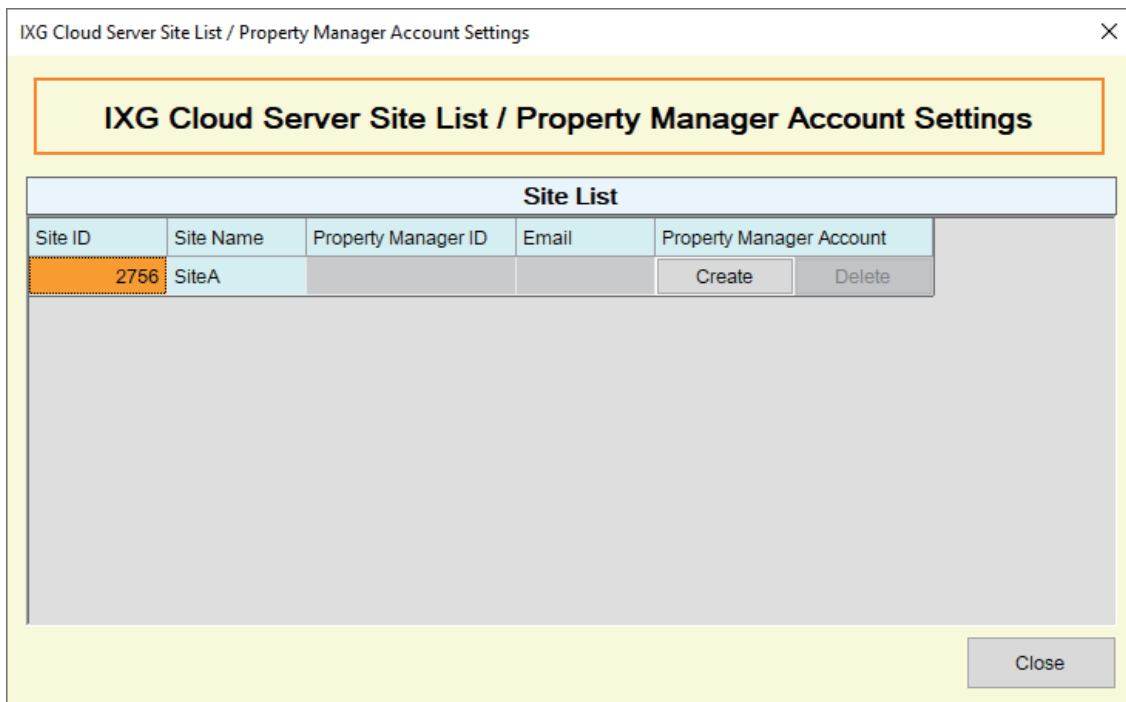

3.5 Property manager Account Settings

Change the email address and password that are registered for the property manager.

Configure this if you want to change the registered email address or password.

Click "App Integration" - "Property manager Account Settings" and login to IXG Cloud Server.

How to configure the property manager account settings

1. Enter the "IXG Cloud Server ID or Email Address" and "Password."
2. Click **[Login]**.
 - Login to the IXG Cloud Server.
 - Click **[Cancel]** to exit.
3. Change the following information if required.
 - Change Email Address: Enter the new email address and click **[Change Email Address]**. (Email: 1-64 alphanumeric characters)
 - Change Password: Enter the current and new passwords, and then click **[Change Password]**. (8-22 characters [must include uppercase letters, lowercase letters, and numbers].)
 - Click **[Close]** to finish configuring the property manager account settings.
4. If **[Change Email Address]** was clicked in Step 3, an email containing the Verification Code will be sent to the registered email address.
Click **[OK]**.
5. Enter the received "Verification Code" and then click **[Activate]**.
 - Clicking **[Resend]** resends the verification code.
 - Click **[Cancel]** to exit.
6. Click **[OK]**.

3.5.1 Password Recovery

If you forgot the password used to login to IXG Cloud Server, the password can be reset.

How to recover a password

1. Click [***Forgot password?]** on the "IXG Cloud Server Property Manager Login" screen.
2. Enter "IXG Cloud Server ID or Email Address" and click [**Send Email**].
 - An email containing the Verification Code will be sent either to the email address associated with the IXG Cloud Server ID or to the email address that was entered.
 - Click [**Cancel**] to quit without resetting the password.

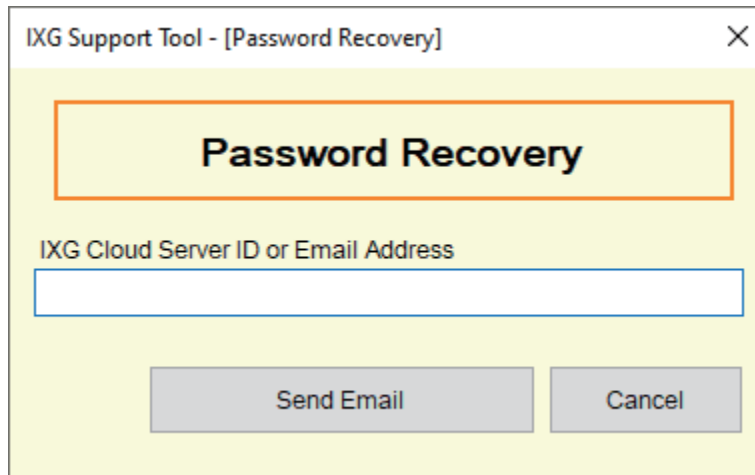

 **Note**

- Input the Email Address which is registered in the IXG Cloud Server for the Email Address.

3. Click [**OK**].

4. Enter the following information.
 - Verification Code: Enter the "Verification Code" contained in the email.
 - New Password: 8-22 characters (must include uppercase letters, lowercase letters, and numbers; set a password that cannot easily be guessed).
 - Confirm Password: Enter the same password again.

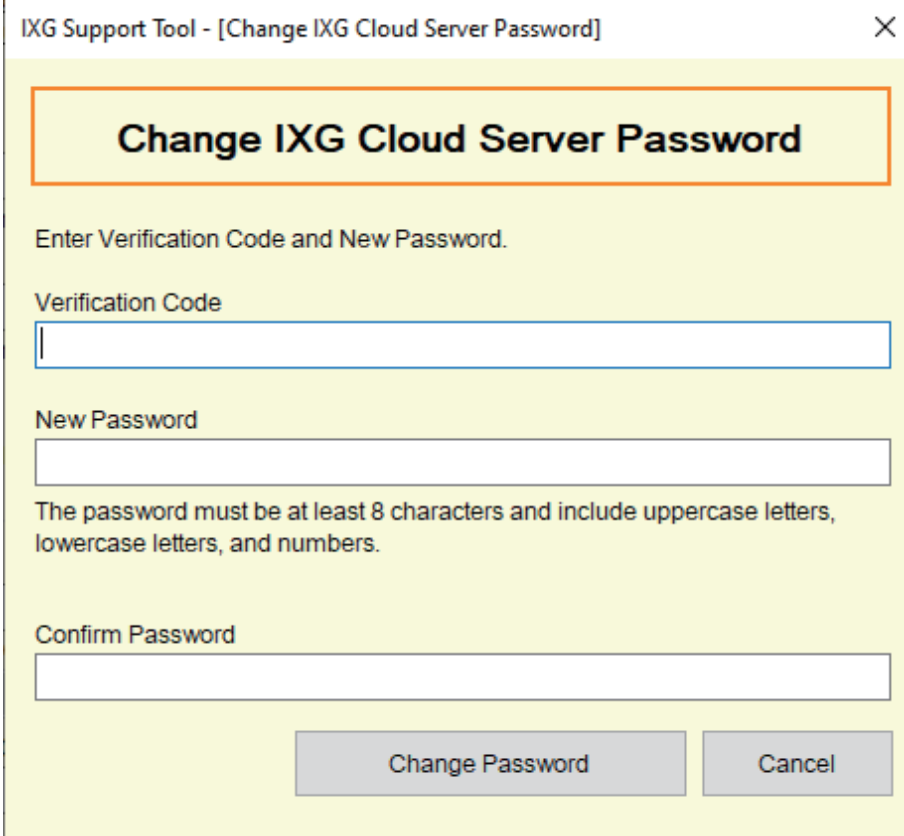

The screenshot shows a dialog box titled "IXG Support Tool - [Change IXG Cloud Server Password]". The dialog has a yellow background and a title bar with a close button (X). The main content area is titled "Change IXG Cloud Server Password" in bold black text. Below the title, it says "Enter Verification Code and New Password." There are three input fields: "Verification Code", "New Password", and "Confirm Password". Below the "New Password" field, there is a note: "The password must be at least 8 characters and include uppercase letters, lowercase letters, and numbers." At the bottom of the dialog, there are two buttons: "Change Password" and "Cancel".

5. Click **[Change Password]**.
 - The password will be changed.
 - Click **[Cancel]** to exit.
6. Click **[OK]**.

3.6 Manual IXG Cloud Server and Gateway Sync

If the app integration function is not working properly, synchronize the settings of the Gateway Adaptor and the IXG Cloud Server.

! Important

- The Gateway Adaptor can be configured only if "Association Settings" have been configured in Administrator mode, and the PC can communicate with the system.

Click "App Integration" - "Manual IXG Cloud Server and Gateway Sync" to display the following screen.

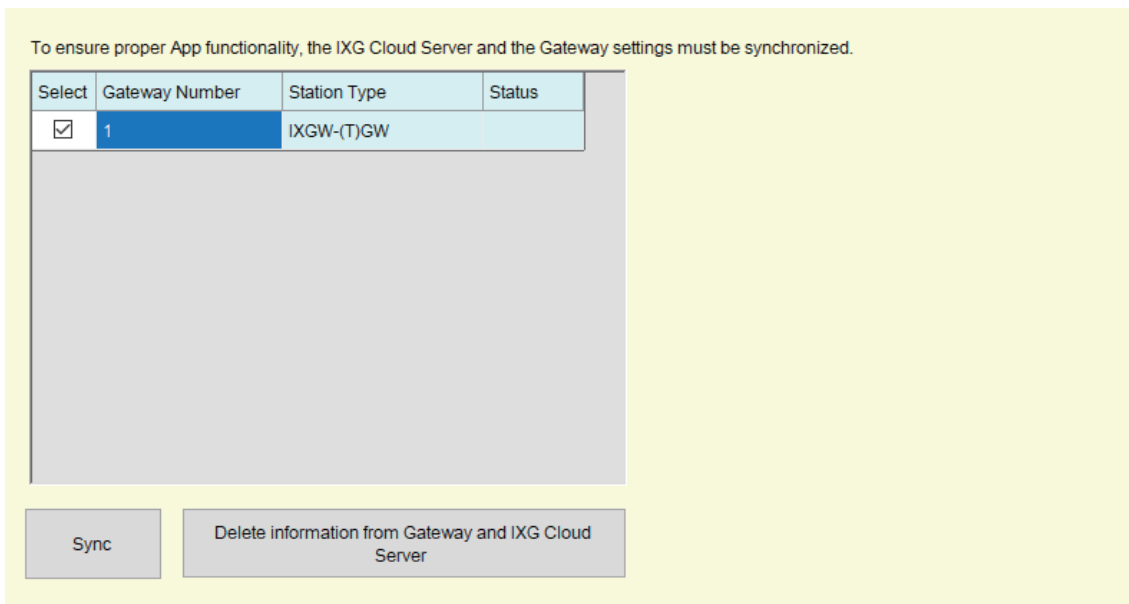

Manual IXG Cloud Server and Gateway Sync

1. Select the Gateway Adaptor to synchronize with the IXG Cloud Server.
2. Click **[Sync]**.
 - The IXG Cloud Server and the Gateway Adaptor will be synchronized.
 - The file synchronization result is displayed in "Status."
 - In Process: Currently synchronizing.
 - Success: Synchronization successful.
 - Failed: Synchronization failed. Try synchronizing again.

How to delete linked information from the Gateway and the IXG Cloud Server

If app integration will no longer be used, delete the gateway information from the IXG Cloud Server and the IXG Cloud Server information from the gateway.

1. Select the Gateway Adaptor for which to delete the link.
2. Click **[Delete information from Gateway and IXG Cloud Server]**.
 - The gateway information is deleted from the IXG Cloud Server, and the IXG Cloud Server information is deleted from the gateway.
 - The result is displayed in "Status."
 - Success: Linked information has been deleted.
 - Failed: Linked information has not been deleted, try again.

4. Tools

4.1 Message Management

Messages can be sent to an IXG-2C7(-*) or an Intercom App registered to a residence.

Click "Tools" - "Message Management" and login to the IXG Cloud Server.

The message list will be displayed.

["How to create a message \(→page 87\)"](#)

Displayed messages
Up to 100 messages can be displayed at a time.
Switch the screen as follows.
[Previous]: Display the previous 100.
[Next]: Display the next 100.

Display Page
Specify the page to display.

IXG Support Tool - [Message Management]

Message Management

New Message

Message List

Sent Status	Read Status	Sent Date	Destination	Subject	Details
✓	-	8/23/2023 11:05 AM	Building	Lost and Found	Details
✓	-	8/23/2023 11:04 AM	Unit	Entranceway Construction	Details
✓	-	8/23/2023 11:03 AM	Building	About the courier company	Details
✓	-	8/23/2023 11:03 AM	Building	Mail management	Details
✓	-	8/23/2023 11:02 AM	Building	Cleaning work performed	Details
✓	-	8/23/2023 11:01 AM	Building	Water Supply Inspection Notice	Details
✓	-	8/23/2023 11:01 AM	Unit	Luggage storage	Details
✓	-	8/23/2023 11:00 AM	Building	Gas Inspection Notice	Details
✓	-	8/23/2023 10:59 AM	Building	Notice of Disaster Drill	Details
✓	-	8/23/2023 10:57 AM	Building	Board of Directors Meeting	Details

Sent Status ✓ : Success ▲ : Partially Sent ✗ : Failed
Read Status ✓ : Read ▲ : Partially Read

Display Page 1 / 1 Apply

Displayed Messages 1-10/10 Previo Next

Update Status Close

Update status

Details
["Message Details screen user interface \(→page 88\)"](#)

The following information is displayed.

- Sent Status: Displays destination information.
 - ✓: Sent to all stations.
 - ▲: Unable to send to some stations.
 - ✗: Unable to send to any stations.
- Read Status: Displays read status, as well as the date and time when the message was first read on the station in the residence.
 - ✓: Read by all stations.
 - ▲: Not read by some stations.
 - Blank: Not read by any stations.
- Sent Date: Displays the sent date and time.

- Destination: Displays the destination type (building or unit).
- Subject: Displays the subject line of the message.
- Details: Click **[Details]** to display the "Message Details" screen. Refer to ["Message Status Station Details screen user interface \(→page 89\)"](#) for details.

How to create a message

1. Click "New Message."
 - The "New Message" screen is displayed.
2. Click **[Destination]** to select where to send the message. (Select Building(s), Select Unit(s))
 - To select or unselect multiple destinations at once, click **[Select]** or **[Unselect]**.
3. Click **[OK]**.
 - Click **[Close]** to return to the "New Message" screen without setting a destination.
4. Select "Language."
 - Language: Japanese, English, French, Spanish, Dutch, Traditional Chinese, Simplified Chinese, German, Italian, Norwegian, Finnish, Turkish
5. Enter the following information:
 - Subject: Up to 40 characters
 - Message: Up to 2000 characters
6. To attach and send an image, click **[Browse]** and select the image to attach.
 - Click **[Preview]** to check the set image.
 - To delete the set image, click **[Delete]**.
 - Image attachment requirements:
 - Format: png
 - Resolution (WxH): 560x420 pixels
 - File size: 500 KB or less
7. Click **[Send]** to send the message to the set destination(s).
 - The "Message List Details" screen is displayed.



Note

- If the image's resolution differs from the specified size, the image will be resized to fit.
- If the size of the image file exceeds 500 KB, colors will be reduced to lower the image size to 500 KB. Files smaller than 500 KB may also have colors reduced, depending on the image. This may cause image deterioration or render text in the image illegible.
- If the number of messages reaches 9,999, messages will begin being deleted starting from oldest message (based on date and time sent).
- It may take longer to send messages to multiple stations.

Message Details screen user interface

Click **[Details]** in the "Message List" on the "Message Management" screen, or click **[Send]** on the "New Message" screen to display the "Message Details" screen.

The screenshot shows the 'Message Details' screen in the IxG Support Tool. It includes a header with the title 'Message Details', a form for message details (Sent Date, Language, Subject, Body), and a table of message status for various units. Callouts point to specific features: 'Displays sent message details.' points to the message details form; 'Update status' points to the 'Update Status' button; 'Delete' points to the 'Delete' button; 'Resend to stations with a "Failed" Sent Status' points to the 'Resend to stations with a "Failed" Sent Status' button; and 'Copy Message' points to the 'Copy Message' button.

Update status
Update with the latest information.

Delete
Delete a message from IxG Support Tool, IxG-2C7(-*), or Intercom App.

Resend to stations with a "Failed" Sent Status
Resend message to stations that did not receive message.

Copy Message
Copy the displayed message and create a new message.

Building Nu	Unit Number	Unit Name	Sent Status	Read Status	Status	Resend
01	101	Residential 101	▲ Details	-	Failed to Send	Resend
01	102	Residential 102	✖ Details	-	Failed to Send	Resend
01	103	Residential 103	✔ Details	-	Sent Successfully	Resend
01	104	Residential 104	✔ Details	-	Sent Successfully	Resend
01	105	Residential 105	✔ Details	-	Sent Successfully	Resend

The following information is displayed.

- Building Number, Unit Number, Unit Name: Displays destination information.
- Sent Status: Displays the sending status. Click **[Details]** to check the sending status for each station belonging to each unit.
Click **[Details]** to display the "Message Status Station Details" screen. Refer to ["Message Status Station Details screen user interface \(→page 89\)"](#) for details.
 - ✓: Sent to all stations.
 - ▲: Unable to send to some stations.
 - ✖: Unable to send to any stations.
- Read Status: Displays read status, as well as the date and time when the message was first read on the station.
 - ✓: Read by all stations.
 - ▲: Not read by some stations.
 - Blank: Not read by any stations.
- Status: Displays the processing status.
 - Read Status Update Successful

- No messages
- Failed to Acquire Read Status
- Failed to delete message
- Sent Successfully
- Failed to Send
- Resend: Click **[Resend]** to resend the message.

Message Status Station Details screen user interface

Click **[Details]** on "Sent Status" in "Message Details" to display the "Message Status Station Details" screen.

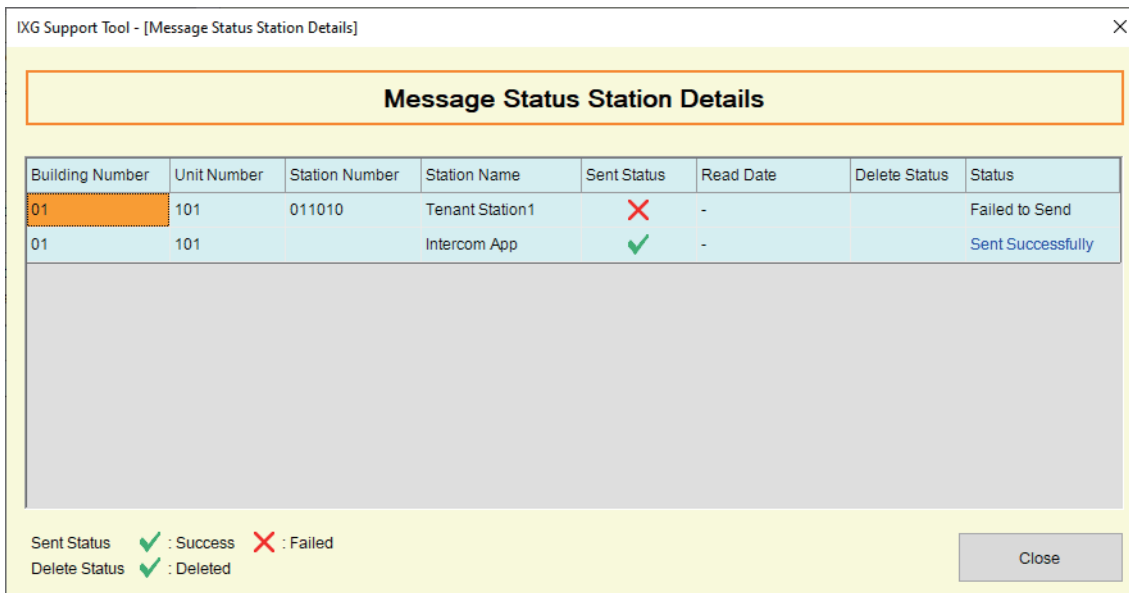

The following information is displayed.

- Building Number, Unit Number, Station Number, Station Name: Displays destination station information.
- Sent Status: Displays the sending status for each station.
 - ✔: Sent.
 - ✘: Unable to send.
- Read Date: Displays the date and time when the message was read.
- Delete Status: Displays the processing status.
 - ✔: Message deleted.
 - Blank: Message not deleted.
- Status: Displays the processing status.
 - Read Status Update Successful
 - No messages
 - Failed to Acquire Read Status
 - Failed to delete message
 - Sent Successfully
 - Failed to Send

 **Note**

- This is displayed on a single row as "Intercom App," even if multiple Intercom Apps are registered to the same residence.

5. View

Switch to Administrator Settings (Administrator mode).

For information on Administrator mode, refer to the separate "IXG Support Tool Setting Manual: Administrator Mode."

6. Language

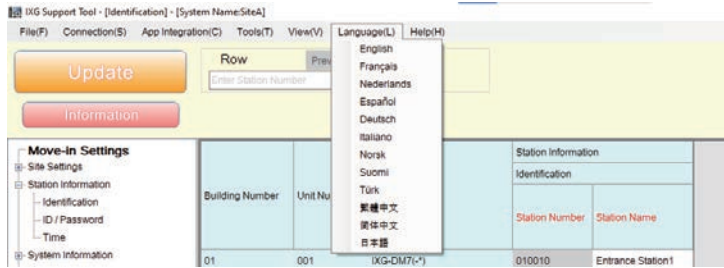

Set the language of the following items.

- The display content of the IXG Support Tool.
- The language used to enter setting data (Units / Stations, etc.)
- The content of email message.

! Important

- The language used on each station can be changed on the Settings screen of each station.
- If the language (configured on the station main unit) displayed on the screen for IXG-2C7(-*), IX-MV7-*, IXG-MK, IX-SOFT, IXG-DM7(-*), or Intercom App is different from the language set with "Language," text may appear incorrectly. To avoid this, enter information in the setting data using alphabetical characters only.

7. Help

7.1 About

Click "Help" - "About" to display the "About" screen.

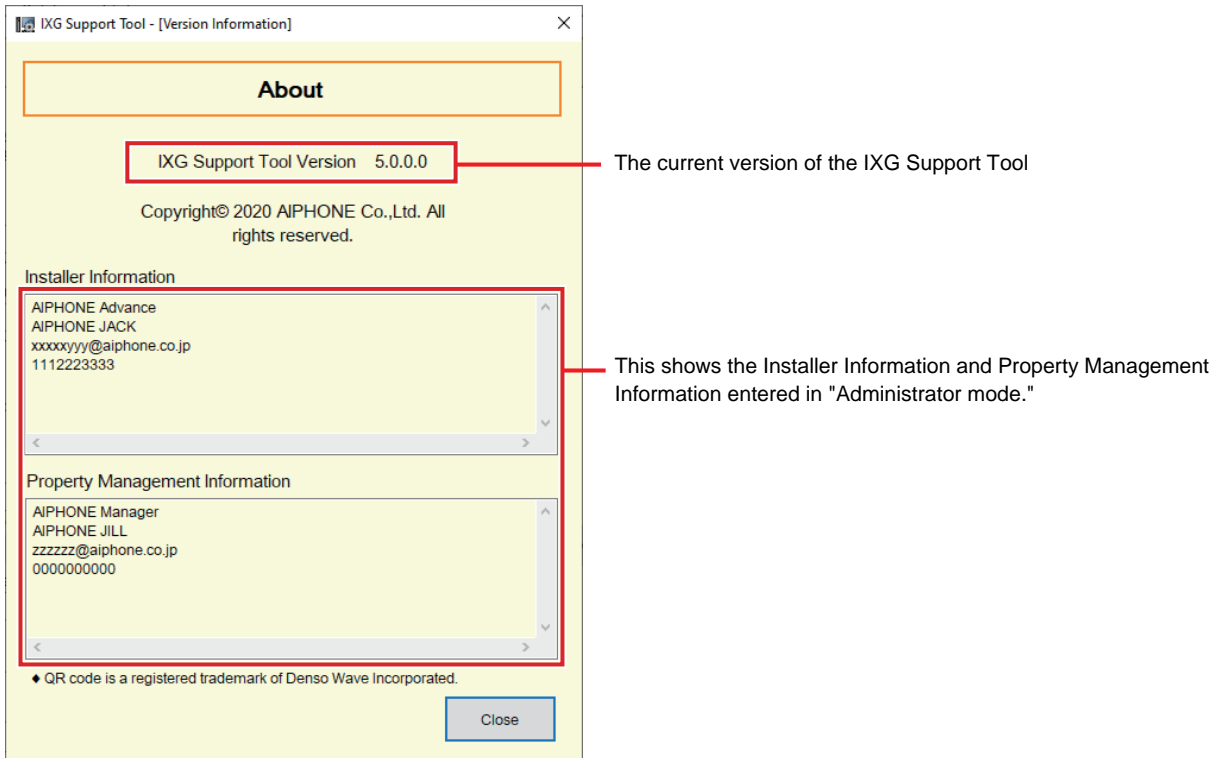

Click **[Close]** to close the "About" screen.

7.2 Download IXG Support Tool Log File

Click "Help" - "Download IXG Support Tool Log File" to display the "Download IXG Support Tool Log File" screen.

Download IXG Support Tool Log File

Designate a folder to download the IXG Support Tool Log File to.

Browse 1

Download 2

How to obtain log files

1. Click **[Browse]** and select the folder to output log files.
2. Click **[Download]**.
3. Click **[OK]**.
 - A file named "AIPHONE_IXG_SupportTool_log_Date & Time.zip" is created in the selected folder, and contains the log files.

System Settings

Important

- Depending on the display language of the Station (IXG-2C7(-*), IX-MV7-*, IXG-MK, IX-SOFT, IXG-DM7(-*), Intercom App), the settings may appear incorrectly.
- The symbols indicate the following:
 - ◆: Be sure to enter a setting value. Use the default values, unless a change is necessary.

1. Site Settings (Move-in Settings)

1.1 Building Information

Configure the name of the building to register to the system.

■ Building Name ◆

Description	Configure the name of the building. The set building name will be used when specifying a destination on a Entrance Station or Guard Station.
Settings	1-24 alphanumeric characters, space, symbols ("!\$%()./:;?@_+) If information other than the above are input, the input information will become blank or the characters may appear incorrectly when the display language was changed on Entrance Station.

1.2 Units / Stations

Configure common area and private area information.
 The numbers of stations that can be registered is as follows.

- Intercom App: Up to 8 each in 9,999 units total
- Phone (device using a phone number): Up to 9,999 total

Register IXG and IX stations in Administrator mode.

Filter
 Building Number / Building Name: Select a building to display and then click **[Apply]** to display only the selected building.
 Unit Type: Select a location to display and then click **[Apply]** to display only the selected location.

Display Settings
 Check the display settings box, select the number to display for each station, and then click **[Apply]**.

Building Number	Unit Number	Unit Type		Unit Name	First Name	Last Name	Phone Registration	Master / Tenant Station 1
01	001	Entrance	Select	Entrance001				
01	0001	Commercial	Select	Residential203			Disable	IX-MV7-*
01	0002	Outside Area	Select	Outside Area 0002				
01	101	Residential	Select	Residential101			Enable	IXG-2C7(-*)
01	102	Residential	Select	Residential102			Disable	IXG-2C7(-*)
01	103	Residential	Select	Residential103			Disable	IXG-2C7(-*)
01	104	Residential	Select	Residential104			Disable	IXG-2C7(-*)
01	105	Residential	Select	Residential105			Disable	
01	106	Residential	Select	Residential106			Disable	IXG-2C7(-*)
01	201	Guard	Select	Guard201			Disable	IXG-MK
01	202	Commercial	Select	Commercial202			Disable	IX-MV7-*

! Important

- “[Language \(→page 91\)](#)” must be set before continuing.
- Enter using the language set in “[Language \(→page 91\)](#)”. However, if the language (configured on the station main unit) displayed on the screen for IXG-2C7(-*), IXG-MK, IX-MV7-*, IX-SOFT, IXG-DM7(-*), or Intercom App is different from the language set with “[Language \(→page 91\)](#)”, text displayed on the station screen may appear incorrectly. To avoid this, enter information using alphabetical characters only.

■ Unit Name◆

Description	Configure the name of the unit. The Unit Name that was entered will be shown to the caller when calling. (Guard, Inside Area , Commercial only) The Unit Name that was entered will be displayed on the selection button shown on the Search by List Screen on the Entrance Station. (Guard, Inside Area , Commercial only)
Settings	1-24 alphanumeric characters

■ First Name

Description	<p>Enter the first name.</p> <p>The First Name will be displayed on the selection button of the Search by List Screen on the Entrance Station.</p> <p>This is also used to search for a destination on the Entrance Station.</p>
Settings	<p>1-16 alphanumeric characters, space, symbols ("!\$%()./:;?@_+)</p> <p>If information other than the above are input, the input information will become blank or the characters may appear incorrectly when the display language was changed on the Entrance Station.</p>

■ Last Name

Description	<p>Enter the last name.</p> <p>The Last Name will be displayed on the selection button of the Search by List Screen on the Entrance Station.</p> <p>This is also used to search for a destination on the Entrance Station.</p>
Settings	<p>1-16 alphanumeric characters, space, symbols ("!\$%()./:;?@_+)</p> <p>If information other than the above are input, the input information will become blank or the characters may appear incorrectly when the display language was changed on the Entrance Station.</p>



Note

- Only alphanumeric characters can be used for the "First Name" and "Last Name" when using "Search by Name" on an entrance station.

■ Phone Registration (Guard, Commercial, Residential only)

Description	<p>Configure whether to use a phone.</p> <p>To use a phone, register the phone number in "Telephone Entry Settings (→page 143)".</p>
Settings	<ul style="list-style-type: none"> • Enable • Disable

■ Number of available Mobile Apps (Guard, Commercial, Residential only)

Description	<p>Set the number of Intercom Apps to register to Guard, Commercial, or Residential.</p> <p>Up to 8 Intercom Apps can be registered in each unit.</p>
Settings	<p>0 - 8</p>

2. Station Information (Move-in Settings)

2.1 Identification

Configure the Station Number and Station Name of the station to register in the system.

Move row

Up to 50 station number rows can be displayed at a time. Switch the screen as follows.

[Previous]: Display the previous 50 rows.

[Next]: Display the next 50 rows.

[Apply]: Enter the station number and click **[Apply]** to move the cursor to the row of the station number that was entered.

Row Previous Next
 Apply

Building Number	Unit Number	Station Type	Station Information	
			Identification	
			Station Number	Station Name
01	001	IXG-DM7(-*)	010010	Entrance Station1
01	001	IXG-DM7(-*)	010011	Entrance Station2
01	0001	IX-MV7-*	012030	Master Station1

! Important

- Always set "[Language \(→page 91\)](#)" before setting "Identification."
- Enter using the language set in "[Language \(→page 91\)](#)". However, if the language (configured on the station main unit) displayed on the screen for IXG-2C7(-*), IXG-MK, IX-MV7-*, IXG-DM7(-*), Intercom App, or IX-SOFT is different from the language set with "[Language \(→page 91\)](#)", text displayed on the station screen may appear incorrectly. To avoid this, enter information using alphabetical characters only.
- Results when searching by station will be listed in order of station number.

■ Station Number ◆

Compatible type	<input checked="" type="checkbox"/> IXG-2C7(-*) <input checked="" type="checkbox"/> IXG-MK <input checked="" type="checkbox"/> IX-MV7-* <input checked="" type="checkbox"/> IXG-DM7(-*) <input checked="" type="checkbox"/> IX-DA, IX-DB <input checked="" type="checkbox"/> IX-BA, IX-BB <input checked="" type="checkbox"/> IX-DV, IX-DVF(-*) <input checked="" type="checkbox"/> IX-SSA(-*) <input checked="" type="checkbox"/> IX-EA, IX-EAU <input type="checkbox"/> IX-FA <input checked="" type="checkbox"/> IXGW-LC <input checked="" type="checkbox"/> IXGW-(T)GW <input checked="" type="checkbox"/> Intercom App <input checked="" type="checkbox"/> IX-SS-2G <input checked="" type="checkbox"/> IX-RS-* <input checked="" type="checkbox"/> IX-SOFT <input checked="" type="checkbox"/> IXW-MA <input type="checkbox"/> IX-SPMIC <input checked="" type="checkbox"/> VoIP Phone <input checked="" type="checkbox"/> IX-DVM
Description	Set the station number. The unit number must be unique. The station number must not be used on any other station. The set station number will be shown to the recipient when calling or paging. Settings can be configured for Intercom App only. Use Administrator mode for other stations.
Settings	3-24 digits

■ Station Name◆

Compatible type	<input checked="" type="checkbox"/> IXG-2C7(-*) <input checked="" type="checkbox"/> IXG-MK <input checked="" type="checkbox"/> IX-MV7-* <input checked="" type="checkbox"/> IXG-DM7(-*) <input checked="" type="checkbox"/> IX-DA, IX-DB <input checked="" type="checkbox"/> IX-BA, IX-BB <input checked="" type="checkbox"/> IX-DV, IX-DVF(-*) <input checked="" type="checkbox"/> IX-SSA(-*) <input checked="" type="checkbox"/> IX-EA, IX-EAU <input type="checkbox"/> IX-FA <input checked="" type="checkbox"/> IXGW-LC <input checked="" type="checkbox"/> IXGW-(T)GW <input checked="" type="checkbox"/> Intercom App <input checked="" type="checkbox"/> IX-SS-2G <input checked="" type="checkbox"/> IX-RS-* <input checked="" type="checkbox"/> IX-SOFT <input checked="" type="checkbox"/> IXW-MA <input type="checkbox"/> IX-SPMIC <input checked="" type="checkbox"/> VoIP Phone <input checked="" type="checkbox"/> IX-DVM
Description	Set the station name. The set station name will be shown to the recipient when calling, etc. This is also used when searching stations by station number on IX-MV7-*, etc.
Settings	1-24 alphanumeric characters

2.2 ID / Password

Set an ID and password used when communicating with a station, such as when applying settings to the station.

Move row

Up to 50 station number rows can be displayed at a time. Switch the screen as follows.

[Previous]: Display the previous 50 rows.

[Next]: Display the next 50 rows.

[Apply]: Enter the station number and click **[Apply]** to move the cursor to the row of the station number that was entered.

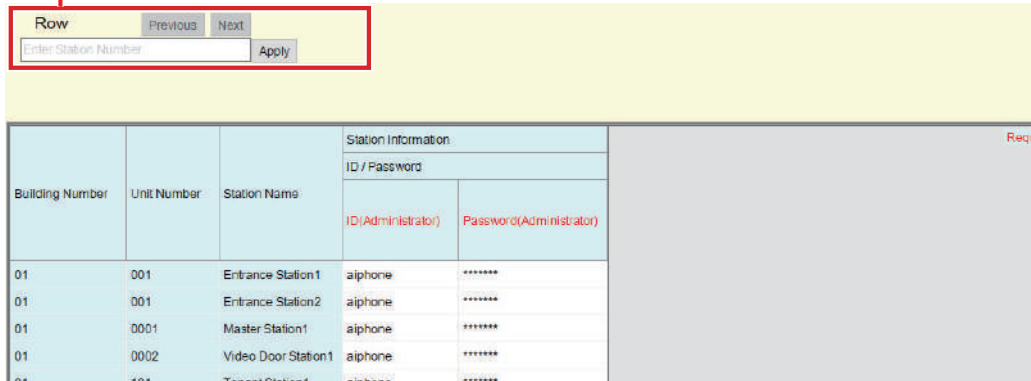

■ ID(Administrator)◆

Compatible type	<input checked="" type="checkbox"/> IXG-2C7(-*) <input checked="" type="checkbox"/> IXG-MK <input checked="" type="checkbox"/> IX-MV7-* <input checked="" type="checkbox"/> IXG-DM7(-*) <input checked="" type="checkbox"/> IX-DA, IX-DB <input checked="" type="checkbox"/> IX-BA, IX-BB <input checked="" type="checkbox"/> IX-DV, IX-DVF(-*) <input checked="" type="checkbox"/> IX-SSA(-*) <input checked="" type="checkbox"/> IX-EA, IX-EAU <input type="checkbox"/> IX-FA <input checked="" type="checkbox"/> IXGW-LC <input checked="" type="checkbox"/> IXGW-(T)GW <input type="checkbox"/> Intercom App <input checked="" type="checkbox"/> IX-SS-2G <input checked="" type="checkbox"/> IX-RS-* <input checked="" type="checkbox"/> IX-SOFT <input checked="" type="checkbox"/> IXW-MA <input type="checkbox"/> IX-SPMIC <input type="checkbox"/> VoIP Phone <input checked="" type="checkbox"/> IX-DVM
Description	Set an ID used when communicating with a station, such as when applying settings to the station. For IX-MV7-*, IXG-MK, and IX-SOFT, configure the property manager ID used to login to the setting mode from the above and the station main unit (application) screen.
Settings	1-32 alphanumeric characters Cannot be set to "admin" or "root."

■ Password(Administrator)◆

Compatible type	<input checked="" type="checkbox"/> IXG-2C7(-*) <input checked="" type="checkbox"/> IXG-MK <input checked="" type="checkbox"/> IX-MV7-* <input checked="" type="checkbox"/> IXG-DM7(-*) <input checked="" type="checkbox"/> IX-DA, IX-DB <input checked="" type="checkbox"/> IX-BA, IX-BB <input checked="" type="checkbox"/> IX-DV, IX-DVF(-*) <input checked="" type="checkbox"/> IX-SSA(-*) <input checked="" type="checkbox"/> IX-EA, IX-EAU <input type="checkbox"/> IX-FA <input checked="" type="checkbox"/> IXGW-LC <input checked="" type="checkbox"/> IXGW-(T)GW <input type="checkbox"/> Intercom App <input checked="" type="checkbox"/> IX-SS-2G <input checked="" type="checkbox"/> IX-RS-* <input checked="" type="checkbox"/> IX-SOFT <input checked="" type="checkbox"/> IXW-MA <input type="checkbox"/> IX-SPMIC <input type="checkbox"/> VoIP Phone <input checked="" type="checkbox"/> IX-DVM
Description	Set a password used when communicating with a station, such as when applying settings to the station. Set a password that cannot easily be guessed. For IX-MV7-*, IXG-MK, and IX-SOFT, configure the property manager password used to login to the setting mode from the above and the station main unit (application) screen.
Settings	1-32 alphanumeric characters Cannot be set to "admin."

Note

- "Password(Administrator)" is displayed as "*****" in the Settings screen.

2.3 Time

Set the date and time for each station.

For IX-SOFT, set the time using the PC on which IX-SOFT is installed.

Move row

Up to 50 station number rows can be displayed at a time. Switch the screen as follows.

[Previous]: Display the previous 50 rows.

[Next]: Display the next 50 rows.

[Apply]: Enter the station number and click **[Apply]** to move the cursor to the row of the station number that was entered.

["Manual Date / Time Setup \(→page 102\)"](#)

Building Number	Unit Number	Station Name	Station Information	Time	Time Zone	Daylight Saving Time	Select time zone	Automatic Daylight Saving Time
01	001	Entrance Station1	(GMT-08:00) Pacific Standard Time (US), Tijuana			Disable		

2.3.1 Time Zone

■ Select time zone

Compatible type	<input checked="" type="checkbox"/> IXG-2C7(-*) <input checked="" type="checkbox"/> IXG-MK <input checked="" type="checkbox"/> IX-MV7-* <input checked="" type="checkbox"/> IXG-DM7(-*) <input checked="" type="checkbox"/> IX-DA, IX-DB <input checked="" type="checkbox"/> IX-BA, IX-BB <input checked="" type="checkbox"/> IX-DV, IX-DVF(-*) <input checked="" type="checkbox"/> IX-SSA(-*) <input checked="" type="checkbox"/> IX-EA, IX-EAU <input type="checkbox"/> IX-FA <input checked="" type="checkbox"/> IXGW-LC <input checked="" type="checkbox"/> IXGW-(T)GW <input type="checkbox"/> Intercom App <input checked="" type="checkbox"/> IX-SS-2G <input checked="" type="checkbox"/> IX-RS-* <input type="checkbox"/> IX-SOFT <input checked="" type="checkbox"/> IXW-MA <input type="checkbox"/> IX-SPMIC <input type="checkbox"/> VoIP Phone <input checked="" type="checkbox"/> IX-DVM
Description	Set the time zone.
Settings	Select from list

2.3.2 Daylight Saving Time

■ Automatic Daylight Saving Time

Compatible type	<input checked="" type="checkbox"/> IXG-2C7(-*) <input checked="" type="checkbox"/> IXG-MK <input checked="" type="checkbox"/> IX-MV7-* <input checked="" type="checkbox"/> IXG-DM7(-*) <input checked="" type="checkbox"/> IX-DA, IX-DB <input checked="" type="checkbox"/> IX-BA, IX-BB <input checked="" type="checkbox"/> IX-DV, IX-DVF(-*) <input checked="" type="checkbox"/> IX-SSA(-*) <input checked="" type="checkbox"/> IX-EA, IX-EAU <input type="checkbox"/> IX-FA <input checked="" type="checkbox"/> IXGW-LC <input checked="" type="checkbox"/> IXGW-(T)GW <input type="checkbox"/> Intercom App <input checked="" type="checkbox"/> IX-SS-2G <input checked="" type="checkbox"/> IX-RS-* <input type="checkbox"/> IX-SOFT <input checked="" type="checkbox"/> IXW-MA <input type="checkbox"/> IX-SPMIC <input type="checkbox"/> VoIP Phone <input checked="" type="checkbox"/> IX-DVM
Description	Use this to adjust the daylight saving time automatically to match the region selected in "Select time zone."
Settings	<ul style="list-style-type: none"> • Enable • Disable

2.3.3 Manual Date / Time Setup

Configure the date and time for each station. Be sure to set this, as the time is used for the incoming call history, outgoing call history, and the system log.

For IX-SOFT, set the time using the PC on which IX-SOFT is installed.

! Important

- The time cannot be set unless "Association Settings" has been performed in Administrator mode and the PC is connected to the same network as the station.

Click **[Manual Date / Time Setup]**. The "Manual Date / Time Setup" screen will be shown.

How to configure the date and time

1. Enter (select) "Year," "Month," "Day," "Hour," "Minute," and "Second."
 - Click **[Sync with PC]** to synchronize the time with the PC.
2. Click **[Apply]**.
 - If "Association Settings" have not been configured, the following screen will be shown. Click **[OK]** and perform "Association Settings" in Administrator mode.

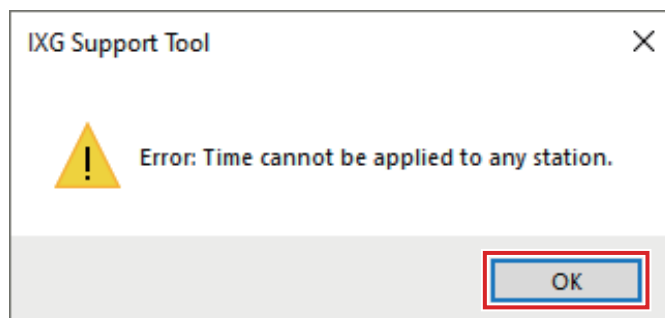

- If the PC cannot communicate with the system, the following screen will be shown. Click **[OK]**, and then make sure the PC can communicate with the system.

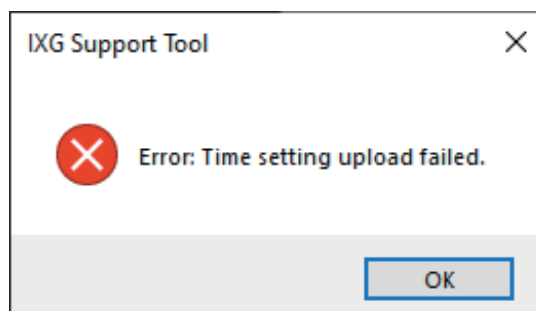

3. Click **[OK]**.

3. System Information (Move-in Settings)

3.1 Station List

Compatible type	<input checked="" type="checkbox"/> IXG-2C7(-*) <input checked="" type="checkbox"/> IXG-MK <input checked="" type="checkbox"/> IX-MV7-* <input checked="" type="checkbox"/> IXG-DM7(-*) <input type="checkbox"/> IX-DA, IX-DB <input type="checkbox"/> IX-BA, IX-BB <input type="checkbox"/> IX-DV, IX-DVF(-*) <input type="checkbox"/> IX-SSA(-*) <input type="checkbox"/> IX-EA, IX-EAU <input type="checkbox"/> IX-FA <input type="checkbox"/> IXGW-LC <input type="checkbox"/> IXGW-(T)GW <input checked="" type="checkbox"/> Intercom App <input type="checkbox"/> IX-SS-2G <input type="checkbox"/> IX-RS-* <input checked="" type="checkbox"/> IX-SOFT <input type="checkbox"/> IXW-MA <input type="checkbox"/> IX-SPMIC <input type="checkbox"/> VoIP Phone <input type="checkbox"/> IX-DVM
-----------------	--

Configure the station list for IX-MV7-*, IX-SOFT, IXG-MK, IXG-2C7(-*), IXG-DM7(-*), or Intercom App.

Up to 500 stations can be registered on IXG-2C7(-*) or the Intercom App.

The number of stations which can be registered on IX-MV7-* or IX-SOFT is the number of stations registered in [“Station List \(→page 104\)”](#) plus the number of units registered in [“Mobile App and Phone List \(→page 107\)”](#) for a total maximum of 9,998.

Important

- Calling, paging, monitoring (IXG-DM7(-*) and Door Stations only), line supervision, and device checking (IX Station only) can be performed by IX-MV7-* and IX-SOFT for stations registered in the Station List.
- Calling, paging, and monitoring (IXG-DM7(-*) and Door Stations only) can be performed by IXG-MK for stations registered in the Station List.
- Calling (except IXG-DM7(-*) and Door Stations) and monitoring (IXG-DM7(-*) and Door Stations only) can be performed by IXG-2C7(-*) for stations registered in the Station List.
- Calling can be performed by IXG-DM7(-*) for stations registered in the Station List.
- Monitoring can be performed by Intercom App for stations registered in the Station List.
- Monitoring can be performed for Network Cameras.

Move row

Up to 50 station number rows can be displayed at a time. Switch the screen as follows.

[Previous]: Display the previous 50 rows.

[Next]: Display the next 50 rows.

[Apply]: Enter the station number and click **[Apply]** to move the cursor to the row of the station number that was entered.

Move column

Up to 50 station number columns can be displayed at a time. Switch the screen as follows.

[Previous]: Display the previous 50 columns.

[Next]: Display the next 50 columns.

[Apply]: Enter the station number and click **[Apply]** to move the cursor to the column of the station number that was entered.

The screenshot shows the 'System Settings' interface. At the top, there are two navigation panels: 'Row' and 'Column'. Each panel has 'Previous', 'Next', and 'Apply' buttons, and a text input field for 'Enter Station Number'. Below these is a table with the following structure:

Building Number	Unit Number	Station Name	01 / 001 / 010010 Entrance Station1 / IXG-DM7(-*)		01 / 001 / 010011 Entrance Station2 / IXG-DM7(-*)		01 / 001 / 012030 Master Station1 / IX-MV7-*	
			Select	Network Camera	Select	Network Camera	Select	Network Camera
01	001	Entrance Station1		Network Camera Selection		Network Camera Selection		Network Camera Selection
01	001	Entrance Station2		Network Camera Selection		Network Camera Selection		Network Camera Selection
01	0001	Master Station1	✓	Network Camera Selection		Network Camera Selection		Network Camera Selection
01	101	Tenant Station1		001 Network Camera Selection		Network Camera Selection		Network Camera Selection
01	101	Intercom App1	✓	Network Camera Selection	Display 1 Only	Network Camera Selection	Display 1 Only	Network Camera Selection
01	101	Intercom App2	✓	Network Camera Selection	Display 1 Only	Network Camera Selection	Display 1 Only	Network Camera Selection
01	102	Tenant Station1	✓	001 Network Camera Selection		Network Camera Selection		Network Camera Selection
01	102	Intercom App1	✓	Network Camera Selection	Display 1 Only	Network Camera Selection	Display 1 Only	Network Camera Selection
01	103	Tenant Station1	✓	Network Camera Selection		Network Camera Selection		Network Camera Selection
01	103	Intercom App1	✓	Network Camera Selection	Display 1 Only	Network Camera Selection	Display 1 Only	Network Camera Selection
01	104	Tenant Station1	✓	Network Camera Selection		Network Camera Selection		Network Camera Selection
01	104	Intercom App1	✓	Network Camera Selection	Display 1 Only	Network Camera Selection	Display 1 Only	Network Camera Selection
01	106	Intercom App1	✓	Network Camera Selection	Display 1 Only	Network Camera Selection	Display 1 Only	Network Camera Selection
01	106	Intercom App1	✓	Network Camera Selection	Display 1 Only	Network Camera Selection	Display 1 Only	Network Camera Selection
01	108	Tenant Station1	✓	Network Camera Selection		Network Camera Selection		Network Camera Selection

List of IX-MV7-*, IX-SOFT, IXG-MK, IXG-2C7(-*), IXG-DM7(-*), Intercom App in setting data

If no network camera is registered in "Network Camera List (→page 109)", this will not be shown.

List of stations that can be registered to the station list

! Important

- Stations in which "IP Address" has not been configured in Administrator mode cannot be registered to the station list.
- To access stations registered to the station list by hostname, configure "IP Address" - "Hostname" and "DNS Server" in Administrator mode.

How to create a Station List

1. Search for a station to configure the station list from the "List of IX-MV7-*, IX-SOFT, IXG-MK, IXG-2C7(-*), IXG-DM7(-*), Intercom App in setting data."
2. Search for the station to register from the "List of stations that can be registered to the station list."

3. Click the cells ("Select," "Network Camera," and "Door Release Button") that correspond to Steps 1 and 2.

- Select: Any stations with "✓" selected will be registered to the station list.
- Network Camera (IX-MV7-*, IXG-MK, IXG-2C7(-*), IX-SOFT only): Click **[Network Camera Selection]**, and then select the network camera to associate. Network cameras configured in ["Network Camera List \(→page 109\)"](#) may be selected. The number of the selected network camera is displayed.

If a network camera is associated with a station, the video from the network camera will be displayed when placing a call, during a communication, or when monitoring.

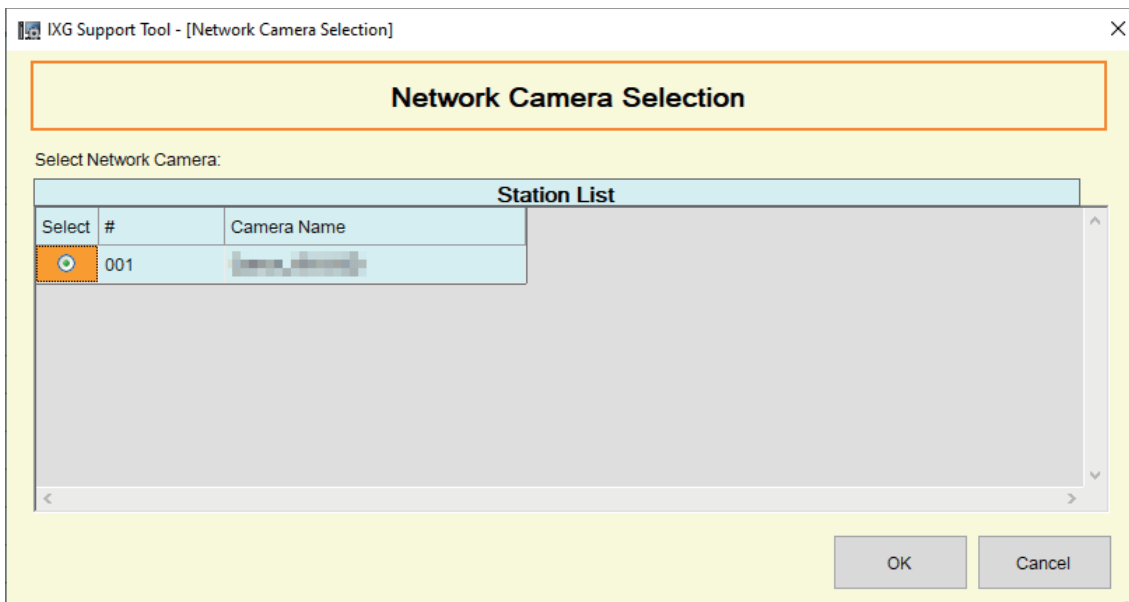

- Door Release Button (Intercom App only): Set whether to display the Door Release button on the station screen in order to release the door.
 - Disable: Do not display the Door Release button on the station screen.
 - Display 1 Only: Display only Door Release button 1 on the station screen.
 - Display 1 and 2: Display Door Release button 1 and Door Release button 2 on the station screen.

4. After configuration is complete, click **[Update]**.

5. Click **[OK]**.

3.2 Mobile App and Phone List

Compatible type	<input checked="" type="checkbox"/> IXG-2C7(-*) <input checked="" type="checkbox"/> IXG-MK <input checked="" type="checkbox"/> IX-MV7-* <input checked="" type="checkbox"/> IXG-DM7(-*) <input type="checkbox"/> IX-DA, IX-DB <input type="checkbox"/> IX-BA, IX-BB <input type="checkbox"/> IX-DV, IX-DVF(-*) <input type="checkbox"/> IX-SSA(-*) <input type="checkbox"/> IX-EA, IX-EAU <input type="checkbox"/> IX-FA <input type="checkbox"/> IXGW-LC <input type="checkbox"/> IXGW-(T)GW <input checked="" type="checkbox"/> Intercom App <input type="checkbox"/> IX-SS-2G <input type="checkbox"/> IX-RS-* <input checked="" type="checkbox"/> IX-SOFT <input type="checkbox"/> IXW-MA <input type="checkbox"/> IX-SPMIC <input type="checkbox"/> VoIP Phone <input type="checkbox"/> IX-DVM
-----------------	--

Register a unit containing the Intercom App or phone to call, to the Mobile Apps and Phone list. Any Intercom Apps or phones contained in the registered unit may be called.

The number of stations which can be registered on IX-MV7-* or IX-SOFT is the number of stations registered in ["Station List \(→page 104\)"](#) plus the number of units registered in ["Mobile App and Phone List \(→page 107\)"](#) for a total maximum of 9,998.

Move row

Up to 50 station number rows can be displayed at a time. Switch the screen as follows.

[Previous]: Display the previous 50 rows.

[Next]: Display the next 50 rows.

[Apply]: Enter the station number and click **[Apply]** to move the cursor to the row of the station number that was entered.

Move column

Up to 50 station number columns can be displayed at a time. Switch the screen as follows.

[Previous]: Display the previous 50 columns.

[Next]: Display the next 50 columns.

[Building Number]: Select a building.

[Apply]: Select a building number, enter a Unit Number, and then click **[Apply]** to move the cursor to the column of the unit number that was entered.

List of IXG-MK, IX-MV7-*, IXG-2C7(-*), IXG-DM7(-*), IX-SOFT, Intercom App in setting data

List of units that can be registered to the Mobile App and Phone List list

How to create a Mobile App and Phone List

1. Search for a station to configure the Mobile Apps and Phone list from the "List of IXG-MK, IX-MV7-*, IXG-2C7(-*), IXG-DM7(-*), IX-SOFT, Intercom App in setting data."
2. Search for the unit to register from the "List of units that can be registered to the Mobile Apps and Phone list."
3. Click the cell that corresponds to Steps 1 and 2.
 - Select: Any units with "✓" selected will be registered to the Mobile Apps and Phone list.

4. After configuration is complete, click **[Update]**.
5. Click **[OK]**.

3.3 Network Camera List

IX-MV7-*, IXG-MK, IXG-2C7(-*), and IX-SOFT support ONVIF Profile S.

Video and audio captured by a 3rd party network camera and microphone can be monitored on the IX-MV7-*, IXG-MK, IXG-2C7(-*), or IX-SOFT screen.

Register the network camera in the network camera list. Up to 500 network cameras can be registered.

Configure "Network Camera Integration" in Administrator mode to configure event notification-related settings for the network camera.

Resolution of network cameras capable of displaying video	Resolution of network cameras capable of recording video
<ul style="list-style-type: none"> IX-MV7-*, IXG-MK: SXGA or lower IXG-2C7(-*): HD or lower (However, set to 5 fps or lower if larger than WVGA.) IX-SOFT: Full HD or lower 	<ul style="list-style-type: none"> IX-MV7-*, IXG-MK: QVGA, VGA, WVGA, HD, SXVGA IXG-2C7(-*): QVGA, VGA, WVGA, HD IX-SOFT: Resolution unspecified

Move row

Up to 50 station number rows can be displayed at a time. Switch the screen as follows.
[Previous]: Display the previous 50 rows.
[Next]: Display the next 50 rows.
[Apply]: Enter the station number and click **[Apply]** to move the cursor to the row of the station number that was entered.

Move column

Up to 50 station number columns can be displayed at a time. Switch the screen as follows.
[Previous]: Display the previous 50 columns.
[Next]: Display the next 50 columns.
[Apply]: Enter the station number and click **[Apply]** to move the cursor to the column of the station number that was entered.

List of network cameras that can be registered to the network camera list

["Network Camera Registry \(→page 110\)"](#)

The screenshot shows the 'Network Camera List' interface. At the top, there are two navigation sections: 'Row' and 'Column'. The 'Row' section has 'Previous', 'Next', and 'Apply' buttons, along with an input field for 'Enter Station Number'. The 'Column' section has similar buttons and an input field for 'Enter Network Camera Number'. To the right, there is a '[Related Settings]' section with a button for 'Open Network Camera Registry'. Below these is a table with columns for 'Building Number', 'Unit Number', and 'Station Name'. A 'System Information' table is overlaid on the right, showing settings for '001' with columns for 'Select', 'PTZ Operation', and 'Audio Monitoring'. A red box highlights a row in the station list with a red arrow pointing to it, and another red box highlights a row in the 'System Information' table with a red arrow pointing to it.

List of IX-MV7-*, IXG-MK, IXG-2C7(-*), IX-SOFT in setting data

If no network camera is registered, this will not be shown.

How to create a Network Camera List

1. Register the network camera in ["Network Camera Registry \(→page 110\)"](#).
2. Search for a station to configure the network camera list from the "List of IX-MV7-*, IXG-MK, IXG-2C7(-*), IX-SOFT in setting data."
3. Search for a network camera to register from the "List of network cameras that can be registered to the to the network camera list."
4. Click the cells ("Select," "PTZ Operation," and "Audio Monitoring") that correspond to Step 2 and Step 3.
 - Select: Any network cameras with "✓" selected will be registered to the network camera list. All items are "blank (unregistered)" by default.
 - PTZ Operation (except IXG-2C7(-*)): Configure whether to allow network camera PTZ operation from the station. All items are set to "Enable" by default.
 - Audio Monitoring: Configure whether to allow monitoring of network camera audio from the station. All items are set to "Enable" by default.
5. After configuration is complete, click **[Update]**.
6. Click **[OK]**.

3.3.1 Network Camera Registry

Click **[Open Network Camera Registry]**. The following screen is displayed.

["How to register a new network camera \(→page 112\)"](#)

Select the network camera(s) to be deleted (multiple selections allowed), and click to delete.

[Related Settings]

Add Camera Delete

Station Information			Network Settings			Function Settings	
Select	#	Camera Name	Hostname	IP Address (IPv4)	IP Address (IPv6)	ID	Password
<input type="checkbox"/>	001			192.168.1.100			*****

If no network camera is registered, this will not be shown.

! Important

- In order to configure network camera registration at least one IX-MV7-*, IXG-MK, IXG-2C7(-*), or IX-SOFT must be associated in "Association Settings" in Administrator mode, and the PC must be able to communicate with the system. (This is because, when registering a network camera, the network camera is searched through IX-MV7-*, IXG-MK, or IXG-2C7(-*.)
- Even if the network camera unit settings (resolution, etc.) are changed after uploading the settings to stations (IXG-2C7(-*), IX-MV7-*, IXG-MK, or IX-SOFT) which display network camera video with the IXG Support Tool, the settings are not updated on the stations. Network camera information on the station must first be cleared. Follow the steps below.
 1. Delete the reconfigured network camera in the "Network Camera List."
 2. With the target network camera in an unregistered state, upload the settings to the station. (The network camera information will disappear on the station side)
 3. Register the target network camera from the "Network Camera List" once more and upload the settings to the station.

💡 Note

- When searching on the station, the numbers will be displayed in the order they were registered.

■ Camera Name ◆

Description	Set the Network Camera Name.
Settings	1-24 alphanumeric characters

■ Hostname

Description	Set the hostname. When setting the hostname, configure "DNS server" in Administrator mode.
Settings	1-64 alphanumeric characters

■ IP Address (IPv4) ◆

Description	Set the IPv4 address for Network camera.
Settings	1.0.0.1-223.255.255.254

■ IP Address (IPv6) ◆

Description	Set the IPv6 address for Network camera.
Settings	::FF:0-FE:FF:FFFF:FFFF:FFFF:FFFF:FFFF:FFFF

■ ID ◆

Description	Enter ID of the network camera.
Settings	1-32 alphanumeric characters

■ Password ◆

Description	Enter Password of the network camera.
Settings	1-32 alphanumeric characters

💡 Note

- "Password" is displayed as "*****" in the Settings screen.

How to register a new network camera

Registration cannot be performed if the PC is not connected to the same network as the network camera.

Click **[Add Camera]** to search for a network camera. (Searching may take several minutes.)

When searching is complete, the "Network Camera Selection" screen is displayed, and the network cameras connected to the network are displayed in the "Network Camera Search List."

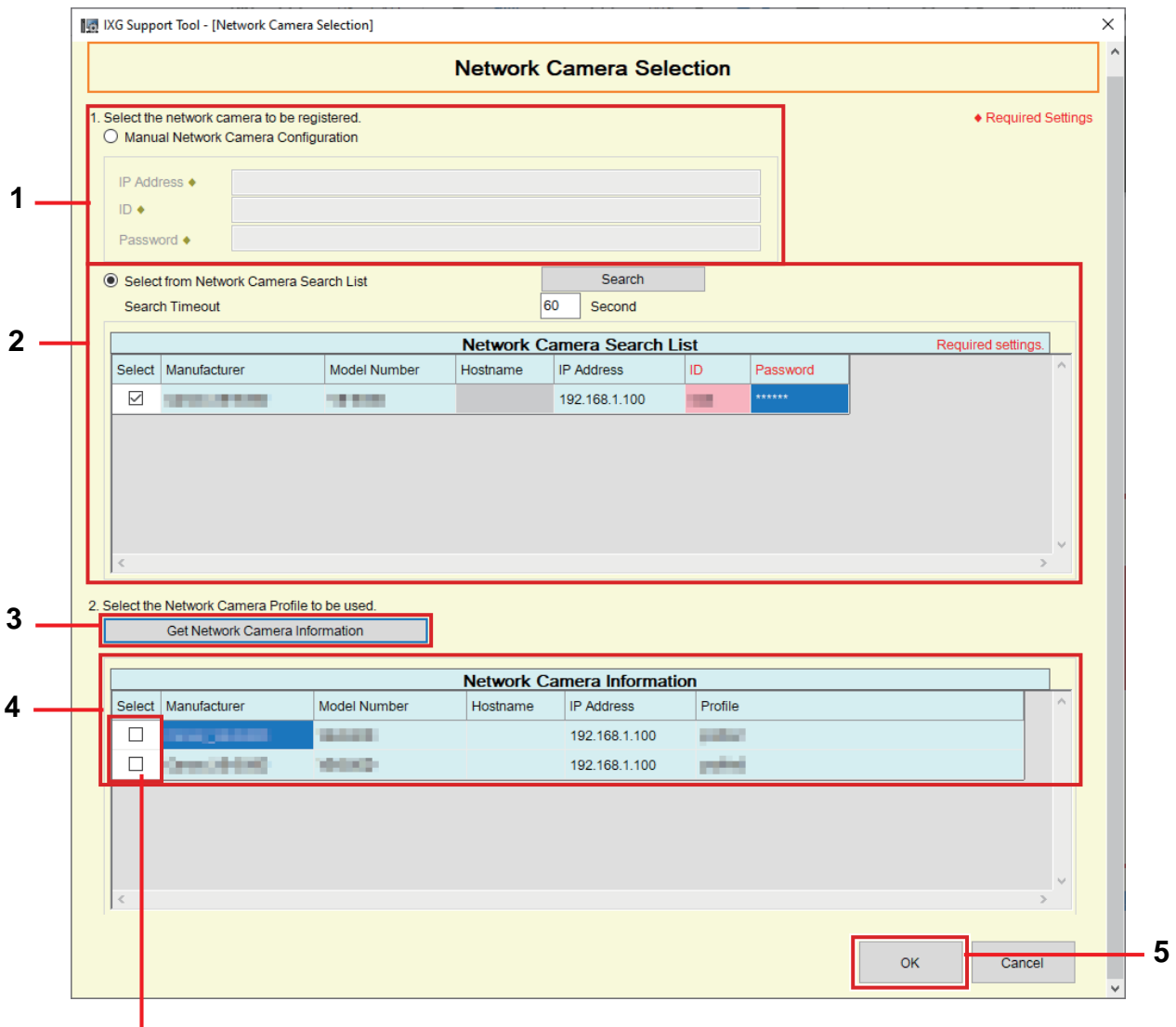

If the video profile cannot be obtained, nothing will be shown.

1. To register by specifying an IP address, select "Manual Network Camera Configuration," and then enter the "IP Address♦," "ID♦," and "Password♦" of the network camera.
2. To select from the Network Camera Search List, select "Select from Network Camera Search List." Select the network camera to register from the "Network Camera Search List" (multiple selections allowed), and then enter the "Hostname," "ID♦," and "Password♦." When entering the hostname, configure "DNS server" in Administrator mode. To search again, click **[Search]**. It is also possible change the search time.
3. Click **[Get Network Camera Information]**. (Obtaining the video profile may take several minutes.) When video profiles are successfully obtained, they will be shown in "Network Camera Information."
4. Choose the video profile to be registered from the list. (Multiple selections allowed.)

5. Click **[OK]** to register the network camera.

3.4 Group

Compatible type	<input type="checkbox"/> IXG-2C7(-*) <input type="checkbox"/> IXG-MK <input checked="" type="checkbox"/> IX-MV7-* <input type="checkbox"/> IXG-DM7(-*) <input type="checkbox"/> IX-DA, IX-DB <input type="checkbox"/> IX-BA, IX-BB <input type="checkbox"/> IX-DV, IX-DVF(-*) <input type="checkbox"/> IX-SSA(-*) <input type="checkbox"/> IX-EA, IX-EAU <input type="checkbox"/> IX-FA <input type="checkbox"/> IXGW-LC <input type="checkbox"/> IXGW-(T)GW <input type="checkbox"/> Intercom App <input type="checkbox"/> IX-SS-2G <input type="checkbox"/> IX-RS-* <input checked="" type="checkbox"/> IX-SOFT <input type="checkbox"/> IXW-MA <input type="checkbox"/> IX-SPMIC <input type="checkbox"/> VoIP Phone <input type="checkbox"/> IX-DVM
-----------------	--

Configure the group for groups calls, group pages, and contact input calls.

Up to 50 stations can be added per group (Intercom Apps and phones: 49 stations per group and a single unit containing the Intercom App or phone), and up to 99 groups can be configured.

Move row

Up to 50 station number rows can be displayed at a time. Switch the screen as follows.

[Previous]: Display the previous 50 rows.

[Next]: Display the next 50 rows.

[Apply]: Enter the station number and click **[Apply]** to move the cursor to the row of the station number that was entered.

Move column

Up to 50 station number columns can be displayed at a time. Switch the screen as follows.

[Previous]: Display the previous 50 columns.

[Next]: Display the next 50 columns.

[Apply]: Enter the station number and click **[Apply]** to move the cursor to the column of the station number that was entered.

Row Previous Next

Enter Station Number Apply

Column Previous Next

Enter Station Number Apply

[Display settings]

Group Number

01

U = Unicast, M = Multicast
If designating "M", multicast IP addresses must be configured for the station(s).

Building Number	Unit Number	Station Name	System Information				System Information				
			Group				Group				
			Number	Name	Type	Total	Building Number / Unit Number / Station Number / Station Name / Station Type				
			01						01 / 001 / 010010 / Entrance Station1 / IXG-DM7(-*)	01 / 001 / 010011 / Entrance Station2 / IXG-DM7(-*)	01 / 0001 / 012030 / Master Station
01	0001	Master Station1			Audio Protocol	0					
					Video Protocol	0					
01	202	Master Station1			Audio Protocol	0					
					Video Protocol	0					
02	0002	Master Station1			Audio Protocol	0					
					Video Protocol	0					
03	0003	Master Station1			Audio Protocol	0					
					Video Protocol	0					
04	0004	Master Station1			Audio Protocol	0					
					Video Protocol	0					
05	0005	Master Station1			Audio Protocol	0					
					Video Protocol	0					

! Important

- Always set "[Language \(→page 91\)](#)" before setting "Group."
- Enter using the language set in "[Language \(→page 91\)](#)". However, if the language (configured on the station main unit) displayed on the screen for IX-MV7-* or IX-SOFT is different from the language set with "[Language \(→page 91\)](#)", text displayed on the station screen may appear incorrectly. To avoid this, enter information using alphabetical characters only.
- All Page, Group Page, Building Page, Message Page, and External Input Page cannot be used with VoIP phones.
- Stations in which "IP Address" has not been configured in Administrator mode or that have not been registered in "[Station List \(→page 104\)](#)", and units (Intercom Apps and phones) not registered in "[Mobile App and Phone List \(→page 107\)](#)" cannot be registered to a group.
- Group calls and contact input calls cannot be made to IX-DA, IX-DB, IX-BA, IX-BB.
- When making a group call, it may take some time for video to display on some stations.
- Results when searching by station will be listed in order of group number.

3.4.1 Configuring a Group

Configure the group to register in each station.

1

2

3

4

5

6

List of IX-MV7-* and IX-SOFT in setting data

Group Information

List of stations that can be registered to group

1. Select the group to configure from "Group Number." The Settings screen for the selected group will be shown on the screen.
2. Enter the following information in "Group Information."
 - Number: 01-99
Group numbers must be unique.
 - Name: 1-24 alphanumeric characters
3. Search for the station to configure from the "List of IX-MV7-* and IX-SOFT in setting data."
4. Search for the station to be registered from the "List of stations that can be registered to group."
5. Click the cells that correspond to Steps 3 and 4. Select an audio protocol and video protocol setting value for each, and register to a group.
 - The number of registered stations is displayed in the Audio Protocol "Total."
 - The number of stations with video protocol set to "U" is displayed in the video protocol "Total."

Audio Protocol

 - Blank: Select to not register to a group.
 - U: Register to group. Audio will be transmitted in unicast during group paging.
 - M: Register to group. Audio will be transmitted in multicast during group paging.

Video protocol (only when IX-MV7-*, IXG-MK, IXG-2C7(-*), or IX-SOFT is the station to register)

 - Blank: Video will be transmitted as multicast.
 - U: Video will be transmitted in unicast during group calls. Unicast can reach up to 20 stations.
 - M: Video will be transmitted in multicast during group calls.

The video protocol pull-down menu is shown when the audio protocol setting is selected.
All items are blank by default.

6. To register an Intercom App to a group, click "Mobile Apps and Phone" - "[Select]".
7. Select the unit containing the Intercom App or phone station to register to the group.
8. Click [OK].
 - Click [Cancel] to quit without registering an Intercom App or phone.
9. After configuration is complete, click [Update].
10. Click [OK].

 **Important**

- If "M" is selected, or if "Blank" is selected for the video protocol setting, be sure to configure "Multicast Address" in Administrator mode.

 **Note**

- When making a group call, the audio protocol will be set to "U" and cannot be changed.

3.5 Custom Sound Registry

Register the audio files to be used for ringback tones, etc.
The numbers of audio files that can be registered to each station are as follows.

Station Type	Information that can be saved to the station
IXG-DM7(-*)	Max. 100 files (total length of within 200 seconds and 8 Mbytes)
IX-DV, IX-DVF(-*)	Max. 100 files (total length of within 200 seconds and 8 Mbytes)
IX-SSA(-*)	Max. 100 files (total length of within 200 seconds and 8 Mbytes)
IX-MV7-*	Max. 100 files (with 200 seconds and 8 Mbytes per file)
IX-EA	Max. 100 files (total length of within 200 seconds and 8 Mbytes)
IX-DA, IX-DB	Max. 100 files (total length of within 200 seconds and 8 Mbytes)
IX-BA, IX-BB	Max. 100 files (total length of within 200 seconds and 8 Mbytes)
IXG-MK	Max. 100 files (within 200 seconds and 8 Mbytes per file)
IX-RS-*	Max. 100 files (total length of within 200 seconds and 8 Mbytes)
IX-SS-2G	Max. 100 files (total length of within 200 seconds and 8 Mbytes)
IX-SOFT	Max. 100 files (within 200 seconds and 8 Mbytes per file)
IX-DVM	Max. 100 files (total length of within 200 seconds and 8 Mbytes)

Sound file format

- File Type: .wav
- Sample Size: 16 bits
- Sample rate: 8 kHz
- Channel: 1 (monaural)
- File name: Within 41 characters (excluding extension)
- For IX-MV7-* or IXG-MK, search for audio files used for message paging by file name by entering either a letter or number as the first character.



Note

- If using a file for a ringback tone, ringtone, or network camera event tone, add a period of silence in the .wav file if the tone is to be intermittent.

Move row

Up to 50 station number rows can be displayed at a time. Switch the screen as follows.

[Previous]: Display the previous 50 rows.

[Next]: Display the next 50 rows.

[Apply]: Enter the station number and click **[Apply]** to move the cursor to the row of the station number that was entered.

["How to register multiple custom sounds at once \(→page 119\)"](#)

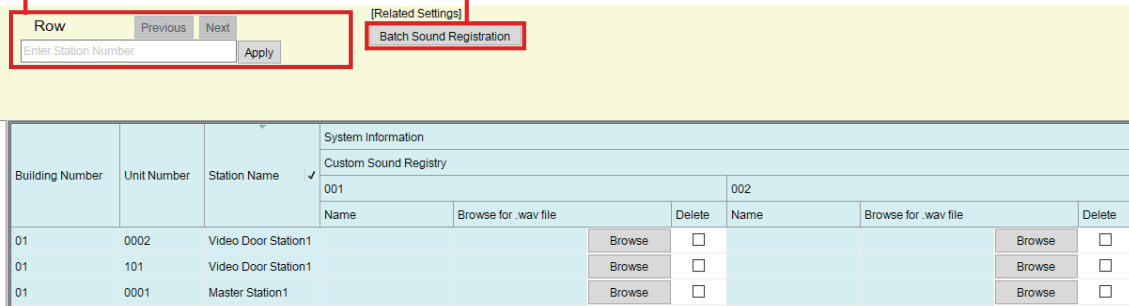

How to register custom sound

1. Click **[Browse]** on the row of the station with which to register the audio file.
2. Select the audio file to register and click **[Open]**.
3. Information on the selected audio file will be shown.
 - Name: The file name of the audio file is shown. Up to 127 bytes of alphanumeric characters will be displayed. The name will be shown as the setting value when configuring the ringback tone etc. If the file name of the audio file exceeds the character limit above, it cannot be registered.
 - Browse for .wav file: The audio file reference destination is shown.
4. After configuration is complete, click **[Update]**.
5. Click **[OK]**.

How to delete a custom sound

1. Check the **[Delete]** box of the audio file to delete.
2. Click **[Update]**.
3. Click **[OK]**.

 **Note**

• "Name" is uploaded in "Sounds" in ["Upload Settings \(→page 71\)"](#), and can be deleted from the Settings screen by deleting the audio file from the station.

How to register multiple custom sounds at once

Audio files can be registered to multiple stations at once.

Click **[Batch Sound Registration]**. The following screen will be shown.

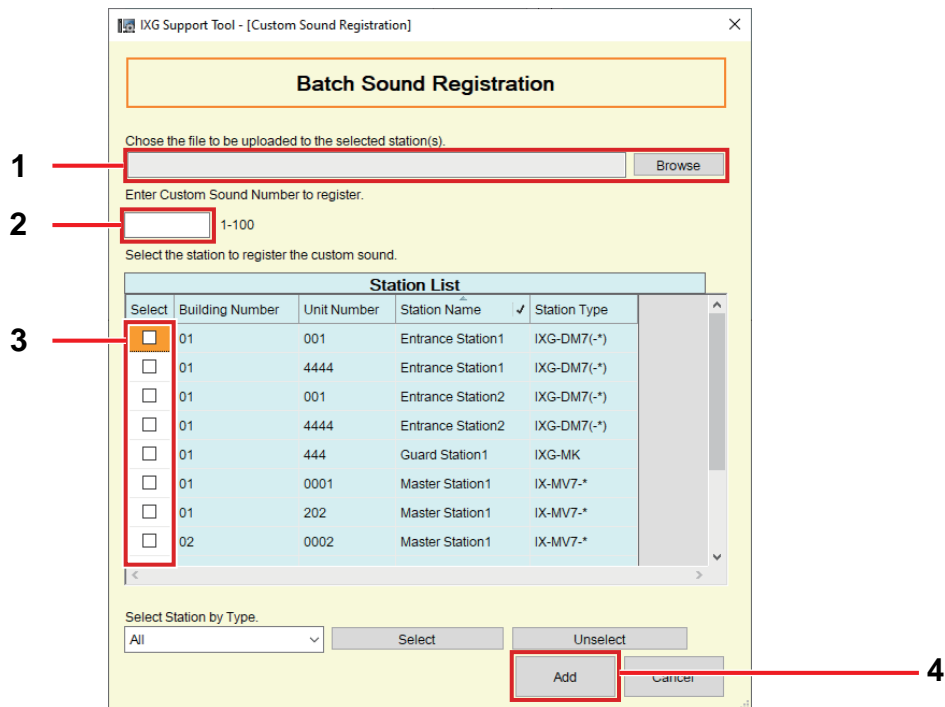

1. Click **[Browse]**, select the audio file to register, and then click **[Open]**.
2. Enter the number of the custom sound to register the audio file.
 - Custom Sound No.: 1-100
3. Select the station for which to register the audio file "Station List." (Multiple selections allowed.)
 - To select or unselect stations in a batch, choose the station type and click **[Select]** or **[Unselect]**.
4. Click **[Add]**.
 - Click **[Cancel]** to quit without registering multiple files.
5. Information on the added audio file will be shown.
 - Name: Displays the file name of the audio file.
The name will be shown when configuring the ringback tone, etc.
 - If the file name of the audio file exceeds the character limit above, it cannot be registered.
 - Browse for .wav file: The audio file reference destination is shown.
6. After configuration is complete, click **[Update]**.
7. Click **[OK]**.

4. Call Settings (Move-in Settings)

4.1 Called Stations (Door/Sub Stations)

Compatible type	<input type="checkbox"/> IXG-2C7(-*) <input type="checkbox"/> IXG-MK <input type="checkbox"/> IX-MV7-* <input type="checkbox"/> IXG-DM7(-*) <input checked="" type="checkbox"/> IX-DA, IX-DB <input checked="" type="checkbox"/> IX-BA, IX-BB <input checked="" type="checkbox"/> IX-DV, IX-DVF(-*) <input checked="" type="checkbox"/> IX-SSA(-*) <input checked="" type="checkbox"/> IX-EA, IX-EAU <input type="checkbox"/> IX-FA <input type="checkbox"/> IXGW-LC <input type="checkbox"/> IXGW-(T)GW <input type="checkbox"/> Intercom App <input checked="" type="checkbox"/> IX-SS-2G <input checked="" type="checkbox"/> IX-RS-* <input type="checkbox"/> IX-SOFT <input type="checkbox"/> IXW-MA <input type="checkbox"/> IX-SPMIC <input type="checkbox"/> VoIP Phone <input checked="" type="checkbox"/> IX-DVM
-----------------	--

Configure the group to call when a call is made using the call button or via contact input.

- Stations except IX-DA, IX-DB, IX-BA, IX-BB: Up to 20 stations per group (Mobile Apps and Phones: 19 stations per group and a single unit containing the Intercom App or phone), and up to 10 groups can be configured.
- IX-DA, IX-DB, IX-BA, IX-BB: Up to 20 stations can be added per group (Mobile Apps and phones: 19 stations per group and a single unit containing the Intercom App or phone). A single group for Call Button use and up to 9 groups for Contact Input Call use can be configured.

! Important

- To release the electrical lock for IX-RS-* when in communication with IXG-DM7(-*), IX-DA, IX-DB, IX-BA, IX-BB, register IXG-DM7(-*), IX-DA, IX-DB, IX-BA, IX-BB in the group. However, outgoing calls cannot be placed for IXG-DM7(-*), IX-DA, IX-DB, IX-BA, IX-BB.

Move row

Up to 50 station number rows can be displayed at a time. Switch the screen as follows.
[Previous]: Display the previous 50 rows.
[Next]: Display the next 50 rows.
[Apply]: Enter the station number and click **[Apply]** to move the cursor to the row of the station number that was entered.

Move column

Up to 50 station number columns can be displayed at a time. Switch the screen as follows.
[Previous]: Display the previous 50 columns.
[Next]: Display the next 50 columns.
[Apply]: Enter the station number and click **[Apply]** to move the cursor to the column of the station number that was entered.

Move to Related Settings

Moves to the selected item within the same Settings screen.

1

2

3

4

5

List of Door Stations (with camera), Handset Sub Stations, and Audio Sub Stations in setting data

List of stations that can be registered to group

Building Number	Unit Number	Station Name	Total
01	0002	Video Door Station1	1
01	101	Video Door Station1	1
01	203	Video Door Station1	0
01	207	Handset Sub Station1	1
01	208	Handset Sub Station1	0
01	209	Handset Sub Station1	0
01	210	Handset Sub Station1	0

 **Important**

- A station cannot be registered as a destination unless "IP Address" has been configured for the station in Administrator mode.

How to configure destinations (Door/Sub Stations)

1. Select the group to configure from "Display settings."
 - The Settings screen for the selected group will be displayed.
 - Use the following groups when configuring the IX-DA, IX-DB and IX-BA, IX-BB call destination.
 - Groups used to place a call by operating the call button: "Group 10"
 - Groups used to place a call by Option Input: "Group 01 - 09"
2. Search for the station to configure from the "List of Door Stations (with cameras), Handset Sub Stations, Audio Sub Stations in setting data."
3. Search for the station to be registered from the "list of stations that can be registered to group."
4. Click the cells that correspond to Steps 2 and 3. Select the setting value and register to the group.
 - The number of registered stations will be displayed in "Total."
 - Blank: Select to not register to a group.
 - U: Register to group. Video and audio will be transmitted in unicast when making an outgoing call.
 - M: Register to group. Video transmitted in multicast and audio will be transmitted in unicast when making an outgoing call.
 - This can only be configured if the station to configure is IX-DV, IX-DVF(-*), IX-DA, IX-DB, IX-EA, or IX-DVM, and the call destination is IX-MV7-*, IXG-MK, IX-SOFT, or IXG-2C7(-*).
5. To register an Intercom App or phone to a group, click "Mobile Apps and Phone" - "Select."

6. Select the unit containing the Intercom App or phone to register to the group.

Select	Building Number	Unit Number	Unit Name
<input type="checkbox"/>	01	101	Residential101
<input type="checkbox"/>	01	102	Residential102
<input type="checkbox"/>	01	103	Residential103
<input type="checkbox"/>	01	104	Residential104
<input type="checkbox"/>	01	105	Residential105
<input type="checkbox"/>	01	201	Guard201

7. Click **[OK]**.
 - Click **[Cancel]** to quit without registering an Intercom App or phone.

Important

- If "M" is selected, be sure to configure "Multicast Address" in Administrator mode.

4.2 Call Origination

Configure outgoing call settings.

Select the outgoing call method to configure in **[Display settings]**.

Move row

Up to 50 station number rows can be displayed at a time. Switch the screen as follows.

[Previous]: Display the previous 50 rows.

[Next]: Display the next 50 rows.

[Apply]: Enter the station number and click **[Apply]** to move the cursor to the row of the station number that was entered.

Display settings

Displays settings for the selected outgoing call method. The outgoing call methods that can be configured vary by station.

[Call Button]: Displays settings related to outgoing calls made by operating the station main unit.

[Contact Input 1 to 6]: Displays settings related to outgoing calls when "Call" is selected for "Option Input" - "Function" in Administrator mode.

["Weekly Schedule \(→page 126\)"](#)

["Daily Schedule \(→page 129\)"](#)

Move to Related Settings

Moves to the selected item within the same Settings screen.

The screenshot shows the 'Call Origination' settings screen. At the top, there are navigation buttons: 'Row' (with 'Previous' and 'Next' sub-buttons), 'Apply', and 'Enter Station Number'. Below these are several tabs: '[Display settings]' (selected), '[Call Button]', '[Weekly Schedule]', '[Daily Schedule]', and '[Move to Related Settings]'. The main area contains a table with columns for Building Number, Unit Number, Station Name, Call Method, Ringback Tone, Call Timeout, Ringback Tone Count, Standard Mode Settings, Destination Dwell 1, and Destination Dwell 2. The table lists various station configurations and their associated call settings.

4.2.1 Call Origination Advanced Settings

■ Call Method

Compatible type	<input type="checkbox"/> IXG-2C7(-*) <input type="checkbox"/> IXG-MK <input type="checkbox"/> IX-MV7-* <input checked="" type="checkbox"/> IXG-DM7(-*) <input checked="" type="checkbox"/> IX-DA, IX-DB <input checked="" type="checkbox"/> IX-BA, IX-BB <input checked="" type="checkbox"/> IX-DV, IX-DVF(-*) <input checked="" type="checkbox"/> IX-SSA(-*) <input checked="" type="checkbox"/> IX-EA, IX-EAU <input type="checkbox"/> IX-FA <input type="checkbox"/> IXGW-LC <input type="checkbox"/> IXGW-(T)GW <input type="checkbox"/> Intercom App <input checked="" type="checkbox"/> IX-SS-2G <input checked="" type="checkbox"/> IX-RS-* <input type="checkbox"/> IX-SOFT <input type="checkbox"/> IXW-MA <input type="checkbox"/> IX-SPMIC <input type="checkbox"/> VoIP Phone <input checked="" type="checkbox"/> IX-DVM
Description	Select the Call Method to change call destinations automatically by time delay or schedule.
Settings	<ul style="list-style-type: none"> Standard Destination: Switching is not performed automatically. IXG-DM7(-*), IX-DA, IX-DB, IX-BA, IX-BB are set to "Standard Destination" and cannot be changed. Change Destination by Time Delay: Switching is performed on the timer configured in "Destination Dwell Time♦ (→page 125)". Switching destination groups are configured in "Destination Dwell 1-8 (→page 125)". Up to 8 groups can be configured. Change Destination by Schedule: Switching is performed on the schedule configured in "Weekly Schedule (→page 126)" and "Daily Schedule (→page 129)".

■ Ringback Tone

Compatible type	<input checked="" type="checkbox"/> IXG-2C7(-*) <input checked="" type="checkbox"/> IXG-MK <input checked="" type="checkbox"/> IX-MV7-* <input checked="" type="checkbox"/> IXG-DM7(-*) <input checked="" type="checkbox"/> IX-DA, IX-DB <input checked="" type="checkbox"/> IX-BA, IX-BB <input checked="" type="checkbox"/> IX-DV, IX-DVF(-*) <input checked="" type="checkbox"/> IX-SSA(-*) <input checked="" type="checkbox"/> IX-EA, IX-EAU <input type="checkbox"/> IX-FA <input type="checkbox"/> IXGW-LC <input type="checkbox"/> IXGW-(T)GW <input type="checkbox"/> Intercom App <input checked="" type="checkbox"/> IX-SS-2G <input checked="" type="checkbox"/> IX-RS-* <input checked="" type="checkbox"/> IX-SOFT <input type="checkbox"/> IXW-MA <input type="checkbox"/> IX-SPMIC <input type="checkbox"/> VoIP Phone <input checked="" type="checkbox"/> IX-DVM
Description	Select the sound to be played by the station when placing a call. For IX-MV7-*, IXG-2C7(-*), IXG-MK, and IX-SOFT, this will also sound when monitoring.
Settings	<ul style="list-style-type: none"> • None (except IX-DA, IX-DB, IX-BA, IX-BB) • Call Pattern 1 • Call Pattern 2 • Call Pattern 3 • Call Pattern 4 • Call Pattern 5 • Call Pattern 6 • Call Pattern 7 (IX-EA, IX-DVM only) • Tremolo Sound • Busy Response Tone (IX-DA, IX-DB, IX-BA, IX-BB: Busy Tone) • On Hold • Operation Sound (except IX-SOFT) • Error (IX-DA, IX-DB, IX-BA, IX-BB are Error Tone) • Pre Tone 1 (except IX-DA, IX-DB, IX-BA, IX-BB) • Pre Tone 2 (except IX-DA, IX-DB, IX-BA, IX-BB) • Pre Tone 3 (except IX-DA, IX-DB, IX-BA, IX-BB) • Communication End Pretone (except IX-DA, IX-DB, IX-BA, IX-BB) • Call Queue Notification (except IX-DA, IX-DB, IX-BA, IX-BB) • Waiting Reply Tone (except IX-DA, IX-DB, IX-BA, IX-BB) • Audio Guidance (IXG-DM7(-*) only) • Select a sound that is registered in "Custom Sound Registry (→page 117)". For IXG-MK, change the setting on the screen of the station. IXG-2C7(-*) is set to "Call Pattern 4" and cannot be changed.

■ Call Timeout◆

Compatible type	<input checked="" type="checkbox"/> IXG-2C7(-*) <input checked="" type="checkbox"/> IXG-MK <input checked="" type="checkbox"/> IX-MV7-* <input checked="" type="checkbox"/> IXG-DM7(-*) <input checked="" type="checkbox"/> IX-DA, IX-DB <input checked="" type="checkbox"/> IX-BA, IX-BB <input checked="" type="checkbox"/> IX-DV, IX-DVF(-*) <input checked="" type="checkbox"/> IX-SSA(-*) <input checked="" type="checkbox"/> IX-EA, IX-EAU <input type="checkbox"/> IX-FA <input type="checkbox"/> IXGW-LC <input type="checkbox"/> IXGW-(T)GW <input type="checkbox"/> Intercom App <input checked="" type="checkbox"/> IX-SS-2G <input checked="" type="checkbox"/> IX-RS-* <input checked="" type="checkbox"/> IX-SOFT <input type="checkbox"/> IXW-MA <input type="checkbox"/> IX-SPMIC <input type="checkbox"/> VoIP Phone <input checked="" type="checkbox"/> IX-DVM
Description	Configure the call timeout.
Settings	<ul style="list-style-type: none"> • Infinite: Continue outgoing call until the recipient answers. • 10-600 sec: Configure between 10 to 600 sec (by 1 sec). For IXG-MK, change the setting on the screen of the station.

■ Ringback Tone Count [time(s)]

Compatible type	<input checked="" type="checkbox"/> IXG-2C7(-*) <input checked="" type="checkbox"/> IXG-MK <input checked="" type="checkbox"/> IX-MV7-* <input checked="" type="checkbox"/> IXG-DM7(-*) <input checked="" type="checkbox"/> IX-DA, IX-DB <input checked="" type="checkbox"/> IX-BA, IX-BB <input checked="" type="checkbox"/> IX-DV, IX-DVF(-*) <input checked="" type="checkbox"/> IX-SSA(-*) <input checked="" type="checkbox"/> IX-EA, IX-EAU <input type="checkbox"/> IX-FA <input type="checkbox"/> IXGW-LC <input type="checkbox"/> IXGW-(T)GW <input type="checkbox"/> Intercom App <input checked="" type="checkbox"/> IX-SS-2G <input checked="" type="checkbox"/> IX-RS-* <input checked="" type="checkbox"/> IX-SOFT <input type="checkbox"/> IXW-MA <input type="checkbox"/> IX-SPMIC <input type="checkbox"/> VoIP Phone <input checked="" type="checkbox"/> IX-DVM
Description	Set the play count of ringback tone for outgoing call.
Settings	<ul style="list-style-type: none"> • Infinite: The ringback tone continues to play for the amount of time configured in "Call Timeout◆ (→page 124)". • 1 - 20 times For IXG-MK, change the setting on the screen of the station.

■ Call Destination ([contact input 1 - 4] only)

Compatible type	<input type="checkbox"/> IXG-2C7(-*) <input checked="" type="checkbox"/> IXG-MK <input checked="" type="checkbox"/> IX-MV7-* <input type="checkbox"/> IXG-DM7(-*) <input type="checkbox"/> IX-DA, IX-DB <input type="checkbox"/> IX-BA, IX-BB <input type="checkbox"/> IX-DV, IX-DVF(-*) <input type="checkbox"/> IX-SSA(-*) <input type="checkbox"/> IX-EA, IX-EAU <input type="checkbox"/> IX-FA <input type="checkbox"/> IXGW-LC <input type="checkbox"/> IXGW-(T)GW <input type="checkbox"/> Intercom App <input type="checkbox"/> IX-SS-2G <input type="checkbox"/> IX-RS-* <input type="checkbox"/> IX-SOFT <input type="checkbox"/> IXW-MA <input type="checkbox"/> IX-SPMIC <input type="checkbox"/> VoIP Phone <input type="checkbox"/> IX-DVM
Description	<p>To configure IX-MV7-*: Configure the call destination group and call priority. Enter the group number directly, or click [Open] to choose a group.</p> <p>To configure IXG-MK: Set the destination unit and priority of calls. Click "Select Unit" - [Select] and select the unit.</p>
Settings	<ul style="list-style-type: none"> • Number: 01 to 99. Select from groups registered in "Group (→page 114)". • Priority: Normal/ Priority/ Urgent • Building Number, Unit Number, Unit Name: The unit registered as a call destination in "Station List (→page 104)" and "Mobile App and Phone List (→page 107)".

■ Standard Mode Settings

Compatible type	<input type="checkbox"/> IXG-2C7(-*) <input type="checkbox"/> IXG-MK <input type="checkbox"/> IX-MV7-* <input checked="" type="checkbox"/> IXG-DM7(-*) <input checked="" type="checkbox"/> IX-DA, IX-DB <input checked="" type="checkbox"/> IX-BA, IX-BB <input checked="" type="checkbox"/> IX-DV, IX-DVF(-*) <input checked="" type="checkbox"/> IX-SSA(-*) <input checked="" type="checkbox"/> IX-EA, IX-EAU <input type="checkbox"/> IX-FA <input type="checkbox"/> IXGW-LC <input type="checkbox"/> IXGW-(T)GW <input type="checkbox"/> Intercom App <input checked="" type="checkbox"/> IX-SS-2G <input checked="" type="checkbox"/> IX-RS-* <input type="checkbox"/> IX-SOFT <input type="checkbox"/> IXW-MA <input type="checkbox"/> IX-SPMIC <input type="checkbox"/> VoIP Phone <input checked="" type="checkbox"/> IX-DVM
Description	<p>If "Call Method (→page 123)" was set to "Standard Destination," configure the call destination group and call priority.</p>
Settings	<ul style="list-style-type: none"> • Call Destination: 01-10. Select from groups registered in "Called Stations (Door/Sub Stations) (→page 120)". • When making an outgoing call by operating the main unit or pressing the call button, IXG-DM7(-*) is set to "01" and cannot be changed, while IX-DA, IX-DB, IX-BA, IX-BB are set to "10" and cannot be changed. • Priority: Normal/ Priority/ Urgent • When making an outgoing call by operating the main unit or pressing the call button, the priority of IXG-DM7(-*) is set to "Priority" and cannot be changed.

■ Destination Dwell 1-8

Compatible type	<input type="checkbox"/> IXG-2C7(-*) <input type="checkbox"/> IXG-MK <input type="checkbox"/> IX-MV7-* <input type="checkbox"/> IXG-DM7(-*) <input type="checkbox"/> IX-DA, IX-DB <input type="checkbox"/> IX-BA, IX-BB <input checked="" type="checkbox"/> IX-DV, IX-DVF(-*) <input checked="" type="checkbox"/> IX-SSA(-*) <input checked="" type="checkbox"/> IX-EA, IX-EAU <input type="checkbox"/> IX-FA <input type="checkbox"/> IXGW-LC <input type="checkbox"/> IXGW-(T)GW <input type="checkbox"/> Intercom App <input checked="" type="checkbox"/> IX-SS-2G <input checked="" type="checkbox"/> IX-RS-* <input type="checkbox"/> IX-SOFT <input type="checkbox"/> IXW-MA <input type="checkbox"/> IX-SPMIC <input type="checkbox"/> VoIP Phone <input checked="" type="checkbox"/> IX-DVM
Description	<p>If "Call Method (→page 123)" was set to "Change Destination by Time Delay," configure the switchover call destination group and call priority. A maximum of 8 groups can be configured. Groups will switch in order at each time set in "Destination Dwell Time."</p>
Settings	<ul style="list-style-type: none"> • Call Destination: 01 - 10. Select from groups registered in "Called Stations (Door/Sub Stations) (→page 120)". • Priority: Normal/Priority/Urgent

■ Destination Dwell Time◆

Compatible type	<input type="checkbox"/> IXG-2C7(-*) <input type="checkbox"/> IXG-MK <input type="checkbox"/> IX-MV7-* <input type="checkbox"/> IXG-DM7(-*) <input type="checkbox"/> IX-DA, IX-DB <input type="checkbox"/> IX-BA, IX-BB <input checked="" type="checkbox"/> IX-DV, IX-DVF(-*) <input checked="" type="checkbox"/> IX-SSA(-*) <input checked="" type="checkbox"/> IX-EA, IX-EAU <input type="checkbox"/> IX-FA <input type="checkbox"/> IXGW-LC <input type="checkbox"/> IXGW-(T)GW <input type="checkbox"/> Intercom App <input checked="" type="checkbox"/> IX-SS-2G <input checked="" type="checkbox"/> IX-RS-* <input type="checkbox"/> IX-SOFT <input type="checkbox"/> IXW-MA <input type="checkbox"/> IX-SPMIC <input type="checkbox"/> VoIP Phone <input checked="" type="checkbox"/> IX-DVM
Description	<p>"Call Method (→page 123)" was set to "Change Destination by Time Delay," set the call destination group switch time.</p>
Settings	<p>10-600 sec (by 1 sec)</p>

4.2.1.1 Weekly Schedule

Configure this if "[Call Method \(→page 123\)](#)" was set to "Change Destination by Schedule."

Configure the call destination switch time, call destination group, and call priority for each day of the week from Sunday to Saturday. 12 schedules can be set for each day.

Move row

Up to 50 station number rows can be displayed at a time. Switch the screen as follows.

[Previous]: Display the previous 50 rows.

[Next]: Display the next 50 rows.

[Apply]: Enter the station number and click **[Apply]** to move the cursor to the row of the station number that was entered.

Weekly Schedule

Select the day of week and schedule range to configure to display on the Settings screen.

["How to perform Schedule View Adjustment \(→page 128\)"](#)

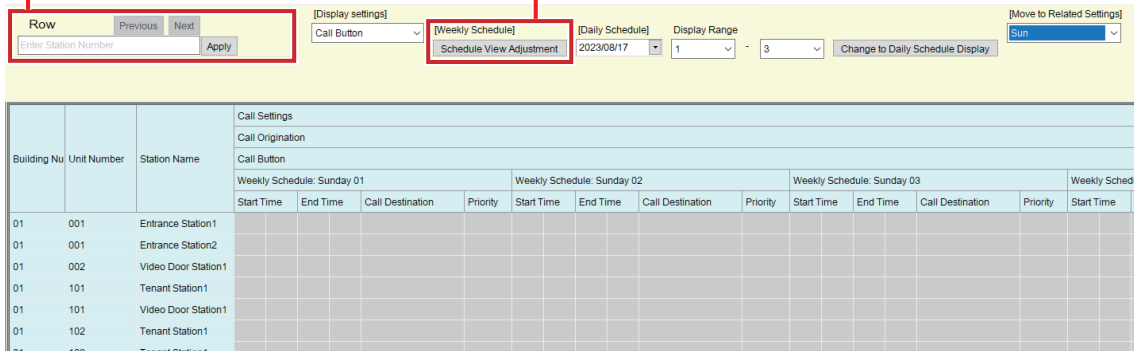

Start Time

Compatible type	<input type="checkbox"/> IXG-2C7(-*) <input type="checkbox"/> IXG-MK <input type="checkbox"/> IX-MV7-* <input type="checkbox"/> IXG-DM7(-*) <input type="checkbox"/> IX-DA, IX-DB <input type="checkbox"/> IX-BA, IX-BB <input checked="" type="checkbox"/> IX-DV, IX-DVF(-*) <input checked="" type="checkbox"/> IX-SSA(-*) <input checked="" type="checkbox"/> IX-EA, IX-EAU <input type="checkbox"/> IX-FA <input type="checkbox"/> IXGW-LC <input type="checkbox"/> IXGW-(T)GW <input type="checkbox"/> Intercom App <input checked="" type="checkbox"/> IX-SS-2G <input checked="" type="checkbox"/> IX-RS-* <input type="checkbox"/> IX-SOFT <input type="checkbox"/> IXW-MA <input type="checkbox"/> IX-SPMIC <input type="checkbox"/> VoIP Phone <input checked="" type="checkbox"/> IX-DVM
Description	Set the time to start changing the call destination.
Settings	00:00 - 23:59

End Time

Compatible type	<input type="checkbox"/> IXG-2C7(-*) <input type="checkbox"/> IXG-MK <input type="checkbox"/> IX-MV7-* <input type="checkbox"/> IXG-DM7(-*) <input type="checkbox"/> IX-DA, IX-DB <input type="checkbox"/> IX-BA, IX-BB <input checked="" type="checkbox"/> IX-DV, IX-DVF(-*) <input checked="" type="checkbox"/> IX-SSA(-*) <input checked="" type="checkbox"/> IX-EA, IX-EAU <input type="checkbox"/> IX-FA <input type="checkbox"/> IXGW-LC <input type="checkbox"/> IXGW-(T)GW <input type="checkbox"/> Intercom App <input checked="" type="checkbox"/> IX-SS-2G <input checked="" type="checkbox"/> IX-RS-* <input type="checkbox"/> IX-SOFT <input type="checkbox"/> IXW-MA <input type="checkbox"/> IX-SPMIC <input type="checkbox"/> VoIP Phone <input checked="" type="checkbox"/> IX-DVM
Description	Configure the time to stop switching the call destination group. If this is set earlier than "Start Time," the end time will be that time on the following day.
Settings	00:00 - 23:59

■ Call Destination

Compatible type	<input type="checkbox"/> IXG-2C7(-*) <input type="checkbox"/> IXG-MK <input type="checkbox"/> IX-MV7-* <input type="checkbox"/> IXG-DM7(-*) <input type="checkbox"/> IX-DA, IX-DB <input type="checkbox"/> IX-BA, IX-BB <input checked="" type="checkbox"/> IX-DV, IX-DVF(-*) <input checked="" type="checkbox"/> IX-SSA(-*) <input checked="" type="checkbox"/> IX-EA, IX-EAU <input type="checkbox"/> IX-FA <input type="checkbox"/> IXGW-LC <input type="checkbox"/> IXGW-(T)GW <input type="checkbox"/> Intercom App <input checked="" type="checkbox"/> IX-SS-2G <input checked="" type="checkbox"/> IX-RS-* <input type="checkbox"/> IX-SOFT <input type="checkbox"/> IXW-MA <input type="checkbox"/> IX-SPMIC <input type="checkbox"/> VoIP Phone <input checked="" type="checkbox"/> IX-DVM
Description	Set the call destination to change within the schedule.
Settings	01 - 10. Select from groups registered in “Called Stations (Door/Sub Stations) (→page 120)” .

■ Priority

Compatible type	<input type="checkbox"/> IXG-2C7(-*) <input type="checkbox"/> IXG-MK <input type="checkbox"/> IX-MV7-* <input type="checkbox"/> IXG-DM7(-*) <input type="checkbox"/> IX-DA, IX-DB <input type="checkbox"/> IX-BA, IX-BB <input checked="" type="checkbox"/> IX-DV, IX-DVF(-*) <input checked="" type="checkbox"/> IX-SSA(-*) <input checked="" type="checkbox"/> IX-EA, IX-EAU <input type="checkbox"/> IX-FA <input type="checkbox"/> IXGW-LC <input type="checkbox"/> IXGW-(T)GW <input type="checkbox"/> Intercom App <input checked="" type="checkbox"/> IX-SS-2G <input checked="" type="checkbox"/> IX-RS-* <input type="checkbox"/> IX-SOFT <input type="checkbox"/> IXW-MA <input type="checkbox"/> IX-SPMIC <input type="checkbox"/> VoIP Phone <input checked="" type="checkbox"/> IX-DVM
Description	Set the priority of calls.
Settings	<ul style="list-style-type: none"> • Normal • Priority • Urgent

How to perform Schedule View Adjustment

Configure the day and schedule range shown on the Settings screen for the weekly schedule.

The display can be filtered to show only the day and schedule to configure.

Click **[Schedule View Adjustment]** to display the following screen.

1. Select the day of week to display from "Day." (Multiple selections allowed.)
 - To select or unselect all days of the week at once, click **[Select]** or **[Unselect]**.
 - By default, all days are shown.
2. Select the range of schedules to display (1 to 12) that can be configured for each day of week.
 - By default, the range of 1 - 3 is displayed.
3. Click **[OK]**.
 - Click **[Cancel]** to cancel configuring the schedule display.

4.2.1.2 Daily Schedule

Configure this if "[Call Method \(→page 123\)](#)" was set to "Change Destination by Schedule."

Configure the call destination switch time, call destination group, and call priority in 1-day units. A schedule to the end of the month one year from the set day can be configured. 12 schedules can be set for each day.

Move row

Up to 50 station number rows can be displayed at a time. Switch the screen as follows.

[Previous]: Display the previous 50 rows.

[Next]: Display the next 50 rows.

[Apply]: Enter the station number and click **[Apply]** to move the cursor to the row of the station number that was entered.

Daily schedule

Select the date and schedule range to configure. The Settings screen is displayed.

1. Select the date from the drop down menu.
2. Select the range of schedules to display (1 to 12) that can be configured for each day.
 - By default, the range of 1 - 3 is displayed.
3. Click **[Change to Daily Schedule Display]**.

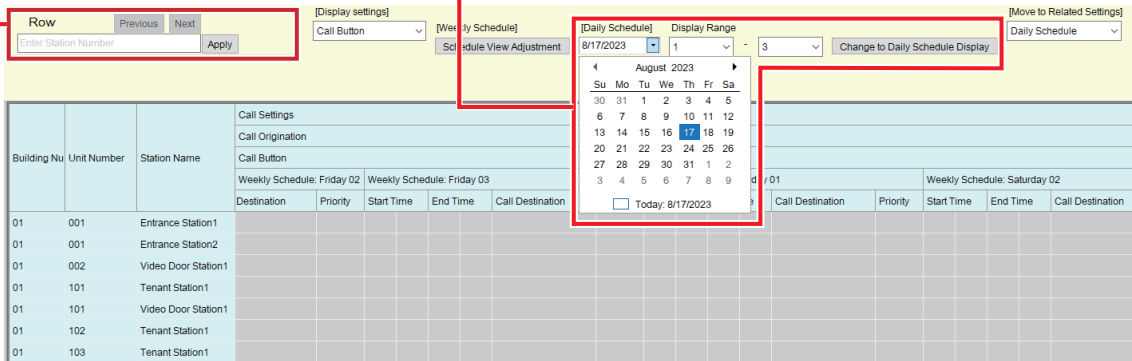

Start Time

Compatible type	<input type="checkbox"/> IXG-2C7(-*) <input type="checkbox"/> IXG-MK <input type="checkbox"/> IX-MV7-* <input type="checkbox"/> IXG-DM7(-*) <input type="checkbox"/> IX-DA, IX-DB <input type="checkbox"/> IX-BA, IX-BB <input checked="" type="checkbox"/> IX-DV, IX-DVF(-*) <input checked="" type="checkbox"/> IX-SSA(-*) <input checked="" type="checkbox"/> IX-EA, IX-EAU <input type="checkbox"/> IX-FA <input type="checkbox"/> IXGW-LC <input type="checkbox"/> IXGW-(T)GW <input type="checkbox"/> Intercom App <input checked="" type="checkbox"/> IX-SS-2G <input checked="" type="checkbox"/> IX-RS-* <input type="checkbox"/> IX-SOFT <input type="checkbox"/> IXW-MA <input type="checkbox"/> IX-SPMIC <input type="checkbox"/> VoIP Phone <input checked="" type="checkbox"/> IX-DVM
Description	Set the time to start changing the call destination.
Settings	00:00 - 23:59

End Time

Compatible type	<input type="checkbox"/> IXG-2C7(-*) <input type="checkbox"/> IXG-MK <input type="checkbox"/> IX-MV7-* <input type="checkbox"/> IXG-DM7(-*) <input type="checkbox"/> IX-DA, IX-DB <input type="checkbox"/> IX-BA, IX-BB <input checked="" type="checkbox"/> IX-DV, IX-DVF(-*) <input checked="" type="checkbox"/> IX-SSA(-*) <input checked="" type="checkbox"/> IX-EA, IX-EAU <input type="checkbox"/> IX-FA <input type="checkbox"/> IXGW-LC <input type="checkbox"/> IXGW-(T)GW <input type="checkbox"/> Intercom App <input checked="" type="checkbox"/> IX-SS-2G <input checked="" type="checkbox"/> IX-RS-* <input type="checkbox"/> IX-SOFT <input type="checkbox"/> IXW-MA <input type="checkbox"/> IX-SPMIC <input type="checkbox"/> VoIP Phone <input checked="" type="checkbox"/> IX-DVM
Description	Configure the time to stop switching the call destination group. If this is set earlier than "Start Time," the end time will be that time on the following day.
Settings	00:00 - 23:59

■ Call Destination

Compatible type	<input type="checkbox"/> IXG-2C7(-*) <input type="checkbox"/> IXG-MK <input type="checkbox"/> IX-MV7-* <input type="checkbox"/> IXG-DM7(-*) <input type="checkbox"/> IX-DA, IX-DB <input type="checkbox"/> IX-BA, IX-BB <input checked="" type="checkbox"/> IX-DV, IX-DVF(-*) <input checked="" type="checkbox"/> IX-SSA(-*) <input checked="" type="checkbox"/> IX-EA, IX-EAU <input type="checkbox"/> IX-FA <input type="checkbox"/> IXGW-LC <input type="checkbox"/> IXGW-(T)GW <input type="checkbox"/> Intercom App <input checked="" type="checkbox"/> IX-SS-2G <input checked="" type="checkbox"/> IX-RS-* <input type="checkbox"/> IX-SOFT <input type="checkbox"/> IXW-MA <input type="checkbox"/> IX-SPMIC <input type="checkbox"/> VoIP Phone <input checked="" type="checkbox"/> IX-DVM
Description	Set the call destination to change within the schedule.
Settings	01 - 10. Select from groups registered in " Called Stations (Door/Sub Stations) (→page 120) ".

■ Priority

Compatible type	<input type="checkbox"/> IXG-2C7(-*) <input type="checkbox"/> IXG-MK <input type="checkbox"/> IX-MV7-* <input type="checkbox"/> IXG-DM7(-*) <input type="checkbox"/> IX-DA, IX-DB <input type="checkbox"/> IX-BA, IX-BB <input checked="" type="checkbox"/> IX-DV, IX-DVF(-*) <input checked="" type="checkbox"/> IX-SSA(-*) <input checked="" type="checkbox"/> IX-EA, IX-EAU <input type="checkbox"/> IX-FA <input type="checkbox"/> IXGW-LC <input type="checkbox"/> IXGW-(T)GW <input type="checkbox"/> Intercom App <input checked="" type="checkbox"/> IX-SS-2G <input checked="" type="checkbox"/> IX-RS-* <input type="checkbox"/> IX-SOFT <input type="checkbox"/> IXW-MA <input type="checkbox"/> IX-SPMIC <input type="checkbox"/> VoIP Phone <input checked="" type="checkbox"/> IX-DVM
Description	Set the priority of calls.
Settings	<ul style="list-style-type: none"> • Normal • Priority • Urgent

4.2.2 Tone Settings

Configure the busy tone and error tone when making an outgoing call.

■ Busy Tone

Compatible type	<input checked="" type="checkbox"/> IXG-2C7(-*) <input checked="" type="checkbox"/> IXG-MK <input checked="" type="checkbox"/> IX-MV7-* <input checked="" type="checkbox"/> IXG-DM7(-*) <input checked="" type="checkbox"/> IX-DA, IX-DB <input checked="" type="checkbox"/> IX-BA, IX-BB <input checked="" type="checkbox"/> IX-DV, IX-DVF(-*) <input checked="" type="checkbox"/> IX-SSA(-*) <input checked="" type="checkbox"/> IX-EA, IX-EAU <input type="checkbox"/> IX-FA <input type="checkbox"/> IXGW-LC <input type="checkbox"/> IXGW-(T)GW <input type="checkbox"/> Intercom App <input checked="" type="checkbox"/> IX-SS-2G <input checked="" type="checkbox"/> IX-RS-* <input checked="" type="checkbox"/> IX-SOFT <input type="checkbox"/> IXW-MA <input type="checkbox"/> IX-SPMIC <input type="checkbox"/> VoIP Phone <input checked="" type="checkbox"/> IX-DVM
Description	Select the sound to be played when call destination station is busy.
Settings	<ul style="list-style-type: none"> • None (except IX-DA, IX-DB, IX-BA, IX-BB) • Call Pattern 1 • Call Pattern 2 • Call Pattern 3 • Call Pattern 4 • Call Pattern 5 • Call Pattern 6 • Call Pattern 7 (IX-EA and IX-DVM only) • Tremolo Sound • Busy Response Tone (IX-DA, IX-DB, IX-BA, IX-BB: Busy Tone) • On Hold • Operation Sound (except IX-SOFT) • Error (IX-DA, IX-DB, IX-BA, IX-BB: Error Tone) • Pre Tone 1 (except IX-DA, IX-DB, IX-BA, IX-BB) • Pre Tone 2 (except IX-DA, IX-DB, IX-BA, IX-BB) • Pre Tone 3 (except IX-DA, IX-DB, IX-BA, IX-BB) • Communication End Pretone (except IX-DA, IX-DB, IX-BA, IX-BB) • Call Queue Notification (except IX-DA, IX-DB, IX-BA, IX-BB) • Waiting Reply Tone (except IX-DA, IX-DB, IX-BA, IX-BB) • Select a sound that is registered in "Custom Sound Registry (→page 117)". IXG-2C7(-*) is set to "Busy Response Tone" and cannot be changed.

■ Error Tone (Call Failed)

Compatible type	<input type="checkbox"/> IXG-2C7(-*) <input type="checkbox"/> IXG-MK <input type="checkbox"/> IX-MV7-* <input checked="" type="checkbox"/> IXG-DM7(-*) <input checked="" type="checkbox"/> IX-DA, IX-DB <input checked="" type="checkbox"/> IX-BA, IX-BB <input checked="" type="checkbox"/> IX-DV, IX-DVF(-*) <input checked="" type="checkbox"/> IX-SSA(-*) <input checked="" type="checkbox"/> IX-EA, IX-EAU <input type="checkbox"/> IX-FA <input type="checkbox"/> IXGW-LC <input type="checkbox"/> IXGW-(T)GW <input type="checkbox"/> Intercom App <input checked="" type="checkbox"/> IX-SS-2G <input checked="" type="checkbox"/> IX-RS-* <input type="checkbox"/> IX-SOFT <input type="checkbox"/> IXW-MA <input type="checkbox"/> IX-SPMIC <input type="checkbox"/> VoIP Phone <input checked="" type="checkbox"/> IX-DVM
Description	Select the sound to be played when outgoing call has failed.
Settings	<ul style="list-style-type: none"> • None (except IX-DA, IX-DB, IX-BA, IX-BB) • Call Pattern 1 • Call Pattern 2 • Call Pattern 3 • Call Pattern 4 • Call Pattern 5 • Call Pattern 6 • Call Pattern 7 (IX-EA and IX-DVM only) • Tremolo Sound • Busy Response Tone (IX-DA, IX-DB, IX-BA, IX-BB: Busy Tone) • On Hold • Operation Sound • Error (IX-DA, IX-DB, IX-BA, IX-BB: Error Tone) • Pre Tone 1 (except IX-DA, IX-DB, IX-BA, IX-BB) • Pre Tone 2 (except IX-DA, IX-DB, IX-BA, IX-BB) • Pre Tone 3 (except IX-DA, IX-DB, IX-BA, IX-BB) • Communication End Pretone (except IX-DA, IX-DB, IX-BA, IX-BB) • Call Queue Notification (except IX-DA, IX-DB, IX-BA, IX-BB) • Waiting Reply Tone (except IX-DA, IX-DB, IX-BA, IX-BB) • Select a sound that is registered in "Custom Sound Registry (→page 117)".

4.2.3 Call Restart Function

■ Call Restart Function

Compatible type	<input type="checkbox"/> IXG-2C7(-*) <input type="checkbox"/> IXG-MK <input type="checkbox"/> IX-MV7-* <input type="checkbox"/> IXG-DM7(-*) <input type="checkbox"/> IX-DA, IX-DB <input type="checkbox"/> IX-BA, IX-BB <input checked="" type="checkbox"/> IX-DV, IX-DVF(-*) <input checked="" type="checkbox"/> IX-SSA(-*) <input checked="" type="checkbox"/> IX-EA, IX-EAU <input type="checkbox"/> IX-FA <input type="checkbox"/> IXGW-LC <input type="checkbox"/> IXGW-(T)GW <input type="checkbox"/> Intercom App <input checked="" type="checkbox"/> IX-SS-2G <input checked="" type="checkbox"/> IX-RS-* <input type="checkbox"/> IX-SOFT <input type="checkbox"/> IXW-MA <input type="checkbox"/> IX-SPMIC <input type="checkbox"/> VoIP Phone <input checked="" type="checkbox"/> IX-DVM
Description	<p>Enable/Disable the call restart function.</p> <p>Call Restart Function: If the station is reset during an outgoing call, this function automatically restarts the call after the station resets. However, a call may only be restarted up to twice.</p>
Settings	<ul style="list-style-type: none"> • Enable • Disable

4.3 Incoming Call

Configures settings related to incoming calls.

Move row

Up to 50 station number rows can be displayed at a time. Switch the screen as follows.

[Previous]: Display the previous 50 rows.

[Next]: Display the next 50 rows.

[Apply]: Enter the station number and click **[Apply]** to move the cursor to the row of the station number that was entered.

Move column

Up to 50 station number columns can be displayed at a time. Switch the screen as follows.

[Previous]: Display the previous 50 columns.

[Next]: Display the next 50 columns.

[Apply]: Enter the station number and click **[Apply]** to move the cursor to the column of the station number that was entered.

Row Previous Next

Enter Station Number Apply

Column Previous Next

Enter Station Number Apply

Building Number	Unit Number	Station Name	Call Settings				01 / 001 / 010010 / Entrance Station1 / IXG-DM7(-*)							
			Incoming Call		Ringtone	Ringback Tone Count [time(s)]	Call Button			Option Input				
			Call Answer Settings	Auto Answer			Normal	Priority	Urgent	Normal	Priority	Urgent		
01	001	Entrance Station 1	ON		Call Pattern 3	Infinite	-	-	-	-	-	-	-	-
01	001	Entrance Station2	ON		Call Pattern 3	Infinite	-	-	-	-	-	-	-	-
01	0001	Master Station 1	ON				Call Pattern	Call Pattern	Call Pattern	-	-	-	-	-
01	101	Tenant Station 1	ON		Call Pattern 1	Infinite	Call Pattern	Call Pattern	Call Pattern	-	-	-	-	-
01	101	Video Door Station1	ON		Call Pattern 3	Infinite	-	-	-	-	-	-	-	-

4.3.1 Call Answer Settings

■ Auto Answer

Compatible type	<input checked="" type="checkbox"/> IXG-2C7(-*) <input checked="" type="checkbox"/> IXG-MK <input checked="" type="checkbox"/> IX-MV7-* <input checked="" type="checkbox"/> IXG-DM7(-*) <input type="checkbox"/> IX-DA, IX-DB <input type="checkbox"/> IX-BA, IX-BB <input checked="" type="checkbox"/> IX-DV, IX-DVF(-*) <input checked="" type="checkbox"/> IX-SSA(-*) <input checked="" type="checkbox"/> IX-EA, IX-EAU <input type="checkbox"/> IX-FA <input type="checkbox"/> IXGW-LC <input type="checkbox"/> IXGW-(T)GW <input type="checkbox"/> Intercom App <input checked="" type="checkbox"/> IX-SS-2G <input checked="" type="checkbox"/> IX-RS-* <input checked="" type="checkbox"/> IX-SOFT <input type="checkbox"/> IXW-MA <input type="checkbox"/> IX-SPMIC <input type="checkbox"/> VoIP Phone <input checked="" type="checkbox"/> IX-DVM
Description	Configure whether to automatically answer when an individual call is received from IX-MV7-* or another station in the same unit. Auto Answer: When an incoming call is received, this function automatically begins communication without the user having to answer the call. Calls that were transferred are not automatically answered.
Settings	<ul style="list-style-type: none"> • OFF: Auto answer disabled. • ON: Auto answer enabled. For IXG-MK, change the setting on the screen of the station.

! Important

- If the software version of IXG-DM7(-*) is earlier than 3.00, do not set auto answer to "OFF." Otherwise, incoming calls cannot be received.
- For IX-DV, IX-DVF(-*), IX-SSA(-*), IX-SS-2G, IX-EA, and IX-DVM, if auto answer was set to "OFF," be sure to configure one of the following. Otherwise, incoming calls cannot be received.
 - Set "Call Button Function" to "Call, Answer Call, End Communication" in Administrator mode.
 - Set "Option Input" - "Function" to "Answer Call / Page" in Administrator mode.

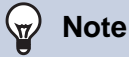
**Note**

- For IX-DA, IX-DB, IX-BA, IX-BB, auto answer is set to "ON" and cannot be changed.

4.3.2 Ringtone

■ Ringtone

Compatible type	<input checked="" type="checkbox"/> IXG-2C7(-*) <input type="checkbox"/> IXG-MK <input type="checkbox"/> IX-MV7-* <input checked="" type="checkbox"/> IXG-DM7(-*) <input type="checkbox"/> IX-DA, IX-DB <input type="checkbox"/> IX-BA, IX-BB <input checked="" type="checkbox"/> IX-DV, IX-DVF(-*) <input checked="" type="checkbox"/> IX-SSA(-*) <input checked="" type="checkbox"/> IX-EA, IX-EAU <input type="checkbox"/> IX-FA <input type="checkbox"/> IXGW-LC <input type="checkbox"/> IXGW-(T)GW <input type="checkbox"/> Intercom App <input checked="" type="checkbox"/> IX-SS-2G <input checked="" type="checkbox"/> IX-RS-* <input type="checkbox"/> IX-SOFT <input type="checkbox"/> IXW-MA <input type="checkbox"/> IX-SPMIC <input type="checkbox"/> VoIP Phone <input checked="" type="checkbox"/> IX-DVM
Description	Select the ringtone to be played for incoming calls when performing operations on the stations and when receiving incoming calls through contact input.
Settings	<ul style="list-style-type: none"> • None • Call Pattern 1 • Call Pattern 2 • Call Pattern 3 • Call Pattern 4 • Call Pattern 5 • Call Pattern 6 • Call Pattern 7 (IX-EA and IX-DVM only) • Tremolo Sound • Busy Response Tone • On Hold • Operation Sound • Error • Pre Tone 1 • Pre Tone 2 • Pre Tone 3 • Communication End Pretone • Call Queue Notification • Waiting Reply Tone • Select a sound that is registered in "Custom Sound Registry (→page 117)". For IXG-2C7(-*), change the setting on the screen of the station.

■ Ringback Tone Count [time(s)]

Compatible type	<input checked="" type="checkbox"/> IXG-2C7(-*) <input type="checkbox"/> IXG-MK <input type="checkbox"/> IX-MV7-* <input checked="" type="checkbox"/> IXG-DM7(-*) <input type="checkbox"/> IX-DA, IX-DB <input type="checkbox"/> IX-BA, IX-BB <input checked="" type="checkbox"/> IX-DV, IX-DVF(-*) <input checked="" type="checkbox"/> IX-SSA(-*) <input checked="" type="checkbox"/> IX-EA, IX-EAU <input type="checkbox"/> IX-FA <input type="checkbox"/> IXGW-LC <input type="checkbox"/> IXGW-(T)GW <input type="checkbox"/> Intercom App <input checked="" type="checkbox"/> IX-SS-2G <input checked="" type="checkbox"/> IX-RS-* <input type="checkbox"/> IX-SOFT <input type="checkbox"/> IXW-MA <input type="checkbox"/> IX-SPMIC <input type="checkbox"/> VoIP Phone <input checked="" type="checkbox"/> IX-DVM
Description	Sets the play count of the ringtone for incoming calls when performing operations on the stations and when receiving incoming calls through contact input.
Settings	<ul style="list-style-type: none"> • Infinite: The ringtone continues until the call is connected or the caller stops calling. • 1 - 20 times For IXG-2C7(-*), change the setting on the screen of the station.

■ Call Button

Compatible type	<input checked="" type="checkbox"/> IXG-2C7(-*) <input checked="" type="checkbox"/> IXG-MK <input checked="" type="checkbox"/> IX-MV7-* <input type="checkbox"/> IXG-DM7(-*) <input type="checkbox"/> IX-DA, IX-DB <input type="checkbox"/> IX-BA, IX-BB <input type="checkbox"/> IX-DV, IX-DVF(-*) <input type="checkbox"/> IX-SSA(-*) <input type="checkbox"/> IX-EA, IX-EAU <input type="checkbox"/> IX-FA <input type="checkbox"/> IXGW-LC <input type="checkbox"/> IXGW-(T)GW <input type="checkbox"/> Intercom App <input type="checkbox"/> IX-SS-2G <input type="checkbox"/> IX-RS-* <input checked="" type="checkbox"/> IX-SOFT <input type="checkbox"/> IXW-MA <input type="checkbox"/> IX-SPMIC <input type="checkbox"/> VoIP Phone <input type="checkbox"/> IX-DVM
Description	<p>Set the ringtone when an incoming call is receiving by operating the main unit. This can be set for each caller.</p> <p>This can be set for each call priority.</p>
Settings	<ul style="list-style-type: none"> • None • Call Pattern 1 • Call Pattern 2 • Call Pattern 3 • Call Pattern 4 • Call Pattern 5 • Call Pattern 6 • Tremolo Sound • Busy Response Tone • On Hold • Operation Sound (except IX-SOFT) • Error • Pre Tone 1 • Pre Tone 2 • Pre Tone 3 • Communication End Pretone • Call Queue Notification • Waiting Reply Tone • Select a sound that is registered in “Custom Sound Registry (→page 117)”. IXG-2C7(-*) is set to "Call Pattern 1" and cannot be changed. For IXG-MK, change the setting on the screen of the station.

■ Option Input

Compatible type	<input checked="" type="checkbox"/> IXG-2C7(-*) <input checked="" type="checkbox"/> IXG-MK <input checked="" type="checkbox"/> IX-MV7-* <input type="checkbox"/> IXG-DM7(-*) <input type="checkbox"/> IX-DA, IX-DB <input type="checkbox"/> IX-BA, IX-BB <input type="checkbox"/> IX-DV, IX-DVF(-*) <input type="checkbox"/> IX-SSA(-*) <input type="checkbox"/> IX-EA, IX-EAU <input type="checkbox"/> IX-FA <input type="checkbox"/> IXGW-LC <input type="checkbox"/> IXGW-(T)GW <input type="checkbox"/> Intercom App <input type="checkbox"/> IX-SS-2G <input type="checkbox"/> IX-RS-* <input checked="" type="checkbox"/> IX-SOFT <input type="checkbox"/> IXW-MA <input type="checkbox"/> IX-SPMIC <input type="checkbox"/> VoIP Phone <input type="checkbox"/> IX-DVM
Description	Set the ringtone when a contact input call is received. This can be set for each caller. This can be set for each call priority.
Settings	<ul style="list-style-type: none"> • None • Call Pattern 1 • Call Pattern 2 • Call Pattern 3 • Call Pattern 4 • Call Pattern 5 • Call Pattern 6 • Tremolo Sound • Busy Response Tone • On Hold • Operation Sound (except IX-SOFT) • Error • Pre Tone 1 • Pre Tone 2 • Pre Tone 3 • Communication End Pretone • Call Queue Notification • Waiting Reply Tone • Select a sound that is registered in "Custom Sound Registry (→page 117)". IXG-2C7(-*) is set to "Call Pattern 2" and cannot be changed. For IXG-MK, change the setting on the screen of the station.

■ Call Button Ringtone Count [time(s)]

Compatible type	<input checked="" type="checkbox"/> IXG-2C7(-*) <input checked="" type="checkbox"/> IXG-MK <input checked="" type="checkbox"/> IX-MV7-* <input type="checkbox"/> IXG-DM7(-*) <input type="checkbox"/> IX-DA, IX-DB <input type="checkbox"/> IX-BA, IX-BB <input type="checkbox"/> IX-DV, IX-DVF(-*) <input type="checkbox"/> IX-SSA(-*) <input type="checkbox"/> IX-EA, IX-EAU <input type="checkbox"/> IX-FA <input type="checkbox"/> IXGW-LC <input type="checkbox"/> IXGW-(T)GW <input type="checkbox"/> Intercom App <input type="checkbox"/> IX-SS-2G <input type="checkbox"/> IX-RS-* <input checked="" type="checkbox"/> IX-SOFT <input type="checkbox"/> IXW-MA <input type="checkbox"/> IX-SPMIC <input type="checkbox"/> VoIP Phone <input type="checkbox"/> IX-DVM
Description	Set the play count of ringback tone for incoming call from call button.
Settings	<ul style="list-style-type: none"> • Infinite: The ringtone continues until the call is connected or the caller stops calling. • 1 - 20 times IXG-2C7(-*) is set to "Infinite" and cannot be changed. For IXG-MK, change the setting on the screen of the station.

■ Option Input Ringtone Count [time(s)]

Compatible type	<input checked="" type="checkbox"/> IXG-2C7(-*) <input checked="" type="checkbox"/> IXG-MK <input checked="" type="checkbox"/> IX-MV7-* <input type="checkbox"/> IXG-DM7(-*) <input type="checkbox"/> IX-DA, IX-DB <input type="checkbox"/> IX-BA, IX-BB <input type="checkbox"/> IX-DV, IX-DVF(-*) <input type="checkbox"/> IX-SSA(-*) <input type="checkbox"/> IX-EA, IX-EAU <input type="checkbox"/> IX-FA <input type="checkbox"/> IXGW-LC <input type="checkbox"/> IXGW-(T)GW <input type="checkbox"/> Intercom App <input type="checkbox"/> IX-SS-2G <input type="checkbox"/> IX-RS-* <input checked="" type="checkbox"/> IX-SOFT <input type="checkbox"/> IXW-MA <input type="checkbox"/> IX-SPMIC <input type="checkbox"/> VoIP Phone <input type="checkbox"/> IX-DVM
Description	Set the play count of ringback tone for incoming call from the option input.
Settings	<ul style="list-style-type: none"> • Infinite: The ringtone continues until the call is connected or the caller stops calling. • 1 - 20 times IXG-2C7(-*) is set to "Infinite" and cannot be changed. For IXG-MK, change the setting on the screen of the station.

4.3.3 VoIP Phone

■ VoIP Phone Call Priority

Compatible type	<input checked="" type="checkbox"/> IXG-2C7(-*) <input checked="" type="checkbox"/> IXG-MK <input checked="" type="checkbox"/> IX-MV7-* <input checked="" type="checkbox"/> IXG-DM7(-*) <input type="checkbox"/> IX-DA, IX-DB <input type="checkbox"/> IX-BA, IX-BB <input checked="" type="checkbox"/> IX-DV, IX-DVF(-*) <input checked="" type="checkbox"/> IX-SSA(-*) <input checked="" type="checkbox"/> IX-EA, IX-EAU <input type="checkbox"/> IX-FA <input type="checkbox"/> IXGW-LC <input type="checkbox"/> IXGW-(T)GW <input type="checkbox"/> Intercom App <input checked="" type="checkbox"/> IX-SS-2G <input checked="" type="checkbox"/> IX-RS-* <input checked="" type="checkbox"/> IX-SOFT <input type="checkbox"/> IXW-MA <input type="checkbox"/> IX-SPMIC <input type="checkbox"/> VoIP Phone <input checked="" type="checkbox"/> IX-DVM
Description	Select the call priority from VoIP phones.
Settings	<ul style="list-style-type: none"> • Normal • Priority • Urgent IXG-2C7(-*) is set to "Normal" and cannot be changed.

4.4 Guard Button

Configure the station to call when the "Guard Call Button" is pressed on the Entrance Station or Tenant Station. IXG-MK, IX-MV7-*, IX-SOFT, IX-RS-*, and VoIP Phone stations can be set as call destinations.

Important

- A station cannot be set as a destination unless "IP Address" has been configured for the station in Administrator mode.

■ Select Station

Compatible type	<input checked="" type="checkbox"/> IXG-2C7(-*) <input type="checkbox"/> IXG-MK <input type="checkbox"/> IX-MV7-* <input checked="" type="checkbox"/> IXG-DM7(-*) <input type="checkbox"/> IX-DA, IX-DB <input type="checkbox"/> IX-BA, IX-BB <input type="checkbox"/> IX-DV, IX-DVF(-*) <input type="checkbox"/> IX-SSA(-*) <input type="checkbox"/> IX-EA, IX-EAU <input type="checkbox"/> IX-FA <input type="checkbox"/> IXGW-LC <input type="checkbox"/> IXGW-(T)GW <input checked="" type="checkbox"/> Intercom App <input type="checkbox"/> IX-SS-2G <input type="checkbox"/> IX-RS-* <input type="checkbox"/> IX-SOFT <input type="checkbox"/> IXW-MA <input type="checkbox"/> IX-SPMIC <input type="checkbox"/> VoIP Phone <input type="checkbox"/> IX-DVM
Description	Configure the call destination station (station number). Up to 8 call destination stations can be configured. Enter the station number manually, or click [Select] to select one. The information (station number, building number, unit number, station name) for the configured station is displayed.
Settings	-

■ Mobile Apps and Phone

Compatible type	<input checked="" type="checkbox"/> IXG-2C7(-*) <input type="checkbox"/> IXG-MK <input type="checkbox"/> IX-MV7-* <input checked="" type="checkbox"/> IXG-DM7(-*) <input type="checkbox"/> IX-DA, IX-DB <input type="checkbox"/> IX-BA, IX-BB <input type="checkbox"/> IX-DV, IX-DVF(-*) <input type="checkbox"/> IX-SSA(-*) <input type="checkbox"/> IX-EA, IX-EAU <input type="checkbox"/> IX-FA <input type="checkbox"/> IXGW-LC <input type="checkbox"/> IXGW-(T)GW <input checked="" type="checkbox"/> Intercom App <input type="checkbox"/> IX-SS-2G <input type="checkbox"/> IX-RS-* <input type="checkbox"/> IX-SOFT <input type="checkbox"/> IXW-MA <input type="checkbox"/> IX-SPMIC <input type="checkbox"/> VoIP Phone <input type="checkbox"/> IX-DVM
Description	Configure the unit containing the Intercom App or phone to set as a call destination. A single unit can be configured as a call destination. Enter the building number and unit number of the unit containing the Intercom App or phone manually, or click [Select] to select one. The information (building number, unit number, unit name) for the configured Intercom App or phone call destination is displayed.
Settings	-

5. Move-out Settings (Move-out Settings)

5.1 Move-out

Be sure to perform the move-out process if a resident moves out from a residence with a registered Intercom App or phone, to prevent that resident from using the Intercom App or phone.

You will also need to send a QR code for Intercom App registration to the Tenant Station for the new resident.

The move-out process will initialize unit information settings, and should only be performed when a resident moves out.

Move-out										
Move-out Settings										
Building Number	Move-out								Move-out Status	
	Unit Number	Unit Name	Select	Station Number	Station Name	First Name	Last Name	User Settings Initialized	Apps Deactivated	
	01	101	Residential101	<input type="checkbox"/>	011010	Tenant Station1	-	-	-	-
01	102	Residential102	<input type="checkbox"/>	011020	Tenant Station1	-	-	-	-	
01	103	Residential103	<input type="checkbox"/>	011030	Tenant Station1	-	-	No Registered Apps	-	
01	104	Residential104	<input type="checkbox"/>	011040	Tenant Station1	-	-	No Registered Apps	-	
01	105	Residential105	<input type="checkbox"/>	-	-	-	-	No Registered Apps	-	
01	106	Residential106	<input type="checkbox"/>	011060	Tenant Station1	-	-	No Registered Apps	No Registered Apps	
01	201	Guard201	<input type="checkbox"/>	-	-	Guard201	-	No Registered Apps	-	

List of Residential information in the setting data

How to perform the move-out process

1. In the "List of residences in the setting data," select the unit for which to perform the move-out process.
2. Click **[Move-out]**.
3. Click **[OK]**.
 - Click **[Cancel]** to quit without performing the move-out process.
4. Click **[OK]**.
 - Click **[Cancel]** to quit without performing the move-out process.
5. Enter the "IXG Cloud Server ID or Email Address" and "Password."
6. Click "Login."
 - Login to IXG Cloud Server.
 - Click **[Cancel]** to quit without performing IXG Cloud Server Login.

The following processes will be performed.

- First Name / Last Name: "First Name," and "Last Name" will be returned to their default values.
- User Settings Initialized: The user settings of the Tenant Station will be initialized.
- Intercom App deactivated: The resident who moved out is prevented from using the Intercom App.
- QR code uploaded: A new QR code is sent to the Tenant Station for Intercom App registration.
- Phone settings initialized: The registered phone is initialized.

- IXG Support Tool internal settings initialized: IXG Support Tool settings are initialized.

- 7.** Click **[OK]**.
- 8.** If there is no Tenant Station, generate a PDF of the QR code for Intercom App registration.
[“Export QR Code for App Registration \(→page 80\)”](#)

5.2 Delete Unit Information

Initialize the Unit Name if necessary, such as when a resident moves out.

Delete

Unit Information and registered App will be deleted.

Select	Building Number	Unit Number	Move-out Settings
			Delete Unit Information
			Unit Name
<input type="checkbox"/>	01	0001	Residential203
<input type="checkbox"/>	01	101	Residential101
<input type="checkbox"/>	01	102	Residential102
<input type="checkbox"/>	01	103	Residential103
<input type="checkbox"/>	01	104	Residential104
<input type="checkbox"/>	01	105	Residential105
<input type="checkbox"/>	01	106	Residential106
<input type="checkbox"/>	01	201	Guard201
<input type="checkbox"/>	01	202	Commercial202

List of Residential information in the setting data

How to delete unit information

1. In the "List of residences in the setting data," select the unit for which to initialize the Unit Name.
2. Click **[Delete]**.
 - The "Unit Name" reverts to the default value.
3. Click **[Update]**.
4. Click **[OK]**.

6. Gateway Settings (Advanced Settings)

Compatible type	<input type="checkbox"/> IXG-2C7(-*) <input type="checkbox"/> IXG-MK <input type="checkbox"/> IX-MV7-* <input type="checkbox"/> IXG-DM7(-*) <input type="checkbox"/> IX-DA, IX-DB <input type="checkbox"/> IX-BA, IX-BB <input type="checkbox"/> IX-DV, IX-DVF(-*) <input type="checkbox"/> IX-SSA(-*) <input type="checkbox"/> IX-EA, IX-EAU <input type="checkbox"/> IX-FA <input type="checkbox"/> IXGW-LC <input checked="" type="checkbox"/> IXGW-(T)GW <input type="checkbox"/> Intercom App <input type="checkbox"/> IX-SS-2G <input type="checkbox"/> IX-RS-* <input type="checkbox"/> IX-SOFT <input type="checkbox"/> IXW-MA <input type="checkbox"/> IX-SPMIC <input type="checkbox"/> VoIP Phone <input type="checkbox"/> IX-DVM
-----------------	---

6.1 Gateway SIM Settings

Configure the IXGW-TGW SIM.

6.1.1 APN Settings

6.1.1.1 APN

Description	Set the APN (access point name).
Settings	1-64 alphanumeric characters and symbols

6.1.1.2 User Name

Description	Set the APN user name.
Settings	1-50 alphanumeric characters and symbols

6.1.1.3 Password

Description	Set the APN password.
Settings	1-50 alphanumeric characters and symbols

6.1.1.4 Authentication Type

Description	Set the APN authentication type.
Settings	<ul style="list-style-type: none"> • PAP • CHAP • None

6.1.1.5 APN protocol

Description	Select the APN protocol.
Settings	<ul style="list-style-type: none"> • IPv4 • IPv6 • IPv4v6

6.1.1.6 Network Type

Description	Set the APN network type.
Settings	<ul style="list-style-type: none"> • Automatic • GSM • WCDMA • LTE

6.1.1.7 MCC/MNC**■ Selection Method**

Description	Select the MCC/MNC configuration method for the APN.
Settings	<ul style="list-style-type: none"> • Automatic • Manual

■ MCC

Description	Set the APN MCC.
Settings	0 - 999

■ MNC

Description	Set the APN MNC.
Settings	0 - 999

6.1.2 PIN Code Settings**6.1.2.1 PIN**

Description	Set whether the SIM PIN is enabled.
Settings	<ul style="list-style-type: none"> • Enable • Disable

6.1.2.2 Code

Description	Enter the PIN set to the SIM.
Settings	0000 - 99999999

6.2 Telephone Entry Settings

Register a phone number for a phone, or confirm registered phone numbers for phones, passwords, or one-time passwords for registering a phone number, and phone numbers for IXGW-TGW within a site.

If "Association Settings" is not performed in Administrator mode, registration/confirmation cannot be performed.

Settings can be configured only after setting Phone Registration to "Enable" in ["Units / Stations \(→page 96\)"](#).

Refer to the instructions beginning in ["How to register phone numbers \(if registering using the IXG Support Tool\) \(→page 144\)"](#) and ["How to register phone numbers \(if registered by the resident\) \(→page 144\)"](#) for configuration information.

! Important

- In order to register a phone number, a SIM card that allows for communication over a mobile phone line is required for the IXGW-TGW.
- Do not register phone numbers for emergency use (such as for the police or fire department).
- For security, if door release using a phone will be enabled, enter "***Door Release Key**" so that the DTMF signal tone is not sounded. (If the door release key is "0000," enter "***0000**" here.)

The screenshot shows the 'Telephone Entry Settings' interface. At the top, there are four callout boxes with red lines pointing to specific buttons:

- Download Phone Information:** Obtain phone information from the IXGW-TGW.
- Export Registration PDF:** Output the method used to register phone numbers for units where "Export Registration PDF" has been checked, as a PDF file.
- Backup Phone Information:** Obtain phone numbers from the Gateway Adaptor for backup.
- Recover Phone Information:** Recover phone numbers that have been backed up.

Below the callouts, the interface includes a table of registered phone numbers and several input fields for 'Phone Entry Codes'.

Select	Building Number	Unit Number	Unit Name	Registered Phone Number	Status	Password	Default Password
<input type="checkbox"/>	01	0001	Residential203		No Phone Service	-	-
<input type="checkbox"/>	01	101	Residential101	*****1234	Upload required to finalize registration	Download Failed	Download Failed
<input type="checkbox"/>	01	102	Residential102		No Phone Service	Download Failed	Download Failed
<input type="checkbox"/>	01	103	Residential103		No Phone Service	Download Failed	Download Failed
<input type="checkbox"/>	01	104	Residential104		No Phone Service	Download Failed	Download Failed

Below the table, there are input fields for 'Relay Output 1' and 'Relay Output 2' under the heading 'Phone Entry Codes'.

Click "Telephone Entry Settings" in the Setting menu to obtain the following information from IXGW-TGW registered in "Gateway Selection" in Administrator mode. Any phone numbers that have been registered will be backed up.

- Registered Phone Number: Displays the phone number registered to IXGW-TGW.
 - Blank: No phone number registered.
 - Phone Number: The registered phone number.
- Status: Displays the status of obtaining the phone number from the IXGW-TGW.
 - Registration status is current.: Obtained successfully.
 - Upload required to finalize registration.: Obtained successfully. However, there is at least one phone number with settings not applied to a station.
 - Download Failed: Unable to obtain.
 - No Phone Service: Phone not set to "Enable" in "Units / Stations."
- Password: Displays the password used to perform registration when prompted by audio guidance while calling the gateway's phone number.
 - "-": "Gateway Selection" is not set.
 - Download Failed: Unable to obtain.
- Default Password: Displays the password used to perform initial registration when prompted by audio guidance while calling the gateway's phone number.
 - "-": "Gateway Selection" is not set.

- Download Failed: Unable to obtain.
- Gateway Adaptor: Displays the name of the Gateway Adaptor set as "Primary."
- Gateway Phone Number: Displays the SIM phone number used by the Gateway Adaptor.

How to register phone numbers (if registering using the IXG Support Tool)

1. Enter the phone number to register in "Registered Phone Number," in the unit it will be assigned to.

■ Registered Phone Number

Description	Register the phone number of the phone to assign.
Settings	1-16 digits

2. Enter the "Phone Entry Codes" on the upper right of the screen.

■ Relay Output 1

Description	Enter the number to release the electrical lock connected to Relay Output 1 of the calling destination station during communication with the phone. (Should be 4 characters or longer.)
Settings	1-20 digits

■ Relay Output 2

Description	Enter the number to release the electrical lock connected to Relay Output 2 of the calling destination station during communication with the phone. (Should be 4 characters or longer.)
Settings	1-20 digits

3. After configuration is complete, click **[Update]**.

4. Click **[OK]**.

How to register phone numbers (if registered by the resident)

1. Enter the "Phone Entry Codes" on the upper right of the screen.

■ Relay Output 1

Description	Enter the number to release the electrical lock connected to Relay Output 1 of the calling destination station while communicating with the phone. (Should be 4 characters or longer.)
Settings	1-20 digits

■ Relay Output 2

Description	Enter the number to release the electrical lock connected to Relay Output 2 of the calling destination station while communicating with the phone. (Should be 4 characters or longer.)
Settings	1-20 digits

2. After configuration is complete, click **[Update]**.

3. Click **[OK]**.

4. Check the "Export Registration PDF" box for the unit to register the phone number.

5. Click **[Export Registration PDF]**.
6. Click **[OK]**.
7. Select the folder to save the PDF file and click **[OK]**.
 - A file with the name "Building Number_Unit Number" will be created in the specified directory.
 - Click **[Cancel]** to return without saving the PDF file.
8. Provide the resident with the PDF file and have the resident register the phone number.

7. Paging Settings (Advanced Settings)

! Important

- Paging cannot be used with VoIP phones.

7.1 Paging Origination

Configure settings related to outgoing paging.

Move row

Up to 50 station number rows can be displayed at a time. Switch the screen as follows.

[Previous]: Display the previous 50 rows.

[Next]: Display the next 50 rows.

[Apply]: Enter the station number and click **[Apply]** to move the cursor to the row of the station number that was entered.

Building No	Unit Number	Station Name	Paging Timeout [sec]	Paging Wait Timer [sec]	Urgent Page Response	Lock Paging
01	0001	Master Station 1	30	10	Disable	Disable
02	0002	Master Station 1	30	10	Enable	Disable

■ Paging Timeout [sec]◆

Compatible type	<input type="checkbox"/> IXG-2C7(-*) <input checked="" type="checkbox"/> IXG-MK <input checked="" type="checkbox"/> IX-MV7-* <input type="checkbox"/> IXG-DM7(-*) <input type="checkbox"/> IX-DA, IX-DB <input type="checkbox"/> IX-BA, IX-BB <input type="checkbox"/> IX-DV, IX-DVF(-*) <input type="checkbox"/> IX-SSA(-*) <input type="checkbox"/> IX-EA, IX-EAU <input type="checkbox"/> IX-FA <input type="checkbox"/> IXGW-LC <input type="checkbox"/> IXGW-(T)GW <input type="checkbox"/> Intercom App <input type="checkbox"/> IX-SS-2G <input type="checkbox"/> IX-RS-* <input checked="" type="checkbox"/> IX-SOFT <input type="checkbox"/> IXW-MA <input type="checkbox"/> IX-SPMIC <input type="checkbox"/> VoIP Phone <input type="checkbox"/> IX-DVM
Description	Set the time for outgoing paging duration.
Settings	10-600 sec (by 1 sec) For IXG-MK, change the setting on the screen of the station.

■ Paging Wait Timer [sec]◆

Compatible type	<input type="checkbox"/> IXG-2C7(-*) <input checked="" type="checkbox"/> IXG-MK <input checked="" type="checkbox"/> IX-MV7-* <input type="checkbox"/> IXG-DM7(-*) <input type="checkbox"/> IX-DA, IX-DB <input type="checkbox"/> IX-BA, IX-BB <input type="checkbox"/> IX-DV, IX-DVF(-*) <input type="checkbox"/> IX-SSA(-*) <input type="checkbox"/> IX-EA, IX-EAU <input type="checkbox"/> IX-FA <input type="checkbox"/> IXGW-LC <input type="checkbox"/> IXGW-(T)GW <input type="checkbox"/> Intercom App <input type="checkbox"/> IX-SS-2G <input type="checkbox"/> IX-RS-* <input checked="" type="checkbox"/> IX-SOFT <input type="checkbox"/> IXW-MA <input type="checkbox"/> IX-SPMIC <input type="checkbox"/> VoIP Phone <input type="checkbox"/> IX-DVM
Description	Set the time to wait for a response from all destination stations when a page is sent. Paging will start once the set time elapses, even if there are stations for which no response was received.
Settings	1-20 sec (by 1 sec)

! Important

- A page may not be sent to a station if a response is received after "Paging Wait Timer [sec]" elapses. If there are many destination stations, configure a longer paging wait timer.

■ Urgent Page Response

Compatible type	<input type="checkbox"/> IXG-2C7(-*) <input checked="" type="checkbox"/> IXG-MK <input checked="" type="checkbox"/> IX-MV7-* <input type="checkbox"/> IXG-DM7(-*) <input type="checkbox"/> IX-DA, IX-DB <input type="checkbox"/> IX-BA, IX-BB <input type="checkbox"/> IX-DV, IX-DVF(-*) <input type="checkbox"/> IX-SSA(-*) <input type="checkbox"/> IX-EA, IX-EAU <input type="checkbox"/> IX-FA <input type="checkbox"/> IXGW-LC <input type="checkbox"/> IXGW-(T)GW <input type="checkbox"/> Intercom App <input type="checkbox"/> IX-SS-2G <input type="checkbox"/> IX-RS-* <input checked="" type="checkbox"/> IX-SOFT <input type="checkbox"/> IXW-MA <input type="checkbox"/> IX-SPMIC <input type="checkbox"/> VoIP Phone <input type="checkbox"/> IX-DVM
Description	Select Enable / Disable for the paging destination station can answer the urgent page.
Settings	<ul style="list-style-type: none"> • Enable • Disable For IXG-MK, change the setting on the screen of the station.

■ Lock Paging

Compatible type	<input type="checkbox"/> IXG-2C7(-*) <input checked="" type="checkbox"/> IXG-MK <input checked="" type="checkbox"/> IX-MV7-* <input type="checkbox"/> IXG-DM7(-*) <input type="checkbox"/> IX-DA, IX-DB <input type="checkbox"/> IX-BA, IX-BB <input type="checkbox"/> IX-DV, IX-DVF(-*) <input type="checkbox"/> IX-SSA(-*) <input type="checkbox"/> IX-EA, IX-EAU <input type="checkbox"/> IX-FA <input type="checkbox"/> IXGW-LC <input type="checkbox"/> IXGW-(T)GW <input type="checkbox"/> Intercom App <input type="checkbox"/> IX-SS-2G <input type="checkbox"/> IX-RS-* <input checked="" type="checkbox"/> IX-SOFT <input type="checkbox"/> IXW-MA <input type="checkbox"/> IX-SPMIC <input type="checkbox"/> VoIP Phone <input type="checkbox"/> IX-DVM
Description	Select Enable / Disable to lock paging function.
Settings	<ul style="list-style-type: none"> • Enable: Do not display the "PAGE" button on the main screen. • Disable



Note

- Configure the announcement tone when a page is received in "Paging" - "[Paging Pretone \(→page 183\)](#)".

7.2 All Page

Compatible type	<input type="checkbox"/> IXG-2C7(-*) <input checked="" type="checkbox"/> IXG-MK <input checked="" type="checkbox"/> IX-MV7-* <input type="checkbox"/> IXG-DM7(-*) <input type="checkbox"/> IX-DA, IX-DB <input type="checkbox"/> IX-BA, IX-BB <input type="checkbox"/> IX-DV, IX-DVF(-*) <input type="checkbox"/> IX-SSA(-*) <input type="checkbox"/> IX-EA, IX-EAU <input type="checkbox"/> IX-FA <input type="checkbox"/> IXGW-LC <input type="checkbox"/> IXGW-(T)GW <input type="checkbox"/> Intercom App <input type="checkbox"/> IX-SS-2G <input type="checkbox"/> IX-RS-* <input checked="" type="checkbox"/> IX-SOFT <input type="checkbox"/> IXW-MA <input type="checkbox"/> IX-SPMIC <input type="checkbox"/> VoIP Phone <input type="checkbox"/> IX-DVM
-----------------	---

When sending an all page, it is sent via multicast by default. Configure the setting to send via unicast.

Move row

Up to 50 station number rows can be displayed at a time.
 Switch the screen as follows.
[Previous]: Display the previous 50 rows.
[Next]: Display the next 50 rows.
[Apply]: Enter the station number and click **[Apply]** to move the cursor to the row of the station number that was entered.

Move column

Up to 50 station number columns can be displayed at a time.
 Switch the screen as follows.
[Previous]: Display the previous 50 columns.
[Next]: Display the next 50 columns.
[Apply]: Enter the station number and click **[Apply]** to move the cursor to the column of the station number that was entered.

Row Previous Next

Enter Station Number Apply

Column Previous Next

Enter Station Number Apply

Building Number	Unit Number	Station Name	Total		Paging Settings	
			Total	Unicast	All Page	Unicast
					Select Station	Building Number / Unit Number / Station Number / Station Name / Station Type
01	0001	Master Station1	2	1	Select Station	01 / 001 / 010010 / Entrance Station1 / IXG-DM7(-*)
01	201	Guard Station1	13	3	Select Station	01 / 001 / 010011 / Entrance Station2 / IXG-DM7(-*)
...	5	3	Select Station	

List of IX-MV7-*, IXG-MK, IX-SOFT in setting data

! Important

- Unicast can reach up to 50 stations. If more than 50 stations are to be paged at once, use multicast.
- It may take some time for paging to begin when paging multiple stations using Unicast.
- If sending by multicast, be sure to configure "Multicast Address" in Administrator mode.
- Paging to Door Stations other than Door Stations in your room is not possible. However, paging to Outside Area Door Stations is possible.

How to configure all page

1. Search for the station to configure from the "List of IX-MV7-*, IXG-MK, IX-SOFT in setting data."
2. Click "Select Station."

IXG Support Tool - [Select Stations]

Select Stations

Max. 500 stations can select.
 Select Station. (0/500)
 Select Unicast. (0/50)

Select		Building Number	Unit Number	Station Number	Station Name	Station Type
Select Station	Unicast					
<input checked="" type="checkbox"/>	-	01	001	010010	Entrance Station1	IXG-DM7(-*)
<input type="checkbox"/>	-	01	001	010011	Entrance Station2	IXG-DM7(-*)
<input type="checkbox"/>	-	01	444	014440	Guard Station1	IXG-MK
<input type="checkbox"/>	-	01	4444	0144440	Entrance Station1	IXG-DM7(-*)
<input type="checkbox"/>	-	01	4444	0144441	Entrance Station2	IXG-DM7(-*)

Select Station by Type:
 All

3. Check the "Select Station" cell of a station to use All Page.
 - To select or unselect all stations at once, click **[Select]** or **[Unselect]**. If all stations are selected at once, only the first 9999 stations are selected for IXG-MK, and only the first 500 stations are selected for IX-MV7-* and IX-SOFT.
4. Check the "Unicast" box next to the station to which to send a unicast message.
 - Unchecked: Multicast transmission
 - Checked: Unicast transmission
 - All are set to "Unchecked" (multicast transmission) by default.
5. Click **[OK]**.
 - Click **[Cancel]** to cancel selecting multiple stations.
6. After configuration is complete, click **[Update]**.
7. Click **[OK]**.



Note

- If the following settings are configured, up to 500 stations can be registered as paging destinations.
 - "Speed Dials" - "[Function \(→page 236\)](#)" is set to "All Page" and "Recorded Page" is set to "Disable"
 - "Option Input" - "Function" is set to "Paging" or "External Input Page" in Administrator mode, and "Option Input Page" - "[Destination \(→page 154\)](#)" is set to "All Page" and "Recorded Page" is set to "Disable"

7.3 Building Page

Compatible type	<input type="checkbox"/> IXG-2C7(-*) <input checked="" type="checkbox"/> IXG-MK <input type="checkbox"/> IX-MV7-* <input type="checkbox"/> IXG-DM7(-*) <input type="checkbox"/> IX-DA, IX-DB <input type="checkbox"/> IX-BA, IX-BB <input type="checkbox"/> IX-DV, IX-DVF(-*) <input type="checkbox"/> IX-SSA(-*) <input type="checkbox"/> IX-EA, IX-EAU <input type="checkbox"/> IX-FA <input type="checkbox"/> IXGW-LC <input type="checkbox"/> IXGW-(T)GW <input type="checkbox"/> Intercom App <input type="checkbox"/> IX-SS-2G <input type="checkbox"/> IX-RS-* <input type="checkbox"/> IX-SOFT <input type="checkbox"/> IXW-MA <input type="checkbox"/> IX-SPMIC <input type="checkbox"/> VoIP Phone <input type="checkbox"/> IX-DVM
-----------------	---

A Building Page is sent via multicast by default. Configure the setting to send via unicast.

Move row

Up to 50 station number rows can be displayed at a time. Switch the screen as follows.

[Previous]: Display the previous 50 rows.

[Next]: Display the next 50 rows.

[Apply]: Enter the station number and click **[Apply]** to move the cursor to the row of the station number that was entered.

Move column

Up to 50 station number columns can be displayed at a time. Switch the screen as follows.

[Previous]: Display the previous 50 columns.

[Next]: Display the next 50 columns.

[Apply]: Enter the station number and click **[Apply]** to move the cursor to the column of the station number that was entered.

1 Select Building

Displays settings for the selected building.

The screenshot shows the 'Building Page' interface. At the top, there are two control panels: 'Row' and 'Column'. Each panel has 'Previous' and 'Next' buttons, an input field for 'Enter Station Number', and an 'Apply' button. To the right of these panels is a 'Select Building' dropdown menu currently showing '01/Building1'. Below these controls is a table with columns for 'Building Number', 'Unit Number', 'Station Name', 'Total', and 'Unicast'. The table contains three rows of data. A red dashed arrow points from the 'Station Name' column of the second row to the 'Select Station' button in the 'Unicast' column. A red box highlights the 'Select Station' buttons in the 'Unicast' column. A yellow box highlights the 'Select Building' dropdown and the 'List of stations in station list' area.

3 List of IXG-MK in setting data

! Important

- Unicast can reach up to 50 stations. If more than 50 stations are to be paged via Building Page, configure transmission over multicast.
- It may take some time to Begin Broadcast when Paging multiple stations using Unicast.
- If sending by multicast, be sure to configure "Multicast Address" in Administrator mode.
- Paging to Door Stations other than Door Stations in your room is not possible. However, paging to Outside Area Door Stations is possible.

How to configure Building Page

1. Select the building to configure from "Select Building."
 - The Settings screen for the selected building is displayed.
2. Search for the station to be configured from "List of IXG-MK in setting data."
3. Click "Select Station" for the station to configure.

IXG Support Tool - [Select Stations]

Select Stations

Max. 500 stations can select.
 Select Station. (0/500)
 Select Unicast. (0/50)

Station List						
Select	Unicast	Building Number	Unit Number	Station Number	Station Name	Station Type
<input type="checkbox"/>	-	01	001	010010	Entrance Station1	IXG-DM7(-*)
<input type="checkbox"/>	-	01	001	010011	Entrance Station2	IXG-DM7(-*)
<input type="checkbox"/>	-	01	444	014440	Guard Station1	IXG-MK
<input type="checkbox"/>	-	01	4444	0144440	Entrance Station1	IXG-DM7(-*)
<input type="checkbox"/>	-	01	4444	0144441	Entrance Station2	IXG-DM7(-*)

Select Station by Type.
 All

4. Check the "Select Station" cell of a station to use Building Page.
 - To select or unselect all stations at once, click **[Select]** or **[Unselect]**. If all stations are selected at once, only the first 9999 stations are selected for IXG-MK, and only the first 500 stations are selected for IX-MV7-* and IX-SOFT.
5. Check the "Unicast" box next to the station to which to send a unicast message.
 - Unchecked: Multicast transmission
 - Checked: Unicast transmission
 - All are set to "Unchecked" (multicast transmission) by default.
6. Click **[OK]**.
 - Click **[Cancel]** to cancel selecting multiple stations.
7. After configuration is complete, click **[Update]**.
8. Click **[OK]**.



Note

- If IXG-MK is configured as follows, up to 500 stations can be registered as paging destinations.
 - "Speed Dials" - "[Function \(→page 236\)](#)" is set to "Building Page" and "Recorded Page" is set to "Disable"
 - "Option Input" - "Function" is set to "Paging" or "External Input Page" in Administrator mode, and "Option Input Page" - "[Destination \(→page 154\)](#)" is set to "Building" and "Recorded Page" is set to "Disable"

7.4 Option Input Page

Configure option input paging.

Configure this if "Paging", "Message Page," or "External Input Page" was selected in "Option Input" - "Function" in Administrator mode.

Move row
 Up to 50 station number rows can be displayed at a time. Switch the screen as follows.
[Previous]: Display the previous 50 rows.
[Next]: Display the next 50 rows.
[Apply]: Enter the station number and click **[Apply]** to move the cursor to the row of the station number that was entered.

Display settings
 Displays settings for the selected contact input number.

The screenshot shows a control panel with a 'Row' section containing 'Previous', 'Next', and 'Apply' buttons, and a 'Display settings' dropdown menu. Below this is a table with columns for Building Number, Unit Number, Station Name, and various paging settings.

Building Number	Unit Number	Station Name	Paging Settings								
			Destination	Recorded Page	Group		Building Number / Building Name	Priority	Message File Name	Ringback Tone Count [time(s)]	
01	0001	Master Station 1			Number	Open					
01	201	Guard Station 1	All Page	Disable		Open			Normal		

Destination

Compatible type	<input type="checkbox"/> IXG-2C7(-*) <input checked="" type="checkbox"/> IXG-MK <input checked="" type="checkbox"/> IX-MV7-* <input type="checkbox"/> IXG-DM7(-*) <input type="checkbox"/> IX-DA, IX-DB <input type="checkbox"/> IX-BA, IX-BB <input type="checkbox"/> IX-DV, IX-DVF(-*) <input type="checkbox"/> IX-SSA(-*) <input type="checkbox"/> IX-EA, IX-EAU <input type="checkbox"/> IX-FA <input type="checkbox"/> IXGW-LC <input type="checkbox"/> IXGW-(T)GW <input type="checkbox"/> Intercom App <input type="checkbox"/> IX-SS-2G <input type="checkbox"/> IX-RS-* <input type="checkbox"/> IX-SOFT <input type="checkbox"/> IXW-MA <input type="checkbox"/> IX-SPMIC <input type="checkbox"/> VoIP Phone <input type="checkbox"/> IX-DVM
Description	Set the destination group for paging.
Settings	<ul style="list-style-type: none"> All Page: Page all stations configured in "All Page (→page 148)". Building (IXG-MK only): Page the building configured in "Building Number / Building Name." Group (IX-MV7-* only): Page the group configured in "Number."

Recorded Page

Compatible type	<input type="checkbox"/> IXG-2C7(-*) <input checked="" type="checkbox"/> IXG-MK <input type="checkbox"/> IX-MV7-* <input type="checkbox"/> IXG-DM7(-*) <input type="checkbox"/> IX-DA, IX-DB <input type="checkbox"/> IX-BA, IX-BB <input type="checkbox"/> IX-DV, IX-DVF(-*) <input type="checkbox"/> IX-SSA(-*) <input type="checkbox"/> IX-EA, IX-EAU <input type="checkbox"/> IX-FA <input type="checkbox"/> IXGW-LC <input type="checkbox"/> IXGW-(T)GW <input type="checkbox"/> Intercom App <input type="checkbox"/> IX-SS-2G <input type="checkbox"/> IX-RS-* <input type="checkbox"/> IX-SOFT <input type="checkbox"/> IXW-MA <input type="checkbox"/> IX-SPMIC <input type="checkbox"/> VoIP Phone <input type="checkbox"/> IX-DVM
Description	Send a page using audio recorded prior to paging.
Settings	<ul style="list-style-type: none"> Enable Disable If there are 501 or more paging destination stations, this will be set to "Enable" and cannot be changed.

■ Number

Compatible type	<input type="checkbox"/> IXG-2C7(-*) <input type="checkbox"/> IXG-MK <input checked="" type="checkbox"/> IX-MV7-* <input type="checkbox"/> IXG-DM7(-*) <input type="checkbox"/> IX-DA, IX-DB <input type="checkbox"/> IX-BA, IX-BB <input type="checkbox"/> IX-DV, IX-DVF(-*) <input type="checkbox"/> IX-SSA(-*) <input type="checkbox"/> IX-EA, IX-EAU <input type="checkbox"/> IX-FA <input type="checkbox"/> IXGW-LC <input type="checkbox"/> IXGW-(T)GW <input type="checkbox"/> Intercom App <input type="checkbox"/> IX-SS-2G <input type="checkbox"/> IX-RS-* <input type="checkbox"/> IX-SOFT <input type="checkbox"/> IXW-MA <input type="checkbox"/> IX-SPMIC <input type="checkbox"/> VoIP Phone <input type="checkbox"/> IX-DVM
Description	Set the destination group for paging. Enter the group number manually, or click [Open] to select a group.
Settings	01-99

■ Building Number / Building Name

Compatible type	<input type="checkbox"/> IXG-2C7(-*) <input checked="" type="checkbox"/> IXG-MK <input type="checkbox"/> IX-MV7-* <input type="checkbox"/> IXG-DM7(-*) <input type="checkbox"/> IX-DA, IX-DB <input type="checkbox"/> IX-BA, IX-BB <input type="checkbox"/> IX-DV, IX-DVF(-*) <input type="checkbox"/> IX-SSA(-*) <input type="checkbox"/> IX-EA, IX-EAU <input type="checkbox"/> IX-FA <input type="checkbox"/> IXGW-LC <input type="checkbox"/> IXGW-(T)GW <input type="checkbox"/> Intercom App <input type="checkbox"/> IX-SS-2G <input type="checkbox"/> IX-RS-* <input type="checkbox"/> IX-SOFT <input type="checkbox"/> IXW-MA <input type="checkbox"/> IX-SPMIC <input type="checkbox"/> VoIP Phone <input type="checkbox"/> IX-DVM
Description	Configure the Building Number / Building Name of the paging recipient.
Settings	01/Building 1 - 99/Building 99 Select from buildings registered in "Building Information" in Administrator mode.

■ Priority

Compatible type	<input type="checkbox"/> IXG-2C7(-*) <input checked="" type="checkbox"/> IXG-MK <input checked="" type="checkbox"/> IX-MV7-* <input type="checkbox"/> IXG-DM7(-*) <input type="checkbox"/> IX-DA, IX-DB <input type="checkbox"/> IX-BA, IX-BB <input type="checkbox"/> IX-DV, IX-DVF(-*) <input type="checkbox"/> IX-SSA(-*) <input type="checkbox"/> IX-EA, IX-EAU <input type="checkbox"/> IX-FA <input type="checkbox"/> IXGW-LC <input type="checkbox"/> IXGW-(T)GW <input type="checkbox"/> Intercom App <input type="checkbox"/> IX-SS-2G <input type="checkbox"/> IX-RS-* <input type="checkbox"/> IX-SOFT <input type="checkbox"/> IXW-MA <input type="checkbox"/> IX-SPMIC <input type="checkbox"/> VoIP Phone <input type="checkbox"/> IX-DVM
Description	Configure the paging priority.
Settings	<ul style="list-style-type: none"> • Normal • Urgent

■ Message File Name

Compatible type	<input type="checkbox"/> IXG-2C7(-*) <input checked="" type="checkbox"/> IXG-MK <input checked="" type="checkbox"/> IX-MV7-* <input type="checkbox"/> IXG-DM7(-*) <input type="checkbox"/> IX-DA, IX-DB <input type="checkbox"/> IX-BA, IX-BB <input type="checkbox"/> IX-DV, IX-DVF(-*) <input type="checkbox"/> IX-SSA(-*) <input type="checkbox"/> IX-EA, IX-EAU <input type="checkbox"/> IX-FA <input type="checkbox"/> IXGW-LC <input type="checkbox"/> IXGW-(T)GW <input type="checkbox"/> Intercom App <input type="checkbox"/> IX-SS-2G <input type="checkbox"/> IX-RS-* <input type="checkbox"/> IX-SOFT <input type="checkbox"/> IXW-MA <input type="checkbox"/> IX-SPMIC <input type="checkbox"/> VoIP Phone <input type="checkbox"/> IX-DVM
Description	If "Message Page" was selected for "Option Input" - "Function" in Administrator mode, configure the audio file for the message to send.
Settings	<ul style="list-style-type: none"> • None • Call Pattern 1 • Call Pattern 2 • Call Pattern 3 • Call Pattern 4 • Call Pattern 5 • Call Pattern 6 • Tremolo Sound • Busy Response Tone • On Hold • Operation Sound • Error • Pre Tone 1 • Pre Tone 2 • Pre Tone 3 • Communication End Pretone • Call Queue Notification • Waiting Reply Tone • Select a sound that is registered in "Custom Sound Registry (→page 117)".

■ Ringback Tone Count [time(s)]

Compatible type	<input type="checkbox"/> IXG-2C7(-*) <input checked="" type="checkbox"/> IXG-MK <input checked="" type="checkbox"/> IX-MV7-* <input type="checkbox"/> IXG-DM7(-*) <input type="checkbox"/> IX-DA, IX-DB <input type="checkbox"/> IX-BA, IX-BB <input type="checkbox"/> IX-DV, IX-DVF(-*) <input type="checkbox"/> IX-SSA(-*) <input type="checkbox"/> IX-EA, IX-EAU <input type="checkbox"/> IX-FA <input type="checkbox"/> IXGW-LC <input type="checkbox"/> IXGW-(T)GW <input type="checkbox"/> Intercom App <input type="checkbox"/> IX-SS-2G <input type="checkbox"/> IX-RS-* <input type="checkbox"/> IX-SOFT <input type="checkbox"/> IXW-MA <input type="checkbox"/> IX-SPMIC <input type="checkbox"/> VoIP Phone <input type="checkbox"/> IX-DVM
Description	Configure the number of times to play the message configured for the "Message File Name."
Settings	1 - 20 times

8. Entrance Station Settings (Advanced Settings)

8.1 Display

■ Door Release Keypad

Compatible type	<input type="checkbox"/> IXG-2C7(-*) <input type="checkbox"/> IXG-MK <input type="checkbox"/> IX-MV7-* <input checked="" type="checkbox"/> IXG-DM7(-*) <input type="checkbox"/> IX-DA, IX-DB <input type="checkbox"/> IX-BA, IX-BB <input type="checkbox"/> IX-DV, IX-DVF(-*) <input type="checkbox"/> IX-SSA(-*) <input type="checkbox"/> IX-EA, IX-EAU <input type="checkbox"/> IX-FA <input type="checkbox"/> IXGW-LC <input type="checkbox"/> IXGW-(T)GW <input type="checkbox"/> Intercom App <input type="checkbox"/> IX-SS-2G <input type="checkbox"/> IX-RS-* <input type="checkbox"/> IX-SOFT <input type="checkbox"/> IXW-MA <input type="checkbox"/> IX-SPMIC <input type="checkbox"/> VoIP Phone <input type="checkbox"/> IX-DVM
Description	Configure whether to use the keypad door release function. Door Release Keypad: Release the door by entering the access code.
Settings	<ul style="list-style-type: none"> • Enable • Disable

■ Door Release QR Code

Compatible type	<input type="checkbox"/> IXG-2C7(-*) <input type="checkbox"/> IXG-MK <input type="checkbox"/> IX-MV7-* <input checked="" type="checkbox"/> IXG-DM7(-*) <input type="checkbox"/> IX-DA, IX-DB <input type="checkbox"/> IX-BA, IX-BB <input type="checkbox"/> IX-DV, IX-DVF(-*) <input type="checkbox"/> IX-SSA(-*) <input type="checkbox"/> IX-EA, IX-EAU <input type="checkbox"/> IX-FA <input type="checkbox"/> IXGW-LC <input type="checkbox"/> IXGW-(T)GW <input type="checkbox"/> Intercom App <input type="checkbox"/> IX-SS-2G <input type="checkbox"/> IX-RS-* <input type="checkbox"/> IX-SOFT <input type="checkbox"/> IXW-MA <input type="checkbox"/> IX-SPMIC <input type="checkbox"/> VoIP Phone <input type="checkbox"/> IX-DVM
Description	Configure whether to use the QR code authentication door release function. Door Release QR Code: Release the door by scanning the QR code with the IXG-DM7(-*) camera.
Settings	<ul style="list-style-type: none"> • Enable • Disable

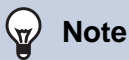

Note

- If the "Door Release QR Code" setting is changed, the station will restart once the setting is applied.
- Door release using a QR code may not be possible during network or cloud server outages. It is recommended to also use another door release method.

■ Call by Unit Number

Compatible type	<input type="checkbox"/> IXG-2C7(-*) <input type="checkbox"/> IXG-MK <input type="checkbox"/> IX-MV7-* <input checked="" type="checkbox"/> IXG-DM7(-*) <input type="checkbox"/> IX-DA, IX-DB <input type="checkbox"/> IX-BA, IX-BB <input type="checkbox"/> IX-DV, IX-DVF(-*) <input type="checkbox"/> IX-SSA(-*) <input type="checkbox"/> IX-EA, IX-EAU <input type="checkbox"/> IX-FA <input type="checkbox"/> IXGW-LC <input type="checkbox"/> IXGW-(T)GW <input type="checkbox"/> Intercom App <input type="checkbox"/> IX-SS-2G <input type="checkbox"/> IX-RS-* <input type="checkbox"/> IX-SOFT <input type="checkbox"/> IXW-MA <input type="checkbox"/> IX-SPMIC <input type="checkbox"/> VoIP Phone <input type="checkbox"/> IX-DVM
Description	Configure whether to use Call by Unit Number function. Call by Unit Number: The person to visit can be called by entering the unit number.
Settings	<ul style="list-style-type: none"> • Enable • Disable

■ Call by List

Compatible type	<input type="checkbox"/> IXG-2C7(-*) <input type="checkbox"/> IXG-MK <input type="checkbox"/> IX-MV7-* <input checked="" type="checkbox"/> IXG-DM7(-*) <input type="checkbox"/> IX-DA, IX-DB <input type="checkbox"/> IX-BA, IX-BB <input type="checkbox"/> IX-DV, IX-DVF(-*) <input type="checkbox"/> IX-SSA(-*) <input type="checkbox"/> IX-EA, IX-EAU <input type="checkbox"/> IX-FA <input type="checkbox"/> IXGW-LC <input type="checkbox"/> IXGW-(T)GW <input type="checkbox"/> Intercom App <input type="checkbox"/> IX-SS-2G <input type="checkbox"/> IX-RS-* <input type="checkbox"/> IX-SOFT <input type="checkbox"/> IXW-MA <input type="checkbox"/> IX-SPMIC <input type="checkbox"/> VoIP Phone <input type="checkbox"/> IX-DVM
Description	Configure whether to use Call by List function. Call by List: The person to visit can be called by selecting them from the Direct Call List.
Settings	<ul style="list-style-type: none"> • Enable • Disable If "[Call Directory]" was set to "Enable," the call by list function cannot be set to "Enable."

■ Search by Name

Compatible type	<input type="checkbox"/> IXG-2C7(-*) <input type="checkbox"/> IXG-MK <input type="checkbox"/> IX-MV7-* <input checked="" type="checkbox"/> IXG-DM7(-*) <input type="checkbox"/> IX-DA, IX-DB <input type="checkbox"/> IX-BA, IX-BB <input type="checkbox"/> IX-DV, IX-DVF(-*) <input type="checkbox"/> IX-SSA(-*) <input type="checkbox"/> IX-EA, IX-EAU <input type="checkbox"/> IX-FA <input type="checkbox"/> IXGW-LC <input type="checkbox"/> IXGW-(T)GW <input type="checkbox"/> Intercom App <input type="checkbox"/> IX-SS-2G <input type="checkbox"/> IX-RS-* <input type="checkbox"/> IX-SOFT <input type="checkbox"/> IXW-MA <input type="checkbox"/> IX-SPMIC <input type="checkbox"/> VoIP Phone <input type="checkbox"/> IX-DVM
Description	Configure whether to use Search by Name function. Search by Name: The person to visit can be called by searching for them using the keyboard and selecting them from the search results.
Settings	<ul style="list-style-type: none"> • Enable • Disable If " Language (→page 91) " is set to " 日本語 ," " 繁體中文 ," or " 简体中文 ," this will be set to "Disable" and cannot be changed.

■ Call Directory

Compatible type	<input type="checkbox"/> IXG-2C7(-*) <input type="checkbox"/> IXG-MK <input type="checkbox"/> IX-MV7-* <input checked="" type="checkbox"/> IXG-DM7(-*) <input type="checkbox"/> IX-DA, IX-DB <input type="checkbox"/> IX-BA, IX-BB <input type="checkbox"/> IX-DV, IX-DVF(-*) <input type="checkbox"/> IX-SSA(-*) <input type="checkbox"/> IX-EA, IX-EAU <input type="checkbox"/> IX-FA <input type="checkbox"/> IXGW-LC <input type="checkbox"/> IXGW-(T)GW <input type="checkbox"/> Intercom App <input type="checkbox"/> IX-SS-2G <input type="checkbox"/> IX-RS-* <input type="checkbox"/> IX-SOFT <input type="checkbox"/> IXW-MA <input type="checkbox"/> IX-SPMIC <input type="checkbox"/> VoIP Phone <input type="checkbox"/> IX-DVM
Description	Configure whether to use the call directory function. Call Directory: The desired tenant can be called by selecting them from their directory.
Settings	<ul style="list-style-type: none"> • Enable • Disable If "[Call by List]" is set to "Enable," the call directory function cannot be set to "Enable."

■ Display Call by Directory thumbnails

Compatible type	<input type="checkbox"/> IXG-2C7(-*) <input type="checkbox"/> IXG-MK <input type="checkbox"/> IX-MV7-* <input checked="" type="checkbox"/> IXG-DM7(-*) <input type="checkbox"/> IX-DA, IX-DB <input type="checkbox"/> IX-BA, IX-BB <input type="checkbox"/> IX-DV, IX-DVF(-*) <input type="checkbox"/> IX-SSA(-*) <input type="checkbox"/> IX-EA, IX-EAU <input type="checkbox"/> IX-FA <input type="checkbox"/> IXGW-LC <input type="checkbox"/> IXGW-(T)GW <input type="checkbox"/> Intercom App <input type="checkbox"/> IX-SS-2G <input type="checkbox"/> IX-RS-* <input type="checkbox"/> IX-SOFT <input type="checkbox"/> IXW-MA <input type="checkbox"/> IX-SPMIC <input type="checkbox"/> VoIP Phone <input type="checkbox"/> IX-DVM
Description	If " Call Directory (→page 158) " was set to "Enable," configure whether to display call by directory thumbnails.
Settings	<ul style="list-style-type: none"> • Enable • Disable

■ Default Display Screen

Compatible type	<input type="checkbox"/> IXG-2C7(-*) <input type="checkbox"/> IXG-MK <input type="checkbox"/> IX-MV7-* <input checked="" type="checkbox"/> IXG-DM7(-*) <input type="checkbox"/> IX-DA, IX-DB <input type="checkbox"/> IX-BA, IX-BB <input type="checkbox"/> IX-DV, IX-DVF(-*) <input type="checkbox"/> IX-SSA(-*) <input type="checkbox"/> IX-EA, IX-EAU <input type="checkbox"/> IX-FA <input type="checkbox"/> IXGW-LC <input type="checkbox"/> IXGW-(T)GW <input type="checkbox"/> Intercom App <input type="checkbox"/> IX-SS-2G <input type="checkbox"/> IX-RS-* <input type="checkbox"/> IX-SOFT <input type="checkbox"/> IXW-MA <input type="checkbox"/> IX-SPMIC <input type="checkbox"/> VoIP Phone <input type="checkbox"/> IX-DVM
Description	Configure the first operation screen displayed when calling a person to visit.
Settings	Select from the function screens for which “Door Release Keypad (→page 157)” , “Door Release QR Code (→page 157)” , “Call by Unit Number (→page 157)” , “Call by List (→page 158)” , “Search by Name (→page 158)” , or “Call Directory (→page 158)” has been set to "Enable." <ul style="list-style-type: none"> • Door Release Keypad • Search by List Screen • Search by Name Screen • Call by Directory • Call by Unit Number Screen • Door Release QR Code

■ Building Selection Button

Compatible type	<input type="checkbox"/> IXG-2C7(-*) <input type="checkbox"/> IXG-MK <input type="checkbox"/> IX-MV7-* <input checked="" type="checkbox"/> IXG-DM7(-*) <input type="checkbox"/> IX-DA, IX-DB <input type="checkbox"/> IX-BA, IX-BB <input type="checkbox"/> IX-DV, IX-DVF(-*) <input type="checkbox"/> IX-SSA(-*) <input type="checkbox"/> IX-EA, IX-EAU <input type="checkbox"/> IX-FA <input type="checkbox"/> IXGW-LC <input type="checkbox"/> IXGW-(T)GW <input type="checkbox"/> Intercom App <input type="checkbox"/> IX-SS-2G <input type="checkbox"/> IX-RS-* <input type="checkbox"/> IX-SOFT <input type="checkbox"/> IXW-MA <input type="checkbox"/> IX-SPMIC <input type="checkbox"/> VoIP Phone <input type="checkbox"/> IX-DVM
Description	Configure whether to use the Building Selection Button in a Multiple Building System. If set to "Enable," the Building Selection Button will be displayed on the Call by Unit Number Screen to allow a unit in another building to be called.
Settings	<ul style="list-style-type: none"> • Enable • Disable

■ Hearing aid Icon

Compatible type	<input type="checkbox"/> IXG-2C7(-*) <input type="checkbox"/> IXG-MK <input type="checkbox"/> IX-MV7-* <input checked="" type="checkbox"/> IXG-DM7(-*) <input type="checkbox"/> IX-DA, IX-DB <input type="checkbox"/> IX-BA, IX-BB <input type="checkbox"/> IX-DV, IX-DVF(-*) <input type="checkbox"/> IX-SSA(-*) <input type="checkbox"/> IX-EA, IX-EAU <input type="checkbox"/> IX-FA <input type="checkbox"/> IXGW-LC <input type="checkbox"/> IXGW-(T)GW <input type="checkbox"/> Intercom App <input type="checkbox"/> IX-SS-2G <input type="checkbox"/> IX-RS-* <input type="checkbox"/> IX-SOFT <input type="checkbox"/> IXW-MA <input type="checkbox"/> IX-SPMIC <input type="checkbox"/> VoIP Phone <input type="checkbox"/> IX-DVM
Description	Configure whether to display the hearing aid T-mode compatibility symbol on the screen.
Settings	<ul style="list-style-type: none"> • Enable • Disable

■ Display Video

Compatible type	<input type="checkbox"/> IXG-2C7(-*) <input type="checkbox"/> IXG-MK <input type="checkbox"/> IX-MV7-* <input checked="" type="checkbox"/> IXG-DM7(-*) <input type="checkbox"/> IX-DA, IX-DB <input type="checkbox"/> IX-BA, IX-BB <input type="checkbox"/> IX-DV, IX-DVF(-*) <input type="checkbox"/> IX-SSA(-*) <input type="checkbox"/> IX-EA, IX-EAU <input type="checkbox"/> IX-FA <input type="checkbox"/> IXGW-LC <input type="checkbox"/> IXGW-(T)GW <input type="checkbox"/> Intercom App <input type="checkbox"/> IX-SS-2G <input type="checkbox"/> IX-RS-* <input type="checkbox"/> IX-SOFT <input type="checkbox"/> IXW-MA <input type="checkbox"/> IX-SPMIC <input type="checkbox"/> VoIP Phone <input type="checkbox"/> IX-DVM
Description	Set whether to display video on the Entrance Station screen during a call/communication.
Settings	<ul style="list-style-type: none"> • Disable • Display video from built-in camera • Display video from communicating station (destination station video during calls only)

■ Language Icon

Compatible type	<input type="checkbox"/> IXG-2C7(-*) <input type="checkbox"/> IXG-MK <input type="checkbox"/> IX-MV7-* <input checked="" type="checkbox"/> IXG-DM7(-*) <input type="checkbox"/> IX-DA, IX-DB <input type="checkbox"/> IX-BA, IX-BB <input type="checkbox"/> IX-DV, IX-DVF(-*) <input type="checkbox"/> IX-SSA(-*) <input type="checkbox"/> IX-EA, IX-EAU <input type="checkbox"/> IX-FA <input type="checkbox"/> IXGW-LC <input type="checkbox"/> IXGW-(T)GW <input type="checkbox"/> Intercom App <input type="checkbox"/> IX-SS-2G <input type="checkbox"/> IX-RS-* <input type="checkbox"/> IX-SOFT <input type="checkbox"/> IXW-MA <input type="checkbox"/> IX-SPMIC <input type="checkbox"/> VoIP Phone <input type="checkbox"/> IX-DVM
Description	Configure whether to display the language button.
Settings	<ul style="list-style-type: none"> • Enable • Disable

■ Available Languages

Compatible type	<input type="checkbox"/> IXG-2C7(-*) <input type="checkbox"/> IXG-MK <input type="checkbox"/> IX-MV7-* <input checked="" type="checkbox"/> IXG-DM7(-*) <input type="checkbox"/> IX-DA, IX-DB <input type="checkbox"/> IX-BA, IX-BB <input type="checkbox"/> IX-DV, IX-DVF(-*) <input type="checkbox"/> IX-SSA(-*) <input type="checkbox"/> IX-EA, IX-EAU <input type="checkbox"/> IX-FA <input type="checkbox"/> IXGW-LC <input type="checkbox"/> IXGW-(T)GW <input type="checkbox"/> Intercom App <input type="checkbox"/> IX-SS-2G <input type="checkbox"/> IX-RS-* <input type="checkbox"/> IX-SOFT <input type="checkbox"/> IXW-MA <input type="checkbox"/> IX-SPMIC <input type="checkbox"/> VoIP Phone <input type="checkbox"/> IX-DVM
Description	Set the available language displayed by tapping the language button.
Settings	<ul style="list-style-type: none"> • Checked: Can be changed • Unchecked: Cannot be changed

8.2 Welcome Screen

An image may be set as a Welcome Screen to be displayed prior to seeing the operation screen.

Building Number	Unit Number	Station Name	Entrance Station Settings						
			Welcome Screen						
			Welcome Screen Wallpaper	Image			Delete		
Display	File name	Browse		Preview					
01	001	Entrance Station1	<input checked="" type="checkbox"/>	<input type="checkbox"/>		Browse	Preview	<input type="checkbox"/>	
01	001	Entrance Station2	<input checked="" type="checkbox"/>	<input type="checkbox"/>		Browse	Preview	<input type="checkbox"/>	
01	4444	Entrance Station1	<input checked="" type="checkbox"/>	<input type="checkbox"/>		Browse	Preview	<input type="checkbox"/>	
01	4444	Entrance Station2	<input checked="" type="checkbox"/>	<input type="checkbox"/>		Browse	Preview	<input type="checkbox"/>	

8.2.1 Welcome Screen Wallpaper

Compatible type	<input type="checkbox"/> IXG-2C7(-*) <input type="checkbox"/> IXG-MK <input type="checkbox"/> IX-MV7-* <input checked="" type="checkbox"/> IXG-DM7(-*) <input type="checkbox"/> IX-DA, IX-DB <input type="checkbox"/> IX-BA, IX-BB <input type="checkbox"/> IX-DV, IX-DVF(-*) <input type="checkbox"/> IX-SSA(-*) <input type="checkbox"/> IX-EA, IX-EAU <input type="checkbox"/> IX-FA <input type="checkbox"/> IXGW-LC <input type="checkbox"/> IXGW-(T)GW <input type="checkbox"/> Intercom App <input type="checkbox"/> IX-SS-2G <input type="checkbox"/> IX-RS-* <input type="checkbox"/> IX-SOFT <input type="checkbox"/> IXW-MA <input type="checkbox"/> IX-SPMIC <input type="checkbox"/> VoIP Phone <input type="checkbox"/> IX-DVM
Description	Configure whether to display the Welcome Screen.
Settings	<ul style="list-style-type: none"> • Checked: Enable • Unchecked: Disable

8.2.2 Image

Register the image to display if "Checked: Enable" was set in "Welcome Screen Wallpaper."
If no image is registered, the default Welcome Screen will be displayed.

■ Display

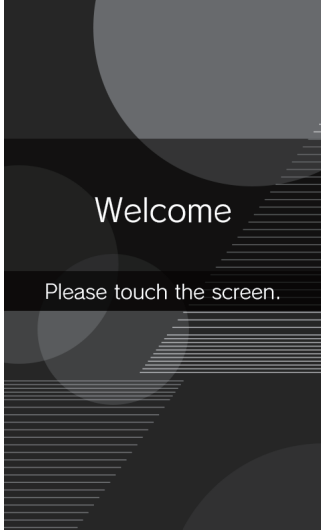
Compatible type	<input type="checkbox"/> IXG-2C7(-*) <input type="checkbox"/> IXG-MK <input type="checkbox"/> IX-MV7-* <input checked="" type="checkbox"/> IXG-DM7(-*) <input type="checkbox"/> IX-DA, IX-DB <input type="checkbox"/> IX-BA, IX-BB <input type="checkbox"/> IX-DV, IX-DVF(-*) <input type="checkbox"/> IX-SSA(-*) <input type="checkbox"/> IX-EA, IX-EAU <input type="checkbox"/> IX-FA <input type="checkbox"/> IXGW-LC <input type="checkbox"/> IXGW-(T)GW <input type="checkbox"/> Intercom App <input type="checkbox"/> IX-SS-2G <input type="checkbox"/> IX-RS-* <input type="checkbox"/> IX-SOFT <input type="checkbox"/> IXW-MA <input type="checkbox"/> IX-SPMIC <input type="checkbox"/> VoIP Phone <input type="checkbox"/> IX-DVM
Description	<p>Configure whether to display the registered image on the Welcome Screen. Only a single image file can be displayed.</p> 
Settings	<ul style="list-style-type: none"> • Checked: Use the registered image. • Unchecked: Use the default image.

■ File name

Compatible type	<input type="checkbox"/> IXG-2C7(-*) <input type="checkbox"/> IXG-MK <input type="checkbox"/> IX-MV7-* <input checked="" type="checkbox"/> IXG-DM7(-*) <input type="checkbox"/> IX-DA, IX-DB <input type="checkbox"/> IX-BA, IX-BB <input type="checkbox"/> IX-DV, IX-DVF(-*) <input type="checkbox"/> IX-SSA(-*) <input type="checkbox"/> IX-EA, IX-EAU <input type="checkbox"/> IX-FA <input type="checkbox"/> IXGW-LC <input type="checkbox"/> IXGW-(T)GW <input type="checkbox"/> Intercom App <input type="checkbox"/> IX-SS-2G <input type="checkbox"/> IX-RS-* <input type="checkbox"/> IX-SOFT <input type="checkbox"/> IXW-MA <input type="checkbox"/> IX-SPMIC <input type="checkbox"/> VoIP Phone <input type="checkbox"/> IX-DVM
Description	<p>Register an image to display on the Welcome Screen.</p> <ul style="list-style-type: none"> • File Name: Within 53 characters (excluding extension) • File format: png • Resolution: <ul style="list-style-type: none"> Width: 480 pixels Height: 800 pixels
Settings	<p>OK: Click [Browse] to select a file. Preview: Click [Preview] to check the image that was registered. Delete: Check the Delete box and then click "Update" to delete the image.</p>

8.3 Thumbnail Image

["How to register multiple thumbnail images at once \(→page 164\)"](#)

Batch Thumbnail Registration

Building Number	Unit Number	Station Name	Entrance Station Settings											
			Thumbnail Image											
			Thumbnail Image Number1				Thumbnail Image Number2				Thumbnail Image Number3			
			File name			Delete	File name			Delete	File name			Delete
01	001	Entrance Station1		Browse	Preview	<input type="checkbox"/>		Browse	Preview	<input type="checkbox"/>		Browse	Preview	<input type="checkbox"/>
01	001	Entrance Station2		Browse	Preview	<input type="checkbox"/>		Browse	Preview	<input type="checkbox"/>		Browse	Preview	<input type="checkbox"/>
01	4444	Entrance Station1		Browse	Preview	<input type="checkbox"/>		Browse	Preview	<input type="checkbox"/>		Browse	Preview	<input type="checkbox"/>
01	4444	Entrance Station2		Browse	Preview	<input type="checkbox"/>		Browse	Preview	<input type="checkbox"/>		Browse	Preview	<input type="checkbox"/>

■ File name

Compatible type	<input type="checkbox"/> IXG-2C7(-*) <input type="checkbox"/> IXG-MK <input type="checkbox"/> IX-MV7-* <input checked="" type="checkbox"/> IXG-DM7(-*) <input type="checkbox"/> IX-DA, IX-DB <input type="checkbox"/> IX-BA, IX-BB <input type="checkbox"/> IX-DV, IX-DVF(-*) <input type="checkbox"/> IX-SSA(-*) <input type="checkbox"/> IX-EA, IX-EAU <input type="checkbox"/> IX-FA <input type="checkbox"/> IXGW-LC <input type="checkbox"/> IXGW-(T)GW <input type="checkbox"/> Intercom App <input type="checkbox"/> IX-SS-2G <input type="checkbox"/> IX-RS-* <input type="checkbox"/> IX-SOFT <input type="checkbox"/> IXW-MA <input type="checkbox"/> IX-SPMIC <input type="checkbox"/> VoIP Phone <input type="checkbox"/> IX-DVM
Description	Register the images to use on the Search by List Screen and Display Call by Directory thumbnails. Up to 500 images can be registered. <ul style="list-style-type: none"> • File Name: 53 characters or less (excluding extension) • Format: png • Resolution <ul style="list-style-type: none"> Width: 80 pixels Height: 60 pixels
Settings	OK: Click [Browse] to select a file. Preview: Click [Preview] to check the image that was registered. Delete: Check the Delete box and then click "Update" to delete the image.

How to register multiple thumbnail images at once

Thumbnail images can be registered to multiple stations at once.

Click **[Batch Thumbnail Registration]** to display the following screen.

Batch Thumbnail Registration

Choose the file to be uploaded to the selected station(s).

1

Enter Thumbnail Image Number to register.

2

Select the stations that will the Thumbnail Image will be registered to.
If a station already has a thumbnail image registered to that number, it will be overwritten.

Station List				
Select	Building Nu	Unit Number	Station Name	Station Type
<input checked="" type="checkbox"/>	01	001	Entrance Station1	IXG-DM7(-*)
<input type="checkbox"/>	01	001	Entrance Station2	IXG-DM7(-*)
<input type="checkbox"/>	01	4444	Entrance Station1	IXG-DM7(-*)
<input type="checkbox"/>	01	4444	Entrance Station2	IXG-DM7(-*)

4

1. Click **[Browse]**, select the image file to register, and then click **[Open]**.
2. Enter the number of the thumbnail to register the image file.
 - 1 - 500
3. Select the station to register the image file to from "Station List." (Multiple selections allowed.)
 - To select or unselect multiple stations at once, click **[Select]** or **[Unselect]**.
4. Click **[Execute]**.
 - Click **[Cancel]** to quit without registering multiple files at once.

8.4 Direct Call List

If "Display" - "[Call by List \(→page 158\)](#)" was set to "Enable," configure the call destinations to display in the list. Up to 500 units can be configured as call destinations.

["How to copy the Direct Call List \(→page 166\)"](#)

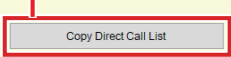

Entrance Station Settings			Direct Call List										
Building Number	Unit Number	Station Name	Display Thumbnail Image	Button Number1				Button Number2					
				Building Number	Unit Number	Select Unit	Thumbnail image options	Preview	Building Number	Unit Number	Select Unit	Thumbnail image options	Preview
01	001	Entrance Station1	<input checked="" type="checkbox"/>	01	101	Select		Preview	01	102	Select		Preview
01	001	Entrance Station2	<input type="checkbox"/>			Select		Preview			Select		Preview
01	4444	Entrance Station1	<input type="checkbox"/>			Select		Preview			Select		Preview
01	4444	Entrance Station2	<input type="checkbox"/>			Select		Preview			Select		Preview

■ Display Thumbnail Image

Compatible type	<input type="checkbox"/> IXG-2C7(-*) <input type="checkbox"/> IXG-MK <input type="checkbox"/> IX-MV7-* <input checked="" type="checkbox"/> IXG-DM7(-*) <input type="checkbox"/> IX-DA, IX-DB <input type="checkbox"/> IX-BA, IX-BB <input type="checkbox"/> IX-DV, IX-DVF(-*) <input type="checkbox"/> IX-SSA(-*) <input type="checkbox"/> IX-EA, IX-EAU <input type="checkbox"/> IX-FA <input type="checkbox"/> IXGW-LC <input type="checkbox"/> IXGW-(T)GW <input type="checkbox"/> Intercom App <input type="checkbox"/> IX-SS-2G <input type="checkbox"/> IX-RS-* <input type="checkbox"/> IX-SOFT <input type="checkbox"/> IXW-MA <input type="checkbox"/> IX-SPMIC <input type="checkbox"/> VoIP Phone <input type="checkbox"/> IX-DVM
Description	Configure whether to display thumbnail images on the Search by List Screen of the Entrance Station.
Settings	<ul style="list-style-type: none"> • Checked: Enable • Unchecked: Disable

■ Button Number 1 to 500

Compatible type	<input type="checkbox"/> IXG-2C7(-*) <input type="checkbox"/> IXG-MK <input type="checkbox"/> IX-MV7-* <input checked="" type="checkbox"/> IXG-DM7(-*) <input type="checkbox"/> IX-DA, IX-DB <input type="checkbox"/> IX-BA, IX-BB <input type="checkbox"/> IX-DV, IX-DVF(-*) <input type="checkbox"/> IX-SSA(-*) <input type="checkbox"/> IX-EA, IX-EAU <input type="checkbox"/> IX-FA <input type="checkbox"/> IXGW-LC <input type="checkbox"/> IXGW-(T)GW <input type="checkbox"/> Intercom App <input type="checkbox"/> IX-SS-2G <input type="checkbox"/> IX-RS-* <input type="checkbox"/> IX-SOFT <input type="checkbox"/> IXW-MA <input type="checkbox"/> IX-SPMIC <input type="checkbox"/> VoIP Phone <input type="checkbox"/> IX-DVM
Description	Configure the call destinations and thumbnail images to display on the Search by List Screen. To configure a call destination, click [Select] to choose one. To configure a thumbnail image, click "Thumbnail image options" and select an image. Click [Preview] to check the image that was set.
Settings	<ul style="list-style-type: none"> • Button Number: Select from the units registered in "Station List (→page 104)". • Thumbnail image options: Select from the thumbnail images registered in "Thumbnail Image (→page 163)".

How to copy the Direct Call List

Copy call destinations that have already been set to another Entrance Station.

1

2

3

4

1. Select the Entrance Station to copy.
2. Select what to copy.
3. Click **[Select]** for the destination Entrance Station to choose one.
4. Click **[Execute]**.
 - Click **[Cancel]** to stop copying.
5. Click **[OK]**.
6. Click **[OK]**.
 - Copying is now complete.

8.5 Call Directory

If "Display" - ["Call Directory \(→page 158\)"](#) was set to "Enable," configure the call destinations to display in the Call by Directory Screen.

Up to 6 directories can be registered.

Up to 500 groups and call destinations can be registered in total.

Filter

Building Number / Building Name: Select the building to display.
 Station Number / Station Name: Select the station to display and then click **[Apply]**. The call directory destinations registered to the selected station are displayed.

["How to copy a call directory \(→page 168\)"](#)

Call Directory List	Add Call Button	Add Sub Directory	Delete	Name	Building Number	Unit Number	Unit Name	Thumbnail	Preview
Top Directory	+	-	Delete						Preview
1st floor	+	-	Delete	1st floor	01	105	Residential105		Preview
			Delete		01	106	Residential106		Preview
New Group	+	-	Delete	New Group					Preview
Commercial204	+	-	Delete	Commercial204	02	0002	Commercial204		Preview
Commercial205	+	-	Delete	Commercial205	03	0003	Commercial205		Preview

How to configure

- Use "Filter" to select the Entrance Station to configure and then click **[Apply]**.
 - The Settings screen for the selected Entrance Station is displayed.
- Configure the call directory list. Click **[+]** under "Add Sub Directory" to add a call subdirectory list underneath.
- Set the Name of the call directory list that was added.
 - 1-24 alphanumeric characters
- Set the call destination unit for each call directory list. Click **[+]** under "Add Call Button" to add a unit.
- Use "Thumbnail" to set the thumbnail images for the call directory list and units. Select from the thumbnail images registered in ["Thumbnail Image \(→page 163\)"](#).
 - Click **[Preview]** to check the image that was set.



Note

- Click **[Delete]** to delete the registered call directory list or call destination.
- Deleting a group will also delete any call directory lists or call destinations under it.

How to copy a call directory

Copy call directory lists that have already been configured to another Entrance Station.

IXXG Support Tool - [Copy Call Directory]

Copy Call Directory

Copying the thumbnail will register the thumbnail image along with the thumbnail settings.

1 Copy Source Station

Building Number / Building Name
01/Building1

Station Number / Station Name
010010/Entrance Station1

2 Select item(s) to copy

Destination Units

Thumbnail Images

3 Copy Destination Station(s)

Select None Selected

4 Execute Cancel

1. Select the Entrance Station to copy.
2. Select what to copy.
3. Click **[Select]** for the destination Entrance Station to select it.
4. Click **[Execute]**.
 - Click **[Cancel]** to stop copying.
5. Click **[OK]**.
6. Click **[OK]**.
 - Copying is now complete.

8.6 Call Limitation Schedule

Configure call-restricted destinations and schedules to limit for each Entrance Station.

Move row
Up to 50 station number rows can be displayed at a time. Switch the screen as follows.
[Previous]: Display the previous 50 rows.
[Next]: Display the next 50 rows.
[Apply]: Enter the station number and click **[Apply]** to move the cursor to the row of the station number that was entered.

Display settings
[“How to perform Schedule View Adjustment \(→page 171\)”](#)

Move to Related Settings
 Moves to the selected item within the same Settings screen.

■ Call Limitation

Compatible type	<input type="checkbox"/> IXG-2C7(-*) <input type="checkbox"/> IXG-MK <input type="checkbox"/> IX-MV7-* <input checked="" type="checkbox"/> IXG-DM7(-*) <input type="checkbox"/> IX-DA, IX-DB <input type="checkbox"/> IX-BA, IX-BB <input type="checkbox"/> IX-DV, IX-DVF(-*) <input type="checkbox"/> IX-SSA(-*) <input type="checkbox"/> IX-EA, IX-EAU <input type="checkbox"/> IX-FA <input type="checkbox"/> IXGW-LC <input type="checkbox"/> IXGW-(T)GW <input type="checkbox"/> Intercom App <input type="checkbox"/> IX-SS-2G <input type="checkbox"/> IX-RS-* <input type="checkbox"/> IX-SOFT <input type="checkbox"/> IXW-MA <input type="checkbox"/> IX-SPMIC <input type="checkbox"/> VoIP Phone <input type="checkbox"/> IX-DVM
Description	Configure whether to restrict Entrance Station calls. When calls are restricted, the call restriction screen will be displayed instead of the Welcome Screen, and the call destinations will be displayed in the direct call list. Only call destinations configured in “Call Destination 1 to 6 (→page 170)” can be called.
Settings	<ul style="list-style-type: none"> • Enable • Disable

■ Display Thumbnail Image

Compatible type	<input type="checkbox"/> IXG-2C7(-*) <input type="checkbox"/> IXG-MK <input type="checkbox"/> IX-MV7-* <input checked="" type="checkbox"/> IXG-DM7(-*) <input type="checkbox"/> IX-DA, IX-DB <input type="checkbox"/> IX-BA, IX-BB <input type="checkbox"/> IX-DV, IX-DVF(-*) <input type="checkbox"/> IX-SSA(-*) <input type="checkbox"/> IX-EA, IX-EAU <input type="checkbox"/> IX-FA <input type="checkbox"/> IXGW-LC <input type="checkbox"/> IXGW-(T)GW <input type="checkbox"/> Intercom App <input type="checkbox"/> IX-SS-2G <input type="checkbox"/> IX-RS-* <input type="checkbox"/> IX-SOFT <input type="checkbox"/> IXW-MA <input type="checkbox"/> IX-SPMIC <input type="checkbox"/> VoIP Phone <input type="checkbox"/> IX-DVM
Description	Configure whether to display thumbnail images in the call-restricted destination list on the Entrance Station.
Settings	<ul style="list-style-type: none"> • Checked: Enable • Unchecked: Disable

8.6.1 Schedule Settings

Configure the call-restricted destinations and restricted times for each day of the week from Sunday through Saturday.

3 schedules can be set for each day of the week.

■ Call Destination 1 to 6

Compatible type	<input type="checkbox"/> IXG-2C7(-*) <input type="checkbox"/> IXG-MK <input type="checkbox"/> IX-MV7-* <input checked="" type="checkbox"/> IXG-DM7(-*) <input type="checkbox"/> IX-DA, IX-DB <input type="checkbox"/> IX-BA, IX-BB <input type="checkbox"/> IX-DV, IX-DVF(-*) <input type="checkbox"/> IX-SSA(-*) <input type="checkbox"/> IX-EA, IX-EAU <input type="checkbox"/> IX-FA <input type="checkbox"/> IXGW-LC <input type="checkbox"/> IXGW-(T)GW <input type="checkbox"/> Intercom App <input type="checkbox"/> IX-SS-2G <input type="checkbox"/> IX-RS-* <input type="checkbox"/> IX-SOFT <input type="checkbox"/> IXW-MA <input type="checkbox"/> IX-SPMIC <input type="checkbox"/> VoIP Phone <input type="checkbox"/> IX-DVM
Description	<p>Configure the call-restricted destinations and thumbnail images.</p> <p>Up to 6 units can be configured as call destinations. To configure a call destination, click [Select] to select one.</p> <p>To configure a thumbnail image, click "Thumbnail image options" and select the image to configure.</p> <p>Click [Preview] to check the image that was set.</p>
Settings	<ul style="list-style-type: none"> • Unit Number: Select from the units registered in "Station List (→page 104)". • Thumbnail image options: Select from the thumbnail images registered in "Thumbnail Image (→page 163)".

■ Start Time

Compatible type	<input type="checkbox"/> IXG-2C7(-*) <input type="checkbox"/> IXG-MK <input type="checkbox"/> IX-MV7-* <input checked="" type="checkbox"/> IXG-DM7(-*) <input type="checkbox"/> IX-DA, IX-DB <input type="checkbox"/> IX-BA, IX-BB <input type="checkbox"/> IX-DV, IX-DVF(-*) <input type="checkbox"/> IX-SSA(-*) <input type="checkbox"/> IX-EA, IX-EAU <input type="checkbox"/> IX-FA <input type="checkbox"/> IXGW-LC <input type="checkbox"/> IXGW-(T)GW <input type="checkbox"/> Intercom App <input type="checkbox"/> IX-SS-2G <input type="checkbox"/> IX-RS-* <input type="checkbox"/> IX-SOFT <input type="checkbox"/> IXW-MA <input type="checkbox"/> IX-SPMIC <input type="checkbox"/> VoIP Phone <input type="checkbox"/> IX-DVM
Description	Configure the time to begin restricting calls.
Settings	00:00-23:59

■ End Time

Compatible type	<input type="checkbox"/> IXG-2C7(-*) <input type="checkbox"/> IXG-MK <input type="checkbox"/> IX-MV7-* <input checked="" type="checkbox"/> IXG-DM7(-*) <input type="checkbox"/> IX-DA, IX-DB <input type="checkbox"/> IX-BA, IX-BB <input type="checkbox"/> IX-DV, IX-DVF(-*) <input type="checkbox"/> IX-SSA(-*) <input type="checkbox"/> IX-EA, IX-EAU <input type="checkbox"/> IX-FA <input type="checkbox"/> IXGW-LC <input type="checkbox"/> IXGW-(T)GW <input type="checkbox"/> Intercom App <input type="checkbox"/> IX-SS-2G <input type="checkbox"/> IX-RS-* <input type="checkbox"/> IX-SOFT <input type="checkbox"/> IXW-MA <input type="checkbox"/> IX-SPMIC <input type="checkbox"/> VoIP Phone <input type="checkbox"/> IX-DVM
Description	Configure the time to end restricting calls. If this is set earlier than "Start Time," the end time will be that time on the following day.
Settings	00:00-23:59

How to perform Schedule View Adjustment

Configure the day of the week and schedule range shown on the Settings screen.

The display can be filtered to show only the day and schedule to configure.

Click [**Schedule View Adjustment**]. The "Schedule View Adjustment" screen will be displayed.

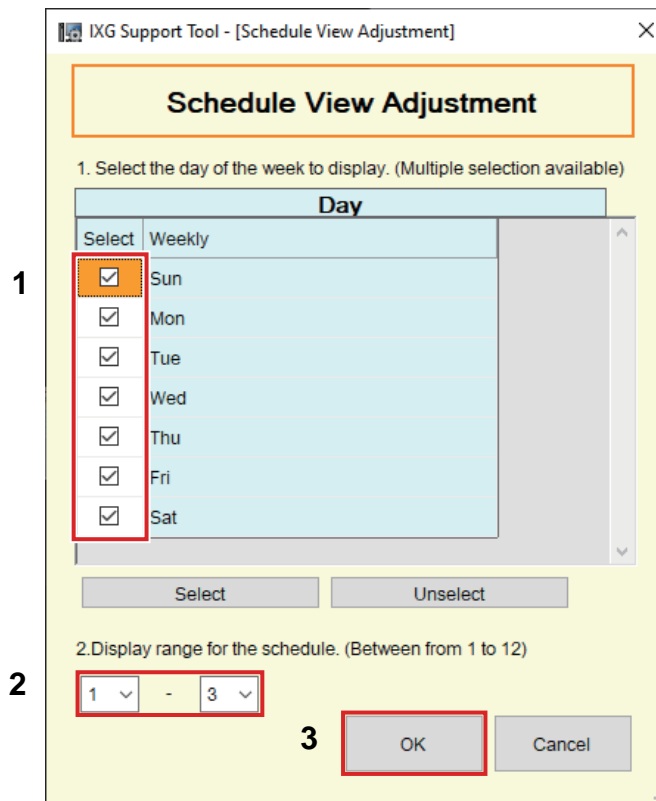

1. Select the day of week to display from "Day." (Multiple selections allowed.)
 - To select or unselect all days of the week at once, click [**Select**] or [**Unselect**].
 - By default, all days are shown.
2. Select the range of schedules to display (1 to 3) that can be configured for each day of week.
 - By default, the range of 1 - 3 is displayed.
3. Click [**OK**].
 - Click [**Cancel**] to cancel configuring the schedule display.

8.7 Access Card Registration

Configure the access cards for each unit, for each Entrance Station.
 Access cards can also be configured for 10 user groups, for each unit.
 Up to 10 card numbers can be registered for each unit and user group.

Filter
 Building Number / Building Name: Select the building to display.
 Station Number / Station Name: Select the station to display and then click **[Apply]** to display the settings of the selected station.

Card Format, Facility Code

["Access Card Batch Registration \(→page 174\)"](#)

["Copy Access Card Information to other Station\(s\) \(→page 175\)"](#)

Building Number	Unit Number / User Group	Entrance Station Settings	Access Card Registration	Card Information									
		Unit / User Group Name	Access Card Mode	Card Number 1	Card Number 2	Card Number 3	Card Number 4	Card Number 5	Card Number 6	Card Number 7	Card Number 8	Card Number 9	Card Number 10
01	001	Entrance001	Card Access Always ON	1131									
01	0001	Residential003	Card Access Always ON										
01	101	Residential101	Card Access Always ON										
01	102	Residential102	Card Access Always ON										
01	103	Residential103	Card Access Always ON										
01	104	Residential104	Card Access Always ON										
01	105	Residential105	Card Access Always ON										
01	106	Residential106	Card Access Always ON										

■ Card Format

Compatible type	<input type="checkbox"/> IXG-2C7(-*) <input type="checkbox"/> IXG-MK <input type="checkbox"/> IX-MV7-* <input checked="" type="checkbox"/> IXG-DM7(-*) <input type="checkbox"/> IX-DA, IX-DB <input type="checkbox"/> IX-BA, IX-BB <input type="checkbox"/> IX-DV, IX-DVF(-*) <input type="checkbox"/> IX-SSA(-*) <input type="checkbox"/> IX-EA, IX-EAU <input type="checkbox"/> IX-FA <input type="checkbox"/> IXGW-LC <input type="checkbox"/> IXGW-(T)GW <input type="checkbox"/> Intercom App <input type="checkbox"/> IX-SS-2G <input type="checkbox"/> IX-RS-* <input type="checkbox"/> IX-SOFT <input type="checkbox"/> IXW-MA <input type="checkbox"/> IX-SPMIC <input type="checkbox"/> VoIP Phone <input type="checkbox"/> IX-DVM
Description	Select the card format of the access card.
Settings	<ul style="list-style-type: none"> • 26 bit Wiegand format (H10301) • 37 bit Wiegand format (H10302) • 37 bit Wiegand format (H10304) • Corporate1000 (35 bit) • Corporate1000 (48 bit)

■ Facility Code

Compatible type	<input type="checkbox"/> IXG-2C7(-*) <input type="checkbox"/> IXG-MK <input type="checkbox"/> IX-MV7-* <input checked="" type="checkbox"/> IXG-DM7(-*) <input type="checkbox"/> IX-DA, IX-DB <input type="checkbox"/> IX-BA, IX-BB <input type="checkbox"/> IX-DV, IX-DVF(-*) <input type="checkbox"/> IX-SSA(-*) <input type="checkbox"/> IX-EA, IX-EAU <input type="checkbox"/> IX-FA <input type="checkbox"/> IXGW-LC <input type="checkbox"/> IXGW-(T)GW <input type="checkbox"/> Intercom App <input type="checkbox"/> IX-SS-2G <input type="checkbox"/> IX-RS-* <input type="checkbox"/> IX-SOFT <input type="checkbox"/> IXW-MA <input type="checkbox"/> IX-SPMIC <input type="checkbox"/> VoIP Phone <input type="checkbox"/> IX-DVM
Description	Configure a facility code of the format selected in "Card Format."
Settings	The setting value will be configured as follows according to the information set in "Card Format." <ul style="list-style-type: none"> • 26 bit Wiegand format (H10301): 1 to 255 • 37 bit Wiegand format (H10302): None • 37 bit Wiegand format (H10304): 1 to 65535 • Corporate1000 (35 bit): 1 to 4095 • Corporate1000 (48 bit): 1 to 4194303

8.7.1 Access Card Registration

■ Unit / User Group Name◆

Compatible type	<input type="checkbox"/> IXG-2C7(-*) <input type="checkbox"/> IXG-MK <input type="checkbox"/> IX-MV7-* <input checked="" type="checkbox"/> IXG-DM7(-*) <input type="checkbox"/> IX-DA, IX-DB <input type="checkbox"/> IX-BA, IX-BB <input type="checkbox"/> IX-DV, IX-DVF(-*) <input type="checkbox"/> IX-SSA(-*) <input type="checkbox"/> IX-EA, IX-EAU <input type="checkbox"/> IX-FA <input type="checkbox"/> IXGW-LC <input type="checkbox"/> IXGW-(T)GW <input type="checkbox"/> Intercom App <input type="checkbox"/> IX-SS-2G <input type="checkbox"/> IX-RS-* <input type="checkbox"/> IX-SOFT <input type="checkbox"/> IXW-MA <input type="checkbox"/> IX-SPMIC <input type="checkbox"/> VoIP Phone <input type="checkbox"/> IX-DVM
Description	Set the name of the user group. The names of unit users cannot be changed.
Settings	1-24 alphanumeric characters

■ Access Card Mode

Compatible type	<input type="checkbox"/> IXG-2C7(-*) <input type="checkbox"/> IXG-MK <input type="checkbox"/> IX-MV7-* <input checked="" type="checkbox"/> IXG-DM7(-*) <input type="checkbox"/> IX-DA, IX-DB <input type="checkbox"/> IX-BA, IX-BB <input type="checkbox"/> IX-DV, IX-DVF(-*) <input type="checkbox"/> IX-SSA(-*) <input type="checkbox"/> IX-EA, IX-EAU <input type="checkbox"/> IX-FA <input type="checkbox"/> IXGW-LC <input type="checkbox"/> IXGW-(T)GW <input type="checkbox"/> Intercom App <input type="checkbox"/> IX-SS-2G <input type="checkbox"/> IX-RS-* <input type="checkbox"/> IX-SOFT <input type="checkbox"/> IXW-MA <input type="checkbox"/> IX-SPMIC <input type="checkbox"/> VoIP Phone <input type="checkbox"/> IX-DVM
Description	Configure whether to use cards for door release. Setting this to "Schedule 1-64" will display the schedule set in " Access Card Schedule (→page 176) ".
Settings	<ul style="list-style-type: none"> • Card Access Always ON • Card Access Always OFF • Schedule 1-64 (name set in "Schedule Name◆ (→page 177)" will be displayed) : Switch between allowing and preventing door release based on the schedule set in "Access Card Schedule (→page 176)".

■ Card Number 1 to 10

Compatible type	<input type="checkbox"/> IXG-2C7(-*) <input type="checkbox"/> IXG-MK <input type="checkbox"/> IX-MV7-* <input checked="" type="checkbox"/> IXG-DM7(-*) <input type="checkbox"/> IX-DA, IX-DB <input type="checkbox"/> IX-BA, IX-BB <input type="checkbox"/> IX-DV, IX-DVF(-*) <input type="checkbox"/> IX-SSA(-*) <input type="checkbox"/> IX-EA, IX-EAU <input type="checkbox"/> IX-FA <input type="checkbox"/> IXGW-LC <input type="checkbox"/> IXGW-(T)GW <input type="checkbox"/> Intercom App <input type="checkbox"/> IX-SS-2G <input type="checkbox"/> IX-RS-* <input type="checkbox"/> IX-SOFT <input type="checkbox"/> IXW-MA <input type="checkbox"/> IX-SPMIC <input type="checkbox"/> VoIP Phone <input type="checkbox"/> IX-DVM
Description	Set the card number.
Settings	The setting value will be configured as follows according to the information set in "Card Format." <ul style="list-style-type: none"> • 26 bit Wiegand format (H10301): 0 to 65535 • 37 bit Wiegand format (H10302): 0 to 34359738367 • 37 bit Wiegand format (H10304): 0 to 524287 • Corporate1000 (35 bit): 0 to 1048575 • Corporate1000 (48 bit): 0 to 8388607

Note

- Each card number must be unique within the same Entrance Station.

■ Relay Output 1

Compatible type	<input type="checkbox"/> IXG-2C7(-*) <input type="checkbox"/> IXG-MK <input type="checkbox"/> IX-MV7-* <input checked="" type="checkbox"/> IXG-DM7(-*) <input type="checkbox"/> IX-DA, IX-DB <input type="checkbox"/> IX-BA, IX-BB <input type="checkbox"/> IX-DV, IX-DVF(-*) <input type="checkbox"/> IX-SSA(-*) <input type="checkbox"/> IX-EA, IX-EAU <input type="checkbox"/> IX-FA <input type="checkbox"/> IXGW-LC <input type="checkbox"/> IXGW-(T)GW <input type="checkbox"/> Intercom App <input type="checkbox"/> IX-SS-2G <input type="checkbox"/> IX-RS-* <input type="checkbox"/> IX-SOFT <input type="checkbox"/> IXW-MA <input type="checkbox"/> IX-SPMIC <input type="checkbox"/> VoIP Phone <input type="checkbox"/> IX-DVM
Description	If Relay Output 1 for the Entrance Station was set to "Door Release" in "Relay Output" - "Function" in Administrator mode, configure whether to perform relay output when card verification is successful.
Settings	<ul style="list-style-type: none"> • Enable • Disable

■ Relay Output 2

Compatible type	<input type="checkbox"/> IXG-2C7(-*) <input type="checkbox"/> IXG-MK <input type="checkbox"/> IX-MV7-* <input checked="" type="checkbox"/> IXG-DM7(-*) <input type="checkbox"/> IX-DA, IX-DB <input type="checkbox"/> IX-BA, IX-BB <input type="checkbox"/> IX-DV, IX-DVF(-*) <input type="checkbox"/> IX-SSA(-*) <input type="checkbox"/> IX-EA, IX-EAU <input type="checkbox"/> IX-FA <input type="checkbox"/> IXGW-LC <input type="checkbox"/> IXGW-(T)GW <input type="checkbox"/> Intercom App <input type="checkbox"/> IX-SS-2G <input type="checkbox"/> IX-RS-* <input type="checkbox"/> IX-SOFT <input type="checkbox"/> IXW-MA <input type="checkbox"/> IX-SPMIC <input type="checkbox"/> VoIP Phone <input type="checkbox"/> IX-DVM
Description	If Relay Output 2 for the Entrance Station was set to "Door Release" in "Relay Output" - "Function" in Administrator mode, configure whether to perform relay output when card verification is successful.
Settings	<ul style="list-style-type: none"> • Enable • Disable

8.7.2 Access Card Batch Registration

Configure "Card Format," "Facility Code," and "Card Number " for multiple Entrance Stations at once. Click **[Access Card Batch Registration]** to display the following screen.

Card Format, Facility Code

Generate Access Card Settings for all Units/User Groups
Select the Entrance Station to apply settings and then register the settings in ["Access Card Registration \(→page 172\)"](#).

Import Access Card Settings from other Entrance Station
Import the "Card Number " configured in ["Access Card Registration \(→page 172\)"](#).

Building Nu	Unit Number / User Group	Entrance Station Settings	Access Card Batch Registration								
		Unit / User Group Nam	Card Information								
			Card Number 1	Card Number 2	Card Number 3	Card Number 4	Card Number 5	Card Number 6	Card Number 7	Card Number 8	Card Number 9
01	001	Entrance001									
01	002	Outside Area002									
01	101	Residential101									
01	102	Residential102									
01	201	Guard201									
01	202	Commercial									

1. To use the station card information configured in ["Access Card Registration \(→page 172\)"](#), click **[Import Access Card Settings from other Entrance Station]**, select the station that was configured, and then click "OK."
(There is no need to import information if not using card information from a station that was configured).
2. Configure "Card Format," "Facility Code," and "Card Information."
3. Click **[Generate Access Card Settings for all Units/User Groups]** and select the Entrance Station to apply settings. (Multiple selections allowed.)
4. Click **[OK]**.
5. Click **[OK]**.
 - Configuration is now complete.

8.7.3 Copy Access Card Information to other Station(s)

Copy settings to another Entrance Station.

Click [**Copy Access Card Information to other Station(s)**] to display the following screen.

IXG Support Tool - [Copy Access Card Information]

Copy Access Card Information

If the "Relay Output" of the destination station is not set to "Door Release", then the relay output for "Access Card" will be set to "Disable".

1 Copy Source Station

Building Number / Building Name

Station Number / Station Name

2 Select item(s) to copy

Access Card Information

Access Card Schedule Access Card Mode

3 Copy Destination Station(s)

Select None Selected

4 Execute Cancel

- 1.** Select the Entrance Station to copy.
- 2.** Select what to copy.
- 3.** Click [**Select**] for the destination Entrance Station to select it.
- 4.** Click [**Execute**].
 - Click [**Cancel**] to stop copying.
- 5.** Click [**OK**].
- 6.** Click [**OK**].
 - Copying is now complete.

8.8 Access Card Schedule

Configure door release schedules for each Entrance Station.

! Important

- If a schedule set in the "Weekly Schedule" and the "Holiday Schedule" overlap, the "Holiday Schedule" setting takes precedence.

Filter

Building Number / Building Name: Select the building to display.
 Station Number / Station Name: Select the station to display and then click **[Apply]** to display the door release schedule configured for the selected station.

Weekly Schedule

Select the day of the week and schedule range to configure to display on the Settings screen.

Holiday Schedule

Select the schedule range to configure to display it on the Settings screen.

1. Select the range of schedules to display (1 to 16) that can be configured for each day.
 - By default, the range of 1 - 3 is displayed.

2. Click **[Apply Display Range]**.

Move to Related Settings

Moves to the selected item within the same Settings screen.

Filter
 Building Number / Building Name:
 Station Number / Station Name:

[Display settings]
 [Weekly Schedule] [Holiday Schedule]
 Schedule View Adjustment Display Range 1 - 3

[Move to Related Settings]
 Schedule Name

Entrance Station Settings															
Access Card Schedule															
#	Schedule Name	Weekly Schedule	Sunday Operation						Monday Operation		Mon01		Mon02		
			Sun01	Sun02	Sun03			Start Time	End Time	Start Time	End Time	Start Time	End Time		
			Start Time	End Time	Start Time	End Time	Start Time	End Time							
1	Schedule1	Card Access Always							Card Access Always						
2	Schedule2	Card Access Always							Card Access Always						
3	Schedule3	Card Access Always							Card Access Always						
4	Schedule4	Card Access Always							Card Access Always						

■ Schedule Name◆

Compatible type	<input type="checkbox"/> IXG-2C7(-*) <input type="checkbox"/> IXG-MK <input type="checkbox"/> IX-MV7-* <input checked="" type="checkbox"/> IXG-DM7(-*) <input type="checkbox"/> IX-DA, IX-DB <input type="checkbox"/> IX-BA, IX-BB <input type="checkbox"/> IX-DV, IX-DVF(-*) <input type="checkbox"/> IX-SSA(-*) <input type="checkbox"/> IX-EA, IX-EAU <input type="checkbox"/> IX-FA <input type="checkbox"/> IXGW-LC <input type="checkbox"/> IXGW-(T)GW <input type="checkbox"/> Intercom App <input type="checkbox"/> IX-SS-2G <input type="checkbox"/> IX-RS-* <input type="checkbox"/> IX-SOFT <input type="checkbox"/> IXW-MA <input type="checkbox"/> IX-SPMIC <input type="checkbox"/> VoIP Phone <input type="checkbox"/> IX-DVM
Description	Set the name of the access card schedule.
Settings	1-24 alphanumeric characters

8.8.1 Weekly Schedule

Configure the door release schedule for each day of the week from Sunday through Saturday.
3 schedules can be set for each day of the week.

■ (Day) Operation

Compatible type	<input type="checkbox"/> IXG-2C7(-*) <input type="checkbox"/> IXG-MK <input type="checkbox"/> IX-MV7-* <input checked="" type="checkbox"/> IXG-DM7(-*) <input type="checkbox"/> IX-DA, IX-DB <input type="checkbox"/> IX-BA, IX-BB <input type="checkbox"/> IX-DV, IX-DVF(-*) <input type="checkbox"/> IX-SSA(-*) <input type="checkbox"/> IX-EA, IX-EAU <input type="checkbox"/> IX-FA <input type="checkbox"/> IXGW-LC <input type="checkbox"/> IXGW-(T)GW <input type="checkbox"/> Intercom App <input type="checkbox"/> IX-SS-2G <input type="checkbox"/> IX-RS-* <input type="checkbox"/> IX-SOFT <input type="checkbox"/> IXW-MA <input type="checkbox"/> IX-SPMIC <input type="checkbox"/> VoIP Phone <input type="checkbox"/> IX-DVM
Description	Configure the door release operation.
Settings	<ul style="list-style-type: none"> • Card Access Always ON • Card Access Always OFF • Set a Schedule: Switch to allowing door release during the times configured in "Start Time (→page 177)" and "End Time (→page 177)".

■ Start Time

Compatible type	<input type="checkbox"/> IXG-2C7(-*) <input type="checkbox"/> IXG-MK <input type="checkbox"/> IX-MV7-* <input checked="" type="checkbox"/> IXG-DM7(-*) <input type="checkbox"/> IX-DA, IX-DB <input type="checkbox"/> IX-BA, IX-BB <input type="checkbox"/> IX-DV, IX-DVF(-*) <input type="checkbox"/> IX-SSA(-*) <input type="checkbox"/> IX-EA, IX-EAU <input type="checkbox"/> IX-FA <input type="checkbox"/> IXGW-LC <input type="checkbox"/> IXGW-(T)GW <input type="checkbox"/> Intercom App <input type="checkbox"/> IX-SS-2G <input type="checkbox"/> IX-RS-* <input type="checkbox"/> IX-SOFT <input type="checkbox"/> IXW-MA <input type="checkbox"/> IX-SPMIC <input type="checkbox"/> VoIP Phone <input type="checkbox"/> IX-DVM
Description	If "(Day) Operation (→page 177)" was set to "Set a Schedule," configure the start time to allow door release by card.
Settings	00:00-23:59

■ End Time

Compatible type	<input type="checkbox"/> IXG-2C7(-*) <input type="checkbox"/> IXG-MK <input type="checkbox"/> IX-MV7-* <input checked="" type="checkbox"/> IXG-DM7(-*) <input type="checkbox"/> IX-DA, IX-DB <input type="checkbox"/> IX-BA, IX-BB <input type="checkbox"/> IX-DV, IX-DVF(-*) <input type="checkbox"/> IX-SSA(-*) <input type="checkbox"/> IX-EA, IX-EAU <input type="checkbox"/> IX-FA <input type="checkbox"/> IXGW-LC <input type="checkbox"/> IXGW-(T)GW <input type="checkbox"/> Intercom App <input type="checkbox"/> IX-SS-2G <input type="checkbox"/> IX-RS-* <input type="checkbox"/> IX-SOFT <input type="checkbox"/> IXW-MA <input type="checkbox"/> IX-SPMIC <input type="checkbox"/> VoIP Phone <input type="checkbox"/> IX-DVM
Description	If "(Day) Operation (→page 177)" was set to "Set a Schedule," configure the end time to allow door release by card. If this is set earlier than "Start Time," the end time will be that time on the following day.
Settings	00:00-23:59

8.8.2 Holiday Schedule

Set the door release schedule in 1-day units.
16 schedules can be set.

■ Operation

Compatible type	<input type="checkbox"/> IXG-2C7(-*) <input type="checkbox"/> IXG-MK <input type="checkbox"/> IX-MV7-* <input checked="" type="checkbox"/> IXG-DM7(-*) <input type="checkbox"/> IX-DA, IX-DB <input type="checkbox"/> IX-BA, IX-BB <input type="checkbox"/> IX-DV, IX-DVF(-*) <input type="checkbox"/> IX-SSA(-*) <input type="checkbox"/> IX-EA, IX-EAU <input type="checkbox"/> IX-FA <input type="checkbox"/> IXGW-LC <input type="checkbox"/> IXGW-(T)GW <input type="checkbox"/> Intercom App <input type="checkbox"/> IX-SS-2G <input type="checkbox"/> IX-RS-* <input type="checkbox"/> IX-SOFT <input type="checkbox"/> IXW-MA <input type="checkbox"/> IX-SPMIC <input type="checkbox"/> VoIP Phone <input type="checkbox"/> IX-DVM
Description	Configure the door release operation.
Settings	<ul style="list-style-type: none"> • Not set • Card Access Always ON • Card Access Always OFF • Set a Schedule: Switch to allowing door release during the times configured in "Start Time (→page 178)" and "End Time (→page 178)".

■ Date

Compatible type	<input type="checkbox"/> IXG-2C7(-*) <input type="checkbox"/> IXG-MK <input type="checkbox"/> IX-MV7-* <input checked="" type="checkbox"/> IXG-DM7(-*) <input type="checkbox"/> IX-DA, IX-DB <input type="checkbox"/> IX-BA, IX-BB <input type="checkbox"/> IX-DV, IX-DVF(-*) <input type="checkbox"/> IX-SSA(-*) <input type="checkbox"/> IX-EA, IX-EAU <input type="checkbox"/> IX-FA <input type="checkbox"/> IXGW-LC <input type="checkbox"/> IXGW-(T)GW <input type="checkbox"/> Intercom App <input type="checkbox"/> IX-SS-2G <input type="checkbox"/> IX-RS-* <input type="checkbox"/> IX-SOFT <input type="checkbox"/> IXW-MA <input type="checkbox"/> IX-SPMIC <input type="checkbox"/> VoIP Phone <input type="checkbox"/> IX-DVM
Description	Configure the date to allow door release.
Settings	From the current date until the end of the month 1 year later

■ Start Time

Compatible type	<input type="checkbox"/> IXG-2C7(-*) <input type="checkbox"/> IXG-MK <input type="checkbox"/> IX-MV7-* <input checked="" type="checkbox"/> IXG-DM7(-*) <input type="checkbox"/> IX-DA, IX-DB <input type="checkbox"/> IX-BA, IX-BB <input type="checkbox"/> IX-DV, IX-DVF(-*) <input type="checkbox"/> IX-SSA(-*) <input type="checkbox"/> IX-EA, IX-EAU <input type="checkbox"/> IX-FA <input type="checkbox"/> IXGW-LC <input type="checkbox"/> IXGW-(T)GW <input type="checkbox"/> Intercom App <input type="checkbox"/> IX-SS-2G <input type="checkbox"/> IX-RS-* <input type="checkbox"/> IX-SOFT <input type="checkbox"/> IXW-MA <input type="checkbox"/> IX-SPMIC <input type="checkbox"/> VoIP Phone <input type="checkbox"/> IX-DVM
Description	If " Operation (→page 178) " was set to "Set a Schedule," configure the start time to allow door release by card.
Settings	00:00-23:59

■ End Time

Compatible type	<input type="checkbox"/> IXG-2C7(-*) <input type="checkbox"/> IXG-MK <input type="checkbox"/> IX-MV7-* <input checked="" type="checkbox"/> IXG-DM7(-*) <input type="checkbox"/> IX-DA, IX-DB <input type="checkbox"/> IX-BA, IX-BB <input type="checkbox"/> IX-DV, IX-DVF(-*) <input type="checkbox"/> IX-SSA(-*) <input type="checkbox"/> IX-EA, IX-EAU <input type="checkbox"/> IX-FA <input type="checkbox"/> IXGW-LC <input type="checkbox"/> IXGW-(T)GW <input type="checkbox"/> Intercom App <input type="checkbox"/> IX-SS-2G <input type="checkbox"/> IX-RS-* <input type="checkbox"/> IX-SOFT <input type="checkbox"/> IXW-MA <input type="checkbox"/> IX-SPMIC <input type="checkbox"/> VoIP Phone <input type="checkbox"/> IX-DVM
Description	If " Operation (→page 178) " was set to "Set a Schedule," configure the end time to allow door release by card. If this is set earlier than "Start Time," the end time will be that time on the following day.
Settings	00:00-23:59

8.9 Access Code

If releasing the electrical lock by entering an access code on the Entrance Station for each Entrance Station, configure the door release access code for each unit.

Filter
 Building Number / Building Name: Select the building to display.
 Station Number / Station Name: Select the station to display and then click **[Apply]**. The door release access codes for each unit released using the selected station are displayed.

Length
 "Add Access Code (→page 180)"
 "Delete Access Code (→page 181)"

Filter

Building Number / Building Name:

Station Number / Station Name:

Length
4

Add Access Code

Delete Access Code

Building Number	Unit Number	Unit Name	Entrance Station Settings				
			Access Code	Access Code		Access Code	
				with Touch Panel	with Physical Keypad (for IXG-DM7-10K only)		
			Relay Output 1	Relay Output 2	Relay Output 1	Relay Output 2	
01	0001	Residential203	1111	A1111		#11111	
01	0002	Outside Area 0002					
01	101	Residential101					
01	102	Residential102					
01	103	Residential103					
01	104	Residential104					
01	105	Residential105					
01	106	Residential106					
01	201	Guard201					

How to configure access codes

1. Use "Filter" to select the Entrance Station for which to configure an access code, and then click **[Apply]**.
 - The Settings screen for the selected Entrance Station will be displayed.
2. Enter the door release access code for each unit.
 - Access Code: Enter using the number of digits displayed under "Length." The touch panel door release code and physical keypad button door release code are displayed.
 - The touch panel and physical keypad button access codes differ.
 - with Touch Panel (Relay Output 1): "A" + "access code"
 - with Touch Panel (Relay Output 2): "B" + "access code"
 - with Physical Keypad (Relay Output 1): "#" + "1" + "access code"
 - with Physical Keypad (Relay Output 2): "#" + "2" + "access code"

8.9.1 Add Access Code

Configure the same door release access code for multiple Entrance Stations at once, for each unit. Click **[Add Access Code]**. The "Add Access Code" screen will be displayed.

1 Access Code

2 Select a Unit to associate to this Access Code.
 Building Number
 Unit Number

3 Select Entrances to release the door by this Access Code.

Select	Building Number	Unit Number	Station Name	Length
<input type="checkbox"/>	01	001	Entrance Station1	4
<input type="checkbox"/>	01	001	Entrance Station2	4
<input type="checkbox"/>	01	4444	Entrance Station1	4
<input type="checkbox"/>	01	4444	Entrance Station2	4

4

How to Add Access Code

- 1.** Enter the "Access Code."
 - Access Code: Configure using the number of digits displayed under "Length" in ["How to configure access codes \(→page 179\)"](#).
- 2.** Select the "Building Number" of the unit to use the door release access code that was entered, and then enter the "Unit Number."
- 3.** Select the Entrance Station to configure a door release access code. (Multiple selections allowed.)
- 4.** Click **[Add]**.
 - The door release access code is configured for the selected unit number.
 - Click **[Cancel]** to exit.

 **Note**

- To confirm the configured access codes, use "Filter" to select the "Building Number / Building Name" and "Station Number / Station Name" for the Entrance Station, and then click **[Apply]**.

8.9.2 Delete Access Code

Delete registered access codes.

Click **[Delete Access Code]**. The "Delete Access Code" screen will be displayed.

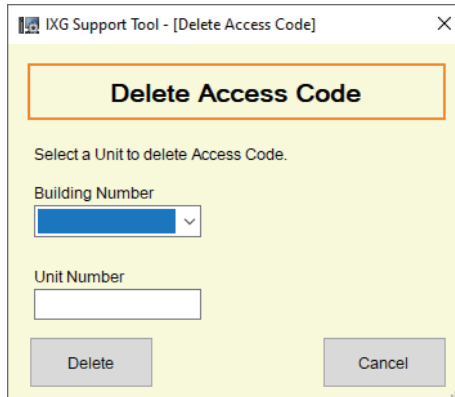

How to Delete Access Code

1. Select the "Building Number" of the unit to delete an access code, and then enter the "Unit Number."
2. Click **[Delete]**.
 - The door release access code is deleted for the selected unit number.
 - Click **[Cancel]** to exit.

 **Note**

- To confirm whether an access code was deleted, use "Filter" to select the "Building Number / Building Name" and "Station Number / Station Name" for the Entrance Station, and then click **[Apply]**.

9. Function Settings (Advanced Settings)

9.1 Door Release QR Code Settings

Configure the Entrance Stations that can be released using the Intercom App QR code, for each unit.

List of units with registered Intercom Apps

List of Entrance Stations

Building Number	Unit Number	Unit Name	Function Settings
			Door Release QR Code Settings
			Building Number01
			001 / 010010
			Entrance Station1 / IXG-DM7
01	0001	Residential203	<input checked="" type="checkbox"/>
01	101	Residential101	<input checked="" type="checkbox"/>
01	102	Residential102	<input checked="" type="checkbox"/>
01	103	Residential103	<input checked="" type="checkbox"/>

! Important

- Door release using a QR code may not be possible depending on the network connection status.
- To perform door release using a QR code, configure the following settings for IXG-DM7(-*):
 - Set "Relay Output" - "Door Release QR Code" to "Enable" in Administrator mode
 - Set Door Release QR Code to "Enable"

How to configure

1. Search for the unit to configure from the "List of units with registered Intercom Apps."
2. Search for the station to configure from "List of Entrance Stations."
3. Click the cell that corresponds to Steps 1 and 2.
 - Select: Configure the QR door release function for an Entrance Station where "✓" is selected.
 - The Entrance Station with "✓" selected in the same building is set by default.
4. After configuration is complete, click **[Update]**.
5. Click **[OK]**.

9.2 Paging

Configure incoming page settings.

Move row

Up to 50 station number rows can be displayed at a time. Switch the screen as follows.

[Previous]: Display the previous 50 rows.

[Next]: Display the next 50 rows.

[Apply]: Enter the station number and click **[Apply]** to move the cursor to the row of the station number that was entered.

Row
Previous
NextApply

Building Number	Unit Number	Station Name	Function Settings
			Paging
			Paging Pretone
01	001	Entrance Station1	Pre Tone 2
01	001	Entrance Station2	Pre Tone 2
01	002	Video Door Station1	Pre Tone 2

■ Paging Pretone

Compatible type	<input type="checkbox"/> IXG-2C7(-*) <input type="checkbox"/> IXG-MK <input type="checkbox"/> IX-MV7-* <input checked="" type="checkbox"/> IXG-DM7(-*) <input checked="" type="checkbox"/> IX-DA, IX-DB <input checked="" type="checkbox"/> IX-BA, IX-BB <input checked="" type="checkbox"/> IX-DV, IX-DVF(-*) <input checked="" type="checkbox"/> IX-SSA(-*) <input checked="" type="checkbox"/> IX-EA IX-EAU <input type="checkbox"/> IX-FA <input type="checkbox"/> IXGW-LC <input type="checkbox"/> IXGW-(T)GW <input type="checkbox"/> Intercom App <input checked="" type="checkbox"/> IX-SS-2G <input checked="" type="checkbox"/> IX-RS-* <input type="checkbox"/> IX-SOFT <input type="checkbox"/> IXW-MA <input type="checkbox"/> IX-SPMIC <input type="checkbox"/> VoIP Phone <input checked="" type="checkbox"/> IX-DVM
Description	Select the Paging Pretone.
Settings	<ul style="list-style-type: none"> • None • Call Pattern 1 • Call Pattern 2 • Call Pattern 3 • Call Pattern 4 • Call Pattern 5 • Call Pattern 6 • Call Pattern 7 (IX-EA and IX-DVM only) • Tremolo Sound • Busy Response Tone • On Hold • Operation Sound • Error • Pre Tone 1 • Pre Tone 2 • Pre Tone 3 • Communication End Pretone • Call Queue Notification • Waiting Reply Tone • Select a sound that is registered in "Custom Sound Registry (→page 117)". IX-DA, IX-DB, IX-BA, IX-BB can be set to "None" and "Pre Tone 2."

! Important

- Configure a tone with a shorter duration than the paging pretone on the paging origination station. Configuring a longer tone might prevent the station from receiving audio when paging begins.

9.3 Email

Configure this section when email notification of station operation is required.

Move row

Up to 50 station number rows can be displayed at a time. Switch the screen as follows.

[Previous]: Display the previous 50 rows.

[Next]: Display the next 50 rows.

[Apply]: Enter the station number and click **[Apply]** to move the cursor to the row of the station number that was entered.

Display settings

Select the event (sending trigger) to configure. The Settings screen is displayed. [“How to perform Event View Selection \(→page 191\)”](#)

Move to Related Settings

Moves to the selected item within the same Settings screen.

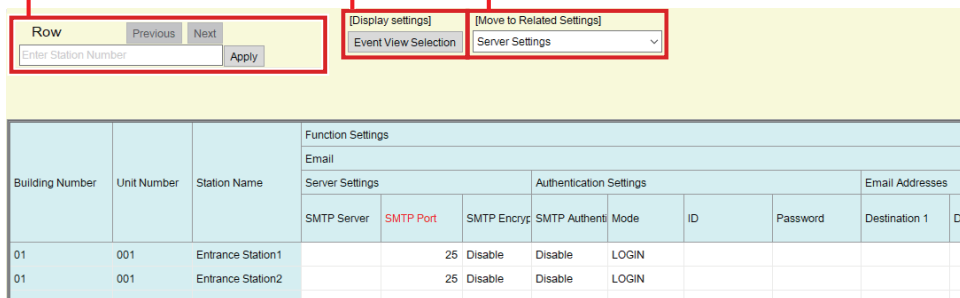

9.3.1 Server Settings

■ SMTP Server

Compatible type	<input type="checkbox"/> IXG-2C7(-*) <input checked="" type="checkbox"/> IXG-MK <input checked="" type="checkbox"/> IX-MV7-* <input checked="" type="checkbox"/> IXG-DM7(-*) <input checked="" type="checkbox"/> IX-DA, IX-DB <input checked="" type="checkbox"/> IX-BA, IX-BB <input checked="" type="checkbox"/> IX-DV, IX-DVF(-*) <input checked="" type="checkbox"/> IX-SSA(-*) <input checked="" type="checkbox"/> IX-EA, IX-EAU <input type="checkbox"/> IX-FA <input checked="" type="checkbox"/> IXGW-LC <input type="checkbox"/> IXGW-(T)GW <input type="checkbox"/> Intercom App <input checked="" type="checkbox"/> IX-SS-2G <input checked="" type="checkbox"/> IX-RS-* <input checked="" type="checkbox"/> IX-SOFT <input checked="" type="checkbox"/> IXW-MA <input type="checkbox"/> IX-SPMIC <input type="checkbox"/> VoIP Phone <input checked="" type="checkbox"/> IX-DVM
Description	Set the SMTP server. When choosing an IPv4 address, enter the IP address or the hostname. Use the hostname to configure an IPv6 address. When setting the hostname, configure "DNS Server" in Administrator mode.
Settings	1-255 alphanumeric characters

■ SMTP Port◆

Compatible type	<input type="checkbox"/> IXG-2C7(-*) <input checked="" type="checkbox"/> IXG-MK <input checked="" type="checkbox"/> IX-MV7-* <input checked="" type="checkbox"/> IXG-DM7(-*) <input checked="" type="checkbox"/> IX-DA, IX-DB <input checked="" type="checkbox"/> IX-BA, IX-BB <input checked="" type="checkbox"/> IX-DV, IX-DVF(-*) <input checked="" type="checkbox"/> IX-SSA(-*) <input checked="" type="checkbox"/> IX-EA, IX-EAU <input type="checkbox"/> IX-FA <input checked="" type="checkbox"/> IXGW-LC <input type="checkbox"/> IXGW-(T)GW <input type="checkbox"/> Intercom App <input checked="" type="checkbox"/> IX-SS-2G <input checked="" type="checkbox"/> IX-RS-* <input checked="" type="checkbox"/> IX-SOFT <input checked="" type="checkbox"/> IXW-MA <input type="checkbox"/> IX-SPMIC <input type="checkbox"/> VoIP Phone <input checked="" type="checkbox"/> IX-DVM
Description	Configure the port number used for SMTP.
Settings	1 - 65535

■ SMTP Encryption

Compatible type	<input type="checkbox"/> IXG-2C7(-*) <input checked="" type="checkbox"/> IXG-MK <input checked="" type="checkbox"/> IX-MV7-* <input checked="" type="checkbox"/> IXG-DM7(-*) <input checked="" type="checkbox"/> IX-DA, IX-DB <input checked="" type="checkbox"/> IX-BA, IX-BB <input checked="" type="checkbox"/> IX-DV, IX-DVF(-*) <input checked="" type="checkbox"/> IX-SSA(-*) <input checked="" type="checkbox"/> IX-EA, IX-EAU <input type="checkbox"/> IX-FA <input checked="" type="checkbox"/> IXGW-LC <input type="checkbox"/> IXGW-(T)GW <input type="checkbox"/> Intercom App <input checked="" type="checkbox"/> IX-SS-2G, <input checked="" type="checkbox"/> IX-RS-* <input checked="" type="checkbox"/> IX-SOFT <input checked="" type="checkbox"/> IXW-MA <input type="checkbox"/> IX-SPMIC <input type="checkbox"/> VoIP Phone <input checked="" type="checkbox"/> IX-DVM
Description	Configure the encryption type for SMTP.
Settings	<ul style="list-style-type: none"> • Disable • TLS • STARTTLS

9.3.2 Authentication Settings

■ SMTP Authentication

Compatible type	<input type="checkbox"/> IXG-2C7(-*) <input checked="" type="checkbox"/> IXG-MK <input checked="" type="checkbox"/> IX-MV7-* <input checked="" type="checkbox"/> IXG-DM7(-*) <input checked="" type="checkbox"/> IX-DA, IX-DB <input checked="" type="checkbox"/> IX-BA, IX-BB <input checked="" type="checkbox"/> IX-DV, IX-DVF(-*) <input checked="" type="checkbox"/> IX-SSA(-*) <input checked="" type="checkbox"/> IX-EA, IX-EAU <input type="checkbox"/> IX-FA <input checked="" type="checkbox"/> IXGW-LC <input type="checkbox"/> IXGW-(T)GW <input type="checkbox"/> Intercom App <input checked="" type="checkbox"/> IX-SS-2G <input checked="" type="checkbox"/> IX-RS-* <input checked="" type="checkbox"/> IX-SOFT <input checked="" type="checkbox"/> IXW-MA <input type="checkbox"/> IX-SPMIC <input type="checkbox"/> VoIP Phone <input checked="" type="checkbox"/> IX-DVM
Description	Select Enable / Disable for SMTP Authentication.
Settings	<ul style="list-style-type: none"> • Enable • Disable

■ Mode

Compatible type	<input type="checkbox"/> IXG-2C7(-*) <input checked="" type="checkbox"/> IXG-MK <input checked="" type="checkbox"/> IX-MV7-* <input checked="" type="checkbox"/> IXG-DM7(-*) <input checked="" type="checkbox"/> IX-DA, IX-DB <input checked="" type="checkbox"/> IX-BA, IX-BB <input checked="" type="checkbox"/> IX-DV, IX-DVF(-*) <input checked="" type="checkbox"/> IX-SSA(-*) <input checked="" type="checkbox"/> IX-EA, IX-EAU <input type="checkbox"/> IX-FA <input checked="" type="checkbox"/> IXGW-LC <input type="checkbox"/> IXGW-(T)GW <input type="checkbox"/> Intercom App <input checked="" type="checkbox"/> IX-SS-2G <input checked="" type="checkbox"/> IX-RS-* <input checked="" type="checkbox"/> IX-SOFT <input checked="" type="checkbox"/> IXW-MA <input type="checkbox"/> IX-SPMIC <input type="checkbox"/> VoIP Phone <input checked="" type="checkbox"/> IX-DVM
Description	Configure the SMTP authentication mode.
Settings	<ul style="list-style-type: none"> • LOGIN • CRAM-MD5

■ ID

Compatible type	<input type="checkbox"/> IXG-2C7(-*) <input checked="" type="checkbox"/> IXG-MK <input checked="" type="checkbox"/> IX-MV7-* <input checked="" type="checkbox"/> IXG-DM7(-*) <input checked="" type="checkbox"/> IX-DA, IX-DB <input checked="" type="checkbox"/> IX-BA, IX-BB <input checked="" type="checkbox"/> IX-DV, IX-DVF(-*) <input checked="" type="checkbox"/> IX-SSA(-*) <input checked="" type="checkbox"/> IX-EA, IX-EAU <input type="checkbox"/> IX-FA <input checked="" type="checkbox"/> IXGW-LC <input type="checkbox"/> IXGW-(T)GW <input type="checkbox"/> Intercom App <input checked="" type="checkbox"/> IX-SS-2G <input checked="" type="checkbox"/> IX-RS-* <input checked="" type="checkbox"/> IX-SOFT <input checked="" type="checkbox"/> IXW-MA <input type="checkbox"/> IX-SPMIC <input type="checkbox"/> VoIP Phone <input checked="" type="checkbox"/> IX-DVM
Description	Configure the ID for SMTP authentication.
Settings	1-64 alphanumeric characters

■ Password

Compatible type	<input type="checkbox"/> IXG-2C7(-*) <input checked="" type="checkbox"/> IXG-MK <input checked="" type="checkbox"/> IX-MV7-* <input checked="" type="checkbox"/> IXG-DM7(-*) <input checked="" type="checkbox"/> IX-DA, IX-DB <input checked="" type="checkbox"/> IX-BA, IX-BB <input checked="" type="checkbox"/> IX-DV, IX-DVF(-*) <input checked="" type="checkbox"/> IX-SSA(-*) <input checked="" type="checkbox"/> IX-EA, IX-EAU <input type="checkbox"/> IX-FA <input checked="" type="checkbox"/> IXGW-LC <input type="checkbox"/> IXGW-(T)GW <input type="checkbox"/> Intercom App <input checked="" type="checkbox"/> IX-SS-2G <input checked="" type="checkbox"/> IX-RS-* <input checked="" type="checkbox"/> IX-SOFT <input checked="" type="checkbox"/> IXW-MA <input type="checkbox"/> IX-SPMIC <input type="checkbox"/> VoIP Phone <input checked="" type="checkbox"/> IX-DVM
Description	Configure the password for SMTP authentication.
Settings	1-64 alphanumeric characters

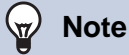

Note

- "Password" is displayed as "*****" in the Settings screen.

9.3.3 Email Addresses

■ Destination 1 to 10

Compatible type	<input type="checkbox"/> IXG-2C7(-*) <input checked="" type="checkbox"/> IXG-MK <input checked="" type="checkbox"/> IX-MV7-* <input checked="" type="checkbox"/> IXG-DM7(-*) <input checked="" type="checkbox"/> IX-DA, IX-DB <input checked="" type="checkbox"/> IX-BA, IX-BB <input checked="" type="checkbox"/> IX-DV, IX-DVF(-*) <input checked="" type="checkbox"/> IX-SSA(-*) <input checked="" type="checkbox"/> IX-EA, IX-EAU <input type="checkbox"/> IX-FA <input checked="" type="checkbox"/> IXGW-LC <input type="checkbox"/> IXGW-(T)GW <input type="checkbox"/> Intercom App <input checked="" type="checkbox"/> IX-SS-2G <input checked="" type="checkbox"/> IX-RS-* <input checked="" type="checkbox"/> IX-SOFT <input checked="" type="checkbox"/> IXW-MA <input type="checkbox"/> IX-SPMIC <input type="checkbox"/> VoIP Phone <input checked="" type="checkbox"/> IX-DVM
Description	Set the destination email address. Up to 3 can be configured for stations except IX-SOFT.
Settings	1-64 alphanumeric characters

■ Source Address

Compatible type	<input type="checkbox"/> IXG-2C7(-*) <input checked="" type="checkbox"/> IXG-MK <input checked="" type="checkbox"/> IX-MV7-* <input checked="" type="checkbox"/> IXG-DM7(-*) <input checked="" type="checkbox"/> IX-DA, IX-DB <input checked="" type="checkbox"/> IX-BA, IX-BB <input checked="" type="checkbox"/> IX-DV, IX-DVF(-*) <input checked="" type="checkbox"/> IX-SSA(-*) <input checked="" type="checkbox"/> IX-EA, IX-EAU <input type="checkbox"/> IX-FA <input checked="" type="checkbox"/> IXGW-LC <input type="checkbox"/> IXGW-(T)GW <input type="checkbox"/> Intercom App <input checked="" type="checkbox"/> IX-SS-2G <input checked="" type="checkbox"/> IX-RS-* <input checked="" type="checkbox"/> IX-SOFT <input checked="" type="checkbox"/> IXW-MA <input type="checkbox"/> IX-SPMIC <input type="checkbox"/> VoIP Phone <input checked="" type="checkbox"/> IX-DVM
Description	Set the source email address.
Settings	1-64 alphanumeric characters

9.3.4 Email Event Trigger

Configure the trigger used to send email. The email event trigger can be configured for each destination address.

■ Outgoing Normal Call

Compatible type	<input type="checkbox"/> IXG-2C7(-*) <input checked="" type="checkbox"/> IXG-MK <input checked="" type="checkbox"/> IX-MV7-* <input type="checkbox"/> IXG-DM7(-*) <input checked="" type="checkbox"/> IX-DA, IX-DB <input checked="" type="checkbox"/> IX-BA, IX-BB <input checked="" type="checkbox"/> IX-DV, IX-DVF(-*) <input checked="" type="checkbox"/> IX-SSA(-*) <input checked="" type="checkbox"/> IX-EA, IX-EAU <input type="checkbox"/> IX-FA <input type="checkbox"/> IXGW-LC <input type="checkbox"/> IXGW-(T)GW <input type="checkbox"/> Intercom App <input checked="" type="checkbox"/> IX-SS-2G <input checked="" type="checkbox"/> IX-RS-* <input checked="" type="checkbox"/> IX-SOFT <input type="checkbox"/> IXW-MA <input type="checkbox"/> IX-SPMIC <input type="checkbox"/> VoIP Phone <input checked="" type="checkbox"/> IX-DVM
Description	Send email when an outgoing call of "Normal" priority is made.
Settings	<ul style="list-style-type: none"> • Checked: Send • Unchecked: Do not send

■ Incoming Normal Call

Compatible type	<input type="checkbox"/> IXG-2C7(-*) <input checked="" type="checkbox"/> IXG-MK <input checked="" type="checkbox"/> IX-MV7-* <input type="checkbox"/> IXG-DM7(-*) <input type="checkbox"/> IX-DA, IX-DB <input type="checkbox"/> IX-BA, IX-BB <input checked="" type="checkbox"/> IX-DV, IX-DVF(-*) <input checked="" type="checkbox"/> IX-SSA(-*) <input checked="" type="checkbox"/> IX-EA, IX-EAU <input type="checkbox"/> IX-FA <input type="checkbox"/> IXGW-LC <input type="checkbox"/> IXGW-(T)GW <input type="checkbox"/> Intercom App <input checked="" type="checkbox"/> IX-SS-2G <input checked="" type="checkbox"/> IX-RS-* <input checked="" type="checkbox"/> IX-SOFT <input type="checkbox"/> IXW-MA <input type="checkbox"/> IX-SPMIC <input type="checkbox"/> VoIP Phone <input checked="" type="checkbox"/> IX-DVM
Description	Send email when an incoming call of "Normal" priority is received.
Settings	<ul style="list-style-type: none"> • Checked: Send • Unchecked: Do not send

■ Outgoing Priority Call

Compatible type	<input type="checkbox"/> IXG-2C7(-*) <input checked="" type="checkbox"/> IXG-MK <input checked="" type="checkbox"/> IX-MV7-* <input type="checkbox"/> IXG-DM7(-*) <input checked="" type="checkbox"/> IX-DA, IX-DB <input checked="" type="checkbox"/> IX-BA, IX-BB <input checked="" type="checkbox"/> IX-DV, IX-DVF(-*) <input checked="" type="checkbox"/> IX-SSA(-*) <input checked="" type="checkbox"/> IX-EA, IX-EAU <input type="checkbox"/> IX-FA <input type="checkbox"/> IXGW-LC <input type="checkbox"/> IXGW-(T)GW <input type="checkbox"/> Intercom App <input checked="" type="checkbox"/> IX-SS-2G <input checked="" type="checkbox"/> IX-RS-* <input checked="" type="checkbox"/> IX-SOFT <input type="checkbox"/> IXW-MA <input type="checkbox"/> IX-SPMIC <input type="checkbox"/> VoIP Phone <input checked="" type="checkbox"/> IX-DVM
Description	Send email when an outgoing call of "Priority" priority is made.
Settings	<ul style="list-style-type: none"> • Checked: Send • Unchecked: Do not send

■ Incoming Priority Call

Compatible type	<input type="checkbox"/> IXG-2C7(-*) <input checked="" type="checkbox"/> IXG-MK <input checked="" type="checkbox"/> IX-MV7-* <input type="checkbox"/> IXG-DM7(-*) <input type="checkbox"/> IX-DA, IX-DB <input type="checkbox"/> IX-BA, IX-BB <input checked="" type="checkbox"/> IX-DV, IX-DVF(-*) <input checked="" type="checkbox"/> IX-SSA(-*) <input checked="" type="checkbox"/> IX-EA, IX-EAU <input type="checkbox"/> IX-FA <input type="checkbox"/> IXGW-LC <input type="checkbox"/> IXGW-(T)GW <input type="checkbox"/> Intercom App <input checked="" type="checkbox"/> IX-SS-2G <input checked="" type="checkbox"/> IX-RS-* <input checked="" type="checkbox"/> IX-SOFT <input type="checkbox"/> IXW-MA <input type="checkbox"/> IX-SPMIC <input type="checkbox"/> VoIP Phone <input checked="" type="checkbox"/> IX-DVM
Description	Send email when an incoming call of "Priority" priority is received.
Settings	<ul style="list-style-type: none"> • Checked: Send • Unchecked: Do not send

■ Outgoing Urgent Call

Compatible type	<input type="checkbox"/> IXG-2C7(-*) <input checked="" type="checkbox"/> IXG-MK <input checked="" type="checkbox"/> IX-MV7-* <input type="checkbox"/> IXG-DM7(-*) <input checked="" type="checkbox"/> IX-DA, IX-DB <input checked="" type="checkbox"/> IX-BA, IX-BB <input checked="" type="checkbox"/> IX-DV, IX-DVF(-*) <input checked="" type="checkbox"/> IX-SSA(-*) <input checked="" type="checkbox"/> IX-EA, IX-EAU <input type="checkbox"/> IX-FA <input type="checkbox"/> IXGW-LC <input type="checkbox"/> IXGW-(T)GW <input type="checkbox"/> Intercom App <input checked="" type="checkbox"/> IX-SS-2G <input checked="" type="checkbox"/> IX-RS-* <input checked="" type="checkbox"/> IX-SOFT <input type="checkbox"/> IXW-MA <input type="checkbox"/> IX-SPMIC <input type="checkbox"/> VoIP Phone <input checked="" type="checkbox"/> IX-DVM
Description	Send email when an outgoing call of "Urgent" priority is made.
Settings	<ul style="list-style-type: none"> • Checked: Send • Unchecked: Do not send

■ Incoming Urgent Call

Compatible type	<input type="checkbox"/> IXG-2C7(-*) <input checked="" type="checkbox"/> IXG-MK <input checked="" type="checkbox"/> IX-MV7-* <input type="checkbox"/> IXG-DM7(-*) <input type="checkbox"/> IX-DA, IX-DB <input type="checkbox"/> IX-BA, IX-BB <input checked="" type="checkbox"/> IX-DV, IX-DVF(-*) <input checked="" type="checkbox"/> IX-SSA(-*) <input checked="" type="checkbox"/> IX-EA, IX-EAU <input type="checkbox"/> IX-FA <input type="checkbox"/> IXGW-LC <input type="checkbox"/> IXGW-(T)GW <input type="checkbox"/> Intercom App <input checked="" type="checkbox"/> IX-SS-2G <input checked="" type="checkbox"/> IX-RS-* <input checked="" type="checkbox"/> IX-SOFT <input type="checkbox"/> IXW-MA <input type="checkbox"/> IX-SPMIC <input type="checkbox"/> VoIP Phone <input checked="" type="checkbox"/> IX-DVM
Description	Send email when an incoming call of "Urgent" priority is received.
Settings	<ul style="list-style-type: none"> • Checked: Send • Unchecked: Do not send

■ Door Release Activated

Compatible type	<input type="checkbox"/> IXG-2C7(-*) <input checked="" type="checkbox"/> IXG-MK <input checked="" type="checkbox"/> IX-MV7-* <input type="checkbox"/> IXG-DM7(-*) <input type="checkbox"/> IX-DA, IX-DB <input type="checkbox"/> IX-BA, IX-BB <input type="checkbox"/> IX-DV, IX-DVF(-*) <input type="checkbox"/> IX-SSA(-*) <input type="checkbox"/> IX-EA, IX-EAU <input type="checkbox"/> IX-FA <input type="checkbox"/> IXGW-LC <input type="checkbox"/> IXGW-(T)GW <input type="checkbox"/> Intercom App <input type="checkbox"/> IX-SS-2G <input checked="" type="checkbox"/> IX-RS-* <input checked="" type="checkbox"/> IX-SOFT <input type="checkbox"/> IXW-MA <input type="checkbox"/> IX-SPMIC <input type="checkbox"/> VoIP Phone <input type="checkbox"/> IX-DVM
Description	Send email when Door Release is activated.
Settings	<ul style="list-style-type: none"> • Checked: Send • Unchecked: Do not send

■ Call Failed

Compatible type	<input type="checkbox"/> IXG-2C7(-*) <input checked="" type="checkbox"/> IXG-MK <input checked="" type="checkbox"/> IX-MV7-* <input type="checkbox"/> IXG-DM7(-*) <input checked="" type="checkbox"/> IX-DA, IX-DB <input checked="" type="checkbox"/> IX-BA, IX-BB <input checked="" type="checkbox"/> IX-DV, IX-DVF(-*) <input checked="" type="checkbox"/> IX-SSA(-*) <input checked="" type="checkbox"/> IX-EA, IX-EAU <input type="checkbox"/> IX-FA <input type="checkbox"/> IXGW-LC <input type="checkbox"/> IXGW-(T)GW <input type="checkbox"/> Intercom App <input checked="" type="checkbox"/> IX-SS-2G <input checked="" type="checkbox"/> IX-RS-* <input checked="" type="checkbox"/> IX-SOFT <input type="checkbox"/> IXW-MA <input type="checkbox"/> IX-SPMIC <input type="checkbox"/> VoIP Phone <input checked="" type="checkbox"/> IX-DVM
Description	Send email when outgoing call has failed.
Settings	<ul style="list-style-type: none"> • Checked: Send • Unchecked: Do not send

■ Latch Reset

Compatible type	<input type="checkbox"/> IXG-2C7(-*) <input type="checkbox"/> IXG-MK <input type="checkbox"/> IX-MV7-* <input type="checkbox"/> IXG-DM7(-*) <input type="checkbox"/> IX-DA, IX-DB <input type="checkbox"/> IX-BA, IX-BB <input checked="" type="checkbox"/> IX-DV, IX-DVF(-*) <input checked="" type="checkbox"/> IX-SSA(-*) <input checked="" type="checkbox"/> IX-EA, IX-EAU <input type="checkbox"/> IX-FA <input type="checkbox"/> IXGW-LC <input type="checkbox"/> IXGW-(T)GW <input type="checkbox"/> Intercom App <input checked="" type="checkbox"/> IX-SS-2G <input checked="" type="checkbox"/> IX-RS-* <input type="checkbox"/> IX-SOFT <input type="checkbox"/> IXW-MA <input type="checkbox"/> IX-SPMIC <input type="checkbox"/> VoIP Phone <input checked="" type="checkbox"/> IX-DVM
Description	If "Relay Output" - "Function" was set to "Latch Output" in Administrator mode, send email when the rotating light is restored.
Settings	<ul style="list-style-type: none"> • Checked: Send • Unchecked: Do not send

■ Error

Compatible type	<input type="checkbox"/> IXG-2C7(-*) <input checked="" type="checkbox"/> IXG-MK <input checked="" type="checkbox"/> IX-MV7-* <input type="checkbox"/> IXG-DM7(-*) <input checked="" type="checkbox"/> IX-DA, IX-DB <input checked="" type="checkbox"/> IX-BA, IX-BB <input checked="" type="checkbox"/> IX-DV, IX-DVF(-*) <input checked="" type="checkbox"/> IX-SSA(-*) <input checked="" type="checkbox"/> IX-EA, IX-EAU <input type="checkbox"/> IX-FA <input checked="" type="checkbox"/> IXGW-LC <input type="checkbox"/> IXGW-(T)GW <input type="checkbox"/> Intercom App <input checked="" type="checkbox"/> IX-SS-2G <input checked="" type="checkbox"/> IX-RS-* <input checked="" type="checkbox"/> IX-SOFT <input checked="" type="checkbox"/> IXW-MA <input type="checkbox"/> IX-SPMIC <input type="checkbox"/> VoIP Phone <input checked="" type="checkbox"/> IX-DVM
Description	Send email when a communication error has occurred.
Settings	<ul style="list-style-type: none"> • Checked: Send • Unchecked: Do not send

■ Station Restarted

Compatible type	<input type="checkbox"/> IXG-2C7(-*) <input checked="" type="checkbox"/> IXG-MK <input checked="" type="checkbox"/> IX-MV7-* <input type="checkbox"/> IXG-DM7(-*) <input checked="" type="checkbox"/> IX-DA, IX-DB <input checked="" type="checkbox"/> IX-BA, IX-BB <input checked="" type="checkbox"/> IX-DV, IX-DVF(-*) <input checked="" type="checkbox"/> IX-SSA(-*) <input checked="" type="checkbox"/> IX-EA, IX-EAU <input type="checkbox"/> IX-FA <input checked="" type="checkbox"/> IXGW-LC <input type="checkbox"/> IXGW-(T)GW <input type="checkbox"/> Intercom App <input checked="" type="checkbox"/> IX-SS-2G <input checked="" type="checkbox"/> IX-RS-* <input checked="" type="checkbox"/> IX-SOFT <input checked="" type="checkbox"/> IXW-MA <input type="checkbox"/> IX-SPMIC <input type="checkbox"/> VoIP Phone <input checked="" type="checkbox"/> IX-DVM
Description	Send email when the station or IX-SOFT restarts.
Settings	<ul style="list-style-type: none"> • Checked: Send • Unchecked: Do not send

■ SD Card Error

Compatible type	<input type="checkbox"/> IXG-2C7(-*) <input checked="" type="checkbox"/> IXG-MK <input checked="" type="checkbox"/> IX-MV7-* <input checked="" type="checkbox"/> IXG-DM7(-*) <input type="checkbox"/> IX-DA, IX-DB <input type="checkbox"/> IX-BA, IX-BB <input checked="" type="checkbox"/> IX-DV, IX-DVF(-*) <input checked="" type="checkbox"/> IX-SSA(-*) <input checked="" type="checkbox"/> IX-EA, IX-EAU <input type="checkbox"/> IX-FA <input type="checkbox"/> IXGW-LC <input type="checkbox"/> IXGW-(T)GW <input type="checkbox"/> Intercom App <input type="checkbox"/> IX-SS-2G <input type="checkbox"/> IX-RS-* <input checked="" type="checkbox"/> IX-SOFT <input type="checkbox"/> IXW-MA <input type="checkbox"/> IX-SPMIC <input type="checkbox"/> VoIP Phone <input checked="" type="checkbox"/> IX-DVM
Description	Send email when a storage (microSD card, PC hard disk, etc.) access error is detected. If the error is detected continuously, email will not be sent an additional time.
Settings	<ul style="list-style-type: none"> • Checked: Send • Unchecked: Do not send

■ Recording Memory Full

Compatible type	<input type="checkbox"/> IXG-2C7(-*) <input checked="" type="checkbox"/> IXG-MK <input checked="" type="checkbox"/> IX-MV7-* <input checked="" type="checkbox"/> IXG-DM7(-*) <input type="checkbox"/> IX-DA, IX-DB <input type="checkbox"/> IX-BA, IX-BB <input checked="" type="checkbox"/> IX-DV, IX-DVF(-*) <input checked="" type="checkbox"/> IX-SSA(-*) <input checked="" type="checkbox"/> IX-EA, IX-EAU <input type="checkbox"/> IX-FA <input type="checkbox"/> IXGW-LC <input type="checkbox"/> IXGW-(T)GW <input type="checkbox"/> Intercom App <input type="checkbox"/> IX-SS-2G <input type="checkbox"/> IX-RS-* <input checked="" type="checkbox"/> IX-SOFT <input type="checkbox"/> IXW-MA <input type="checkbox"/> IX-SPMIC <input type="checkbox"/> VoIP Phone <input checked="" type="checkbox"/> IX-DVM
Description	<p>Send email if the storage (microSD card, PC hard disk, etc.) experiences any of the following. If detected continuously, email will not be sent an additional time.</p> <ul style="list-style-type: none"> • For IX-SOFT <ul style="list-style-type: none"> – Recorded recordings exceeds 999 – Storage capacity remaining 5% – Storage capacity remaining 0% • If "Overwrite Protection (→page 199)" is set to "Enable" <ul style="list-style-type: none"> – Recorded recordings exceeds 950 – Storage capacity remaining 5% • If "Overwrite Protection (→page 199)" is set to "Disable" <ul style="list-style-type: none"> – Recorded recordings exceeds 999 – Storage capacity remaining 0%
Settings	<ul style="list-style-type: none"> • Checked: Send • Unchecked: Do not send

■ Line Supervision (Passed)

Compatible type	<input type="checkbox"/> IXG-2C7(-*) <input type="checkbox"/> IXG-MK <input checked="" type="checkbox"/> IX-MV7-* <input type="checkbox"/> IXG-DM7(-*) <input type="checkbox"/> IX-DA, IX-DB <input type="checkbox"/> IX-BA, IX-BB <input type="checkbox"/> IX-DV, IX-DVF(-*) <input type="checkbox"/> IX-SSA(-*) <input type="checkbox"/> IX-EA, IX-EAU <input type="checkbox"/> IX-FA <input type="checkbox"/> IXGW-LC <input type="checkbox"/> IXGW-(T)GW <input type="checkbox"/> Intercom App <input type="checkbox"/> IX-SS-2G <input type="checkbox"/> IX-RS-* <input checked="" type="checkbox"/> IX-SOFT <input type="checkbox"/> IXW-MA <input type="checkbox"/> IX-SPMIC <input type="checkbox"/> VoIP Phone <input type="checkbox"/> IX-DVM
Description	Send email when Line Supervision is "Passed."
Settings	<ul style="list-style-type: none"> • Checked: Send • Unchecked: Do not send

■ Line Supervision (Failed)

Compatible type	<input type="checkbox"/> IXG-2C7(-*) <input type="checkbox"/> IXG-MK <input checked="" type="checkbox"/> IX-MV7-* <input type="checkbox"/> IXG-DM7(-*) <input type="checkbox"/> IX-DA, IX-DB <input type="checkbox"/> IX-BA, IX-BB <input type="checkbox"/> IX-DV, IX-DVF(-*) <input type="checkbox"/> IX-SSA(-*) <input type="checkbox"/> IX-EA, IX-EAU <input type="checkbox"/> IX-FA <input type="checkbox"/> IXGW-LC <input type="checkbox"/> IXGW-(T)GW <input type="checkbox"/> Intercom App <input type="checkbox"/> IX-SS-2G <input type="checkbox"/> IX-RS-* <input checked="" type="checkbox"/> IX-SOFT <input type="checkbox"/> IXW-MA <input type="checkbox"/> IX-SPMIC <input type="checkbox"/> VoIP Phone <input type="checkbox"/> IX-DVM
Description	Send email when Line Supervision is "Failed."
Settings	<ul style="list-style-type: none"> • Checked: Send • Unchecked: Do not send

■ Device Check (Passed)

Compatible type	<input type="checkbox"/> IXG-2C7(-*) <input type="checkbox"/> IXG-MK <input checked="" type="checkbox"/> IX-MV7-* <input type="checkbox"/> IXG-DM7(-*) <input type="checkbox"/> IX-DA, IX-DB <input type="checkbox"/> IX-BA, IX-BB <input type="checkbox"/> IX-DV, IX-DVF(-*) <input type="checkbox"/> IX-SSA(-*) <input type="checkbox"/> IX-EA, IX-EAU <input type="checkbox"/> IX-FA <input type="checkbox"/> IXGW-LC <input type="checkbox"/> IXGW-(T)GW <input type="checkbox"/> Intercom App <input type="checkbox"/> IX-SS-2G <input type="checkbox"/> IX-RS-* <input checked="" type="checkbox"/> IX-SOFT <input type="checkbox"/> IXW-MA <input type="checkbox"/> IX-SPMIC <input type="checkbox"/> VoIP Phone <input type="checkbox"/> IX-DVM
Description	Send email when Device Check is "Passed."
Settings	<ul style="list-style-type: none"> • Checked: Send • Unchecked: Do not send

■ Device Check (Failed)

Compatible type	<input type="checkbox"/> IXG-2C7(-*) <input type="checkbox"/> IXG-MK <input checked="" type="checkbox"/> IX-MV7-* <input type="checkbox"/> IXG-DM7(-*) <input type="checkbox"/> IX-DA, IX-DB <input type="checkbox"/> IX-BA, IX-BB <input type="checkbox"/> IX-DV, IX-DVF(-*) <input type="checkbox"/> IX-SSA(-*) <input type="checkbox"/> IX-EA, IX-EAU <input type="checkbox"/> IX-FA <input type="checkbox"/> IXGW-LC <input type="checkbox"/> IXGW-(T)GW <input type="checkbox"/> Intercom App <input type="checkbox"/> IX-SS-2G <input type="checkbox"/> IX-RS-* <input checked="" type="checkbox"/> IX-SOFT <input type="checkbox"/> IXW-MA <input type="checkbox"/> IX-SPMIC <input type="checkbox"/> VoIP Phone <input type="checkbox"/> IX-DVM
Description	Send email when Device Check is "Failed."
Settings	<ul style="list-style-type: none"> • Checked: Send • Unchecked: Do not send

■ Subject

Compatible type	<input type="checkbox"/> IXG-2C7(-*) <input checked="" type="checkbox"/> IXG-MK <input checked="" type="checkbox"/> IX-MV7-* <input checked="" type="checkbox"/> IXG-DM7(-*) <input checked="" type="checkbox"/> IX-DA, IX-DB <input checked="" type="checkbox"/> IX-BA, IX-BB <input checked="" type="checkbox"/> IX-DV, IX-DVF(-*) <input checked="" type="checkbox"/> IX-SSA(-*) <input checked="" type="checkbox"/> IX-EA, IX-EAU <input type="checkbox"/> IX-FA <input checked="" type="checkbox"/> IXGW-LC <input type="checkbox"/> IXGW-(T)GW <input type="checkbox"/> Intercom App <input checked="" type="checkbox"/> IX-SS-2G <input checked="" type="checkbox"/> IX-RS-* <input checked="" type="checkbox"/> IX-SOFT <input checked="" type="checkbox"/> IXW-MA <input type="checkbox"/> IX-SPMIC <input type="checkbox"/> VoIP Phone <input checked="" type="checkbox"/> IX-DVM
Description	Configure the subject when sending email for each trigger. This will be used for all recipient addresses.
Settings	1-64 alphanumeric characters

Important

- [UTF-8] used for "Subject" encoding, the subject may be incorrectly decoded depending on mail server. Characters may display incorrectly depending on the email client. To avoid this, set the encoding method to "UTF-8."

How to perform Event View Selection

Select an event (Email Event Trigger) displayed on the Settings screen. The display can be filtered to show only the selected Email Event Trigger.

This will be used for all recipient addresses.

Click "Event View Selection" to display the following screen.

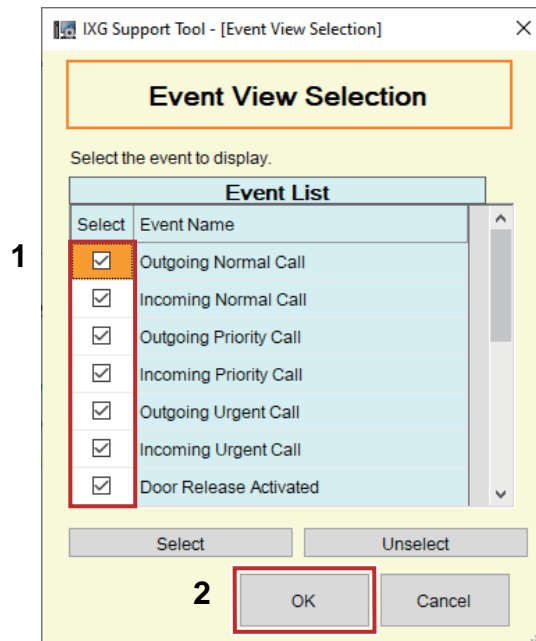

- 1.** Select the event (Email Event Trigger) from "Event List." (Multiple selections allowed.)
 - To select or unselect all events at once, click **[Select]** or **[Unselect]**.
 - By default, all events are displayed.
- 2.** Click **[OK]**.
 - Click **[Cancel]** to cancel selecting the event display.

9.3.5 Periodic Log Transmission

Configure settings related to periodic log transmission. This can be configured for each destination address.

■ Periodic Log Transmission

Compatible type	<input type="checkbox"/> IXG-2C7(-*) <input checked="" type="checkbox"/> IXG-MK <input checked="" type="checkbox"/> IX-MV7-* <input type="checkbox"/> IXG-DM7(-*) <input checked="" type="checkbox"/> IX-DA, IX-DB <input checked="" type="checkbox"/> IX-BA, IX-BB <input checked="" type="checkbox"/> IX-DV, IX-DVF(-*) <input checked="" type="checkbox"/> IX-SSA(-*) <input checked="" type="checkbox"/> IX-EA, IX-EAU <input type="checkbox"/> IX-FA <input checked="" type="checkbox"/> IXGW-LC <input type="checkbox"/> IXGW-(T)GW <input type="checkbox"/> Intercom App <input checked="" type="checkbox"/> IX-SS-2G <input checked="" type="checkbox"/> IX-RS-* <input checked="" type="checkbox"/> IX-SOFT <input checked="" type="checkbox"/> IXW-MA <input type="checkbox"/> IX-SPMIC <input type="checkbox"/> VoIP Phone <input checked="" type="checkbox"/> IX-DVM
Description	Select Enable / Disable for send station log periodically.
Settings	<ul style="list-style-type: none"> • Enable • Disable

■ Periodic Log Transmit Time

Compatible type	<input type="checkbox"/> IXG-2C7(-*) <input checked="" type="checkbox"/> IXG-MK <input checked="" type="checkbox"/> IX-MV7-* <input type="checkbox"/> IXG-DM7(-*) <input checked="" type="checkbox"/> IX-DA, IX-DB <input checked="" type="checkbox"/> IX-BA, IX-BB <input checked="" type="checkbox"/> IX-DV, IX-DVF(-*) <input checked="" type="checkbox"/> IX-SSA(-*) <input checked="" type="checkbox"/> IX-EA, IX-EAU <input type="checkbox"/> IX-FA <input checked="" type="checkbox"/> IXGW-LC <input type="checkbox"/> IXGW-(T)GW <input type="checkbox"/> Intercom App <input checked="" type="checkbox"/> IX-SS-2G <input checked="" type="checkbox"/> IX-RS-* <input checked="" type="checkbox"/> IX-SOFT <input checked="" type="checkbox"/> IXW-MA <input type="checkbox"/> IX-SPMIC <input type="checkbox"/> VoIP Phone <input checked="" type="checkbox"/> IX-DVM
Description	Set the time to send the periodic log.
Settings	00:00-23:59

■ Periodic Log Transmit Interval

Compatible type	<input type="checkbox"/> IXG-2C7(-*) <input checked="" type="checkbox"/> IXG-MK <input checked="" type="checkbox"/> IX-MV7-* <input type="checkbox"/> IXG-DM7(-*) <input checked="" type="checkbox"/> IX-DA, IX-DB <input checked="" type="checkbox"/> IX-BA, IX-BB <input checked="" type="checkbox"/> IX-DV, IX-DVF(-*) <input checked="" type="checkbox"/> IX-SSA(-*) <input checked="" type="checkbox"/> IX-EA, IX-EAU <input type="checkbox"/> IX-FA <input checked="" type="checkbox"/> IXGW-LC <input type="checkbox"/> IXGW-(T)GW <input type="checkbox"/> Intercom App <input checked="" type="checkbox"/> IX-SS-2G <input checked="" type="checkbox"/> IX-RS-* <input checked="" type="checkbox"/> IX-SOFT <input checked="" type="checkbox"/> IXW-MA <input type="checkbox"/> IX-SPMIC <input type="checkbox"/> VoIP Phone <input checked="" type="checkbox"/> IX-DVM
Description	Select the interval to send the periodic log.
Settings	1 day to 7 days

■ Periodic Log Transmission Subject

Compatible type	<input type="checkbox"/> IXG-2C7(-*) <input checked="" type="checkbox"/> IXG-MK <input checked="" type="checkbox"/> IX-MV7-* <input type="checkbox"/> IXG-DM7(-*) <input checked="" type="checkbox"/> IX-DA, IX-DB <input checked="" type="checkbox"/> IX-BA, IX-BB <input checked="" type="checkbox"/> IX-DV, IX-DVF(-*) <input checked="" type="checkbox"/> IX-SSA(-*) <input checked="" type="checkbox"/> IX-EA, IX-EAU <input type="checkbox"/> IX-FA <input checked="" type="checkbox"/> IXGW-LC <input type="checkbox"/> IXGW-(T)GW <input type="checkbox"/> Intercom App <input checked="" type="checkbox"/> IX-SS-2G <input checked="" type="checkbox"/> IX-RS-* <input checked="" type="checkbox"/> IX-SOFT <input checked="" type="checkbox"/> IXW-MA <input type="checkbox"/> IX-SPMIC <input type="checkbox"/> VoIP Phone <input checked="" type="checkbox"/> IX-DVM
Description	Configure the subject used when sending the periodic log email. This will be used for all recipient addresses.
Settings	1-64 alphanumeric characters

Important

- "UTF-8" encoding is used for the "Periodic Log Transmission Subject." Text may be displayed incorrectly depending on the email client.
If text is displayed incorrectly after receiving email, set the encoding method to "UTF-8."

9.3.6 Send Test Email

Compatible type	<input type="checkbox"/> IXG-2C7(-*) <input checked="" type="checkbox"/> IXG-MK <input checked="" type="checkbox"/> IX-MV7-* <input checked="" type="checkbox"/> IXG-DM7(-*) <input type="checkbox"/> IX-DA, IX-DB <input type="checkbox"/> IX-BA, IX-BB <input checked="" type="checkbox"/> IX-DV, IX-DVF(-*) <input checked="" type="checkbox"/> IX-SSA(-*) <input checked="" type="checkbox"/> IX-EA, IX-EAU <input type="checkbox"/> IX-FA <input checked="" type="checkbox"/> IXGW-LC <input type="checkbox"/> IXGW-(T)GW <input type="checkbox"/> Intercom App <input checked="" type="checkbox"/> IX-SS-2G <input checked="" type="checkbox"/> IX-RS-* <input checked="" type="checkbox"/> IX-SOFT <input checked="" type="checkbox"/> IXW-MA <input type="checkbox"/> IX-SPMIC <input type="checkbox"/> VoIP Phone <input checked="" type="checkbox"/> IX-DVM
-----------------	--

Send a test email to the address specified in ["Email Addresses \(→page 186\)"](#).

Click **[Send]** next to the station to which to send a test email. The following email will be sent to the configured address.

! Important

- To send a test email, "Association Settings" must have been performed in Administrator mode, and the PC must be able to communicate with the system.

Example of sending an email message

When sending a test email from the station (Station Number: 0001, Station Name: Master Station 1).

From	△△△△@△△△△△.com
Date and time	11/20/2023 15:22
To CC	xxxx@xxxxx.com
Subject	0001 Master Station 1 Test Email
Test Email sent at "20231120 15:22:46." Station Number: [0001] Station Name: [Master Station 1] Station location: [-]	

! Important

- "UTF-8" encoding is used for the "Subject," "Periodic Log Transmission Subject", and "Image Filename." Text may be displayed incorrectly depending on the email client. If text is displayed incorrectly after receiving email, set the encoding method to "UTF-8."

9.3.7 Additional Settings

■ Attach Image

Compatible type	<input type="checkbox"/> IXG-2C7(-*) <input type="checkbox"/> IXG-MK <input type="checkbox"/> IX-MV7-* <input type="checkbox"/> IXG-DM7(-*) <input checked="" type="checkbox"/> IX-DA, IX-DB <input type="checkbox"/> IX-BA, IX-BB <input checked="" type="checkbox"/> IX-DV, IX-DVF(-*) <input type="checkbox"/> IX-SSA(-*) <input checked="" type="checkbox"/> IX-EA, IX-EAU <input type="checkbox"/> IX-FA <input type="checkbox"/> IXGW-LC <input type="checkbox"/> IXGW-(T)GW <input type="checkbox"/> Intercom App <input type="checkbox"/> IX-SS-2G <input type="checkbox"/> IX-RS-* <input type="checkbox"/> IX-SOFT <input type="checkbox"/> IXW-MA <input type="checkbox"/> IX-SPMIC <input type="checkbox"/> VoIP Phone <input checked="" type="checkbox"/> IX-DVM
Description	Configure whether to attach a still image captured on camera when sending email during an Outgoing Normal Call, Outgoing Priority Call, or Outgoing Urgent Call caused by "Email Event Trigger (→page 186)" .
Settings	<ul style="list-style-type: none"> • Enable • Disable

■ Image Filename

Compatible type	<input type="checkbox"/> IXG-2C7(-*) <input type="checkbox"/> IXG-MK <input type="checkbox"/> IX-MV7-* <input type="checkbox"/> IXG-DM7(-*) <input checked="" type="checkbox"/> IX-DA, IX-DB <input type="checkbox"/> IX-BA, IX-BB <input checked="" type="checkbox"/> IX-DV, IX-DVF(-*) <input type="checkbox"/> IX-SSA(-*) <input checked="" type="checkbox"/> IX-EA, IX-EAU <input type="checkbox"/> IX-FA <input type="checkbox"/> IXGW-LC <input type="checkbox"/> IXGW-(T)GW <input type="checkbox"/> Intercom App <input type="checkbox"/> IX-SS-2G <input type="checkbox"/> IX-RS-* <input type="checkbox"/> IX-SOFT <input type="checkbox"/> IXW-MA <input type="checkbox"/> IX-SPMIC <input type="checkbox"/> VoIP Phone <input checked="" type="checkbox"/> IX-DVM
Description	Set the name of the image file to "Attach Image."
Settings	1-64 alphanumeric characters

Important

- "UTF-8" encoding is used for the "Image Filename." Text may be displayed incorrectly depending on the email client. If text is displayed incorrectly after receiving email, set the encoding method to "UTF-8."

9.4 Recording

Configure the recording settings. If there is no video, this will apply only to audio. When recording communication, any audio from the recording station will also be recorded.

A microSD card that complies with the following SD standards is required to store recordings for stations other than IX-SOFT. For IX-SOFT, this will be recorded to the storage device of the PC on which IX-SOFT is installed.

Station Type	Standard	Supported storage capacity	Format	Speed class
IXG-2C7(-*) IXG-DM7(-*) IX-EA IX-DV, IX-DVF(-*) IX-SSA(-*) IX-DVM	microSDHC memory cards	4 GB to 32 GB	FAT32	SD speed class 10 UHS speed class 1
IXG-MK IX-MV7(-*)	microSDXC memory cards	64 GB to 128 GB	exFAT	

Important

- Stations do not include microSD cards. A microSD card will need to be purchased. Select a microSD card that suits the usage environment such as temperature.
- The device may not operate correctly depending on the microSD card.
- If the card contains data except video/audio files, it may not have enough space to record video/audio.
- The network camera may not be able to record video, depending on the size of the image.

Note

- A maximum of 999 recordings can be saved. However, this may vary depending on the size of the recording files and the capacity of the microSD card or PC storage device.
- Use a microSD card that has been formatted on a PC or the like.
- A microSD card has a limited life. The microSD card should be replaced periodically. Contact the manufacturer of the microSD card for information on when the microSD card should be replaced.
- Line Supervision and Device Check results are also saved to the microSD card.
- Aiphone assumes no responsibility for microSD cards or PCs. Please keep this in mind.

Move row

Up to 50 station number rows can be displayed at a time. Switch the screen as follows.

[Previous]: Display the previous 50 rows.

[Next]: Display the next 50 rows.

[Apply]: Enter the station number and click **[Apply]** to move the cursor to the row of the station number that was entered.

Display settings

["Weekly Schedule \(→page 201\)"](#)

Move to Related Settings

Moves to the selected item within the same Settings screen.

The screenshot shows the 'Function Settings' interface. At the top, there is a control bar with the following elements:

- Row** section: Includes 'Previous', 'Next', and 'Apply' buttons, and a text input field labeled 'Enter Station Number'.
- [Display settings]** dropdown menu: Shows 'Weekly Schedule' as the selected option, with a link to 'Weekly Schedule (→page 201)'. Below it is a 'Schedule View Adjustment' button.
- [Move to Related Settings]** dropdown menu: Shows 'Recording Mode' as the selected option.

Below the control bar is a table with the following data:

Function Settings										
Building Number	Unit Number	Station Name	Recording Mode	Recording Event						Recorded Device
				Incoming Call	Communication (Master)	Monitoring	Call Origination	Communication (Door/Entrance)	When Monitored	
01	001	Entrance Station1	Disable				Disable	Disable	Disable	Disable
01	001	Entrance Station2	Disable				Disable	Disable	Disable	Disable
01	0001	Master Station1		Disable	Disable	Disable			Disable	Disable
01	101	Tenant Station1	Enable	Disable					Disable	Disable
01	101	Video Door Station1	Disable				Disable	Disable	Disable	Disable
01	102	Tenant Station1	Enable	Disable					Disable	Disable

9.4.1 Recording Mode

Compatible type	<input checked="" type="checkbox"/> IXG-2C7(-*) <input type="checkbox"/> IXG-MK <input type="checkbox"/> IX-MV7-* <input checked="" type="checkbox"/> IXG-DM7(-*) <input type="checkbox"/> IX-DA, IX-DB <input type="checkbox"/> IX-BA, IX-BB <input checked="" type="checkbox"/> IX-DV, IX-DVF(-*) <input checked="" type="checkbox"/> IX-SSA(-*) <input checked="" type="checkbox"/> IX-EA, IX-EAU <input type="checkbox"/> IX-FA <input type="checkbox"/> IXGW-LC <input type="checkbox"/> IXGW-(T)GW <input type="checkbox"/> Intercom App <input type="checkbox"/> IX-SS-2G <input type="checkbox"/> IX-RS-* <input type="checkbox"/> IX-SOFT <input type="checkbox"/> IXW-MA <input type="checkbox"/> IX-SPMIC <input type="checkbox"/> VoIP Phone <input checked="" type="checkbox"/> IX-DVM
Description	Configure the recording mode.
Settings	<ul style="list-style-type: none"> • Disable • Enable (IXG-2C7(-*) only) • Event Recording (IXG-DM7(-*), IX-DV, IX-DVF(-*), IX-SSA(-*), IX-EA, IX-DVM only): Record video/audio when the trigger set by "Recording Event" occurs. • 24/7 Recording (IXG-DM7(-*), IX-DV, IX-DVF(-*), IX-SSA(-*), IX-EA, IX-DVM only): Continuously record video/audio as long as the station is operating normally.



Note

- If the IXG-DM7(-*) setting is changed to "24/7 Recording" or if the setting is changed from "24/7 Recording," the station will restart once the setting is applied.

9.4.2 Recording Event

Configure the trigger in use to start recording video/audio automatically.

For stations other than IXG-MK, IX-MV7-*, and IX-SOFT, this is only the case if "Recording Mode" was set to "Event Recording."

■ Incoming Call

Compatible type	<input type="checkbox"/> IXG-2C7(-*) <input checked="" type="checkbox"/> IXG-MK <input checked="" type="checkbox"/> IX-MV7-* <input type="checkbox"/> IXG-DM7(-*) <input type="checkbox"/> IX-DA, IX-DB <input type="checkbox"/> IX-BA, IX-BB <input type="checkbox"/> IX-DV, IX-DVF(-*) <input type="checkbox"/> IX-SSA(-*) <input type="checkbox"/> IX-EA, IX-EAU <input type="checkbox"/> IX-FA <input type="checkbox"/> IXGW-LC <input type="checkbox"/> IXGW-(T)GW <input type="checkbox"/> Intercom App <input type="checkbox"/> IX-SS-2G <input type="checkbox"/> IX-RS-* <input checked="" type="checkbox"/> IX-SOFT <input type="checkbox"/> IXW-MA <input type="checkbox"/> IX-SPMIC <input type="checkbox"/> VoIP Phone <input type="checkbox"/> IX-DVM
Description	Begin recording video when there is an incoming call. If a call is automatically answered, begin recording video/audio when communication starts. For IXG-MK, change the setting on the screen of the station.
Settings	<ul style="list-style-type: none"> • Enable • Disable

■ Communication (Master)

Compatible type	<input type="checkbox"/> IXG-2C7(-*) <input checked="" type="checkbox"/> IXG-MK <input checked="" type="checkbox"/> IX-MV7-* <input type="checkbox"/> IXG-DM7(-*) <input type="checkbox"/> IX-DA, IX-DB <input type="checkbox"/> IX-BA, IX-BB <input type="checkbox"/> IX-DV, IX-DVF(-*) <input type="checkbox"/> IX-SSA(-*) <input type="checkbox"/> IX-EA, IX-EAU <input type="checkbox"/> IX-FA <input type="checkbox"/> IXGW-LC <input type="checkbox"/> IXGW-(T)GW <input type="checkbox"/> Intercom App <input type="checkbox"/> IX-SS-2G <input type="checkbox"/> IX-RS-* <input checked="" type="checkbox"/> IX-SOFT <input type="checkbox"/> IXW-MA <input type="checkbox"/> IX-SPMIC <input type="checkbox"/> VoIP Phone <input type="checkbox"/> IX-DVM
Description	Recording starts when communication begins. For IXG-MK, change the setting on the screen of the station.
Settings	<ul style="list-style-type: none"> • Enable • Disable

■ Monitoring

Compatible type	<input type="checkbox"/> IXG-2C7(-*) <input checked="" type="checkbox"/> IXG-MK <input checked="" type="checkbox"/> IX-MV7-* <input type="checkbox"/> IXG-DM7(-*) <input type="checkbox"/> IX-DA, IX-DB <input type="checkbox"/> IX-BA, IX-BB <input type="checkbox"/> IX-DV, IX-DVF(-*) <input type="checkbox"/> IX-SSA(-*) <input type="checkbox"/> IX-EA, IX-EAU <input type="checkbox"/> IX-FA <input type="checkbox"/> IXGW-LC <input type="checkbox"/> IXGW-(T)GW <input type="checkbox"/> Intercom App <input type="checkbox"/> IX-SS-2G <input type="checkbox"/> IX-RS-* <input checked="" type="checkbox"/> IX-SOFT <input type="checkbox"/> IXW-MA <input type="checkbox"/> IX-SPMIC <input type="checkbox"/> VoIP Phone <input type="checkbox"/> IX-DVM
Description	Begin recording video/audio when monitoring starts. Recording video/audio is not available during scan monitoring. For IXG-MK, change the setting on the screen of the station.
Settings	<ul style="list-style-type: none"> • Enable • Disable

■ Call Origination

Compatible type	<input type="checkbox"/> IXG-2C7(-*) <input type="checkbox"/> IXG-MK <input type="checkbox"/> IX-MV7-* <input checked="" type="checkbox"/> IXG-DM7(-*) <input type="checkbox"/> IX-DA, IX-DB <input type="checkbox"/> IX-BA, IX-BB <input checked="" type="checkbox"/> IX-DV, IX-DVF(-*) <input checked="" type="checkbox"/> IX-SSA(-*) <input checked="" type="checkbox"/> IX-EA, IX-EAU <input type="checkbox"/> IX-FA <input type="checkbox"/> IXGW-LC <input type="checkbox"/> IXGW-(T)GW <input type="checkbox"/> Intercom App <input type="checkbox"/> IX-SS-2G <input type="checkbox"/> IX-RS-* <input type="checkbox"/> IX-SOFT <input type="checkbox"/> IXW-MA <input type="checkbox"/> IX-SPMIC <input type="checkbox"/> VoIP Phone <input checked="" type="checkbox"/> IX-DVM
Description	IXG-DM7(-*), IX-DV, IX-DVF(-*), IX-EA, IX-DVM: Begin recording video when an outgoing call is made. Begin recording audio once communication has started after making an outgoing call. IX-SSA(-*): Begin recording audio once communication has started after an outgoing call is made.
Settings	<ul style="list-style-type: none"> • Enable • Disable

■ Communication (Door/Entrance)

Compatible type	<input type="checkbox"/> IXG-2C7(-*) <input type="checkbox"/> IXG-MK <input type="checkbox"/> IX-MV7-* <input checked="" type="checkbox"/> IXG-DM7(-*) <input type="checkbox"/> IX-DA, IX-DB <input type="checkbox"/> IX-BA, IX-BB <input checked="" type="checkbox"/> IX-DV, IX-DVF(-*) <input checked="" type="checkbox"/> IX-SSA(-*) <input checked="" type="checkbox"/> IX-EA, IX-EAU <input type="checkbox"/> IX-FA <input type="checkbox"/> IXGW-LC <input type="checkbox"/> IXGW-(T)GW <input type="checkbox"/> Intercom App <input type="checkbox"/> IX-SS-2G <input type="checkbox"/> IX-RS-* <input type="checkbox"/> IX-SOFT <input type="checkbox"/> IXW-MA <input type="checkbox"/> IX-SPMIC <input type="checkbox"/> VoIP Phone <input checked="" type="checkbox"/> IX-DVM
Description	Recording starts when communication begins.
Settings	<ul style="list-style-type: none"> • Enable • Disable

■ When Monitored

Compatible type	<input type="checkbox"/> IXG-2C7(-*) <input type="checkbox"/> IXG-MK <input type="checkbox"/> IX-MV7-* <input checked="" type="checkbox"/> IXG-DM7(-*) <input type="checkbox"/> IX-DA, IX-DB <input type="checkbox"/> IX-BA, IX-BB <input checked="" type="checkbox"/> IX-DV, IX-DVF(-*) <input checked="" type="checkbox"/> IX-SSA(-*) <input checked="" type="checkbox"/> IX-EA, IX-EAU <input type="checkbox"/> IX-FA <input type="checkbox"/> IXGW-LC <input type="checkbox"/> IXGW-(T)GW <input type="checkbox"/> Intercom App <input type="checkbox"/> IX-SS-2G <input type="checkbox"/> IX-RS-* <input type="checkbox"/> IX-SOFT <input type="checkbox"/> IXW-MA <input type="checkbox"/> IX-SPMIC <input type="checkbox"/> VoIP Phone <input checked="" type="checkbox"/> IX-DVM
Description	Recording starts when station is Monitored. Recording video/audio is not available during scan monitoring.
Settings	<ul style="list-style-type: none"> • Enable • Disable

■ Schedule

Compatible type	<input type="checkbox"/> IXG-2C7(-*) <input type="checkbox"/> IXG-MK <input type="checkbox"/> IX-MV7-* <input checked="" type="checkbox"/> IXG-DM7(-*) <input type="checkbox"/> IX-DA, IX-DB <input type="checkbox"/> IX-BA, IX-BB <input checked="" type="checkbox"/> IX-DV, IX-DVF(-*) <input checked="" type="checkbox"/> IX-SSA(-*) <input checked="" type="checkbox"/> IX-EA, IX-EAU <input type="checkbox"/> IX-FA <input type="checkbox"/> IXGW-LC <input type="checkbox"/> IXGW-(T)GW <input type="checkbox"/> Intercom App <input type="checkbox"/> IX-SS-2G <input type="checkbox"/> IX-RS-* <input type="checkbox"/> IX-SOFT <input type="checkbox"/> IXW-MA <input type="checkbox"/> IX-SPMIC <input type="checkbox"/> VoIP Phone <input checked="" type="checkbox"/> IX-DVM
Description	Record during schedule set in " Weekly Schedule (→page 201) ".
Settings	<ul style="list-style-type: none"> • Enable • Disable

! Important

- Video/audio recording will continue for the time set in ["Weekly Schedule \(→page 201\)"](#), regardless of what is configured for other triggers.

9.4.3 Recorded Device

Compatible type	<input type="checkbox"/> IXG-2C7(-*) <input checked="" type="checkbox"/> IXG-MK <input checked="" type="checkbox"/> IX-MV7-* <input type="checkbox"/> IXG-DM7(-*) <input type="checkbox"/> IX-DA, IX-DB <input type="checkbox"/> IX-BA, IX-BB <input type="checkbox"/> IX-DV, IX-DVF(-*) <input type="checkbox"/> IX-SSA(-*) <input type="checkbox"/> IX-EA, IX-EAU <input type="checkbox"/> IX-FA <input type="checkbox"/> IXGW-LC <input type="checkbox"/> IXGW-(T)GW <input type="checkbox"/> Intercom App <input type="checkbox"/> IX-SS-2G <input type="checkbox"/> IX-RS-* <input checked="" type="checkbox"/> IX-SOFT <input type="checkbox"/> IXW-MA <input type="checkbox"/> IX-SPMIC <input type="checkbox"/> VoIP Phone <input type="checkbox"/> IX-DVM
Description	Configure which video to record if the IX, IXG System station video and network camera video are displayed on two screens.
Settings	<ul style="list-style-type: none"> • IX, IXG Station: Record video from the IX, IXG system station. • Network Camera: Record video from the network camera.

9.4.4 Overwrite Protection

Compatible type	<input checked="" type="checkbox"/> IXG-2C7(-*) <input checked="" type="checkbox"/> IXG-MK <input checked="" type="checkbox"/> IX-MV7-* <input checked="" type="checkbox"/> IXG-DM7(-*) <input type="checkbox"/> IX-DA, IX-DB <input type="checkbox"/> IX-BA, IX-BB <input checked="" type="checkbox"/> IX-DV, IX-DVF(-*) <input checked="" type="checkbox"/> IX-SSA(-*) <input checked="" type="checkbox"/> IX-EA IX-EAU <input type="checkbox"/> IX-FA <input type="checkbox"/> IXGW-LC <input type="checkbox"/> IXGW-(T)GW <input type="checkbox"/> Intercom App <input type="checkbox"/> IX-SS-2G <input type="checkbox"/> IX-RS-* <input type="checkbox"/> IX-SOFT <input type="checkbox"/> IXW-MA <input type="checkbox"/> IX-SPMIC <input type="checkbox"/> VoIP Phone <input checked="" type="checkbox"/> IX-DVM
Description	Set prevent overwriting the old recorded file, when the number of saved video/audio files, the entire storage space of the microSD card, or the video/audio recording storage space of the microSD card is full.
Settings	<ul style="list-style-type: none"> • Enable • Disable IXG-2C7(-*) is set to "Disable" and cannot be changed. For IXG-MK, change the setting on the screen of the station.

9.4.5 Video Recording File Length

Compatible type	<input checked="" type="checkbox"/> IXG-2C7(-*) <input checked="" type="checkbox"/> IXG-MK <input checked="" type="checkbox"/> IX-MV7-* <input checked="" type="checkbox"/> IXG-DM7(-*) <input type="checkbox"/> IX-DA, IX-DB <input type="checkbox"/> IX-BA, IX-BB <input checked="" type="checkbox"/> IX-DV, IX-DVF(-*) <input checked="" type="checkbox"/> IX-SSA(-*) <input checked="" type="checkbox"/> IX-EA IX-EAU <input type="checkbox"/> IX-FA <input type="checkbox"/> IXGW-LC <input type="checkbox"/> IXGW-(T)GW <input type="checkbox"/> Intercom App <input type="checkbox"/> IX-SS-2G <input type="checkbox"/> IX-RS-* <input checked="" type="checkbox"/> IX-SOFT <input type="checkbox"/> IXW-MA <input type="checkbox"/> IX-SPMIC <input type="checkbox"/> VoIP Phone <input checked="" type="checkbox"/> IX-DVM
Description	Select the recording file length to split recording. Once recording has reached this time, a new recording file will be made automatically.
Settings	<ul style="list-style-type: none"> • 5 min • 10 min • 20 min • 40 min • 60 min IXG-2C7(-*) is set to "10 min" and cannot be changed.

💡 Note

- If the Video Recording File Length is changed during recording video/audio, the setting will not be applied until the recording is completed.

9.4.6 Event Recording Timer

Compatible type	<input checked="" type="checkbox"/> IXG-2C7(-*) <input checked="" type="checkbox"/> IXG-MK <input checked="" type="checkbox"/> IX-MV7-* <input type="checkbox"/> IXG-DM7(-*) <input type="checkbox"/> IX-DA, IX-DB <input type="checkbox"/> IX-BA, IX-BB <input type="checkbox"/> IX-DV, IX-DVF(-*) <input type="checkbox"/> IX-SSA(-*) <input type="checkbox"/> IX-EA IX-EAU <input type="checkbox"/> IX-FA <input type="checkbox"/> IXGW-LC <input type="checkbox"/> IXGW-(T)GW <input type="checkbox"/> Intercom App <input type="checkbox"/> IX-SS-2G <input type="checkbox"/> IX-RS-* <input checked="" type="checkbox"/> IX-SOFT <input type="checkbox"/> IXW-MA <input type="checkbox"/> IX-SPMIC <input type="checkbox"/> VoIP Phone <input type="checkbox"/> IX-DVM
Description	Set the recording duration when the event trigger has occurred.
Settings	<ul style="list-style-type: none"> • Disable: Do not stop until the operating status ends or the record video button is touched. • 5 sec • 10 sec • 30 sec IXG-2C7(-*) is set to "Disable" and cannot be changed. For IXG-MK, change the setting on the screen of the station.

9.4.7 Manual Recording

Compatible type	<input checked="" type="checkbox"/> IXG-2C7(-*) <input checked="" type="checkbox"/> IXG-MK <input checked="" type="checkbox"/> IX-MV7-* <input type="checkbox"/> IXG-DM7(-*) <input type="checkbox"/> IX-DA, IX-DB <input type="checkbox"/> IX-BA, IX-BB <input type="checkbox"/> IX-DV, IX-DVF(-*) <input type="checkbox"/> IX-SSA(-*) <input type="checkbox"/> IX-EA IX-EAU <input type="checkbox"/> IX-FA <input type="checkbox"/> IXGW-LC <input type="checkbox"/> IXGW-(T)GW <input type="checkbox"/> Intercom App <input type="checkbox"/> IX-SS-2G <input type="checkbox"/> IX-RS-* <input checked="" type="checkbox"/> IX-SOFT <input type="checkbox"/> IXW-MA <input type="checkbox"/> IX-SPMIC <input type="checkbox"/> VoIP Phone <input type="checkbox"/> IX-DVM
Description	Select Enable / Disable for manual recording.
Settings	<ul style="list-style-type: none"> • Enable • Disable IXG-2C7(-*) is set to "Enable" and cannot be changed. For IXG-MK, change the setting on the screen of the station.

9.4.8 Audio Recording

Compatible type	<input checked="" type="checkbox"/> IXG-2C7(-*) <input checked="" type="checkbox"/> IXG-MK <input checked="" type="checkbox"/> IX-MV7-* <input checked="" type="checkbox"/> IXG-DM7(-*) <input type="checkbox"/> IX-DA, IX-DB <input type="checkbox"/> IX-BA, IX-BB <input checked="" type="checkbox"/> IX-DV, IX-DVF(-*) <input type="checkbox"/> IX-SSA(-*) <input checked="" type="checkbox"/> IX-EA, IX-EAU <input type="checkbox"/> IX-FA <input type="checkbox"/> IXGW-LC <input type="checkbox"/> IXGW-(T)GW <input type="checkbox"/> Intercom App <input type="checkbox"/> IX-SS-2G <input type="checkbox"/> IX-RS-* <input checked="" type="checkbox"/> IX-SOFT <input type="checkbox"/> IXW-MA <input type="checkbox"/> IX-SPMIC <input type="checkbox"/> VoIP Phone <input checked="" type="checkbox"/> IX-DVM
Description	Select Enable / Disable for audio recording with video.
Settings	<ul style="list-style-type: none"> • Enable • Disable IXG-2C7(-*) is set to "Enable" and cannot be changed.

9.4.9 Weekly Schedule

Configure this if "Recording Event" - "[Schedule \(→page 198\)](#)" was set to "Enable."

Configure the time to record video/audio for each day of the week from Sunday through Saturday. 12 schedules can be set for each day.

Move row

Up to 50 station number rows can be displayed at a time. Switch the screen as follows.

[Previous]: Display the previous 50 rows.

[Next]: Display the next 50 rows.

[Apply]: Enter the station number and click **[Apply]** to move the cursor to the row of the station number that was entered.

Weekly schedule

Select the day of week and schedule range to configure to display on the Settings screen.

["How to perform Schedule View Adjustment \(→page 202\)"](#)

■ Start Time

Compatible type	<input type="checkbox"/> IXG-2C7(-*) <input type="checkbox"/> IXG-MK <input type="checkbox"/> IX-MV7-* <input checked="" type="checkbox"/> IXG-DM7(-*) <input type="checkbox"/> IX-DA, IX-DB <input type="checkbox"/> IX-BA, IX-BB <input checked="" type="checkbox"/> IX-DV, IX-DVF(-*) <input checked="" type="checkbox"/> IX-SSA(-*) <input checked="" type="checkbox"/> IX-EA, IX-EAU <input type="checkbox"/> IX-FA <input type="checkbox"/> IXGW-LC <input type="checkbox"/> IXGW-(T)GW <input type="checkbox"/> Intercom App <input type="checkbox"/> IX-SS-2G <input type="checkbox"/> IX-RS-* <input type="checkbox"/> IX-SOFT <input type="checkbox"/> IXW-MA <input type="checkbox"/> IX-SPMIC <input type="checkbox"/> VoIP Phone <input checked="" type="checkbox"/> IX-DVM
Description	Set the Start Time to begin recording.
Settings	00:00-23:59

■ End Time

Compatible type	<input type="checkbox"/> IXG-2C7(-*) <input type="checkbox"/> IXG-MK <input type="checkbox"/> IX-MV7-* <input checked="" type="checkbox"/> IXG-DM7(-*) <input type="checkbox"/> IX-DA, IX-DB <input type="checkbox"/> IX-BA, IX-BB <input checked="" type="checkbox"/> IX-DV, IX-DVF(-*) <input checked="" type="checkbox"/> IX-SSA(-*) <input checked="" type="checkbox"/> IX-EA, IX-EAU <input type="checkbox"/> IX-FA <input type="checkbox"/> IXGW-LC <input type="checkbox"/> IXGW-(T)GW <input type="checkbox"/> Intercom App <input type="checkbox"/> IX-SS-2G <input type="checkbox"/> IX-RS-* <input type="checkbox"/> IX-SOFT <input type="checkbox"/> IXW-MA <input type="checkbox"/> IX-SPMIC <input type="checkbox"/> VoIP Phone <input checked="" type="checkbox"/> IX-DVM
Description	Configure the time when video/audio recording ends. If this is set earlier than "Start Time," the end time will be that time on the following day.
Settings	00:00-23:59

How to perform Schedule View Adjustment

Configure the day and schedule range shown on the Settings screen for the weekly schedule.

The display can be filtered to show only the day and schedule to configure.

Click "Schedule View Adjustment" to display the following screen.

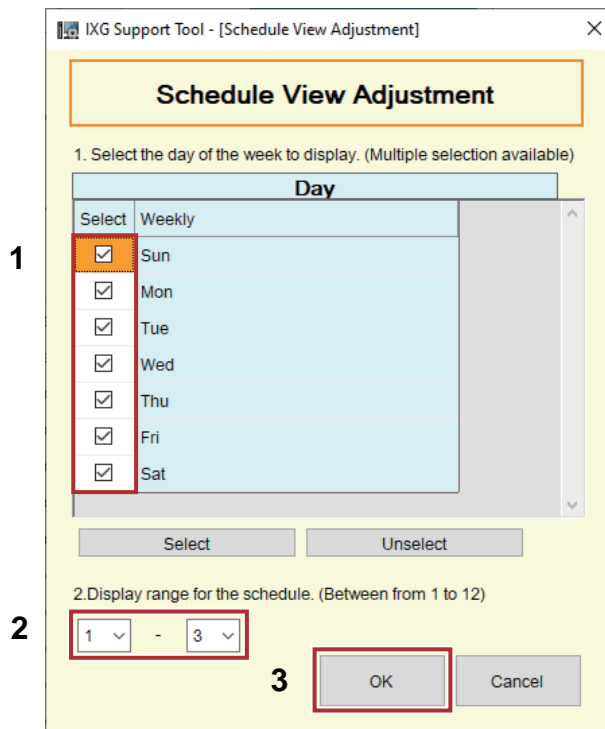

1. Select the day of week to display from "Day." (Multiple selections allowed.)
 - To select or unselect all days of the week at once, click **[Select]** or **[Unselect]**.
 - By default, all days are shown.
2. Select the range of schedules to display (1 to 12) that can be configured for each day of week.
 - By default, the range of 1 - 3 is displayed.
3. Click **[OK]**.
 - Click **[Cancel]** to cancel configuring the schedule display.

9.5 Communication Audio Messages

Configure communication audio message.

Communication Audio Messages: This function transmits the location and other such messages to the destination station when communication starts or when receiving a code from the destination station (excluding phones) via keypad operation.

Move row

Up to 50 station number rows can be displayed at a time. Switch the screen as follows.

[Previous]: Display the previous 50 rows.

[Next]: Display the next 50 rows.

[Apply]: Enter the station number and click **[Apply]** to move the cursor to the row of the station number that was entered.

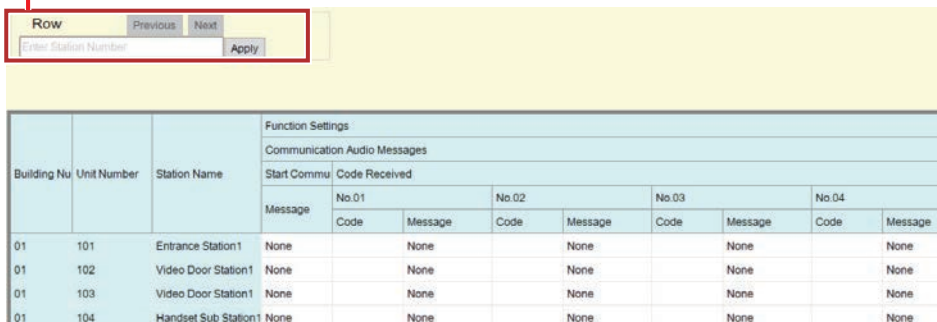

9.5.1 Start Communication

Message

Compatible type	<input type="checkbox"/> IXG-2C7(-*) <input type="checkbox"/> IXG-MK <input type="checkbox"/> IX-MV7-* <input checked="" type="checkbox"/> IXG-DM7(-*) <input type="checkbox"/> IX-DA, IX-DB <input type="checkbox"/> IX-BA, IX-BB <input checked="" type="checkbox"/> IX-DV, IX-DVF(-*) <input checked="" type="checkbox"/> IX-SSA(-*) <input checked="" type="checkbox"/> IX-EA, IX-EAU <input type="checkbox"/> IX-FA <input type="checkbox"/> IXGW-LC <input type="checkbox"/> IXGW-(T)GW <input type="checkbox"/> Intercom App <input checked="" type="checkbox"/> IX-SS-2G <input checked="" type="checkbox"/> IX-RS-* <input type="checkbox"/> IX-SOFT <input type="checkbox"/> IXW-MA <input type="checkbox"/> IX-SPMIC <input type="checkbox"/> VoIP Phone <input checked="" type="checkbox"/> IX-DVM
Description	Select the message to be sent to destination station when beginning communication.
Settings	<ul style="list-style-type: none"> • None • Call Pattern 1 • Call Pattern 2 • Call Pattern 3 • Call Pattern 4 • Call Pattern 5 • Call Pattern 6 • Call Pattern 7 (IX-EA and IX-DVM only) • Tremolo Sound • Busy Response Tone • On Hold • Operation Sound • Error • Pre Tone 1 • Pre Tone 2 • Pre Tone 3 • Communication End Pretone • Call Queue Notification • Waiting Reply Tone • Select a sound that is registered in “Custom Sound Registry (→page 117)”.

9.5.2 Code Received

Configure the message to send when the code is received. 4 patterns can be set for the received Code and message.

■ Code

Compatible type	<input type="checkbox"/> IXG-2C7(-*) <input type="checkbox"/> IXG-MK <input type="checkbox"/> IX-MV7-* <input checked="" type="checkbox"/> IXG-DM7(-*) <input type="checkbox"/> IX-DA, IX-DB <input type="checkbox"/> IX-BA, IX-BB <input checked="" type="checkbox"/> IX-DV, IX-DVF(-*) <input checked="" type="checkbox"/> IX-SSA(-*) <input checked="" type="checkbox"/> IX-EA, IX-EAU <input type="checkbox"/> IX-FA <input type="checkbox"/> IXGW-LC <input type="checkbox"/> IXGW-(T)GW <input type="checkbox"/> Intercom App <input checked="" type="checkbox"/> IX-SS-2G <input checked="" type="checkbox"/> IX-RS-* <input type="checkbox"/> IX-SOFT <input type="checkbox"/> IXW-MA <input type="checkbox"/> IX-SPMIC <input type="checkbox"/> VoIP Phone <input checked="" type="checkbox"/> IX-DVM
Description	Configure the Code that authenticates commands entered using the keypad from IX-MV7-*, IX-SOFT, or IXG-MK.
Settings	1-20 digits



Note

- If operating the keypad, enter "***Code*" here. (If the Code is "0000," enter "***0000*" here.)

■ Message

Compatible type	<input type="checkbox"/> IXG-2C7(-*) <input type="checkbox"/> IXG-MK <input type="checkbox"/> IX-MV7-* <input checked="" type="checkbox"/> IXG-DM7(-*) <input type="checkbox"/> IX-DA, IX-DB <input type="checkbox"/> IX-BA, IX-BB <input checked="" type="checkbox"/> IX-DV, IX-DVF(-*) <input checked="" type="checkbox"/> IX-SSA(-*) <input checked="" type="checkbox"/> IX-EA, IX-EAU <input type="checkbox"/> IX-FA <input type="checkbox"/> IXGW-LC <input type="checkbox"/> IXGW-(T)GW <input type="checkbox"/> Intercom App <input checked="" type="checkbox"/> IX-SS-2G <input checked="" type="checkbox"/> IX-RS-* <input type="checkbox"/> IX-SOFT <input type="checkbox"/> IXW-MA <input type="checkbox"/> IX-SPMIC <input type="checkbox"/> VoIP Phone <input checked="" type="checkbox"/> IX-DVM
Description	Configure the message sent when key input from IX-MV7-*, IX-SOFT, or IXG-MK is authenticated.
Settings	<ul style="list-style-type: none"> • None • Call Pattern 1 • Call Pattern 2 • Call Pattern 3 • Call Pattern 4 • Call Pattern 5 • Call Pattern 6 • Call Pattern 7 (IX-EA and IX-DVM only) • Tremolo Sound • Busy Response Tone • On Hold • Operation Sound • Error • Pre Tone 1 • Pre Tone 2 • Pre Tone 3 • Communication End Pretone • Call Queue Notification • Waiting Reply Tone • Select a sound that is registered in "Custom Sound Registry (→page 117)".

9.6 Chime

Configure the chime tone to be played from the station linked with the set schedule.
For IXG-MK, change the setting on the screen of the station.

Move row

Up to 50 station number rows can be displayed at a time. Switch the screen as follows.

[Previous]: Display the previous 50 rows.

[Next]: Display the next 50 rows.

[Apply]: Enter the station number and click **[Apply]** to move the cursor to the row of the station number that was entered.

Weekly Schedule

Select the day of week and schedule range to configure to display on the Settings screen.

[“How to perform Schedule View Adjustment \(→page 206\)”](#)

[“Daily Schedule \(→page 207\)”](#)

Move to Related Settings

Moves to the selected item within the same Settings screen.

The screenshot shows the Chime settings interface. At the top, there are several control elements: a 'Row' section with 'Previous', 'Next', and 'Apply' buttons; a 'Display settings' section with 'Weekly Schedule' and 'Schedule View Adjustment' options; a 'Daily Schedule' section with a date selector (8/17/2023) and a 'Display Range' section with '1' and '3' values; and a 'Move to Related Settings' section with a dropdown menu showing 'Sun'. Below these controls is a table with columns for 'Building Number', 'Unit Number', 'Station Name', and 'Function Settings'. The 'Function Settings' section is expanded to show 'Chime' settings for each day of the week (Sun 01, Sun 02, Sun 03, Mon 01, Mon 02, Mon 03). Each day's settings include 'Start Time' and 'Chime' columns. The table shows various stations with their respective chime settings, mostly set to 'None'.

9.6.1 Weekly Schedule

Configure the start time and the chime tone for every day from Sunday through Saturday.
50 schedules can be set for each day.

Start Time

Compatible type	<input type="checkbox"/> IXG-2C7(-*) <input type="checkbox"/> IXG-MK <input checked="" type="checkbox"/> IX-MV7-* <input type="checkbox"/> IXG-DM7(-*) <input type="checkbox"/> IX-DA, IX-DB <input type="checkbox"/> IX-BA, IX-BB <input checked="" type="checkbox"/> IX-DV, IX-DVF(-*) <input checked="" type="checkbox"/> IX-SSA(-*) <input checked="" type="checkbox"/> IX-EA, IX-EAU <input type="checkbox"/> IX-FA <input type="checkbox"/> IXGW-LC <input type="checkbox"/> IXGW-(T)GW <input type="checkbox"/> Intercom App <input checked="" type="checkbox"/> IX-SS-2G <input checked="" type="checkbox"/> IX-RS-* <input type="checkbox"/> IX-SOFT <input type="checkbox"/> IXW-MA <input type="checkbox"/> IX-SPMIC <input type="checkbox"/> VoIP Phone <input checked="" type="checkbox"/> IX-DVM
Description	Set the Time to ring Chime.
Settings	00:00-23:59

■ Chime

Compatible type	<input type="checkbox"/> IXG-2C7(-*) <input type="checkbox"/> IXG-MK <input checked="" type="checkbox"/> IX-MV7-* <input type="checkbox"/> IXG-DM7(-*) <input type="checkbox"/> IX-DA, IX-DB <input type="checkbox"/> IX-BA, IX-BB <input checked="" type="checkbox"/> IX-DV, IX-DVF(-*) <input checked="" type="checkbox"/> IX-SSA(-*) <input checked="" type="checkbox"/> IX-EA, IX-EAU <input type="checkbox"/> IX-FA <input type="checkbox"/> IXGW-LC <input type="checkbox"/> IXGW-(T)GW <input type="checkbox"/> Intercom App <input checked="" type="checkbox"/> IX-SS-2G <input checked="" type="checkbox"/> IX-RS-* <input type="checkbox"/> IX-SOFT <input type="checkbox"/> IXW-MA <input type="checkbox"/> IX-SPMIC <input type="checkbox"/> VoIP Phone <input checked="" type="checkbox"/> IX-DVM
Description	Set the sound for chime.
Settings	<ul style="list-style-type: none"> • None • Call Pattern 1 • Call Pattern 2 • Call Pattern 3 • Call Pattern 4 • Call Pattern 5 • Call Pattern 6 • Call Pattern 7 (IX-EA and IX-DVM only) • Tremolo Sound • Busy Response Tone • On Hold • Operation Sound • Error • Pre Tone 1 • Pre Tone 2 • Pre Tone 3 • Communication End Pretone • Call Queue Notification • Waiting Reply Tone • Select a sound that is registered in "Custom Sound Registry (→page 117)".

How to perform Schedule View Adjustment

Configure the day and schedule range shown on the Settings screen for the weekly schedule. The display can be filtered to show only the day and schedule to configure. Click "Schedule View Adjustment" to display the following screen.

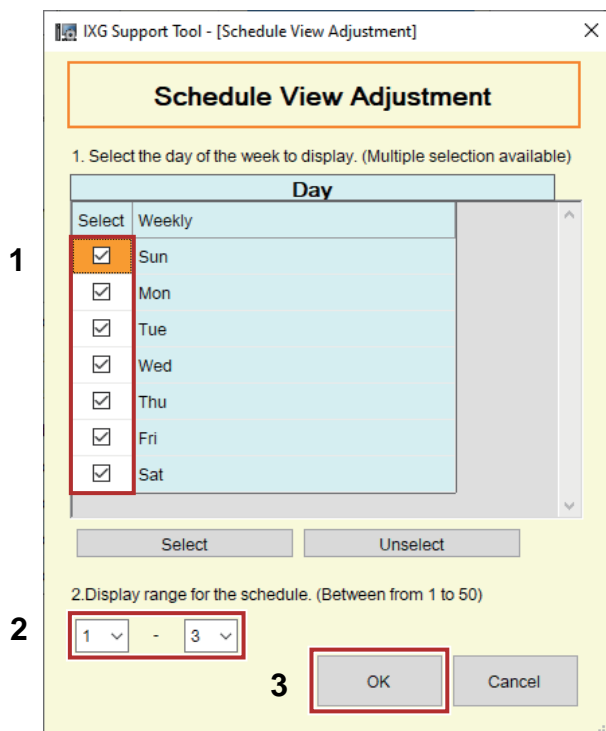

1. Select the day of week to display from "Day." (Multiple selections allowed.)
 - To select or unselect all days of the week at once, click **[Select]** or **[Unselect]**.
 - By default, all days are shown.

2. Select the range of schedules to display (1 to 50) that can be configured for each day of week.
 - By default, the range of 1 - 3 is displayed.
3. Click **[OK]**.
 - Click **[Cancel]** to cancel configuring the schedule display.

9.6.2 Daily Schedule

Configure the start time and the chime tone in units of one day.

A schedule to the end of the month one year from the set day can be configured. 50 schedules can be set for each day.

Move row

Up to 50 station number rows can be displayed at a time. Switch the screen as follows.

[Previous]: Display the previous 50 rows.

[Next]: Display the next 50 rows.

[Apply]: Enter the station number and click

[Apply] to move the cursor to the row of the station number that was entered.

Daily Schedule

Select the date and schedule range to configure. The Settings screen is displayed.

1. Select the date from the drop down menu.
2. Select the range of schedules to display (1 to 50) that can be configured for each day.
 - By default, the range of 1 - 3 is displayed.
3. Click **[Change to Daily Schedule Display]**.

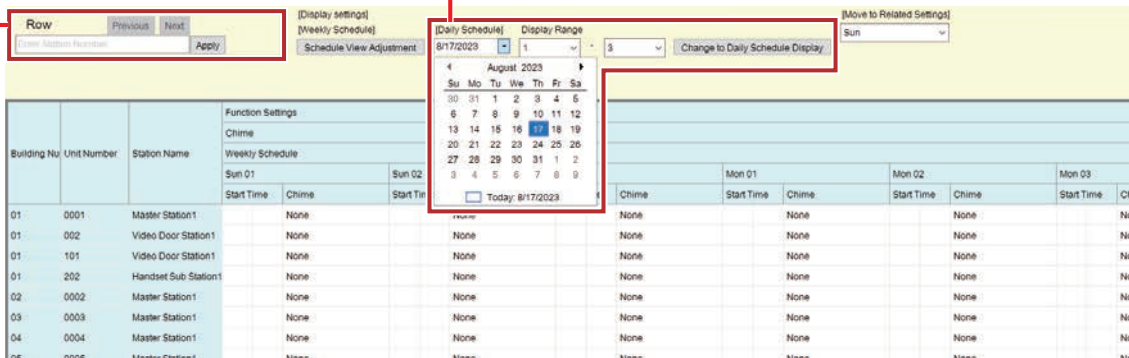

Start Time

Compatible type	<input type="checkbox"/> IXG-2C7(-*) <input type="checkbox"/> IXG-MK <input checked="" type="checkbox"/> IX-MV7-* <input type="checkbox"/> IXG-DM7(-*) <input type="checkbox"/> IX-DA, IX-DB <input type="checkbox"/> IX-BA, IX-BB <input checked="" type="checkbox"/> IX-DV, IX-DVF(-*) <input checked="" type="checkbox"/> IX-SSA(-*) <input checked="" type="checkbox"/> IX-EA, IX-EAU <input type="checkbox"/> IX-FA <input type="checkbox"/> IXGW-LC <input type="checkbox"/> IXGW-(T)GW <input type="checkbox"/> Intercom App <input checked="" type="checkbox"/> IX-SS-2G <input checked="" type="checkbox"/> IX-RS-* <input type="checkbox"/> IX-SOFT <input type="checkbox"/> IXW-MA <input type="checkbox"/> IX-SPMIC <input type="checkbox"/> VoIP Phone <input checked="" type="checkbox"/> IX-DVM
Description	Set the Time to ring Chime.
Settings	00:00-23:59

■ Chime

Compatible type	<input type="checkbox"/> IXG-2C7(-*) <input type="checkbox"/> IXG-MK <input checked="" type="checkbox"/> IX-MV7-* <input type="checkbox"/> IXG-DM7(-*) <input type="checkbox"/> IX-DA, IX-DB <input type="checkbox"/> IX-BA, IX-BB <input checked="" type="checkbox"/> IX-DV, IX-DVF(-*) <input checked="" type="checkbox"/> IX-SSA(-*) <input checked="" type="checkbox"/> IX-EA, IX-EAU <input type="checkbox"/> IX-FA <input type="checkbox"/> IXGW-LC <input type="checkbox"/> IXGW-(T)GW <input type="checkbox"/> Intercom App <input checked="" type="checkbox"/> IX-SS-2G <input checked="" type="checkbox"/> IX-RS-* <input type="checkbox"/> IX-SOFT <input type="checkbox"/> IXW-MA <input type="checkbox"/> IX-SPMIC <input type="checkbox"/> VoIP Phone <input checked="" type="checkbox"/> IX-DVM
Description	Set the sound for chime.
Settings	<ul style="list-style-type: none"> • None • Call Pattern 1 • Call Pattern 2 • Call Pattern 3 • Call Pattern 4 • Call Pattern 5 • Call Pattern 6 • Call Pattern 7 (IX-EA and IX-DVM only) • Tremolo Sound • Busy Response Tone • On Hold • Operation Sound • Error • Pre Tone 1 • Pre Tone 2 • Pre Tone 3 • Communication End Pretone • Call Queue Notification • Waiting Reply Tone • Select a sound that is registered in “Custom Sound Registry (→page 117)”.

9.7 Display Mode

Configure the screen display for IXG-MK, IX-MV7(-*), or IXG-2C7(-*).

! Important

- If a schedule set in the "Weekly Schedule" and the "Holiday Schedule" overlap, the "Holiday Schedule" setting takes precedence.

Move row

Up to 50 station number rows can be displayed at a time. Switch the screen as follows.

[Previous]: Display the previous 50 rows.

[Next]: Display the next 50 rows.

[Apply]: Enter the station number and click **[Apply]** to move the cursor to the row of the station number that was entered.

Move to Related Settings

Moves to the selected item within the same Settings screen.

The screenshot shows a settings interface with a yellow header bar. On the left, there is a 'Row' control with 'Previous' and 'Next' buttons, an input field for 'Enter Station Number', and an 'Apply' button. To its right is a dropdown menu labeled '(Move to Related Settings)' with 'Master UI Mode' selected. Below these is a table with columns: Building Nu, Unit Number, Station Name, Function Settings, Display Mode, Receptionist Mode, and Company Information. The table contains two rows of data for Tenant Station 1.

Building Nu	Unit Number	Station Name	Function Settings									
			Display Mode			Receptionist Mode						
			Master UI Mod	Home Screen	Automatic Entry Bu	Reception Mode B	Color Scher	Screen Layout	Company Information			
									Name	Text Size	Bold	Text Color
01	102	Tenant Station 1	Standard	Option 1	Disable		Light	Layout 1		12	Normal	Option 1
01	103	Tenant Station 1	Standard	Option 1	Disable		Light	Layout 1		12	Normal	Option 1

9.7.1 Master UI Mode

Compatible type	<input checked="" type="checkbox"/> IXG-2C7(-*) <input checked="" type="checkbox"/> IXG-MK <input checked="" type="checkbox"/> IX-MV7-* <input type="checkbox"/> IXG-DM7(-*) <input type="checkbox"/> IX-DA, IX-DB <input type="checkbox"/> IX-BA, IX-BB <input type="checkbox"/> IX-DV, IX-DVF(-*) <input type="checkbox"/> IX-SSA(-*) <input type="checkbox"/> IX-EA, IX-EAU <input type="checkbox"/> IX-FA <input type="checkbox"/> IXGW-LC <input type="checkbox"/> IXGW-(T)GW <input type="checkbox"/> Intercom App <input type="checkbox"/> IX-SS-2G <input type="checkbox"/> IX-RS-* <input type="checkbox"/> IX-SOFT <input type="checkbox"/> IXW-MA <input type="checkbox"/> IX-SPMIC <input type="checkbox"/> VoIP Phone <input type="checkbox"/> IX-DVM
Description	Set the User Interface Mode.
Settings	<ul style="list-style-type: none"> • Standard: All functions can be used, such as paging and history confirmation. • Receptionist: Only the outgoing call function can be used. Refer to "Receptionist Mode (→page 211)" for advanced settings. IXG-2C7(-*) and IXG-MK are set to "Standard" and cannot be changed.

! Important

- When the "Master UI Mode" setting is applied to the station, it will restart. In some cases, it may take up to 10 minutes to restart. The station will be inoperable until it has finished restarting.

9.7.2 Standard Mode

■ Home Screen

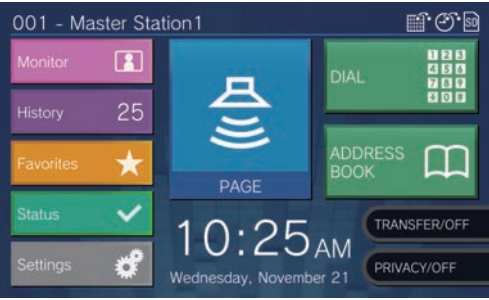
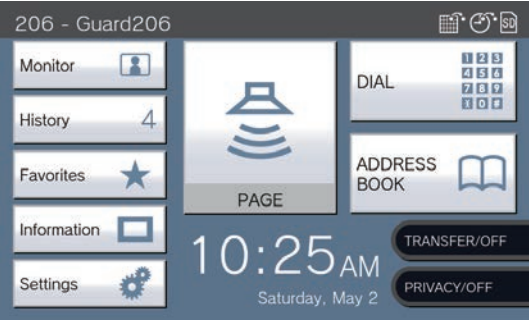
<p>Compatible type</p>	<p><input checked="" type="checkbox"/>IXG-2C7(-*) <input checked="" type="checkbox"/>IXG-MK <input checked="" type="checkbox"/>IX-MV7-* <input type="checkbox"/>IXG-DM7(-*) <input type="checkbox"/>IX-DA, IX-DB <input type="checkbox"/>IX-BA, IX-BB <input type="checkbox"/>IX-DV, IX-DVF(-*) <input type="checkbox"/>IX-SSA(-*) <input type="checkbox"/>IX-EA, IX-EAU <input type="checkbox"/>IX-FA <input type="checkbox"/>IXGW-LC <input type="checkbox"/>IXGW-(T)GW <input type="checkbox"/>Intercom App <input type="checkbox"/>IX-SS-2G <input type="checkbox"/>IX-RS-* <input type="checkbox"/>IX-SOFT <input type="checkbox"/>IXW-MA <input type="checkbox"/>IX-SPMIC <input type="checkbox"/>VoIP Phone <input type="checkbox"/>IX-DVM</p>
<p>Description</p>	<p>If "Master UI Mode (→page 209)" was set to "Standard," configure the main screen.</p>
<p>Settings</p>	<ul style="list-style-type: none"> Option 1: <div style="display: flex; flex-direction: column; align-items: center;">   </div> Option 2: <div style="display: flex; flex-direction: column; align-items: center;">   </div>

■ Automatic Entry Button

Compatible type	<input checked="" type="checkbox"/> IXG-2C7(-*) <input type="checkbox"/> IXG-MK <input type="checkbox"/> IX-MV7-* <input type="checkbox"/> IXG-DM7(-*) <input type="checkbox"/> IX-DA, IX-DB <input type="checkbox"/> IX-BA, IX-BB <input type="checkbox"/> IX-DV, IX-DVF(-*) <input type="checkbox"/> IX-SSA(-*) <input type="checkbox"/> IX-EA, IX-EAU <input type="checkbox"/> IX-FA <input type="checkbox"/> IXGW-LC <input type="checkbox"/> IXGW-(T)GW <input type="checkbox"/> Intercom App <input type="checkbox"/> IX-SS-2G <input type="checkbox"/> IX-RS-* <input type="checkbox"/> IX-SOFT <input type="checkbox"/> IXW-MA <input type="checkbox"/> IX-SPMIC <input type="checkbox"/> VoIP Phone <input type="checkbox"/> IX-DVM
Description	Configure whether to display the button to switch "Automatic Open."
Settings	<ul style="list-style-type: none"> • Enable • Disable

■ Reception Mode Button

Compatible type	<input type="checkbox"/> IXG-2C7(-*) <input checked="" type="checkbox"/> IXG-MK <input type="checkbox"/> IX-MV7-* <input type="checkbox"/> IXG-DM7(-*) <input type="checkbox"/> IX-DA, IX-DB <input type="checkbox"/> IX-BA, IX-BB <input type="checkbox"/> IX-DV, IX-DVF(-*) <input type="checkbox"/> IX-SSA(-*) <input type="checkbox"/> IX-EA, IX-EAU <input type="checkbox"/> IX-FA <input type="checkbox"/> IXGW-LC <input type="checkbox"/> IXGW-(T)GW <input type="checkbox"/> Intercom App <input type="checkbox"/> IX-SS-2G <input type="checkbox"/> IX-RS-* <input type="checkbox"/> IX-SOFT <input type="checkbox"/> IXW-MA <input type="checkbox"/> IX-SPMIC <input type="checkbox"/> VoIP Phone <input type="checkbox"/> IX-DVM
Description	Configure whether to display the button to switch the "reception function." Only stations registered with the guard office may be configured.
Settings	<ul style="list-style-type: none"> • Enable • Disable

9.7.3 Receptionist Mode

If "[Master UI Mode \(→page 209\)](#)" was set to "Receptionist," configure details for the receptionist mode screen.

Important

- In receptionist mode, the following operations are limited.
 - Calling can only be done in the method configured in "[Button Function \(→page 218\)](#)".
 - Auto answer will be performed even if "[Auto Answer \(→page 132\)](#)" is "OFF." However, calls will not be received if "[Reject Incoming Call \(→page 220\)](#)" was set to "Enable."
 - For "Option Input" - "Function" in Administrator mode, only "Call" and "Turn LCD On" are enabled.
 - Functions which can be set in "Relay Output" in Administrator mode.

9.7.3.1 Color Scheme

<p>Compatible type</p>	<p><input checked="" type="checkbox"/>IXG-2C7(-*) <input checked="" type="checkbox"/>IXG-MK <input checked="" type="checkbox"/>IX-MV7-* <input type="checkbox"/>IXG-DM7(-*) <input type="checkbox"/>IX-DA, IX-DB <input type="checkbox"/>IX-BA, IX-BB <input type="checkbox"/>IX-DV, IX-DVF(-*) <input type="checkbox"/>IX-SSA(-*) <input type="checkbox"/>IX-EA, IX-EAU <input type="checkbox"/>IX-FA <input type="checkbox"/>IXGW-LC <input type="checkbox"/>IXGW-(T)GW <input type="checkbox"/>Intercom App <input type="checkbox"/>IX-SS-2G <input type="checkbox"/>IX-RS-* <input type="checkbox"/>IX-SOFT <input type="checkbox"/>IXW-MA <input type="checkbox"/>IX-SPMIC <input type="checkbox"/>VoIP Phone <input type="checkbox"/>IX-DVM</p>
<p>Description</p>	<p>Select the Color Scheme of Receptionist Mode.</p>
<p>Settings</p>	<p>Example where "Screen Layout (→page 213)" is set to "Layout 1"</p> <ul style="list-style-type: none"> Light: <div data-bbox="699 517 1230 808" data-label="Image"> </div> Dark: <div data-bbox="699 909 1230 1227" data-label="Image"> </div>

9.7.3.2 Screen Layout

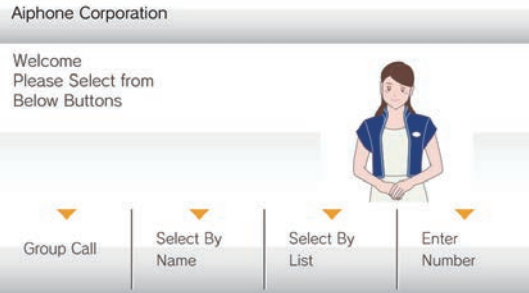
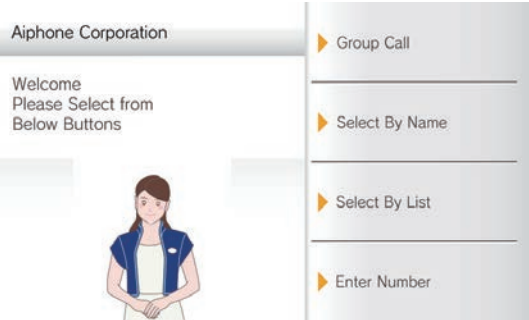
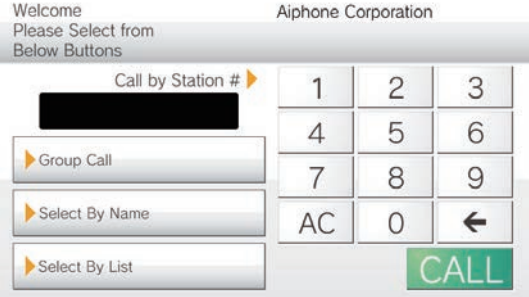
<p>Compatible type</p>	<p><input checked="" type="checkbox"/>IXG-2C7(-*) <input checked="" type="checkbox"/>IXG-MK <input checked="" type="checkbox"/>IX-MV7-* <input type="checkbox"/>IXG-DM7(-*) <input type="checkbox"/>IX-DA, IX-DB <input type="checkbox"/>IX-BA, IX-BB <input type="checkbox"/>IX-DV, IX-DVF(-*) <input type="checkbox"/>IX-SSA(-*) <input type="checkbox"/>IX-EA, IX-EAU <input type="checkbox"/>IX-FA <input type="checkbox"/>IXGW-LC <input type="checkbox"/>IXGW-(T)GW <input type="checkbox"/>Intercom App <input type="checkbox"/>IX-SS-2G <input type="checkbox"/>IX-RS-* <input type="checkbox"/>IX-SOFT <input type="checkbox"/>IXW-MA <input type="checkbox"/>IX-SPMIC <input type="checkbox"/>VoIP Phone <input type="checkbox"/>IX-DVM</p>
<p>Description</p>	<p>Select the Screen Layout of top image for Receptionist Mode.</p>
<p>Settings</p>	<p>Example where "Color Scheme (→page 212)" is set to "Light"</p> <ul style="list-style-type: none"> Layout 1:  <ul style="list-style-type: none"> Layout 2:  <ul style="list-style-type: none"> Layout 3: 

Customizing each screen layout

The layout of each characters screen's, images, and button displays can be customized.

The following spaces are customized by configuring [“Company Information \(→page 215\)”](#) [“Greeting Information \(→page 216\)”](#) [“Images \(→page 217\)”](#) [“Button Function \(→page 218\)”](#).

Layout 1

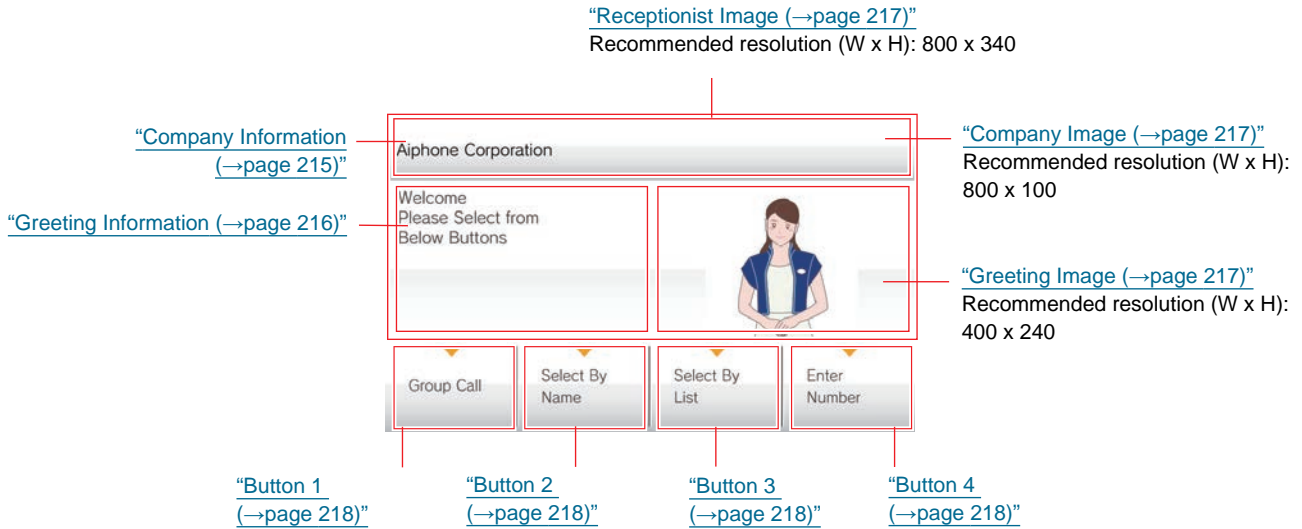

Layout 2

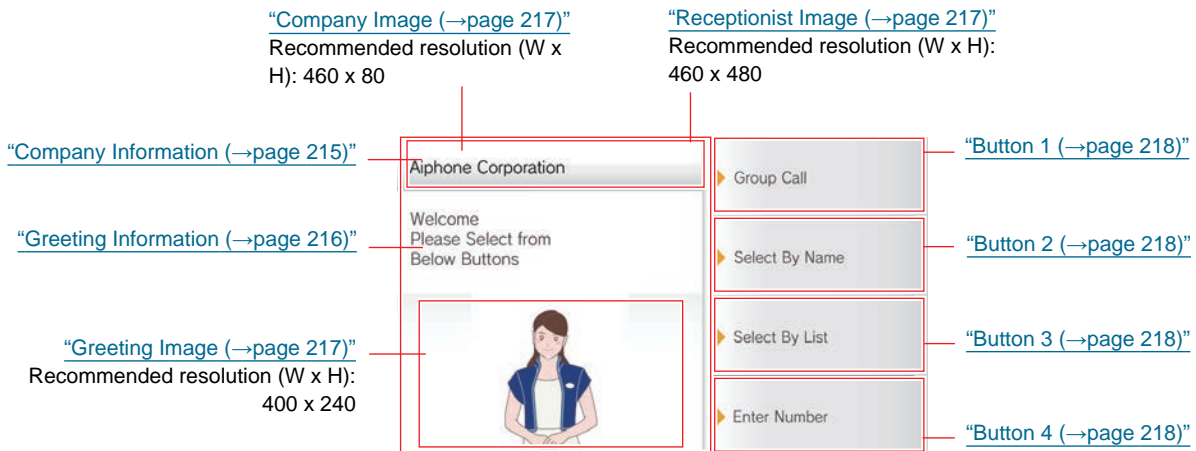

Layout 3

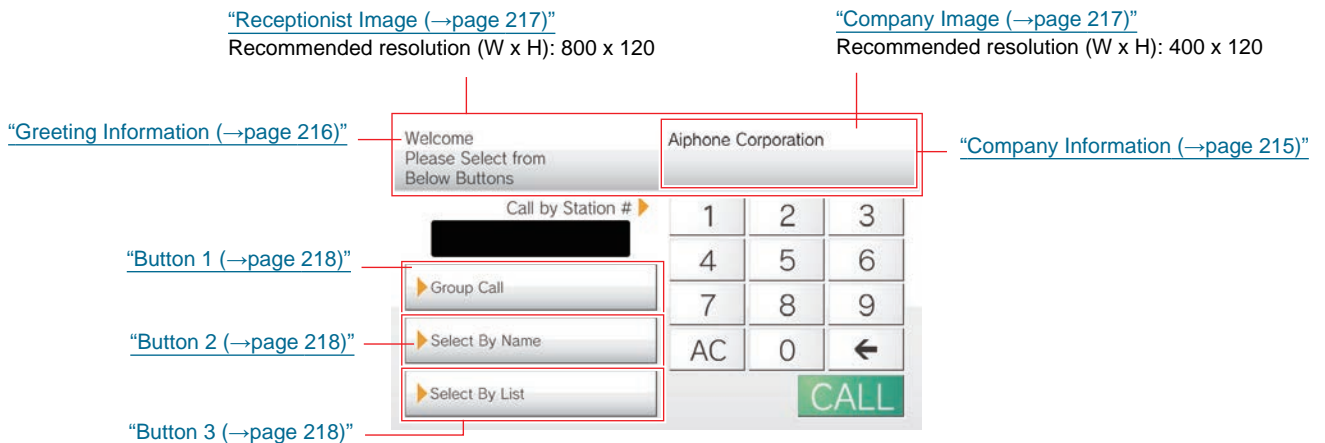

9.7.3.3 Company Information

■ Name

Compatible type	<input type="checkbox"/> IXG-2C7(-*) <input type="checkbox"/> IXG-MK <input checked="" type="checkbox"/> IX-MV7-* <input type="checkbox"/> IXG-DM7(-*) <input type="checkbox"/> IX-DA, IX-DB <input type="checkbox"/> IX-BA, IX-BB <input type="checkbox"/> IX-DV, IX-DVF(-*) <input type="checkbox"/> IX-SSA(-*) <input type="checkbox"/> IX-EA, IX-EAU <input type="checkbox"/> IX-FA <input type="checkbox"/> IXGW-LC <input type="checkbox"/> IXGW-(T)GW <input type="checkbox"/> Intercom App <input type="checkbox"/> IX-SS-2G <input type="checkbox"/> IX-RS-* <input type="checkbox"/> IX-SOFT <input type="checkbox"/> IXW-MA <input type="checkbox"/> IX-SPMIC <input type="checkbox"/> VoIP Phone <input type="checkbox"/> IX-DVM
Description	Enter the Company Information.
Settings	0-40 alphanumeric characters

■ Text Size◆

Compatible type	<input type="checkbox"/> IXG-2C7(-*) <input type="checkbox"/> IXG-MK <input checked="" type="checkbox"/> IX-MV7-* <input type="checkbox"/> IXG-DM7(-*) <input type="checkbox"/> IX-DA, IX-DB <input type="checkbox"/> IX-BA, IX-BB <input type="checkbox"/> IX-DV, IX-DVF(-*) <input type="checkbox"/> IX-SSA(-*) <input type="checkbox"/> IX-EA, IX-EAU <input type="checkbox"/> IX-FA <input type="checkbox"/> IXGW-LC <input type="checkbox"/> IXGW-(T)GW <input type="checkbox"/> Intercom App <input type="checkbox"/> IX-SS-2G <input type="checkbox"/> IX-RS-* <input type="checkbox"/> IX-SOFT <input type="checkbox"/> IXW-MA <input type="checkbox"/> IX-SPMIC <input type="checkbox"/> VoIP Phone <input type="checkbox"/> IX-DVM
Description	Set the text size of Company Information.
Settings	12-24 pt (by 1 pt)

■ Bold

Compatible type	<input type="checkbox"/> IXG-2C7(-*) <input type="checkbox"/> IXG-MK <input checked="" type="checkbox"/> IX-MV7-* <input type="checkbox"/> IXG-DM7(-*) <input type="checkbox"/> IX-DA, IX-DB <input type="checkbox"/> IX-BA, IX-BB <input type="checkbox"/> IX-DV, IX-DVF(-*) <input type="checkbox"/> IX-SSA(-*) <input type="checkbox"/> IX-EA, IX-EAU <input type="checkbox"/> IX-FA <input type="checkbox"/> IXGW-LC <input type="checkbox"/> IXGW-(T)GW <input type="checkbox"/> Intercom App <input type="checkbox"/> IX-SS-2G <input type="checkbox"/> IX-RS-* <input type="checkbox"/> IX-SOFT <input type="checkbox"/> IXW-MA <input type="checkbox"/> IX-SPMIC <input type="checkbox"/> VoIP Phone <input type="checkbox"/> IX-DVM
Description	Select Normal / Bold for Bold text.
Settings	<ul style="list-style-type: none"> • Normal • Bold

■ Text Color

Compatible type	<input type="checkbox"/> IXG-2C7(-*) <input type="checkbox"/> IXG-MK <input checked="" type="checkbox"/> IX-MV7-* <input type="checkbox"/> IXG-DM7(-*) <input type="checkbox"/> IX-DA, IX-DB <input type="checkbox"/> IX-BA, IX-BB <input type="checkbox"/> IX-DV, IX-DVF(-*) <input type="checkbox"/> IX-SSA(-*) <input type="checkbox"/> IX-EA, IX-EAU <input type="checkbox"/> IX-FA <input type="checkbox"/> IXGW-LC <input type="checkbox"/> IXGW-(T)GW <input type="checkbox"/> Intercom App <input type="checkbox"/> IX-SS-2G <input type="checkbox"/> IX-RS-* <input type="checkbox"/> IX-SOFT <input type="checkbox"/> IXW-MA <input type="checkbox"/> IX-SPMIC <input type="checkbox"/> VoIP Phone <input type="checkbox"/> IX-DVM
Description	Set the text color of Company Information.
Settings	<ul style="list-style-type: none"> • Option 1 "Black" if "Color Scheme (→page 212)" was set to "Light." "White" if set to "Dark." • Option 2 "Blue" if "Color Scheme (→page 212)" was set to "Light." "Orange" if set to "Dark."

9.7.3.4 Greeting Information

■ Greeting

Compatible type	<input type="checkbox"/> IXG-2C7(-*) <input type="checkbox"/> IXG-MK <input checked="" type="checkbox"/> IX-MV7-* <input type="checkbox"/> IXG-DM7(-*) <input type="checkbox"/> IX-DA, IX-DB <input type="checkbox"/> IX-BA, IX-BB <input type="checkbox"/> IX-DV, IX-DVF(-*) <input type="checkbox"/> IX-SSA(-*) <input type="checkbox"/> IX-EA, IX-EAU <input type="checkbox"/> IX-FA <input type="checkbox"/> IXGW-LC <input type="checkbox"/> IXGW-(T)GW <input type="checkbox"/> Intercom App <input type="checkbox"/> IX-SS-2G <input type="checkbox"/> IX-RS-* <input type="checkbox"/> IX-SOFT <input type="checkbox"/> IXW-MA <input type="checkbox"/> IX-SPMIC <input type="checkbox"/> VoIP Phone <input type="checkbox"/> IX-DVM
Description	Enter Greeting text. Enter manually, or click "Input" and enter the text.
Settings	0-100 alphanumeric characters (Up to 10 line breaks can be inserted. Insert a line break by pressing "Alt" + "Enter.")

■ Text Size◆

Compatible type	<input type="checkbox"/> IXG-2C7(-*) <input type="checkbox"/> IXG-MK <input checked="" type="checkbox"/> IX-MV7-* <input type="checkbox"/> IXG-DM7(-*) <input type="checkbox"/> IX-DA, IX-DB <input type="checkbox"/> IX-BA, IX-BB <input type="checkbox"/> IX-DV, IX-DVF(-*) <input type="checkbox"/> IX-SSA(-*) <input type="checkbox"/> IX-EA, IX-EAU <input type="checkbox"/> IX-FA <input type="checkbox"/> IXGW-LC <input type="checkbox"/> IXGW-(T)GW <input type="checkbox"/> Intercom App <input type="checkbox"/> IX-SS-2G <input type="checkbox"/> IX-RS-* <input type="checkbox"/> IX-SOFT <input type="checkbox"/> IXW-MA <input type="checkbox"/> IX-SPMIC <input type="checkbox"/> VoIP Phone <input type="checkbox"/> IX-DVM
Description	Set the text size of Greeting.
Settings	12-70 pt (by 1 pt)

■ Bold

Compatible type	<input type="checkbox"/> IXG-2C7(-*) <input type="checkbox"/> IXG-MK <input checked="" type="checkbox"/> IX-MV7-* <input type="checkbox"/> IXG-DM7(-*) <input type="checkbox"/> IX-DA, IX-DB <input type="checkbox"/> IX-BA, IX-BB <input type="checkbox"/> IX-DV, IX-DVF(-*) <input type="checkbox"/> IX-SSA(-*) <input type="checkbox"/> IX-EA, IX-EAU <input type="checkbox"/> IX-FA <input type="checkbox"/> IXGW-LC <input type="checkbox"/> IXGW-(T)GW <input type="checkbox"/> Intercom App <input type="checkbox"/> IX-SS-2G <input type="checkbox"/> IX-RS-* <input type="checkbox"/> IX-SOFT <input type="checkbox"/> IXW-MA <input type="checkbox"/> IX-SPMIC <input type="checkbox"/> VoIP Phone <input type="checkbox"/> IX-DVM
Description	Select Normal / Bold for Bold text.
Settings	<ul style="list-style-type: none"> • Normal • Bold

■ Text Color

Compatible type	<input type="checkbox"/> IXG-2C7(-*) <input type="checkbox"/> IXG-MK <input checked="" type="checkbox"/> IX-MV7-* <input type="checkbox"/> IXG-DM7(-*) <input type="checkbox"/> IX-DA, IX-DB <input type="checkbox"/> IX-BA, IX-BB <input type="checkbox"/> IX-DV, IX-DVF(-*) <input type="checkbox"/> IX-SSA(-*) <input type="checkbox"/> IX-EA, IX-EAU <input type="checkbox"/> IX-FA <input type="checkbox"/> IXGW-LC <input type="checkbox"/> IXGW-(T)GW <input type="checkbox"/> Intercom App <input type="checkbox"/> IX-SS-2G <input type="checkbox"/> IX-RS-* <input type="checkbox"/> IX-SOFT <input type="checkbox"/> IXW-MA <input type="checkbox"/> IX-SPMIC <input type="checkbox"/> VoIP Phone <input type="checkbox"/> IX-DVM
Description	Set the text color of Greeting.
Settings	<ul style="list-style-type: none"> • Option 1 "Black" if "Color Scheme (→page 212)" was set to "Light." "White" if set to "Dark." • Option 2 "Blue" if "Color Scheme (→page 212)" was set to "Light." "Orange" if set to "Dark."

9.7.3.5 Images

Upload the image file to be shown on the reception screen. Upload an image file that suits the layout configured in [“Screen Layout \(→page 213\)”](#). Refer to [“Customizing each screen layout \(→page 214\)”](#) for recommended image file resolutions for each screen layout.

■ Company Image

Compatible type	<input type="checkbox"/> IXG-2C7(-*) <input type="checkbox"/> IXG-MK <input checked="" type="checkbox"/> IX-MV7-* <input type="checkbox"/> IXG-DM7(-*) <input type="checkbox"/> IX-DA, IX-DB <input type="checkbox"/> IX-BA, IX-BB <input type="checkbox"/> IX-DV, IX-DVF(-*) <input type="checkbox"/> IX-SSA(-*) <input type="checkbox"/> IX-EA, IX-EAU <input type="checkbox"/> IX-FA <input type="checkbox"/> IXGW-LC <input type="checkbox"/> IXGW-(T)GW <input type="checkbox"/> Intercom App <input type="checkbox"/> IX-SS-2G <input type="checkbox"/> IX-RS-* <input type="checkbox"/> IX-SOFT <input type="checkbox"/> IXW-MA <input type="checkbox"/> IX-SPMIC <input type="checkbox"/> VoIP Phone <input type="checkbox"/> IX-DVM
Description	Update Company Image. Image file format: <ul style="list-style-type: none"> • File Name: 1-59 alphanumeric characters (excluding extension) • Format: png • Resolution Width: 400 - 800 pixels Height: 80 - 480 pixels
Settings	Register: Click [Browse] to select a file. Delete: Check the [Delete] box.

■ Greeting Image

Compatible type	<input type="checkbox"/> IXG-2C7(-*) <input type="checkbox"/> IXG-MK <input checked="" type="checkbox"/> IX-MV7-* <input type="checkbox"/> IXG-DM7(-*) <input type="checkbox"/> IX-DA, IX-DB <input type="checkbox"/> IX-BA, IX-BB <input type="checkbox"/> IX-DV, IX-DVF(-*) <input type="checkbox"/> IX-SSA(-*) <input type="checkbox"/> IX-EA, IX-EAU <input type="checkbox"/> IX-FA <input type="checkbox"/> IXGW-LC <input type="checkbox"/> IXGW-(T)GW <input type="checkbox"/> Intercom App <input type="checkbox"/> IX-SS-2G <input type="checkbox"/> IX-RS-* <input type="checkbox"/> IX-SOFT <input type="checkbox"/> IXW-MA <input type="checkbox"/> IX-SPMIC <input type="checkbox"/> VoIP Phone <input type="checkbox"/> IX-DVM
Description	Update Greeting Image. Image file format: <ul style="list-style-type: none"> • File Name: 1-59 alphanumeric characters (excluding extension) • Format: png • Resolution Width: 400 - 800 pixels Height: 80 - 480 pixels
Settings	Register: Click [Browse] to select a file. Delete: Check the [Delete] box.

■ Receptionist Image

Compatible type	<input type="checkbox"/> IXG-2C7(-*) <input type="checkbox"/> IXG-MK <input checked="" type="checkbox"/> IX-MV7-* <input type="checkbox"/> IXG-DM7(-*) <input type="checkbox"/> IX-DA, IX-DB <input type="checkbox"/> IX-BA, IX-BB <input type="checkbox"/> IX-DV, IX-DVF(-*) <input type="checkbox"/> IX-SSA(-*) <input type="checkbox"/> IX-EA, IX-EAU <input type="checkbox"/> IX-FA <input type="checkbox"/> IXGW-LC <input type="checkbox"/> IXGW-(T)GW <input type="checkbox"/> Intercom App <input type="checkbox"/> IX-SS-2G <input type="checkbox"/> IX-RS-* <input type="checkbox"/> IX-SOFT <input type="checkbox"/> IXW-MA <input type="checkbox"/> IX-SPMIC <input type="checkbox"/> VoIP Phone <input type="checkbox"/> IX-DVM
Description	Update Receptionist Image. Image file format: <ul style="list-style-type: none"> • File Name: 1-59 alphanumeric characters (excluding extension) • Format: png • Resolution Width: 400 - 800 pixels Height: 80 - 480 pixels
Settings	Register: Click [Browse] to select a file. Delete: Check the [Delete] box.

Note

- Image file names are uploaded through "Images" in [“Upload Settings \(→page 71\)”](#), and are deleted from the Settings screen when the image file is deleted from the station.

9.7.3.6 Button Function

Configure the buttons to be shown on the reception screen and their function. Refer to [“Customizing each screen layout \(→page 214\)”](#) for configuration.

■ Button 1

Compatible type	<input type="checkbox"/> IXG-2C7(-*) <input type="checkbox"/> IXG-MK <input checked="" type="checkbox"/> IX-MV7-* <input type="checkbox"/> IXG-DM7(-*) <input type="checkbox"/> IX-DA, IX-DB <input type="checkbox"/> IX-BA, IX-BB <input type="checkbox"/> IX-DV, IX-DVF(-*) <input type="checkbox"/> IX-SSA(-*) <input type="checkbox"/> IX-EA, IX-EAU <input type="checkbox"/> IX-FA <input type="checkbox"/> IXGW-LC <input type="checkbox"/> IXGW-(T)GW <input type="checkbox"/> Intercom App <input type="checkbox"/> IX-SS-2G <input type="checkbox"/> IX-RS-* <input type="checkbox"/> IX-SOFT <input type="checkbox"/> IXW-MA <input type="checkbox"/> IX-SPMIC <input type="checkbox"/> VoIP Phone <input type="checkbox"/> IX-DVM
Description	Configure the function of Button 1.
Settings	<ul style="list-style-type: none"> • Group Call: Call the group set in “Group Call Destination (→page 219)”. • Select By Name: Select the call destination from the station name and group name. • Select By List: Select the call destination from the group list. • Enter Number: Select the call destination from the station number. • Hide: Do not display the button.

■ Button 2

Compatible type	<input type="checkbox"/> IXG-2C7(-*) <input type="checkbox"/> IXG-MK <input checked="" type="checkbox"/> IX-MV7-* <input type="checkbox"/> IXG-DM7(-*) <input type="checkbox"/> IX-DA, IX-DB <input type="checkbox"/> IX-BA, IX-BB <input type="checkbox"/> IX-DV, IX-DVF(-*) <input type="checkbox"/> IX-SSA(-*) <input type="checkbox"/> IX-EA, IX-EAU <input type="checkbox"/> IX-FA <input type="checkbox"/> IXGW-LC <input type="checkbox"/> IXGW-(T)GW <input type="checkbox"/> Intercom App <input type="checkbox"/> IX-SS-2G <input type="checkbox"/> IX-RS-* <input type="checkbox"/> IX-SOFT <input type="checkbox"/> IXW-MA <input type="checkbox"/> IX-SPMIC <input type="checkbox"/> VoIP Phone <input type="checkbox"/> IX-DVM
Description	Configure the function of Button 2.
Settings	<ul style="list-style-type: none"> • Group Call: Call the group set in “Group Call Destination (→page 219)”. • Select By Name: Select the call destination from the station name and group name. • Select By List: Select the call destination from the group list. • Enter Number: Select the call destination from the station number. • Hide: Do not display the button.

■ Button 3

Compatible type	<input type="checkbox"/> IXG-2C7(-*) <input type="checkbox"/> IXG-MK <input checked="" type="checkbox"/> IX-MV7-* <input type="checkbox"/> IXG-DM7(-*) <input type="checkbox"/> IX-DA, IX-DB <input type="checkbox"/> IX-BA, IX-BB <input type="checkbox"/> IX-DV, IX-DVF(-*) <input type="checkbox"/> IX-SSA(-*) <input type="checkbox"/> IX-EA, IX-EAU <input type="checkbox"/> IX-FA <input type="checkbox"/> IXGW-LC <input type="checkbox"/> IXGW-(T)GW <input type="checkbox"/> Intercom App <input type="checkbox"/> IX-SS-2G <input type="checkbox"/> IX-RS-* <input type="checkbox"/> IX-SOFT <input type="checkbox"/> IXW-MA <input type="checkbox"/> IX-SPMIC <input type="checkbox"/> VoIP Phone <input type="checkbox"/> IX-DVM
Description	Configure the function of Button 3.
Settings	<ul style="list-style-type: none"> • Group Call: Call the group set in “Group Call Destination (→page 219)”. • Select By Name: Select the call destination from the station name and group name. • Select By List: Select the call destination from the group list. • Enter Number: Select the call destination from the station number. • Hide: Do not display the button.

■ Button 4

Compatible type	<input type="checkbox"/> IXG-2C7(-*) <input type="checkbox"/> IXG-MK <input checked="" type="checkbox"/> IX-MV7-* <input type="checkbox"/> IXG-DM7(-*) <input type="checkbox"/> IX-DA, IX-DB <input type="checkbox"/> IX-BA, IX-BB <input type="checkbox"/> IX-DV, IX-DVF(-*) <input type="checkbox"/> IX-SSA(-*) <input type="checkbox"/> IX-EA, IX-EAU <input type="checkbox"/> IX-FA <input type="checkbox"/> IXGW-LC <input type="checkbox"/> IXGW-(T)GW <input type="checkbox"/> Intercom App <input type="checkbox"/> IX-SS-2G <input type="checkbox"/> IX-RS-* <input type="checkbox"/> IX-SOFT <input type="checkbox"/> IXW-MA <input type="checkbox"/> IX-SPMIC <input type="checkbox"/> VoIP Phone <input type="checkbox"/> IX-DVM
Description	Configure the function of Button 4.
Settings	<ul style="list-style-type: none"> • Group Call: Call the group set in “Group Call Destination (→page 219)”. • Select By Name: Select the call destination from the station name and group name. • Select By List: Select the call destination from the group list. • Enter Number: Select the call destination from the station number. • Hide: Do not display the button.

■ Button Name for Group Call

Compatible type	<input type="checkbox"/> IXG-2C7(-*) <input type="checkbox"/> IXG-MK <input checked="" type="checkbox"/> IX-MV7-* <input type="checkbox"/> IXG-DM7(-*) <input type="checkbox"/> IX-DA, IX-DB <input type="checkbox"/> IX-BA, IX-BB <input type="checkbox"/> IX-DV, IX-DVF(-*) <input type="checkbox"/> IX-SSA(-*) <input type="checkbox"/> IX-EA, IX-EAU <input type="checkbox"/> IX-FA <input type="checkbox"/> IXGW-LC <input type="checkbox"/> IXGW-(T)GW <input type="checkbox"/> Intercom App <input type="checkbox"/> IX-SS-2G <input type="checkbox"/> IX-RS-* <input type="checkbox"/> IX-SOFT <input type="checkbox"/> IXW-MA <input type="checkbox"/> IX-SPMIC <input type="checkbox"/> VoIP Phone <input type="checkbox"/> IX-DVM
Description	Configure the names of the buttons, when "Group Call" is selected for "Button 1" through "Button 4." If "Group Call" was set to multiple buttons, they will all share the same name.
Settings	1-24 alphanumeric characters

■ Button Name for Select by Name

Compatible type	<input type="checkbox"/> IXG-2C7(-*) <input type="checkbox"/> IXG-MK <input checked="" type="checkbox"/> IX-MV7-* <input type="checkbox"/> IXG-DM7(-*) <input type="checkbox"/> IX-DA, IX-DB <input type="checkbox"/> IX-BA, IX-BB <input type="checkbox"/> IX-DV, IX-DVF(-*) <input type="checkbox"/> IX-SSA(-*) <input type="checkbox"/> IX-EA, IX-EAU <input type="checkbox"/> IX-FA <input type="checkbox"/> IXGW-LC <input type="checkbox"/> IXGW-(T)GW <input type="checkbox"/> Intercom App <input type="checkbox"/> IX-SS-2G <input type="checkbox"/> IX-RS-* <input type="checkbox"/> IX-SOFT <input type="checkbox"/> IXW-MA <input type="checkbox"/> IX-SPMIC <input type="checkbox"/> VoIP Phone <input type="checkbox"/> IX-DVM
Description	Configure the names of the buttons, when "Select By Name" is selected for "Button 1" through "Button 4." If "Select By Name" was set to multiple buttons, they will all share the same name.
Settings	1-24 alphanumeric characters

■ Button Name for Select by List

Compatible type	<input type="checkbox"/> IXG-2C7(-*) <input type="checkbox"/> IXG-MK <input checked="" type="checkbox"/> IX-MV7-* <input type="checkbox"/> IXG-DM7(-*) <input type="checkbox"/> IX-DA, IX-DB <input type="checkbox"/> IX-BA, IX-BB <input type="checkbox"/> IX-DV, IX-DVF(-*) <input type="checkbox"/> IX-SSA(-*) <input type="checkbox"/> IX-EA, IX-EAU <input type="checkbox"/> IX-FA <input type="checkbox"/> IXGW-LC <input type="checkbox"/> IXGW-(T)GW <input type="checkbox"/> Intercom App <input type="checkbox"/> IX-SS-2G <input type="checkbox"/> IX-RS-* <input type="checkbox"/> IX-SOFT <input type="checkbox"/> IXW-MA <input type="checkbox"/> IX-SPMIC <input type="checkbox"/> VoIP Phone <input type="checkbox"/> IX-DVM
Description	Configure the names of the buttons, when "Select By List" is selected for "Button 1" through "Button 4." If "Select By List" was set to multiple buttons, they will all share the same name.
Settings	1-24 alphanumeric characters

■ Button Name for Enter Number

Compatible type	<input type="checkbox"/> IXG-2C7(-*) <input type="checkbox"/> IXG-MK <input checked="" type="checkbox"/> IX-MV7-* <input type="checkbox"/> IXG-DM7(-*) <input type="checkbox"/> IX-DA, IX-DB <input type="checkbox"/> IX-BA, IX-BB <input type="checkbox"/> IX-DV, IX-DVF(-*) <input type="checkbox"/> IX-SSA(-*) <input type="checkbox"/> IX-EA, IX-EAU <input type="checkbox"/> IX-FA <input type="checkbox"/> IXGW-LC <input type="checkbox"/> IXGW-(T)GW <input type="checkbox"/> Intercom App <input type="checkbox"/> IX-SS-2G <input type="checkbox"/> IX-RS-* <input type="checkbox"/> IX-SOFT <input type="checkbox"/> IXW-MA <input type="checkbox"/> IX-SPMIC <input type="checkbox"/> VoIP Phone <input type="checkbox"/> IX-DVM
Description	Configure the names of the buttons, when "#" is selected for "Button 1" through "Button 4." If "#" was set to multiple buttons, they will all share the same name.
Settings	1-24 alphanumeric characters

9.7.3.7 Group Call Destination

Compatible type	<input type="checkbox"/> IXG-2C7(-*) <input type="checkbox"/> IXG-MK <input checked="" type="checkbox"/> IX-MV7-* <input type="checkbox"/> IXG-DM7(-*) <input type="checkbox"/> IX-DA, IX-DB <input type="checkbox"/> IX-BA, IX-BB <input type="checkbox"/> IX-DV, IX-DVF(-*) <input type="checkbox"/> IX-SSA(-*) <input type="checkbox"/> IX-EA, IX-EAU <input type="checkbox"/> IX-FA <input type="checkbox"/> IXGW-LC <input type="checkbox"/> IXGW-(T)GW <input type="checkbox"/> Intercom App <input type="checkbox"/> IX-SS-2G <input type="checkbox"/> IX-RS-* <input type="checkbox"/> IX-SOFT <input type="checkbox"/> IXW-MA <input type="checkbox"/> IX-SPMIC <input type="checkbox"/> VoIP Phone <input type="checkbox"/> IX-DVM
Description	Set the call destination group numbers for when the buttons are pressed, if "Group Call" was selected for "Button 1" through "Button 4." If "Group Call" was set to multiple buttons, they will all share the same call destination group. Enter the group number manually, or click [Open] to select a group.
Settings	01 - 99

9.7.3.8 Reject Incoming Call

Compatible type	<input type="checkbox"/> IXG-2C7(-*) <input type="checkbox"/> IXG-MK <input checked="" type="checkbox"/> IX-MV7-* <input type="checkbox"/> IXG-DM7(-*) <input type="checkbox"/> IX-DA, IX-DB <input type="checkbox"/> IX-BA, IX-BB <input type="checkbox"/> IX-DV, IX-DVF(-*) <input type="checkbox"/> IX-SSA(-*) <input type="checkbox"/> IX-EA, IX-EAU <input type="checkbox"/> IX-FA <input type="checkbox"/> IXGW-LC <input type="checkbox"/> IXGW-(T)GW <input type="checkbox"/> Intercom App <input type="checkbox"/> IX-SS-2G <input type="checkbox"/> IX-RS-* <input type="checkbox"/> IX-SOFT <input type="checkbox"/> IXW-MA <input type="checkbox"/> IX-SPMIC <input type="checkbox"/> VoIP Phone <input type="checkbox"/> IX-DVM
Description	Select Enable / Disable for incoming calls in Receptionist Mode.
Settings	<ul style="list-style-type: none"> • Enable: Do not receive incoming calls. • Disable: Receive incoming calls.

10. Transfer Settings (Advanced Settings)

10.1 Absent Transfer

Configure the settings for absent transfer.

Absent Transfer: An incoming call can be automatically transferred to another transfer destination when absent transfer is set.

Move row

Up to 50 station number rows can be displayed at a time. Switch the screen as follows.

[Previous]: Display the previous 50 rows.

[Next]: Display the next 50 rows.

[Apply]: Enter the station number and click **[Apply]** to move the cursor to the row of the station number that was entered.

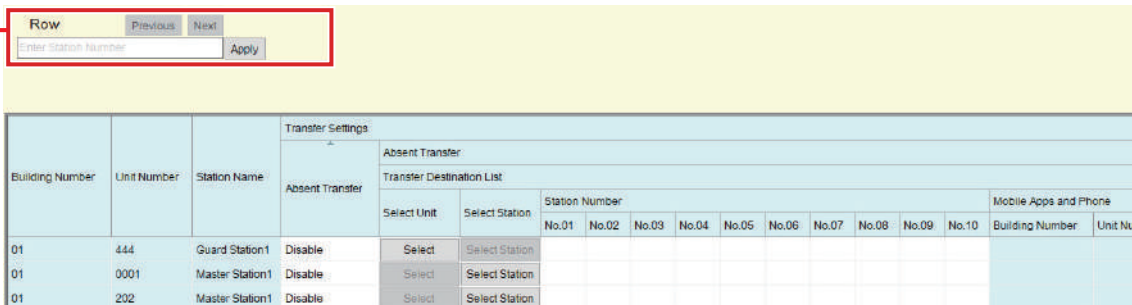

! Important

- When an incoming call is received from a VoIP phone, the call will be received without transferring even if transfer is set. To transfer the call, configure transferring on the IP-PBX.
- A station cannot be set as a transfer destination unless "IP Address" has been configured for the station in Administrator mode.
- For IXG-MK, a Entrance Station or Door Station cannot be set as the transfer destination.
If the transfer source is IX-MV7-* or IX-SOFT, Door Stations outside of the same unit cannot be set as the transfer destination.

■ Absent Transfer

Compatible type	<input type="checkbox"/> IXG-2C7(-*) <input checked="" type="checkbox"/> IXG-MK <input checked="" type="checkbox"/> IX-MV7-* <input type="checkbox"/> IXG-DM7(-*) <input type="checkbox"/> IX-DA, IX-DB <input type="checkbox"/> IX-BA, IX-BB <input type="checkbox"/> IX-DV, IX-DVF(-*) <input type="checkbox"/> IX-SSA(-*) <input type="checkbox"/> IX-EA, IX-EAU <input type="checkbox"/> IX-FA <input type="checkbox"/> IXGW-LC <input type="checkbox"/> IXGW-(T)GW <input type="checkbox"/> Intercom App <input type="checkbox"/> IX-SS-2G <input type="checkbox"/> IX-RS-* <input checked="" type="checkbox"/> IX-SOFT <input type="checkbox"/> IXW-MA <input type="checkbox"/> IX-SPMIC <input type="checkbox"/> VoIP Phone <input type="checkbox"/> IX-DVM
Description	Configure whether to set absent transfer. The setting can also be changed using the button on the station main unit. If "Transfer Destination List" is not configured, this cannot be set to "Enable."
Settings	<ul style="list-style-type: none"> • Enable: Set absent transfer. • Disable: Do not set absent transfer.

Transfer Destination List

Compatible type	<input type="checkbox"/> IXG-2C7(-*) <input checked="" type="checkbox"/> IXG-MK <input checked="" type="checkbox"/> IX-MV7-* <input type="checkbox"/> IXG-DM7(-*) <input type="checkbox"/> IX-DA, IX-DB <input type="checkbox"/> IX-BA, IX-BB <input type="checkbox"/> IX-DV, IX-DVF(-*) <input type="checkbox"/> IX-SSA(-*) <input type="checkbox"/> IX-EA, IX-EAU <input type="checkbox"/> IX-FA <input type="checkbox"/> IXGW-LC <input type="checkbox"/> IXGW-(T)GW <input type="checkbox"/> Intercom App <input type="checkbox"/> IX-SS-2G <input type="checkbox"/> IX-RS-* <input checked="" type="checkbox"/> IX-SOFT <input type="checkbox"/> IXW-MA <input type="checkbox"/> IX-SPMIC <input type="checkbox"/> VoIP Phone <input type="checkbox"/> IX-DVM
Description	<p>To configure IX-MV7-* or IX-SOFT: Configure the transfer destination station (station number) or Mobile Apps and Phones for performing absent transfer. Up to 10 transfer destination stations (Mobile Apps and Phones: 9 stations and a single unit containing the Intercom App or phone) can be configured. However, if the call originating station is IX-DA, IX-DB, IX-BA, IX-BB, calls will only be transferred to the station entered for "No.01."</p> <p>To configure a station, enter the station number manually, or click [Select Station] to select one. To configure Mobile Apps and Phones, click "Mobile Apps and Phone" - [Select] to select one.</p> <p>To configure IXG-MK: Configure the transfer destination unit or transfer destination station (station number) for performing absent transfer. A single unit can be configured as a transfer destination. However, if the call originating station is IX-DA, IX-DB, IX-BA, IX-BB, calls will be transferred only to the station with the lowest station number among the stations belonging to the selected unit. To configure a unit, click [Select] to select one.</p> <p>When configuring by entering the station number, up to 10 transfer destination stations (Mobile Apps and Phones: 9 stations and a single unit containing the Intercom App or phone) can be configured. However, if the call originating station is IX-DA, IX-DB, IX-BA, IX-BB, calls will only be transferred to the station entered for "No.01."</p> <p>To configure Mobile Apps and Phones, click "Mobile Apps and Phone" - [Select] to select one.</p>
Settings	-

Important

- Do not configure multiple VoIP phones. If multiple are configured, calls will be transferred to only one.

Re-Transfer Destination

Compatible type	<input type="checkbox"/> IXG-2C7(-*) <input checked="" type="checkbox"/> IXG-MK <input checked="" type="checkbox"/> IX-MV7-* <input type="checkbox"/> IXG-DM7(-*) <input type="checkbox"/> IX-DA, IX-DB <input type="checkbox"/> IX-BA, IX-BB <input type="checkbox"/> IX-DV, IX-DVF(-*) <input type="checkbox"/> IX-SSA(-*) <input type="checkbox"/> IX-EA, IX-EAU <input type="checkbox"/> IX-FA <input type="checkbox"/> IXGW-LC <input type="checkbox"/> IXGW-(T)GW <input type="checkbox"/> Intercom App <input type="checkbox"/> IX-SS-2G <input type="checkbox"/> IX-RS-* <input checked="" type="checkbox"/> IX-SOFT <input type="checkbox"/> IXW-MA <input type="checkbox"/> IX-SPMIC <input type="checkbox"/> VoIP Phone <input type="checkbox"/> IX-DVM
Description	<p>Configure the transfer destination station (station number) or Mobile Apps and Phones for performing absent transfer again for a transferred call. A single transfer destination station, or single unit containing the Intercom App or phone, can be configured. However, if the call originating station is IX-DA, IX-DB, IX-BA, IX-BB, the call will be received without being retransferred.</p> <p>To configure a station, enter the station number manually, or click [Select Station] to select one. To configure Mobile Apps and Phones, click "Mobile Apps and Phone" - [Select] to select one.</p>
Settings	-

10.2 Delay Transfer

Configure the settings for delay transfer.

Delay Transfer: If an incoming call is received during delay transfer, the call can be automatically transferred to the transfer destination after a certain period of time (the set delay time) elapses with no response.

Move row

Up to 50 station number rows can be displayed at a time. Switch the screen as follows.

[Previous]: Display the previous 50 rows.

[Next]: Display the next 50 rows.

[Apply]: Enter the station number and click **[Apply]** to move the cursor to the row of the station number that was entered.

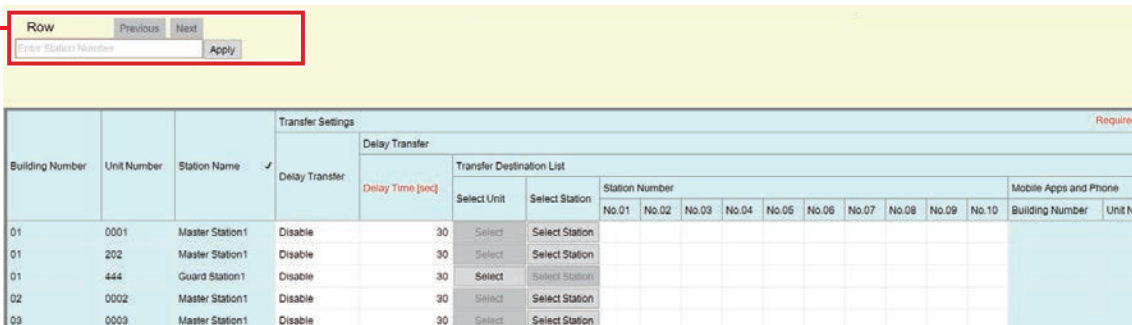

! Important

- When an incoming call is received from a VoIP phone, the call will be received without transferring even if transfer is set. To transfer the call, configure transferring on the IP-PBX.
- A station cannot be set as a transfer destination unless "IP Address" has been configured for the station in Administrator mode.
- For IXG-MK, a Entrance Station or Door Station cannot be set as the transfer destination.
If the transfer source is IX-MV7-* or IX-SOFT, Door Stations outside of the same unit cannot be set as the transfer destination.

■ Delay Transfer

Compatible type	<input type="checkbox"/> IXG-2C7(-*) <input checked="" type="checkbox"/> IXG-MK <input checked="" type="checkbox"/> IX-MV7-* <input type="checkbox"/> IXG-DM7(-*) <input type="checkbox"/> IX-DA, IX-DB <input type="checkbox"/> IX-BA, IX-BB <input type="checkbox"/> IX-DV, IX-DVF(-*) <input type="checkbox"/> IX-SSA(-*) <input type="checkbox"/> IX-EA, IX-EAU <input type="checkbox"/> IX-FA <input type="checkbox"/> IXGW-LC <input type="checkbox"/> IXGW-(T)GW <input type="checkbox"/> Intercom App <input type="checkbox"/> IX-SS-2G <input type="checkbox"/> IX-RS-* <input checked="" type="checkbox"/> IX-SOFT <input type="checkbox"/> IXW-MA <input type="checkbox"/> IX-SPMIC <input type="checkbox"/> VoIP Phone <input type="checkbox"/> IX-DVM
Description	Select Enable / Disable for Delay Transfer. If "Transfer Destination List" is not configured, this cannot be set to "Enable."
Settings	<ul style="list-style-type: none"> • Enable: Delay transfer enabled. • Disable: Delay transfer disabled.

■ Delay Time [sec]◆

Compatible type	<input type="checkbox"/> IXG-2C7(-*) <input checked="" type="checkbox"/> IXG-MK <input checked="" type="checkbox"/> IX-MV7-* <input type="checkbox"/> IXG-DM7(-*) <input type="checkbox"/> IX-DA, IX-DB <input type="checkbox"/> IX-BA, IX-BB <input type="checkbox"/> IX-DV, IX-DVF(-*) <input type="checkbox"/> IX-SSA(-*) <input type="checkbox"/> IX-EA, IX-EAU <input type="checkbox"/> IX-FA <input type="checkbox"/> IXGW-LC <input type="checkbox"/> IXGW-(T)GW <input type="checkbox"/> Intercom App <input type="checkbox"/> IX-SS-2G <input type="checkbox"/> IX-RS-* <input checked="" type="checkbox"/> IX-SOFT <input type="checkbox"/> IXW-MA <input type="checkbox"/> IX-SPMIC <input type="checkbox"/> VoIP Phone <input type="checkbox"/> IX-DVM
Description	Set the delay time between receiving and transferring a call.
Settings	1-300 seconds (by 1 sec.)

Transfer Destination List

Compatible type	<input type="checkbox"/> IXG-2C7(-*) <input checked="" type="checkbox"/> IXG-MK <input checked="" type="checkbox"/> IX-MV7-* <input type="checkbox"/> IXG-DM7(-*) <input type="checkbox"/> IX-DA, IX-DB <input type="checkbox"/> IX-BA, IX-BB <input type="checkbox"/> IX-DV, IX-DVF(-*) <input type="checkbox"/> IX-SSA(-*) <input type="checkbox"/> IX-EA, IX-EAU <input type="checkbox"/> IX-FA <input type="checkbox"/> IXGW-LC <input type="checkbox"/> IXGW-(T)GW <input type="checkbox"/> Intercom App <input type="checkbox"/> IX-SS-2G <input type="checkbox"/> IX-RS-* <input checked="" type="checkbox"/> IX-SOFT <input type="checkbox"/> IXW-MA <input type="checkbox"/> IX-SPMIC <input type="checkbox"/> VoIP Phone <input type="checkbox"/> IX-DVM
Description	<p>To configure IX-MV7-* or IX-SOFT: Configure the transfer destination station (station number) or Mobile Apps and Phones for performing delay transfer. Up to 10 transfer destination stations (Mobile Apps and Phones: 9 stations and a single unit containing the Intercom App or phone) can be configured. However, if the call originating station is IX-DA, IX-DB, IX-BA, IX-BB, calls will only be transferred to the station entered for "No.01."</p> <p>To configure a station, enter the station number manually, or click [Select Station] to select one. To configure Mobile Apps and Phones, click "Mobile Apps and Phone" - [Select] to select one.</p> <p>To configure IXG-MK: Configure the transfer destination unit or transfer destination station (station number) for performing delay transfer. A single unit can be configured as a transfer destination. However, if the call originating station is IX-DA, IX-DB, IX-BA, IX-BB, calls will be transferred only to the station with the lowest station number among the stations belonging to the selected unit. To configure a unit, click [Select] to select one.</p> <p>When configuring by entering the station number, up to 10 transfer destination stations (Mobile Apps and Phones: 9 stations and a single unit containing the Intercom App or phone) can be configured. However, if the call originating station is IX-DA, IX-DB, IX-BA, IX-BB, calls will only be transferred to the station entered for "No.01."</p> <p>To configure Mobile Apps and Phones, click "Mobile Apps and Phone" - [Select] to select one.</p>
Settings	-

Important

- Do not configure multiple VoIP phones. If multiple are configured, calls will be transferred to only one.

Re-Transfer Destination

Compatible type	<input type="checkbox"/> IXG-2C7(-*) <input checked="" type="checkbox"/> IXG-MK <input checked="" type="checkbox"/> IX-MV7-* <input type="checkbox"/> IXG-DM7(-*) <input type="checkbox"/> IX-DA, IX-DB <input type="checkbox"/> IX-BA, IX-BB <input type="checkbox"/> IX-DV, IX-DVF(-*) <input type="checkbox"/> IX-SSA(-*) <input type="checkbox"/> IX-EA, IX-EAU <input type="checkbox"/> IX-FA <input type="checkbox"/> IXGW-LC <input type="checkbox"/> IXGW-(T)GW <input type="checkbox"/> Intercom App <input type="checkbox"/> IX-SS-2G <input type="checkbox"/> IX-RS-* <input checked="" type="checkbox"/> IX-SOFT <input type="checkbox"/> IXW-MA <input type="checkbox"/> IX-SPMIC <input type="checkbox"/> VoIP Phone <input type="checkbox"/> IX-DVM
Description	<p>Configure the transfer destination station (station number) or Mobile Apps and Phones for performing delay transfer again for a transferred call. A single transfer destination station, or single unit containing the Intercom App or phone, can be configured. However, if the call originating station is IX-DA, IX-DB, IX-BA, IX-BB, the call will be received without being retransferred.</p> <p>To configure a station, enter the station number manually, or click [Select Station] to select one. To configure Mobile Apps and Phones, click "Mobile Apps and Phone" - [Select] to select one.</p>
Settings	-

10.3 Schedule Transfer

Configure the settings for Schedule Transfer.

Schedule Transfer: A call can be automatically transferred to a transfer destination when an incoming call is received during the time period set in ["Weekly Schedule \(→page 226\)"](#) and ["Daily Schedule \(→page 228\)"](#).

Move row

Up to 50 station number rows can be displayed at a time. Switch the screen as follows.

[Previous]: Display the previous 50 rows.

[Next]: Display the next 50 rows.

[Apply]: Enter the station number and click **[Apply]** to move the cursor to the row of the station number that was entered.

Weekly schedule

Select the day of week and schedule range to configure to display on the Settings screen.

["Weekly Schedule \(→page 226\)"](#)

["Daily Schedule \(→page 228\)"](#)

Move to Related Settings

Moves to the selected item within the same Settings screen.

! Important

- When an incoming call is received from a VoIP phone, the call will be received without transferring even if transfer is set. To transfer the call, configure transferring on the IP-PBX.
- A station cannot be set as a transfer destination unless "IP Address" has been configured for the station in Administrator mode.
- Incoming calls will be transferred during the time period set in "Schedule Transfer," regardless of the settings in ["Absent Transfer \(→page 221\)"](#) and ["Delay Transfer \(→page 223\)"](#).
- For IXG-MK, a Entrance Station or Door Station cannot be set as the transfer destination.
If the transfer source is IX-MV7-* or IX-SOFT, Door Stations outside of the same unit cannot be set as the transfer destination.

■ Schedule Transfer

Compatible type	<input type="checkbox"/> IXG-2C7(-*) <input checked="" type="checkbox"/> IXG-MK <input checked="" type="checkbox"/> IX-MV7-* <input type="checkbox"/> IXG-DM7(-*) <input type="checkbox"/> IX-DA, IX-DB <input type="checkbox"/> IX-BA, IX-BB <input type="checkbox"/> IX-DV, IX-DVF(-*) <input type="checkbox"/> IX-SSA(-*) <input type="checkbox"/> IX-EA, IX-EAU <input type="checkbox"/> IX-FA <input type="checkbox"/> IXGW-LC <input type="checkbox"/> IXGW-(T)GW <input type="checkbox"/> Intercom App <input type="checkbox"/> IX-SS-2G <input type="checkbox"/> IX-RS-* <input checked="" type="checkbox"/> IX-SOFT <input type="checkbox"/> IXW-MA <input type="checkbox"/> IX-SPMIC <input type="checkbox"/> VoIP Phone <input type="checkbox"/> IX-DVM
Description	Select Enable / Disable for Schedule Transfer. If "Weekly Schedule (→page 226)" or "Daily Schedule (→page 228)" is not configured, this cannot be set to "Enable."
Settings	Enable: Schedule transfer enabled. Disable: Schedule transfer disabled.

10.3.1 Weekly Schedule

Configure the transfer destination and transfer time for every day from Sunday through Saturday. 12 schedules can be set for each day.

Transfer Destination List

Compatible type	<input type="checkbox"/> IXG-2C7(-*) <input checked="" type="checkbox"/> IXG-MK <input checked="" type="checkbox"/> IX-MV7-* <input type="checkbox"/> IXG-DM7(-*) <input type="checkbox"/> IX-DA, IX-DB <input type="checkbox"/> IX-BA, IX-BB <input type="checkbox"/> IX-DV, IX-DVF(-*) <input type="checkbox"/> IX-SSA(-*) <input type="checkbox"/> IX-EA, IX-EAU <input type="checkbox"/> IX-FA <input type="checkbox"/> IXGW-LC <input type="checkbox"/> IXGW-(T)GW <input type="checkbox"/> Intercom App <input type="checkbox"/> IX-SS-2G <input type="checkbox"/> IX-RS-* <input checked="" type="checkbox"/> IX-SOFT <input type="checkbox"/> IXW-MA <input type="checkbox"/> IX-SPMIC <input type="checkbox"/> VoIP Phone <input type="checkbox"/> IX-DVM
Description	<p>To configure IX-MV7-* or IX-SOFT: Configure the transfer destination station (station number) or Mobile Apps and Phones for performing schedule transfer. Up to 10 transfer destination stations (Mobile Apps and Phones: 9 stations and a single unit containing the Intercom App or phone) can be configured for each of the 12 day of the week schedules. However, if the call originating station is IX-DA, IX-DB, IX-BA, IX-BB, calls will only be transferred to the station entered for "No.01."</p> <p>To configure a station, enter the station number manually, or click [Select Station] to select one. To configure Mobile Apps and Phones, click "Mobile Apps and Phone" - [Select] to select one.</p> <p>To configure IXG-MK: Configure the transfer destination unit or transfer destination station (station number) for performing schedule transfer. Only a single unit can be configured as a transfer destination for each of the 12 day of the week schedules. However, if the call originating station is IX-DA, IX-DB, IX-BA, IX-BB, calls will be transferred only to the station with the lowest station number among the stations belonging to the selected unit. To configure a unit, click [Select] to select one.</p> <p>When configuring by entering the station number, up to 10 transfer destination stations (Mobile Apps and Phones: 9 stations and a single unit containing the Intercom App or phone) can be configured. However, if the call originating station is IX-DA, IX-DB, IX-BA, IX-BB, calls will only be transferred to the station entered for "No.01."</p> <p>To configure Mobile Apps and Phones, click "Mobile Apps and Phone" - [Select] to select one.</p>
Settings	-

Important

- Do not configure multiple VoIP phones. If multiple are configured, calls will be transferred to only one.

Re-Transfer Destination

Compatible type	<input type="checkbox"/> IXG-2C7(-*) <input checked="" type="checkbox"/> IXG-MK <input checked="" type="checkbox"/> IX-MV7-* <input type="checkbox"/> IXG-DM7(-*) <input type="checkbox"/> IX-DA, IX-DB <input type="checkbox"/> IX-BA, IX-BB <input type="checkbox"/> IX-DV, IX-DVF(-*) <input type="checkbox"/> IX-SSA(-*) <input type="checkbox"/> IX-EA, IX-EAU <input type="checkbox"/> IX-FA <input type="checkbox"/> IXGW-LC <input type="checkbox"/> IXGW-(T)GW <input type="checkbox"/> Intercom App <input type="checkbox"/> IX-SS-2G <input type="checkbox"/> IX-RS-* <input checked="" type="checkbox"/> IX-SOFT <input type="checkbox"/> IXW-MA <input type="checkbox"/> IX-SPMIC <input type="checkbox"/> VoIP Phone <input type="checkbox"/> IX-DVM
Description	<p>Configure the transfer destination station (station number) or Mobile Apps and Phones when performing schedule transfer again for a transferred call. A single transfer destination station, or single unit containing the Intercom App or phone, can be configured for each of the 12 day of the week schedules. However, if the call originating station is IX-DA, IX-DB, IX-BA, IX-BB, the call will be received without being retransferred.</p> <p>To configure a station, enter the station number manually, or click [Select Station] to select one. To configure Mobile Apps and Phones, click "Mobile Apps and Phone" - [Select] to select one.</p>
Settings	-

Start Time

Compatible type	<input type="checkbox"/> IXG-2C7(-*) <input checked="" type="checkbox"/> IXG-MK <input checked="" type="checkbox"/> IX-MV7-* <input type="checkbox"/> IXG-DM7(-*) <input type="checkbox"/> IX-DA, IX-DB <input type="checkbox"/> IX-BA, IX-BB <input type="checkbox"/> IX-DV, IX-DVF(-*) <input type="checkbox"/> IX-SSA(-*) <input type="checkbox"/> IX-EA, IX-EAU <input type="checkbox"/> IX-FA <input type="checkbox"/> IXGW-LC <input type="checkbox"/> IXGW-(T)GW <input type="checkbox"/> Intercom App <input type="checkbox"/> IX-SS-2G <input type="checkbox"/> IX-RS-* <input checked="" type="checkbox"/> IX-SOFT <input type="checkbox"/> IXW-MA <input type="checkbox"/> IX-SPMIC <input type="checkbox"/> VoIP Phone <input type="checkbox"/> IX-DVM
Description	Set the Start Time to enable schedule transfer.
Settings	00:00 - 23:59

End Time

Compatible type	<input type="checkbox"/> IXG-2C7(-*) <input checked="" type="checkbox"/> IXG-MK <input checked="" type="checkbox"/> IX-MV7-* <input type="checkbox"/> IXG-DM7(-*) <input type="checkbox"/> IX-DA, IX-DB <input type="checkbox"/> IX-BA, IX-BB <input type="checkbox"/> IX-DV, IX-DVF(-*) <input type="checkbox"/> IX-SSA(-*) <input type="checkbox"/> IX-EA, IX-EAU <input type="checkbox"/> IX-FA <input type="checkbox"/> IXGW-LC <input type="checkbox"/> IXGW-(T)GW <input type="checkbox"/> Intercom App <input type="checkbox"/> IX-SS-2G <input type="checkbox"/> IX-RS-* <input checked="" type="checkbox"/> IX-SOFT <input type="checkbox"/> IXW-MA <input type="checkbox"/> IX-SPMIC <input type="checkbox"/> VoIP Phone <input type="checkbox"/> IX-DVM
Description	Configure the time at which to end schedule transfer. If set earlier than "Start Time," the end time will be that time on the following day.
Settings	00:00 - 23:59

How to configure schedule view

Configure the day and schedule range shown on the Settings screen for the weekly schedule.

The display can be filtered to show only the day and schedule to configure.

Click **[Schedule View Adjustment]**. The following screen will be shown.

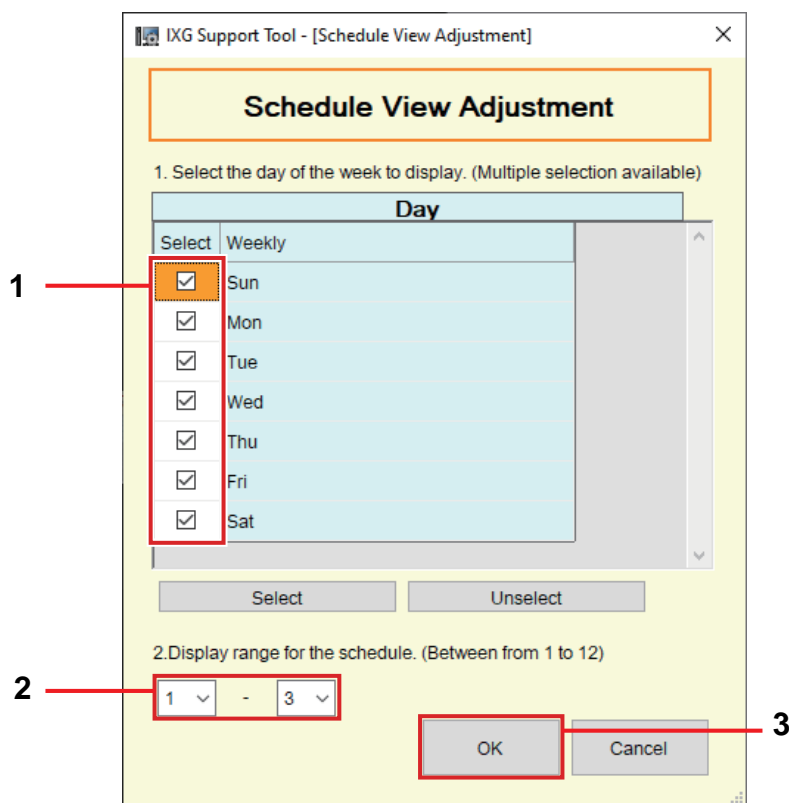

1. Select the day to display from "Day." (Multiple selections allowed.)
 - To select or unselect all days at once, click **[Select]** or **[Unselect]**.
 - By default, all days are shown.
2. Select the range of schedules to display (1 - 12) that can be configured for each day.
 - By default, the range of 1 - 3 is displayed.

3. Click **[OK]**.
 - Click **[Cancel]** to finish configuring the schedule display.

10.3.2 Daily Schedule

Configure the transfer destination and time for each individual day. A schedule to the end of the month one year from the set day can be configured. 12 schedules can be set for each day.

Move row

Up to 50 station number rows can be displayed at a time. Switch the screen as follows.
[Previous]: Display the previous 50 rows.
[Next]: Display the next 50 rows.
[Apply]: Enter the station number and click **[Apply]** to move the cursor to the row of the station number that was entered.

Daily schedule

Select the date and schedule range to configure. The Settings screen is displayed.

1. Select the date from the drop down menu.
2. Select the range of schedules to display (1 - 12) that can be configured for each day.
 - By default, the range of 1 - 3 is displayed.
3. Click **[Change to Daily Schedule Display]**.

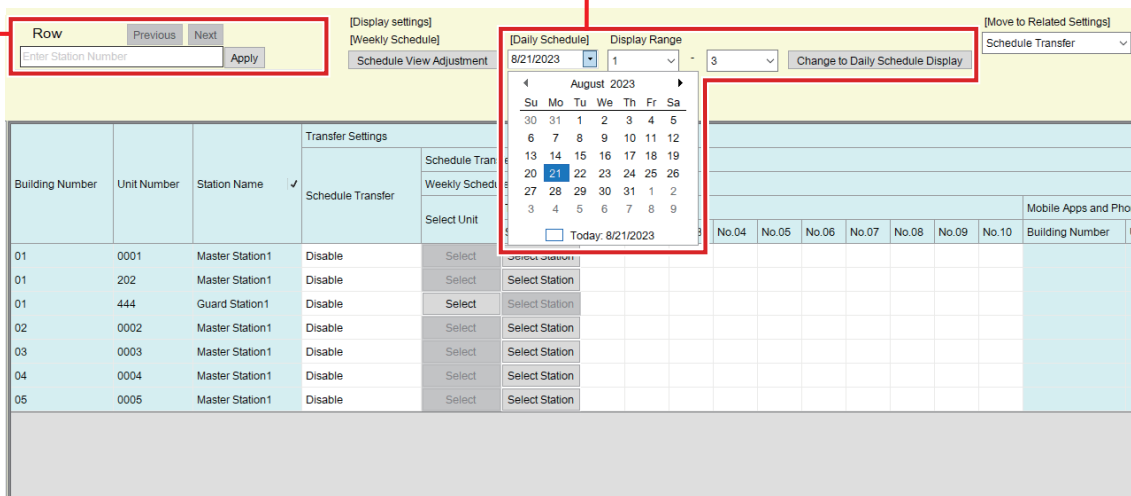

Transfer Destination List

Compatible type	<input type="checkbox"/> IXG-2C7(-*) <input checked="" type="checkbox"/> IXG-MK <input checked="" type="checkbox"/> IX-MV7-* <input type="checkbox"/> IXG-DM7(-*) <input type="checkbox"/> IX-DA, IX-DB <input type="checkbox"/> IX-BA, IX-BB <input type="checkbox"/> IX-DV, IX-DVF(-*) <input type="checkbox"/> IX-SSA(-*) <input type="checkbox"/> IX-EA, IX-EAU <input type="checkbox"/> IX-FA <input type="checkbox"/> IXGW-LC <input type="checkbox"/> IXGW-(T)GW <input type="checkbox"/> Intercom App <input type="checkbox"/> IX-SS-2G <input type="checkbox"/> IX-RS-* <input checked="" type="checkbox"/> IX-SOFT <input type="checkbox"/> IXW-MA <input type="checkbox"/> IX-SPMIC <input type="checkbox"/> VoIP Phone <input type="checkbox"/> IX-DVM
Description	<p>To configure IX-MV7-* or IX-SOFT: Configure the transfer destination station (station number) or Mobile Apps and Phones for performing schedule transfer. Up to 10 transfer destination stations (Mobile Apps and Phones: 9 stations and a single unit containing the Intercom App or phone) can be configured for each of the 12 day schedules. However, if the call originating station is IX-DA, IX-DB, IX-BA, IX-BB, calls will only be transferred to the station entered for "No.01."</p> <p>To configure a station, enter the station number manually, or click [Select Station] to select one. To configure Mobile Apps and Phones, click "Mobile Apps and Phone" - [Select] to select one.</p> <p>To configure IXG-MK: Configure the transfer destination unit or transfer destination station (station number) for performing schedule transfer. Only a single unit can be configured as a transfer destination for each of the 12 day schedules. However, if the call originating station is IX-DA, IX-DB, IX-BA, IX-BB, calls will be transferred only to the station with the lowest station number among the stations belonging to the selected unit.</p> <p>To configure a unit, click [Select] to select one. When configuring by entering the station number, up to 10 transfer destination stations (Mobile Apps and Phones: 9 stations and a single unit containing the Intercom App or phone) can be configured. However, if the call originating station is IX-DA, IX-DB, IX-BA, IX-BB, calls will only be transferred to the station entered for "No.01."</p> <p>To configure Mobile Apps and Phones, click "Mobile Apps and Phone" - [Select] to select one.</p>
Settings	-

Important

- Do not configure multiple VoIP phones. If multiple are configured, calls will be transferred to only one.

Re-Transfer Destination

Compatible type	<input type="checkbox"/> IXG-2C7(-*) <input checked="" type="checkbox"/> IXG-MK <input checked="" type="checkbox"/> IX-MV7-* <input type="checkbox"/> IXG-DM7(-*) <input type="checkbox"/> IX-DA, IX-DB <input type="checkbox"/> IX-BA, IX-BB <input type="checkbox"/> IX-DV, IX-DVF(-*) <input type="checkbox"/> IX-SSA(-*) <input type="checkbox"/> IX-EA, IX-EAU <input type="checkbox"/> IX-FA <input type="checkbox"/> IXGW-LC <input type="checkbox"/> IXGW-(T)GW <input type="checkbox"/> Intercom App <input type="checkbox"/> IX-SS-2G <input type="checkbox"/> IX-RS-* <input checked="" type="checkbox"/> IX-SOFT <input type="checkbox"/> IXW-MA <input type="checkbox"/> IX-SPMIC <input type="checkbox"/> VoIP Phone <input type="checkbox"/> IX-DVM
Description	<p>Configure the transfer destination station (station number) or the Intercom App and phone call destination when performing schedule transfer again for a transferred call. A single transfer destination station, or single unit containing the Intercom App or phone, can be configured for each of the 12 day schedules. However, if the call originating station is IX-DA, IX-DB, IX-BA, IX-BB, the call will be received without being retransferred.</p> <p>Enter the station number manually, or click [Select Station] to select one. To configure Mobile Apps and Phones, click "Mobile Apps and Phone" - [Select] to select one.</p>
Settings	-

■ Start Time

Compatible type	<input type="checkbox"/> IXG-2C7(-*) <input checked="" type="checkbox"/> IXG-MK <input checked="" type="checkbox"/> IX-MV7-* <input type="checkbox"/> IXG-DM7(-*) <input type="checkbox"/> IX-DA, IX-DB <input type="checkbox"/> IX-BA, IX-BB <input type="checkbox"/> IX-DV, IX-DVF(-*) <input type="checkbox"/> IX-SSA(-*) <input type="checkbox"/> IX-EA, IX-EAU <input type="checkbox"/> IX-FA <input type="checkbox"/> IXGW-LC <input type="checkbox"/> IXGW-(T)GW <input type="checkbox"/> Intercom App <input type="checkbox"/> IX-SS-2G <input type="checkbox"/> IX-RS-* <input checked="" type="checkbox"/> IX-SOFT <input type="checkbox"/> IXW-MA <input type="checkbox"/> IX-SPMIC <input type="checkbox"/> VoIP Phone <input type="checkbox"/> IX-DVM
Description	Set the Start Time to enable schedule transfer.
Settings	00:00 - 23:59

■ End Time

Compatible type	<input type="checkbox"/> IXG-2C7(-*) <input checked="" type="checkbox"/> IXG-MK <input checked="" type="checkbox"/> IX-MV7-* <input type="checkbox"/> IXG-DM7(-*) <input type="checkbox"/> IX-DA, IX-DB <input type="checkbox"/> IX-BA, IX-BB <input type="checkbox"/> IX-DV, IX-DVF(-*) <input type="checkbox"/> IX-SSA(-*) <input type="checkbox"/> IX-EA, IX-EAU <input type="checkbox"/> IX-FA <input type="checkbox"/> IXGW-LC <input type="checkbox"/> IXGW-(T)GW <input type="checkbox"/> Intercom App <input type="checkbox"/> IX-SS-2G <input type="checkbox"/> IX-RS-* <input checked="" type="checkbox"/> IX-SOFT <input type="checkbox"/> IXW-MA <input type="checkbox"/> IX-SPMIC <input type="checkbox"/> VoIP Phone <input type="checkbox"/> IX-DVM
Description	Configure the time at which to end schedule transfer. If set earlier than "Start Time," the end time will be that time on the following day.
Settings	00:00 - 23:59

10.4 Lock Transfer

Move row

Up to 50 station number rows can be displayed at a time. Switch the screen as follows.

[Previous]: Display the previous 50 rows.

[Next]: Display the next 50 rows.

[Apply]: Enter the station number and click **[Apply]** to move the cursor to the row of the station number that was entered.

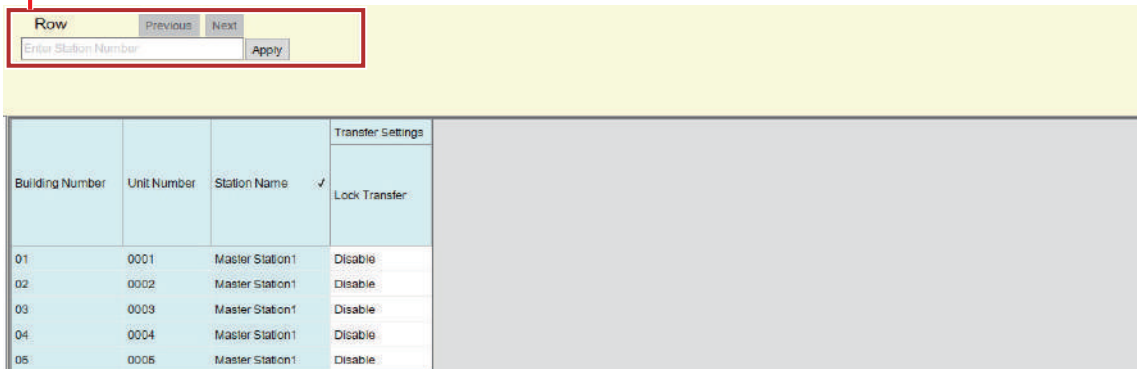

Compatible type	<input type="checkbox"/> IXG-2C7(-*) <input type="checkbox"/> IXG-MK <input checked="" type="checkbox"/> IX-MV7-* <input type="checkbox"/> IXG-DM7(-*) <input type="checkbox"/> IX-DA, IX-DB <input type="checkbox"/> IX-BA, IX-BB <input type="checkbox"/> IX-DV, IX-DVF(-*) <input type="checkbox"/> IX-SSA(-*) <input type="checkbox"/> IX-EA, IX-EAU <input type="checkbox"/> IX-FA <input type="checkbox"/> IXGW-LC <input type="checkbox"/> IXGW-(T)GW <input type="checkbox"/> Intercom App <input type="checkbox"/> IX-SS-2G <input type="checkbox"/> IX-RS-* <input checked="" type="checkbox"/> IX-SOFT <input type="checkbox"/> IXW-MA <input type="checkbox"/> IX-SPMIC <input type="checkbox"/> VoIP Phone <input type="checkbox"/> IX-DVM
Description	Configure whether to restrict transfer settings. If this is set to "Enable," transfer settings cannot be changed under general (user) privileges.
Settings	<ul style="list-style-type: none"> • Enable: Cannot be configured under general (user) privileges. • Disable: Can be configured under general (user) privileges. For IXG-MK, change the setting on the screen of the station.

10.5 Reception Call Settings

Configure reception call function settings.

Reception call function: Allows outgoing calls sent from the Entrance Station to a residence or tenant to be temporarily received by the Guard Station. It can then be transmitted to the resident once the visitor has been confirmed.

Select the Building Number / Building Name in "Filter," select the Unit Number (up to 100 units at once), and then click **[Apply]**. The following screen is displayed.

Filter
 Building Number / Building Name: Select the building containing the call destination performing reception calling to display.
 Unit Number: Select the Unit Number (100 units at once) of the call destination performing reception calling to display, and then click **[Apply]**. The Settings screen for the selected unit is displayed.

["How to configure reception call batch settings \(→page 233\)"](#)

List of call destination units performing reception calling

10.5.1 Reception Call Settings

Compatible type	<input type="checkbox"/> IXG-2C7(-*) <input type="checkbox"/> IXG-MK <input type="checkbox"/> IX-MV7-* <input checked="" type="checkbox"/> IXG-DM7(-*) <input type="checkbox"/> IX-DA, IX-DB <input type="checkbox"/> IX-BA, IX-BB <input type="checkbox"/> IX-DV, IX-DVF(-*) <input type="checkbox"/> IX-SSA(-*) <input type="checkbox"/> IX-EA, IX-EAU <input type="checkbox"/> IX-FA <input type="checkbox"/> IXGW-LC <input type="checkbox"/> IXGW-(T)GW <input type="checkbox"/> Intercom App <input type="checkbox"/> IX-SS-2G <input type="checkbox"/> IX-RS-* <input type="checkbox"/> IX-SOFT <input type="checkbox"/> IXW-MA <input type="checkbox"/> IX-SPMIC <input type="checkbox"/> VoIP Phone <input type="checkbox"/> IX-DVM
Description	Configure the Guard Station to perform reception calling for outgoing calls sent from the Entrance Station for each unit or tenant. This can be configured for each Entrance Station. To configure a guard office, click [Select] to select one.
Settings	Guard office where IXG-MK is registered

How to configure reception call batch settings

Click **[Reception Call Batch Settings]** to display the following screen.

The screenshot shows a window titled "IXG Support Tool - [Reception Call Batch Settings]". The main heading is "Reception Call Batch Settings".

1. Entrance Selection: This section contains two radio buttons: "All" (which is selected) and "Specify Entrance Station". Below these are two buttons: "Select" and "None Selected".

2. Unit Selection for Reception Call Transfer: This section contains two buttons: "Select" and "None Selected".

3. Reception Call Destination: This section contains a table with the following columns: "Building Nu", "Unit Number", "Unit Name", and "Select Unit". Below the table is a "Select" button.

4. Execute and Cancel: At the bottom right, there are two buttons: "Execute" and "Cancel".

- 1.** Select the call originating Entrance Station.
 - All
 - Specify Entrance Station: Select the Entrance Station to configure. Click **[Select]** to set the Entrance Station.
- 2.** Select the call destination residence/tenant.
 - Click **[Select]** to set Residential/Commercial.
- 3.** Select the guard office to receive reception calls.
 - Click **[Select]** to set the guard office to receive reception calls.
- 4.** Click **[Execute]**.
 - Click **[Cancel]** to quit without configuring batch settings.

10.6 Reception Button Settings

Compatible type	<input type="checkbox"/> IXG-2C7(-*) <input checked="" type="checkbox"/> IXG-MK <input type="checkbox"/> IX-MV7-* <input type="checkbox"/> IXG-DM7(-*) <input type="checkbox"/> IX-DA, IX-DB <input type="checkbox"/> IX-BA, IX-BB <input type="checkbox"/> IX-DV, IX-DVF(-*) <input type="checkbox"/> IX-SSA(-*) <input type="checkbox"/> IX-EA, IX-EAU <input type="checkbox"/> IX-FA <input type="checkbox"/> IXGW-LC <input type="checkbox"/> IXGW-(T)GW <input type="checkbox"/> Intercom App <input type="checkbox"/> IX-SS-2G <input type="checkbox"/> IX-RS-* <input type="checkbox"/> IX-SOFT <input type="checkbox"/> IXW-MA <input type="checkbox"/> IX-SPMIC <input type="checkbox"/> VoIP Phone <input type="checkbox"/> IX-DVM
-----------------	---

Use the **[RECEPTION ON/OFF]** button on IXG-MK to configure the Entrance Station to switch the call reception mode.

Up to 500 Entrance Stations can be set for each guard office.

Reception Mode Button Display Settings

Move to ["Display Mode \(→page 209\)"](#). To use call reception mode, set the "Reception Mode Button" to "Enable."

[Related Settings]

Reception Mode Button Display Settings

			Transfer Settings		
			Reception Button Settings		
Building Number	Unit Number	Unit Name	Building Number01		
			001 / Entrance001	001 / Entrance001	4444 / Entrance4444
			010010 / Entrance Station1	010011 / Entrance Station2	0144440 / Entrance Station1
01	201	Guard201			
01	444	Guard444			

List of guard offices with registered IXG-MK

List of Entrance Stations

How to configure

1. Search for the unit to configure from the "List of guard offices containing IXG-MK."
2. Search for the station to configure from "List of Entrance Stations."
3. Click the cell that corresponds to Steps 1 and 2.
 - Select: Set the Entrance Station with "✓" selected.
4. After configuration is complete, click **[Update]**.
5. Click **[OK]**.

11. Station Settings (Advanced Settings)

11.1 Speed Dials

Configure speed dial button settings for IXG-MK, IX-MV7-*, or IX-SOFT.
 Select the speed dial number to configure in **[Display settings]**.

Move row
 Up to 50 station number rows can be displayed at a time. Switch the screen as follows.
[Previous]: Display the previous 50 rows.
[Next]: Display the next 50 rows.
[Apply]: Enter the station number and click **[Apply]** to move the cursor to the row of the station number that was entered.

Display settings
 Settings for the selected Speed Dial button number are displayed.

Building Number	Unit Number	Station Name	Station Settings									
			Speed Dials									
			Speed Dial 1	Individual Call			Group Call			Group Page		
Speed Dial Button Name	Function	Station Number	Select Station	Priority	Number	Open	Priority	Number	Open			
01	444	Guard Station1	No Function		Select Station			Open			Open	
01	0001	Master Station1	No Function		Select Station			Open			Open	
01	202	Master Station1	No Function		Select Station			Open			Open	
02	0002	Master Station1	No Function		Select Station			Open			Open	
03	0003	Master Station1	No Function		Select Station			Open			Open	
04	0004	Master Station1	No Function		Select Station			Open			Open	
05	0005	Master Station1	No Function		Select Station			Open			Open	

11.1.1 Advanced Speed Dial Button Settings

Select the functions to assign to each Speed Dial button. Up to 8 (IX-MV7-* and IXG-MK) or 50 (IX-SOFT) speed dial buttons can be set.

11.1.1.1 Speed Dial Button Name

Compatible type	<input type="checkbox"/> IXG-2C7(-*) <input checked="" type="checkbox"/> IXG-MK <input checked="" type="checkbox"/> IX-MV7-* <input type="checkbox"/> IXG-DM7(-*) <input type="checkbox"/> IX-DA, IX-DB <input type="checkbox"/> IX-BA, IX-BB <input type="checkbox"/> IX-DV, IX-DVF(-*) <input type="checkbox"/> IX-SSA(-*) <input type="checkbox"/> IX-EA, IX-EAU <input type="checkbox"/> IX-FA <input type="checkbox"/> IXGW-LC <input type="checkbox"/> IXGW-(T)GW <input type="checkbox"/> Intercom App <input type="checkbox"/> IX-SS-2G <input type="checkbox"/> IX-RS-* <input checked="" type="checkbox"/> IX-SOFT <input type="checkbox"/> IXW-MA <input type="checkbox"/> IX-SPMIC <input type="checkbox"/> VoIP Phone <input type="checkbox"/> IX-DVM
Description	Set the Speed Dial Name.
Settings	1-24 alphanumeric characters The entire name may not be shown on the station screen, depending on the number of characters.

! Important

- Enter button names using the language configured in "[Language \(→page 91\)](#)". However, if the language (configured on the station main unit) displayed on the screen for a station is different from the language set with "Language," text displayed on the station screen may appear incorrectly. To avoid this, enter information using alphabetical characters only.

11.1.1.2 Function

Compatible type	<input type="checkbox"/> IXG-2C7(-*) <input checked="" type="checkbox"/> IXG-MK <input checked="" type="checkbox"/> IX-MV7-* <input type="checkbox"/> IXG-DM7(-*) <input type="checkbox"/> IX-DA, IX-DB <input type="checkbox"/> IX-BA, IX-BB <input type="checkbox"/> IX-DV, IX-DVF(-*) <input type="checkbox"/> IX-SSA(-*) <input type="checkbox"/> IX-EA, IX-EAU <input type="checkbox"/> IX-FA <input type="checkbox"/> IXGW-LC <input type="checkbox"/> IXGW-(T)GW <input type="checkbox"/> Intercom App <input type="checkbox"/> IX-SS-2G <input type="checkbox"/> IX-RS-* <input checked="" type="checkbox"/> IX-SOFT <input type="checkbox"/> IXW-MA <input type="checkbox"/> IX-SPMIC <input type="checkbox"/> VoIP Phone <input type="checkbox"/> IX-DVM
Description	Set the speed dial button functions. The functions that can be selected vary by station. Refer to the information beginning in " How to configure Individual Call (→page 236) " for details on how to configure functions.
Settings	<ul style="list-style-type: none"> No Function Group Call (IX-MV7-* and IX-SOFT only): Make a group call. Individual Call (IX-MV7-* and IX-SOFT only): Make an individual call. Group Page (IX-MV7-* and IX-SOFT only): Send a group page. All Page: Send an all page. Group Message Page (IX-MV7-* and IX-SOFT only): Send a group message page. All Message Page: Send an all message page. Monitoring: Perform Monitoring. Network Camera Monitor: Perform Network Camera Monitor. Scan Monitoring: Perform scan monitoring. Option Relay Control: Control the relay output of another station. Contact output control cannot be performed for IXG-2C7(-*), IX-DA, IX-DB, IX-BA, IX-BB. Building Page (IXG-MK only): Send a building page. Building Message Page (IXG-MK only): Send a building message page. Unit Call (IXG-MK only): Call a unit.

How to configure Individual Call

Configure this if "Speed Dials" - "[Function \(→page 236\)](#)" was set to "Individual Call."

■ Station Number

Compatible type	<input type="checkbox"/> IXG-2C7(-*) <input type="checkbox"/> IXG-MK <input checked="" type="checkbox"/> IX-MV7-* <input type="checkbox"/> IXG-DM7(-*) <input type="checkbox"/> IX-DA, IX-DB <input type="checkbox"/> IX-BA, IX-BB <input type="checkbox"/> IX-DV, IX-DVF(-*) <input type="checkbox"/> IX-SSA(-*) <input type="checkbox"/> IX-EA, IX-EAU <input type="checkbox"/> IX-FA <input type="checkbox"/> IXGW-LC <input type="checkbox"/> IXGW-(T)GW <input type="checkbox"/> Intercom App <input type="checkbox"/> IX-SS-2G <input type="checkbox"/> IX-RS-* <input checked="" type="checkbox"/> IX-SOFT <input type="checkbox"/> IXW-MA <input type="checkbox"/> IX-SPMIC <input type="checkbox"/> VoIP Phone <input type="checkbox"/> IX-DVM
Description	Configure the call destination station (station number). Enter the station number manually, or click [Select Station] to select one. Cannot be set for IXW-MA.
Settings	—

! Important

- Stations in which "IP Address" has not been configured in Administrator mode cannot be configured as a call destination.

■ Priority

Compatible type	<input type="checkbox"/> IXG-2C7(-*) <input type="checkbox"/> IXG-MK <input checked="" type="checkbox"/> IX-MV7-* <input type="checkbox"/> IXG-DM7(-*) <input type="checkbox"/> IX-DA, IX-DB <input type="checkbox"/> IX-BA, IX-BB <input type="checkbox"/> IX-DV, IX-DVF(-*) <input type="checkbox"/> IX-SSA(-*) <input type="checkbox"/> IX-EA, IX-EAU <input type="checkbox"/> IX-FA <input type="checkbox"/> IXGW-LC <input type="checkbox"/> IXGW-(T)GW <input type="checkbox"/> Intercom App <input type="checkbox"/> IX-SS-2G <input type="checkbox"/> IX-RS-* <input checked="" type="checkbox"/> IX-SOFT <input type="checkbox"/> IXW-MA <input type="checkbox"/> IX-SPMIC <input type="checkbox"/> VoIP Phone <input type="checkbox"/> IX-DVM
Description	Set the Priority for the individual calls.
Settings	<ul style="list-style-type: none"> • Normal • Priority • Urgent

How to configure Group Call

Configure this if "Speed Dials" - "[Function \(→page 236\)](#)" was set to "Group Call."

■ Number

Compatible type	<input type="checkbox"/> IXG-2C7(-*) <input type="checkbox"/> IXG-MK <input checked="" type="checkbox"/> IX-MV7-* <input type="checkbox"/> IXG-DM7(-*) <input type="checkbox"/> IX-DA, IX-DB <input type="checkbox"/> IX-BA, IX-BB <input type="checkbox"/> IX-DV, IX-DVF(-*) <input type="checkbox"/> IX-SSA(-*) <input type="checkbox"/> IX-EA, IX-EAU <input type="checkbox"/> IX-FA <input type="checkbox"/> IXGW-LC <input type="checkbox"/> IXGW-(T)GW <input type="checkbox"/> Intercom App <input type="checkbox"/> IX-SS-2G <input type="checkbox"/> IX-RS-* <input checked="" type="checkbox"/> IX-SOFT <input type="checkbox"/> IXW-MA <input type="checkbox"/> IX-SPMIC <input type="checkbox"/> VoIP Phone <input type="checkbox"/> IX-DVM
Description	Set the destination group. Enter the group number manually, or click [Open] to select one.
Settings	01 - 99

■ Priority

Compatible type	<input type="checkbox"/> IXG-2C7(-*) <input type="checkbox"/> IXG-MK <input checked="" type="checkbox"/> IX-MV7-* <input type="checkbox"/> IXG-DM7(-*) <input type="checkbox"/> IX-DA, IX-DB <input type="checkbox"/> IX-BA, IX-BB <input type="checkbox"/> IX-DV, IX-DVF(-*) <input type="checkbox"/> IX-SSA(-*) <input type="checkbox"/> IX-EA, IX-EAU <input type="checkbox"/> IX-FA <input type="checkbox"/> IXGW-LC <input type="checkbox"/> IXGW-(T)GW <input type="checkbox"/> Intercom App <input type="checkbox"/> IX-SS-2G <input type="checkbox"/> IX-RS-* <input checked="" type="checkbox"/> IX-SOFT <input type="checkbox"/> IXW-MA <input type="checkbox"/> IX-SPMIC <input type="checkbox"/> VoIP Phone <input type="checkbox"/> IX-DVM
Description	Set the priority of Group call.
Settings	<ul style="list-style-type: none"> • Normal • Priority • Urgent

How to configure Group Page

Configure this if "Speed Dials" - "[Function \(→page 236\)](#)" was set to "Group Page."

■ Number

Compatible type	<input type="checkbox"/> IXG-2C7(-*) <input type="checkbox"/> IXG-MK <input checked="" type="checkbox"/> IX-MV7-* <input type="checkbox"/> IXG-DM7(-*) <input type="checkbox"/> IX-DA, IX-DB <input type="checkbox"/> IX-BA, IX-BB <input type="checkbox"/> IX-DV, IX-DVF(-*) <input type="checkbox"/> IX-SSA(-*) <input type="checkbox"/> IX-EA, IX-EAU <input type="checkbox"/> IX-FA <input type="checkbox"/> IXGW-LC <input type="checkbox"/> IXGW-(T)GW <input type="checkbox"/> Intercom App <input type="checkbox"/> IX-SS-2G <input type="checkbox"/> IX-RS-* <input checked="" type="checkbox"/> IX-SOFT <input type="checkbox"/> IXW-MA <input type="checkbox"/> IX-SPMIC <input type="checkbox"/> VoIP Phone <input type="checkbox"/> IX-DVM
Description	Set the destination group. Enter the group number manually, or click [Open] to select one.
Settings	01 - 99

■ Priority

Compatible type	<input type="checkbox"/> IXG-2C7(-*) <input type="checkbox"/> IXG-MK <input checked="" type="checkbox"/> IX-MV7-* <input type="checkbox"/> IXG-DM7(-*) <input type="checkbox"/> IX-DA, IX-DB <input type="checkbox"/> IX-BA, IX-BB <input type="checkbox"/> IX-DV, IX-DVF(-*) <input type="checkbox"/> IX-SSA(-*) <input type="checkbox"/> IX-EA, IX-EAU <input type="checkbox"/> IX-FA <input type="checkbox"/> IXGW-LC <input type="checkbox"/> IXGW-(T)GW <input type="checkbox"/> Intercom App <input type="checkbox"/> IX-SS-2G <input type="checkbox"/> IX-RS-* <input checked="" type="checkbox"/> IX-SOFT <input type="checkbox"/> IXW-MA <input type="checkbox"/> IX-SPMIC <input type="checkbox"/> VoIP Phone <input type="checkbox"/> IX-DVM
Description	Set the priority for paging.
Settings	<ul style="list-style-type: none"> • Normal • Urgent

How to configure all page

Configure this if "Speed Dials" - "[Function \(→page 236\)](#)" was set to "All Page."

■ Priority

Compatible type	<input type="checkbox"/> IXG-2C7(-*) <input checked="" type="checkbox"/> IXG-MK <input checked="" type="checkbox"/> IX-MV7-* <input type="checkbox"/> IXG-DM7(-*) <input type="checkbox"/> IX-DA, IX-DB <input type="checkbox"/> IX-BA, IX-BB <input type="checkbox"/> IX-DV, IX-DVF(-*) <input type="checkbox"/> IX-SSA(-*) <input type="checkbox"/> IX-EA, IX-EAU <input type="checkbox"/> IX-FA <input type="checkbox"/> IXGW-LC <input type="checkbox"/> IXGW-(T)GW <input type="checkbox"/> Intercom App <input type="checkbox"/> IX-SS-2G <input type="checkbox"/> IX-RS-* <input checked="" type="checkbox"/> IX-SOFT <input type="checkbox"/> IXW-MA <input type="checkbox"/> IX-SPMIC <input type="checkbox"/> VoIP Phone <input type="checkbox"/> IX-DVM
Description	Configure the paging priority.
Settings	<ul style="list-style-type: none"> • Normal • Urgent

■ Recorded Page

Compatible type	<input type="checkbox"/> IXG-2C7(-*) <input checked="" type="checkbox"/> IXG-MK <input type="checkbox"/> IX-MV7-* <input type="checkbox"/> IXG-DM7(-*) <input type="checkbox"/> IX-DA, IX-DB <input type="checkbox"/> IX-BA, IX-BB <input type="checkbox"/> IX-DV, IX-DVF(-*) <input type="checkbox"/> IX-SSA(-*) <input type="checkbox"/> IX-EA, IX-EAU <input type="checkbox"/> IX-FA <input type="checkbox"/> IXGW-LC <input type="checkbox"/> IXGW-(T)GW <input type="checkbox"/> Intercom App <input type="checkbox"/> IX-SS-2G <input type="checkbox"/> IX-RS-* <input type="checkbox"/> IX-SOFT <input type="checkbox"/> IXW-MA <input type="checkbox"/> IX-SPMIC <input type="checkbox"/> VoIP Phone <input type="checkbox"/> IX-DVM
Description	Send a page using audio recorded prior to paging.
Settings	<ul style="list-style-type: none"> • Enable • Disable <p>If there are 501 or more paging destination stations, this will be set to "Enable" and cannot be changed.</p>

How to configure Group Message Page

Configure this if "Speed Dials" - "[Function \(→page 236\)](#)" was set to "Group Message Page."

■ Number

Compatible type	<input type="checkbox"/> IXG-2C7(-*) <input type="checkbox"/> IXG-MK <input checked="" type="checkbox"/> IX-MV7-* <input type="checkbox"/> IXG-DM7(-*) <input type="checkbox"/> IX-DA, IX-DB <input type="checkbox"/> IX-BA, IX-BB <input type="checkbox"/> IX-DV, IX-DVF(-*) <input type="checkbox"/> IX-SSA(-*) <input type="checkbox"/> IX-EA, IX-EAU <input type="checkbox"/> IX-FA <input type="checkbox"/> IXGW-LC <input type="checkbox"/> IXGW-(T)GW <input type="checkbox"/> Intercom App <input type="checkbox"/> IX-SS-2G <input type="checkbox"/> IX-RS-* <input checked="" type="checkbox"/> IX-SOFT <input type="checkbox"/> IXW-MA <input type="checkbox"/> IX-SPMIC <input type="checkbox"/> VoIP Phone <input type="checkbox"/> IX-DVM
Description	Set the destination group. Enter the group number manually, or click [Open] to select one.
Settings	01 - 99

■ Message File Name

Compatible type	<input type="checkbox"/> IXG-2C7(-*) <input type="checkbox"/> IXG-MK <input checked="" type="checkbox"/> IX-MV7-* <input type="checkbox"/> IXG-DM7(-*) <input type="checkbox"/> IX-DA, IX-DB <input type="checkbox"/> IX-BA, IX-BB <input type="checkbox"/> IX-DV, IX-DVF(-*) <input type="checkbox"/> IX-SSA(-*) <input type="checkbox"/> IX-EA, IX-EAU <input type="checkbox"/> IX-FA <input type="checkbox"/> IXGW-LC <input type="checkbox"/> IXGW-(T)GW <input type="checkbox"/> Intercom App <input type="checkbox"/> IX-SS-2G <input type="checkbox"/> IX-RS-* <input checked="" type="checkbox"/> IX-SOFT <input type="checkbox"/> IXW-MA <input type="checkbox"/> IX-SPMIC <input type="checkbox"/> VoIP Phone <input type="checkbox"/> IX-DVM
Description	Select the message (audio file) to be send during group message paging.
Settings	<ul style="list-style-type: none"> • None • Call Pattern 1 • Call Pattern 2 • Call Pattern 3 • Call Pattern 4 • Call Pattern 5 • Call Pattern 6 • Tremolo Sound • Busy Response Tone • On Hold • Operation Sound (except IX-SOFT) • Error • Pre Tone 1 • Pre Tone 2 • Pre Tone 3 • Communication End Pretone • Call Queue Notification • Waiting Reply Tone • Select a sound that is registered in “Custom Sound Registry (→page 117)”.

■ Priority

Compatible type	<input type="checkbox"/> IXG-2C7(-*) <input type="checkbox"/> IXG-MK <input checked="" type="checkbox"/> IX-MV7-* <input type="checkbox"/> IXG-DM7(-*) <input type="checkbox"/> IX-DA, IX-DB <input type="checkbox"/> IX-BA, IX-BB <input type="checkbox"/> IX-DV, IX-DVF(-*) <input type="checkbox"/> IX-SSA(-*) <input type="checkbox"/> IX-EA, IX-EAU <input type="checkbox"/> IX-FA <input type="checkbox"/> IXGW-LC <input type="checkbox"/> IXGW-(T)GW <input type="checkbox"/> Intercom App <input type="checkbox"/> IX-SS-2G <input type="checkbox"/> IX-RS-* <input checked="" type="checkbox"/> IX-SOFT <input type="checkbox"/> IXW-MA <input type="checkbox"/> IX-SPMIC <input type="checkbox"/> VoIP Phone <input type="checkbox"/> IX-DVM
Description	Set the priority for paging.
Settings	<ul style="list-style-type: none"> • Normal • Urgent

■ Ringback Tone Count [time(s)]

Compatible type	<input type="checkbox"/> IXG-2C7(-*) <input type="checkbox"/> IXG-MK <input checked="" type="checkbox"/> IX-MV7-* <input type="checkbox"/> IXG-DM7(-*) <input type="checkbox"/> IX-DA, IX-DB <input type="checkbox"/> IX-BA, IX-BB <input type="checkbox"/> IX-DV, IX-DVF(-*) <input type="checkbox"/> IX-SSA(-*) <input type="checkbox"/> IX-EA, IX-EAU <input type="checkbox"/> IX-FA <input type="checkbox"/> IXGW-LC <input type="checkbox"/> IXGW-(T)GW <input type="checkbox"/> Intercom App <input type="checkbox"/> IX-SS-2G <input type="checkbox"/> IX-RS-* <input checked="" type="checkbox"/> IX-SOFT <input type="checkbox"/> IXW-MA <input type="checkbox"/> IX-SPMIC <input type="checkbox"/> VoIP Phone <input type="checkbox"/> IX-DVM
Description	Set the message play count of group message page.
Settings	1-20 times

How to configure All Message Page

Configure this if "Speed Dials" - "[Function \(→page 236\)](#)" was set to "All Message Page."

■ Message File Name

Compatible type	<input type="checkbox"/> IXG-2C7(-*) <input checked="" type="checkbox"/> IXG-MK <input checked="" type="checkbox"/> IX-MV7-* <input type="checkbox"/> IXG-DM7(-*) <input type="checkbox"/> IX-DA, IX-DB <input type="checkbox"/> IX-BA, IX-BB <input type="checkbox"/> IX-DV, IX-DVF(-*) <input type="checkbox"/> IX-SSA(-*) <input type="checkbox"/> IX-EA, IX-EAU <input type="checkbox"/> IX-FA <input type="checkbox"/> IXGW-LC <input type="checkbox"/> IXGW-(T)GW <input type="checkbox"/> Intercom App <input type="checkbox"/> IX-SS-2G <input type="checkbox"/> IX-RS-* <input checked="" type="checkbox"/> IX-SOFT <input type="checkbox"/> IXW-MA <input type="checkbox"/> IX-SPMIC <input type="checkbox"/> VoIP Phone <input type="checkbox"/> IX-DVM
Description	Select the message (audio file) to send during ALL Message Page.
Settings	<ul style="list-style-type: none"> • None • Call Pattern 1 • Call Pattern 2 • Call Pattern 3 • Call Pattern 4 • Call Pattern 5 • Call Pattern 6 • Tremolo Sound • Busy Response Tone • On Hold • Operation Sound (except IX-SOFT) • Error • Pre Tone 1 • Pre Tone 2 • Pre Tone 3 • Communication End Pretone • Call Queue Notification • Waiting Reply Tone • Select a sound that is registered in "Custom Sound Registry (→page 117)".

■ Priority

Compatible type	<input type="checkbox"/> IXG-2C7(-*) <input checked="" type="checkbox"/> IXG-MK <input checked="" type="checkbox"/> IX-MV7-* <input type="checkbox"/> IXG-DM7(-*) <input type="checkbox"/> IX-DA, IX-DB <input type="checkbox"/> IX-BA, IX-BB <input type="checkbox"/> IX-DV, IX-DVF(-*) <input type="checkbox"/> IX-SSA(-*) <input type="checkbox"/> IX-EA, IX-EAU <input type="checkbox"/> IX-FA <input type="checkbox"/> IXGW-LC <input type="checkbox"/> IXGW-(T)GW <input type="checkbox"/> Intercom App <input type="checkbox"/> IX-SS-2G <input type="checkbox"/> IX-RS-* <input checked="" type="checkbox"/> IX-SOFT <input type="checkbox"/> IXW-MA <input type="checkbox"/> IX-SPMIC <input type="checkbox"/> VoIP Phone <input type="checkbox"/> IX-DVM
Description	Configure the All Message Paging priority.
Settings	<ul style="list-style-type: none"> • Normal • Urgent

■ Ringback Tone Count [time(s)]

Compatible type	<input type="checkbox"/> IXG-2C7(-*) <input checked="" type="checkbox"/> IXG-MK <input checked="" type="checkbox"/> IX-MV7-* <input type="checkbox"/> IXG-DM7(-*) <input type="checkbox"/> IX-DA, IX-DB <input type="checkbox"/> IX-BA, IX-BB <input type="checkbox"/> IX-DV, IX-DVF(-*) <input type="checkbox"/> IX-SSA(-*) <input type="checkbox"/> IX-EA, IX-EAU <input type="checkbox"/> IX-FA <input type="checkbox"/> IXGW-LC <input type="checkbox"/> IXGW-(T)GW <input type="checkbox"/> Intercom App <input type="checkbox"/> IX-SS-2G <input type="checkbox"/> IX-RS-* <input checked="" type="checkbox"/> IX-SOFT <input type="checkbox"/> IXW-MA <input type="checkbox"/> IX-SPMIC <input type="checkbox"/> VoIP Phone <input type="checkbox"/> IX-DVM
Description	Configure the number of times to play the message configured for the "Message File Name."
Settings	1 - 20 times

How to configure Monitoring

Configure this if "Speed Dials" - ["Function \(→page 236\)"](#) was set to "Monitoring."

■ Station Number

Compatible type	<input type="checkbox"/> IXG-2C7(-*) <input checked="" type="checkbox"/> IXG-MK <input checked="" type="checkbox"/> IX-MV7-* <input type="checkbox"/> IXG-DM7(-*) <input type="checkbox"/> IX-DA, IX-DB <input type="checkbox"/> IX-BA, IX-BB <input type="checkbox"/> IX-DV, IX-DVF(-*) <input type="checkbox"/> IX-SSA(-*) <input type="checkbox"/> IX-EA, IX-EAU <input type="checkbox"/> IX-FA <input type="checkbox"/> IXGW-LC <input type="checkbox"/> IXGW-(T)GW <input type="checkbox"/> Intercom App <input type="checkbox"/> IX-SS-2G <input type="checkbox"/> IX-RS-* <input checked="" type="checkbox"/> IX-SOFT <input type="checkbox"/> IXW-MA <input type="checkbox"/> IX-SPMIC <input type="checkbox"/> VoIP Phone <input type="checkbox"/> IX-DVM
Description	Set the station (station number) to monitor. Enter the station number manually, or click [Select Station] to select one. For IXG-MK, only IXG-DM7(-*), IX-RS-*, door stations in the same unit, or door stations in the outside common area can be set. For IX-MV7-* and IX-SOFT, only IXG-DM7(-*), IX-RS-*, or Door Stations in the same unit can be set.
Settings	-



Important

- Stations in which "IP Address" has not been configured in Administrator mode cannot be configured to be monitored.

How to configure Network Camera Monitor

Configure this if "Speed Dials" - ["Function \(→page 236\)"](#) was set to "Network Camera Monitor."

■ Network Camera

Compatible type	<input type="checkbox"/> IXG-2C7(-*) <input checked="" type="checkbox"/> IXG-MK <input checked="" type="checkbox"/> IX-MV7-* <input type="checkbox"/> IXG-DM7(-*) <input type="checkbox"/> IX-DA, IX-DB <input type="checkbox"/> IX-BA, IX-BB <input type="checkbox"/> IX-DV, IX-DVF(-*) <input type="checkbox"/> IX-SSA(-*) <input type="checkbox"/> IX-EA, IX-EAU <input type="checkbox"/> IX-FA <input type="checkbox"/> IXGW-LC <input type="checkbox"/> IXGW-(T)GW <input type="checkbox"/> Intercom App <input type="checkbox"/> IX-SS-2G <input type="checkbox"/> IX-RS-* <input checked="" type="checkbox"/> IX-SOFT <input type="checkbox"/> IXW-MA <input type="checkbox"/> IX-SPMIC <input type="checkbox"/> VoIP Phone <input type="checkbox"/> IX-DVM
Description	Set the network camera (number) to monitor. Directly enter the network camera number configured in "Network Camera List (→page 109)" or click [Network Camera Selection] and select.
Settings	-

How to configure option relays

Configure this if "Speed Dials" - ["Function \(→page 236\)"](#) was set to "Option Relay Control."



Note

- When controlling relay output for multiple stations, processing may take some time and control may be delayed.

■ Total

Compatible type	<input type="checkbox"/> IXG-2C7(-*) <input checked="" type="checkbox"/> IXG-MK <input checked="" type="checkbox"/> IX-MV7-* <input type="checkbox"/> IXG-DM7(-*) <input type="checkbox"/> IX-DA, IX-DB <input type="checkbox"/> IX-BA, IX-BB <input type="checkbox"/> IX-DV, IX-DVF(-*) <input type="checkbox"/> IX-SSA(-*) <input type="checkbox"/> IX-EA, IX-EAU <input type="checkbox"/> IX-FA <input type="checkbox"/> IXGW-LC <input type="checkbox"/> IXGW-(T)GW <input type="checkbox"/> Intercom App <input type="checkbox"/> IX-SS-2G <input type="checkbox"/> IX-RS-* <input checked="" type="checkbox"/> IX-SOFT <input type="checkbox"/> IXW-MA <input type="checkbox"/> IX-SPMIC <input type="checkbox"/> VoIP Phone <input type="checkbox"/> IX-DVM
Description	Configure a station to control relay output. For IXG-MK, only IXG-DM7(-*), IX-MV7-*, IX-RS-*, door stations in the same unit, or door stations in the outside common area can be set. For IX-MV7-* and IX-SOFT, only IXG-DM7(-*), IX-MV7-*, IXG-MK, IX-RS-*, or Door Stations in the same unit can be set. Click [Select Station] to select one. Up to 500 stations can be selected.
Settings	The number of selected stations is displayed.

! Important

- Stations in which "IP Address" has not been configured in Administrator mode cannot be configured as stations to perform control.

Output Time Range

Compatible type	<input type="checkbox"/> IXG-2C7(-*) <input checked="" type="checkbox"/> IXG-MK <input checked="" type="checkbox"/> IX-MV7-* <input type="checkbox"/> IXG-DM7(-*) <input type="checkbox"/> IX-DA, IX-DB <input type="checkbox"/> IX-BA, IX-BB <input type="checkbox"/> IX-DV, IX-DVF(-*) <input type="checkbox"/> IX-SSA(-*) <input type="checkbox"/> IX-EA, IX-EAU <input type="checkbox"/> IX-FA <input type="checkbox"/> IXGW-LC <input type="checkbox"/> IXGW-(T)GW <input type="checkbox"/> Intercom App <input type="checkbox"/> IX-SS-2G <input type="checkbox"/> IX-RS-* <input checked="" type="checkbox"/> IX-SOFT <input type="checkbox"/> IXW-MA <input type="checkbox"/> IX-SPMIC <input type="checkbox"/> VoIP Phone <input type="checkbox"/> IX-DVM
Description	Select the Output Time Range for relay output.
Settings	<ul style="list-style-type: none"> 0 (Momentary): Press the speed dial button to continue to perform relay output. Press the speed dial button again to stop performing relay output. 200-2000 [msec] 3-600 [sec]

Output Time ◆

Compatible type	<input type="checkbox"/> IXG-2C7(-*) <input checked="" type="checkbox"/> IXG-MK <input checked="" type="checkbox"/> IX-MV7-* <input type="checkbox"/> IXG-DM7(-*) <input type="checkbox"/> IX-DA, IX-DB <input type="checkbox"/> IX-BA, IX-BB <input type="checkbox"/> IX-DV, IX-DVF(-*) <input type="checkbox"/> IX-SSA(-*) <input type="checkbox"/> IX-EA, IX-EAU <input type="checkbox"/> IX-FA <input type="checkbox"/> IXGW-LC <input type="checkbox"/> IXGW-(T)GW <input type="checkbox"/> Intercom App <input type="checkbox"/> IX-SS-2G <input type="checkbox"/> IX-RS-* <input checked="" type="checkbox"/> IX-SOFT <input type="checkbox"/> IXW-MA <input type="checkbox"/> IX-SPMIC <input type="checkbox"/> VoIP Phone <input type="checkbox"/> IX-DVM
Description	Configure the output time for relay output within the range set in "Output Time Range."
Settings	<p>The setting value will be configured as follows according to the information set in "Output Time Range."</p> <ul style="list-style-type: none"> If set to 0 (Momentary): Configuration unnecessary. If set to 200-2000 [msec]: Configure from 200-2000 msec (by 200 msec). If set to 3-600 [sec]: Configure from 3-600 seconds (by 1 sec).

TLS

Compatible type	<input type="checkbox"/> IXG-2C7(-*) <input checked="" type="checkbox"/> IXG-MK <input checked="" type="checkbox"/> IX-MV7-* <input type="checkbox"/> IXG-DM7(-*) <input type="checkbox"/> IX-DA, IX-DB <input type="checkbox"/> IX-BA, IX-BB <input type="checkbox"/> IX-DV, IX-DVF(-*) <input type="checkbox"/> IX-SSA(-*) <input type="checkbox"/> IX-EA, IX-EAU <input type="checkbox"/> IX-FA <input type="checkbox"/> IXGW-LC <input type="checkbox"/> IXGW-(T)GW <input type="checkbox"/> Intercom App <input type="checkbox"/> IX-SS-2G <input type="checkbox"/> IX-RS-* <input checked="" type="checkbox"/> IX-SOFT <input type="checkbox"/> IXW-MA <input type="checkbox"/> IX-SPMIC <input type="checkbox"/> VoIP Phone <input type="checkbox"/> IX-DVM
Description	Configure whether to use encryption for option relay communication. If set to "Enable," configure "Option Relay Control Key" and "Relay Output" - "Option Relay Control Authentication Key" in Administrator mode.
Settings	<ul style="list-style-type: none"> Enable Disable

! Important

- If "TLS" is set to "Enable," control may take some time if there are multiple stations to control.

■ Option Relay Control Key

Compatible type	<input type="checkbox"/> IXG-2C7(-*) <input checked="" type="checkbox"/> IXG-MK <input checked="" type="checkbox"/> IX-MV7-* <input type="checkbox"/> IXG-DM7(-*) <input type="checkbox"/> IX-DA, IX-DB <input type="checkbox"/> IX-BA, IX-BB <input type="checkbox"/> IX-DV, IX-DVF(-*) <input type="checkbox"/> IX-SSA(-*) <input type="checkbox"/> IX-EA, IX-EAU <input type="checkbox"/> IX-FA <input type="checkbox"/> IXGW-LC <input type="checkbox"/> IXGW-(T)GW <input type="checkbox"/> Intercom App <input type="checkbox"/> IX-SS-2G <input type="checkbox"/> IX-RS-* <input checked="" type="checkbox"/> IX-SOFT <input type="checkbox"/> IXW-MA <input type="checkbox"/> IX-SPMIC <input type="checkbox"/> VoIP Phone <input type="checkbox"/> IX-DVM
Description	If "TLS" is set to "Enable," configure the encryption key for option relay communication. Relay output can be controlled when there is a match with the authentication key of the other station set in "Relay Output" - "Option Relay Control Authentication Key" in Administrator mode.
Settings	1-20 digits

How to configure building page

Configure this if "Speed Dials" - "[Function \(→page 236\)](#)" was set to "Building Page."

■ Building Number / Building Name

Compatible type	<input type="checkbox"/> IXG-2C7(-*) <input checked="" type="checkbox"/> IXG-MK <input type="checkbox"/> IX-MV7-* <input type="checkbox"/> IXG-DM7(-*) <input type="checkbox"/> IX-DA, IX-DB <input type="checkbox"/> IX-BA, IX-BB <input type="checkbox"/> IX-DV, IX-DVF(-*) <input type="checkbox"/> IX-SSA(-*) <input type="checkbox"/> IX-EA, IX-EAU <input type="checkbox"/> IX-FA <input type="checkbox"/> IXGW-LC <input type="checkbox"/> IXGW-(T)GW <input type="checkbox"/> Intercom App <input type="checkbox"/> IX-SS-2G <input type="checkbox"/> IX-RS-* <input type="checkbox"/> IX-SOFT <input type="checkbox"/> IXW-MA <input type="checkbox"/> IX-SPMIC <input type="checkbox"/> VoIP Phone <input type="checkbox"/> IX-DVM
Description	Configure the Building Number / Building Name of the paging recipient.
Settings	01/Building 1 - 99/Building 99 Select from buildings registered in "Building Information" in Administrator mode.

■ Priority

Compatible type	<input type="checkbox"/> IXG-2C7(-*) <input checked="" type="checkbox"/> IXG-MK <input type="checkbox"/> IX-MV7-* <input type="checkbox"/> IXG-DM7(-*) <input type="checkbox"/> IX-DA, IX-DB <input type="checkbox"/> IX-BA, IX-BB <input type="checkbox"/> IX-DV, IX-DVF(-*) <input type="checkbox"/> IX-SSA(-*) <input type="checkbox"/> IX-EA, IX-EAU <input type="checkbox"/> IX-FA <input type="checkbox"/> IXGW-LC <input type="checkbox"/> IXGW-(T)GW <input type="checkbox"/> Intercom App <input type="checkbox"/> IX-SS-2G <input type="checkbox"/> IX-RS-* <input type="checkbox"/> IX-SOFT <input type="checkbox"/> IXW-MA <input type="checkbox"/> IX-SPMIC <input type="checkbox"/> VoIP Phone <input type="checkbox"/> IX-DVM
Description	Configure the paging priority.
Settings	<ul style="list-style-type: none"> • Normal • Urgent

■ Recorded Page

Compatible type	<input type="checkbox"/> IXG-2C7(-*) <input checked="" type="checkbox"/> IXG-MK <input type="checkbox"/> IX-MV7-* <input type="checkbox"/> IXG-DM7(-*) <input type="checkbox"/> IX-DA, IX-DB <input type="checkbox"/> IX-BA, IX-BB <input type="checkbox"/> IX-DV, IX-DVF(-*) <input type="checkbox"/> IX-SSA(-*) <input type="checkbox"/> IX-EA, IX-EAU <input type="checkbox"/> IX-FA <input type="checkbox"/> IXGW-LC <input type="checkbox"/> IXGW-(T)GW <input type="checkbox"/> Intercom App <input type="checkbox"/> IX-SS-2G <input type="checkbox"/> IX-RS-* <input type="checkbox"/> IX-SOFT <input type="checkbox"/> IXW-MA <input type="checkbox"/> IX-SPMIC <input type="checkbox"/> VoIP Phone <input type="checkbox"/> IX-DVM
Description	Send a page using audio recorded prior to paging.
Settings	<ul style="list-style-type: none"> • Enable • Disable <p>If there are 501 or more paging destination stations, this will be set to "Enable" and cannot be changed.</p>

How to configure Building Message Page

Configure this if "Speed Dials" - "[Function \(→page 236\)](#)" was set to "Building Message Page."

■ Building Number / Building Name

Compatible type	<input type="checkbox"/> IXG-2C7(-*) <input checked="" type="checkbox"/> IXG-MK <input type="checkbox"/> IX-MV7-* <input type="checkbox"/> IXG-DM7(-*) <input type="checkbox"/> IX-DA, IX-DB <input type="checkbox"/> IX-BA, IX-BB <input type="checkbox"/> IX-DV, IX-DVF(-*) <input type="checkbox"/> IX-SSA(-*) <input type="checkbox"/> IX-EA, IX-EAU <input type="checkbox"/> IX-FA <input type="checkbox"/> IXGW-LC <input type="checkbox"/> IXGW-(T)GW <input type="checkbox"/> Intercom App <input type="checkbox"/> IX-SS-2G <input type="checkbox"/> IX-RS-* <input type="checkbox"/> IX-SOFT <input type="checkbox"/> IXW-MA <input type="checkbox"/> IX-SPMIC <input type="checkbox"/> VoIP Phone <input type="checkbox"/> IX-DVM
Description	Configure the Building Number / Building Name of the paging recipient.
Settings	01/Building 1 - 99/Building 99 Select from buildings registered in "Building Information" in Administrator mode.

■ Message File Name

Compatible type	<input type="checkbox"/> IXG-2C7(-*) <input checked="" type="checkbox"/> IXG-MK <input type="checkbox"/> IX-MV7-* <input type="checkbox"/> IXG-DM7(-*) <input type="checkbox"/> IX-DA, IX-DB <input type="checkbox"/> IX-BA, IX-BB <input type="checkbox"/> IX-DV, IX-DVF(-*) <input type="checkbox"/> IX-SSA(-*) <input type="checkbox"/> IX-EA, IX-EAU <input type="checkbox"/> IX-FA <input type="checkbox"/> IXGW-LC <input type="checkbox"/> IXGW-(T)GW <input type="checkbox"/> Intercom App <input type="checkbox"/> IX-SS-2G <input type="checkbox"/> IX-RS-* <input type="checkbox"/> IX-SOFT <input type="checkbox"/> IXW-MA <input type="checkbox"/> IX-SPMIC <input type="checkbox"/> VoIP Phone <input type="checkbox"/> IX-DVM
Description	Select the message (audio file) to send during building message paging.
Settings	<ul style="list-style-type: none"> • None • Call Pattern 1 • Call Pattern 2 • Call Pattern 3 • Call Pattern 4 • Call Pattern 5 • Call Pattern 6 • Tremolo Sound • Busy Response Tone • On Hold • Operation Sound • Error • Pre Tone 1 • Pre Tone 2 • Pre Tone 3 • Communication End Pretone • Call Queue Notification • Waiting Reply Tone • Select a sound that is registered in "Custom Sound Registry (→page 117)".

■ Priority

Compatible type	<input type="checkbox"/> IXG-2C7(-*) <input checked="" type="checkbox"/> IXG-MK <input type="checkbox"/> IX-MV7-* <input type="checkbox"/> IXG-DM7(-*) <input type="checkbox"/> IX-DA, IX-DB <input type="checkbox"/> IX-BA, IX-BB <input type="checkbox"/> IX-DV, IX-DVF(-*) <input type="checkbox"/> IX-SSA(-*) <input type="checkbox"/> IX-EA, IX-EAU <input type="checkbox"/> IX-FA <input type="checkbox"/> IXGW-LC <input type="checkbox"/> IXGW-(T)GW <input type="checkbox"/> Intercom App <input type="checkbox"/> IX-SS-2G <input type="checkbox"/> IX-RS-* <input type="checkbox"/> IX-SOFT <input type="checkbox"/> IXW-MA <input type="checkbox"/> IX-SPMIC <input type="checkbox"/> VoIP Phone <input type="checkbox"/> IX-DVM
Description	Configure the paging priority.
Settings	<ul style="list-style-type: none"> • Normal • Urgent

■ Ringback Tone Count [time(s)]

Compatible type	<input type="checkbox"/> IXG-2C7(-*) <input checked="" type="checkbox"/> IXG-MK <input type="checkbox"/> IX-MV7-* <input type="checkbox"/> IXG-DM7(-*) <input type="checkbox"/> IX-DA, IX-DB <input type="checkbox"/> IX-BA, IX-BB <input type="checkbox"/> IX-DV, IX-DVF(-*) <input type="checkbox"/> IX-SSA(-*) <input type="checkbox"/> IX-EA, IX-EAU <input type="checkbox"/> IX-FA <input type="checkbox"/> IXGW-LC <input type="checkbox"/> IXGW-(T)GW <input type="checkbox"/> Intercom App <input type="checkbox"/> IX-SS-2G <input type="checkbox"/> IX-RS-* <input type="checkbox"/> IX-SOFT <input type="checkbox"/> IXW-MA <input type="checkbox"/> IX-SPMIC <input type="checkbox"/> VoIP Phone <input type="checkbox"/> IX-DVM
Description	Configure the number of times to play the message configured for the "Message File Name."
Settings	1 - 20 times

How to configure Unit Call

Configure this if "Speed Dials" - "[Function \(→page 236\)](#)" was set to "Unit Call."

■ Select Unit

Compatible type	<input type="checkbox"/> IXG-2C7(-*) <input checked="" type="checkbox"/> IXG-MK <input type="checkbox"/> IX-MV7-* <input type="checkbox"/> IXG-DM7(-*) <input type="checkbox"/> IX-DA, IX-DB <input type="checkbox"/> IX-BA, IX-BB <input type="checkbox"/> IX-DV, IX-DVF(-*) <input type="checkbox"/> IX-SSA(-*) <input type="checkbox"/> IX-EA, IX-EAU <input type="checkbox"/> IX-FA <input type="checkbox"/> IXGW-LC <input type="checkbox"/> IXGW-(T)GW <input type="checkbox"/> Intercom App <input type="checkbox"/> IX-SS-2G <input type="checkbox"/> IX-RS-* <input type="checkbox"/> IX-SOFT <input type="checkbox"/> IXW-MA <input type="checkbox"/> IX-SPMIC <input type="checkbox"/> VoIP Phone <input type="checkbox"/> IX-DVM
Description	Set the call destination unit. Only a single unit can be set as the call destination. Click [Select] to select one. The information (Building Number, Unit Number, and Unit Name) for the set call destination is displayed.
Settings	The unit registered as a call destination in " Station List (→page 104) " and " Mobile App and Phone List (→page 107) ".

■ Priority

Compatible type	<input type="checkbox"/> IXG-2C7(-*) <input checked="" type="checkbox"/> IXG-MK <input type="checkbox"/> IX-MV7-* <input type="checkbox"/> IXG-DM7(-*) <input type="checkbox"/> IX-DA, IX-DB <input type="checkbox"/> IX-BA, IX-BB <input type="checkbox"/> IX-DV, IX-DVF(-*) <input type="checkbox"/> IX-SSA(-*) <input type="checkbox"/> IX-EA, IX-EAU <input type="checkbox"/> IX-FA <input type="checkbox"/> IXGW-LC <input type="checkbox"/> IXGW-(T)GW <input type="checkbox"/> Intercom App <input type="checkbox"/> IX-SS-2G <input type="checkbox"/> IX-RS-* <input type="checkbox"/> IX-SOFT <input type="checkbox"/> IXW-MA <input type="checkbox"/> IX-SPMIC <input type="checkbox"/> VoIP Phone <input type="checkbox"/> IX-DVM
Description	Set the priority of unit calls.
Settings	<ul style="list-style-type: none"> • Normal • Priority • Urgent

11.1.1.3 Lock

Compatible type	<input type="checkbox"/> IXG-2C7(-*) <input checked="" type="checkbox"/> IXG-MK <input checked="" type="checkbox"/> IX-MV7-* <input type="checkbox"/> IXG-DM7(-*) <input type="checkbox"/> IX-DA, IX-DB <input type="checkbox"/> IX-BA, IX-BB <input type="checkbox"/> IX-DV, IX-DVF(-*) <input type="checkbox"/> IX-SSA(-*) <input type="checkbox"/> IX-EA, IX-EAU <input type="checkbox"/> IX-FA <input type="checkbox"/> IXGW-LC <input type="checkbox"/> IXGW-(T)GW <input type="checkbox"/> Intercom App <input type="checkbox"/> IX-SS-2G <input type="checkbox"/> IX-RS-* <input checked="" type="checkbox"/> IX-SOFT <input type="checkbox"/> IXW-MA <input type="checkbox"/> IX-SPMIC <input type="checkbox"/> VoIP Phone <input type="checkbox"/> IX-DVM
Description	Configure whether to restrict speed dial button settings. If this is set to "Enable," speed dial button settings cannot be changed under general (user) privileges.
Settings	<ul style="list-style-type: none"> • Enable: Cannot be configured under general (user) privileges. • Disable: Can be configured under general (user) privileges.

11.2 Privacy

If “Auto Answer (→page 132)” was set to "ON," configure the function that prevents the destination station from hearing/viewing audio or camera images during auto answer.

Move row

Up to 50 station number rows can be displayed at a time. Switch the screen as follows.

[Previous]: Display the previous 50 rows.

[Next]: Display the next 50 rows.

[Apply]: Enter the station number and click **[Apply]** to move the cursor to the row of the station number that was entered.

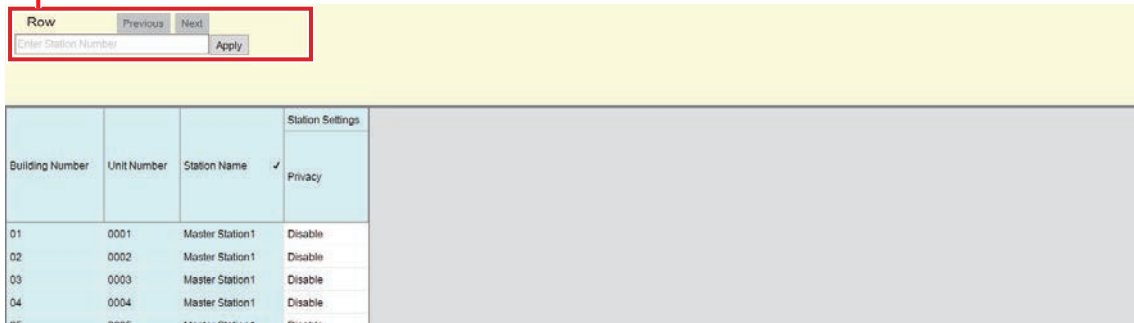

■ Privacy

Compatible type	<input type="checkbox"/> IXG-2C7(-*) <input type="checkbox"/> IXG-MK <input checked="" type="checkbox"/> IX-MV7-* <input type="checkbox"/> IXG-DM7(-*) <input type="checkbox"/> IX-DA, IX-DB <input type="checkbox"/> IX-BA, IX-BB <input type="checkbox"/> IX-DV, IX-DVF(-*) <input type="checkbox"/> IX-SSA(-*) <input type="checkbox"/> IX-EA, IX-EAU <input type="checkbox"/> IX-FA <input type="checkbox"/> IXGW-LC <input type="checkbox"/> IXGW-(T)GW <input type="checkbox"/> Intercom App <input type="checkbox"/> IX-SS-2G <input type="checkbox"/> IX-RS-* <input checked="" type="checkbox"/> IX-SOFT <input type="checkbox"/> IXW-MA <input type="checkbox"/> IX-SPMIC <input type="checkbox"/> VoIP Phone <input type="checkbox"/> IX-DVM
Description	Configure whether to use the privacy function. The setting can also be changed using the button on the station screen. This cannot be set if auto answer is set to "OFF."
Settings	<ul style="list-style-type: none"> • Enable • Disable For IXG-MK, change the setting on the screen of the station.

11.3 Volume / Tone

Configure the sound settings, such as volume and ringtone.

Move row

Up to 50 station number rows can be displayed at a time. Switch the screen as follows.

[Previous]: Display the previous 50 rows.

[Next]: Display the next 50 rows.

[Apply]: Enter the station number and click **[Apply]** to move the cursor to the row of the station number that was entered.

Move to Related Settings

Moves to the selected item within the same Settings screen.

Building No	Unit Number	Station Name	Station Settings									
			Volume / Tone									
			Volume									
			Handset Transmi	Handset Receive	Hands-free Tr	Hands-free Re	Headset Jack Tra	Headset Jack Re	External Input	External Outpu	VoIP Phone Volume Adjustn	Ringtone
01	101	Entrance Station1			10	6					No Adjustment	6
01	102	Tenant Station1	10	6	10	6	10	6			No Adjustment	6
01	102	Video Door Station1			10	6					No Adjustment	6
01	103	Tenant Station1	10	6	10	6	10	6			No Adjustment	6

11.3.1 Volume

■ Handset Transmit

Compatible type	<input type="checkbox"/> IXG-2C7(-*) <input checked="" type="checkbox"/> IXG-MK <input checked="" type="checkbox"/> IX-MV7-* <input type="checkbox"/> IXG-DM7(-*) <input type="checkbox"/> IX-DA, IX-DB <input type="checkbox"/> IX-BA, IX-BB <input type="checkbox"/> IX-DV, IX-DVF(-*) <input type="checkbox"/> IX-SSA(-*) <input type="checkbox"/> IX-EA, IX-EAU <input type="checkbox"/> IX-FA <input type="checkbox"/> IXGW-LC <input type="checkbox"/> IXGW-(T)GW <input type="checkbox"/> Intercom App <input type="checkbox"/> IX-SS-2G <input checked="" type="checkbox"/> IX-RS-* <input type="checkbox"/> IX-SOFT <input type="checkbox"/> IXW-MA <input type="checkbox"/> IX-SPMIC <input type="checkbox"/> VoIP Phone <input type="checkbox"/> IX-DVM
Description	Set the transmit volume using handset while communicating and paging.
Settings	1 (Low) - 10 (High) For IXG-MK, change the setting on the screen of the station.

■ Handset Receive

Compatible type	<input type="checkbox"/> IXG-2C7(-*) <input checked="" type="checkbox"/> IXG-MK <input checked="" type="checkbox"/> IX-MV7-* <input type="checkbox"/> IXG-DM7(-*) <input type="checkbox"/> IX-DA, IX-DB <input type="checkbox"/> IX-BA, IX-BB <input type="checkbox"/> IX-DV, IX-DVF(-*) <input type="checkbox"/> IX-SSA(-*) <input type="checkbox"/> IX-EA, IX-EAU <input type="checkbox"/> IX-FA <input type="checkbox"/> IXGW-LC <input type="checkbox"/> IXGW-(T)GW <input type="checkbox"/> Intercom App <input type="checkbox"/> IX-SS-2G <input checked="" type="checkbox"/> IX-RS-* <input type="checkbox"/> IX-SOFT <input type="checkbox"/> IXW-MA <input type="checkbox"/> IX-SPMIC <input type="checkbox"/> VoIP Phone <input type="checkbox"/> IX-DVM
Description	Set the receive volume on the handset during communication or monitoring. The ringback tone volume will also be changed.
Settings	1 (Low) - 10 (High) For IXG-MK, change the setting on the screen of the station.

■ Hands-free Transmit

Compatible type	<input checked="" type="checkbox"/> IXG-2C7(-*) <input checked="" type="checkbox"/> IXG-MK <input checked="" type="checkbox"/> IX-MV7-* <input checked="" type="checkbox"/> IXG-DM7(-*) <input checked="" type="checkbox"/> IX-DA, IX-DB <input checked="" type="checkbox"/> IX-BA, IX-BB <input checked="" type="checkbox"/> IX-DV, IX-DVF(-*) <input checked="" type="checkbox"/> IX-SSA(-*) <input checked="" type="checkbox"/> IX-EA, IX-EAU <input type="checkbox"/> IX-FA <input type="checkbox"/> IXGW-LC <input type="checkbox"/> IXGW-(T)GW <input type="checkbox"/> Intercom App <input checked="" type="checkbox"/> IX-SS-2G <input checked="" type="checkbox"/> IX-RS-* <input checked="" type="checkbox"/> IX-SOFT <input type="checkbox"/> IXW-MA <input type="checkbox"/> IX-SPMIC <input type="checkbox"/> VoIP Phone <input checked="" type="checkbox"/> IX-DVM
Description	Set the hands-free transmit volume while communicating and paging.
Settings	1 (Low) - 10 (High) IX-SOFT is set to "10" and cannot be changed. For IXG-MK, change the setting on the screen of the station.

■ Hands-free Receive

Compatible type	<input checked="" type="checkbox"/> IXG-2C7(-*) <input checked="" type="checkbox"/> IXG-MK <input checked="" type="checkbox"/> IX-MV7-* <input checked="" type="checkbox"/> IXG-DM7(-*) <input checked="" type="checkbox"/> IX-DA, IX-DB <input checked="" type="checkbox"/> IX-BA, IX-BB <input checked="" type="checkbox"/> IX-DV, IX-DVF(-*) <input checked="" type="checkbox"/> IX-SSA(-*) <input checked="" type="checkbox"/> IX-EA, IX-EAU <input type="checkbox"/> IX-FA <input type="checkbox"/> IXGW-LC <input type="checkbox"/> IXGW-(T)GW <input type="checkbox"/> Intercom App <input checked="" type="checkbox"/> IX-SS-2G <input checked="" type="checkbox"/> IX-RS-* <input checked="" type="checkbox"/> IX-SOFT <input type="checkbox"/> IXW-MA <input type="checkbox"/> IX-SPMIC <input type="checkbox"/> VoIP Phone <input checked="" type="checkbox"/> IX-DVM
Description	Configure the receive volume of the built-in speaker during hands-free communication, monitoring (IXG-2C7(-*), IXG-MK, IX-MV7-*, and IX-SOFT only), or paging (except IXG-DM7(-*), IX-DV, IX-DVF(-*), or IX-SSA(-*)). The ringback tone volume will also be changed.
Settings	1 (Low) - 10 (High) For IXG-2C7(-*) and IXG-MK, change the setting on the screen of the station.

■ Headset Jack Transmit

Compatible type	<input type="checkbox"/> IXG-2C7(-*) <input checked="" type="checkbox"/> IXG-MK <input checked="" type="checkbox"/> IX-MV7-* <input type="checkbox"/> IXG-DM7(-*) <input type="checkbox"/> IX-DA, IX-DB <input type="checkbox"/> IX-BA, IX-BB <input type="checkbox"/> IX-DV, IX-DVF(-*) <input type="checkbox"/> IX-SSA(-*) <input type="checkbox"/> IX-EA, IX-EAU <input type="checkbox"/> IX-FA <input type="checkbox"/> IXGW-LC <input type="checkbox"/> IXGW-(T)GW <input type="checkbox"/> Intercom App <input type="checkbox"/> IX-SS-2G <input type="checkbox"/> IX-RS-* <input type="checkbox"/> IX-SOFT <input type="checkbox"/> IXW-MA <input type="checkbox"/> IX-SPMIC <input type="checkbox"/> VoIP Phone <input type="checkbox"/> IX-DVM
Description	Set the transmit volume using headset jack.
Settings	1 (Low) - 10 (High) For IXG-MK, change the setting on the screen of the station.

■ Headset Jack Receive

Compatible type	<input type="checkbox"/> IXG-2C7(-*) <input checked="" type="checkbox"/> IXG-MK <input checked="" type="checkbox"/> IX-MV7-* <input type="checkbox"/> IXG-DM7(-*) <input type="checkbox"/> IX-DA, IX-DB <input type="checkbox"/> IX-BA, IX-BB <input type="checkbox"/> IX-DV, IX-DVF(-*) <input type="checkbox"/> IX-SSA(-*) <input type="checkbox"/> IX-EA, IX-EAU <input type="checkbox"/> IX-FA <input type="checkbox"/> IXGW-LC <input type="checkbox"/> IXGW-(T)GW <input type="checkbox"/> Intercom App <input type="checkbox"/> IX-SS-2G <input type="checkbox"/> IX-RS-* <input type="checkbox"/> IX-SOFT <input type="checkbox"/> IXW-MA <input type="checkbox"/> IX-SPMIC <input type="checkbox"/> VoIP Phone <input type="checkbox"/> IX-DVM
Description	Set the receive volume using the headset jack.
Settings	1 (Low) - 10 (High) For IXG-MK, change the setting on the screen of the station.

■ External Input

Description	Not used.
-------------	-----------

External Output

Compatible type	<input type="checkbox"/> IXG-2C7(-*) <input type="checkbox"/> IXG-MK <input type="checkbox"/> IX-MV7-* <input type="checkbox"/> IXG-DM7(-*) <input type="checkbox"/> IX-DA, IX-DB <input type="checkbox"/> IX-BA, IX-BB <input type="checkbox"/> IX-DV, IX-DVF(-*) <input type="checkbox"/> IX-SSA(-*) <input type="checkbox"/> IX-EA, IX-EAU <input type="checkbox"/> IX-FA <input type="checkbox"/> IXGW-LC <input type="checkbox"/> IXGW-(T)GW <input type="checkbox"/> Intercom App <input type="checkbox"/> IX-SS-2G <input checked="" type="checkbox"/> IX-RS-* <input type="checkbox"/> IX-SOFT <input type="checkbox"/> IXW-MA <input type="checkbox"/> IX-SPMIC <input type="checkbox"/> VoIP Phone <input type="checkbox"/> IX-DVM
Description	Set the volume output to the external speaker.
Settings	1 (Low) - 10 (High)

VoIP Phone Volume Adjustment

Compatible type	<input checked="" type="checkbox"/> IXG-2C7(-*) <input checked="" type="checkbox"/> IXG-MK <input checked="" type="checkbox"/> IX-MV7-* <input checked="" type="checkbox"/> IXG-DM7(-*) <input checked="" type="checkbox"/> IX-DA, IX-DB <input checked="" type="checkbox"/> IX-BA, IX-BB <input checked="" type="checkbox"/> IX-DV, IX-DVF(-*) <input checked="" type="checkbox"/> IX-SSA(-*) <input checked="" type="checkbox"/> IX-EA, IX-EAU <input type="checkbox"/> IX-FA <input type="checkbox"/> IXGW-LC <input type="checkbox"/> IXGW-(T)GW <input type="checkbox"/> Intercom App <input checked="" type="checkbox"/> IX-SS-2G <input checked="" type="checkbox"/> IX-RS-* <input checked="" type="checkbox"/> IX-SOFT <input type="checkbox"/> IXW-MA <input type="checkbox"/> IX-SPMIC <input type="checkbox"/> VoIP Phone <input checked="" type="checkbox"/> IX-DVM
Description	Adjust the transmit/receive volume balance with the VoIP Phone.
Settings	<ul style="list-style-type: none"> • -12dB from VoIP, +12dB to VoIP • -6dB from VoIP, +6dB to VoIP • No Adjustment • +6dB from VoIP, -6dB to VoIP • +12dB from VoIP, -12dB to VoIP IXG-2C7(-*) is set to "No Adjustment" and cannot be changed.

Ringtone

Compatible type	<input checked="" type="checkbox"/> IXG-2C7(-*) <input checked="" type="checkbox"/> IXG-MK <input checked="" type="checkbox"/> IX-MV7-* <input checked="" type="checkbox"/> IXG-DM7(-*) <input checked="" type="checkbox"/> IX-DA, IX-DB <input checked="" type="checkbox"/> IX-BA, IX-BB <input checked="" type="checkbox"/> IX-DV, IX-DVF(-*) <input checked="" type="checkbox"/> IX-SSA(-*) <input checked="" type="checkbox"/> IX-EA, IX-EAU <input type="checkbox"/> IX-FA <input type="checkbox"/> IXGW-LC <input type="checkbox"/> IXGW-(T)GW <input type="checkbox"/> Intercom App <input checked="" type="checkbox"/> IX-SS-2G <input checked="" type="checkbox"/> IX-RS-* <input checked="" type="checkbox"/> IX-SOFT <input type="checkbox"/> IXW-MA <input type="checkbox"/> IX-SPMIC <input type="checkbox"/> VoIP Phone <input checked="" type="checkbox"/> IX-DVM
Description	Select the volume for Ringtone and Paging Pretone.
Settings	0 (Off), 1 (Low) - 10 (High) For IXG-2C7(-*) and IXG-MK, change the setting on the screen of the station.

Paging

Compatible type	<input type="checkbox"/> IXG-2C7(-*) <input type="checkbox"/> IXG-MK <input type="checkbox"/> IX-MV7-* <input checked="" type="checkbox"/> IXG-DM7(-*) <input type="checkbox"/> IX-DA, IX-DB <input type="checkbox"/> IX-BA, IX-BB <input checked="" type="checkbox"/> IX-DV, IX-DVF(-*) <input checked="" type="checkbox"/> IX-SSA(-*) <input type="checkbox"/> IX-EA, IX-EAU <input type="checkbox"/> IX-FA <input type="checkbox"/> IXGW-LC <input type="checkbox"/> IXGW-(T)GW <input type="checkbox"/> Intercom App <input type="checkbox"/> IX-SS-2G <input type="checkbox"/> IX-RS-* <input type="checkbox"/> IX-SOFT <input type="checkbox"/> IXW-MA <input type="checkbox"/> IX-SPMIC <input type="checkbox"/> VoIP Phone <input type="checkbox"/> IX-DVM
Description	Set the volume while receiving page.
Settings	0 (Off), 1 (Low) - 10 (High)

Button Feedback

Compatible type	<input checked="" type="checkbox"/> IXG-2C7(-*) <input checked="" type="checkbox"/> IXG-MK <input checked="" type="checkbox"/> IX-MV7-* <input type="checkbox"/> IXG-DM7(-*) <input type="checkbox"/> IX-DA, IX-DB <input type="checkbox"/> IX-BA, IX-BB <input type="checkbox"/> IX-DV, IX-DVF(-*) <input type="checkbox"/> IX-SSA(-*) <input type="checkbox"/> IX-EA, IX-EAU <input type="checkbox"/> IX-FA <input type="checkbox"/> IXGW-LC <input type="checkbox"/> IXGW-(T)GW <input type="checkbox"/> Intercom App <input type="checkbox"/> IX-SS-2G <input type="checkbox"/> IX-RS-* <input type="checkbox"/> IX-SOFT <input type="checkbox"/> IXW-MA <input type="checkbox"/> IX-SPMIC <input type="checkbox"/> VoIP Phone <input type="checkbox"/> IX-DVM
Description	Select Enable / Disable for Button Feedback tone.
Settings	<ul style="list-style-type: none"> • Enable • Disable IXG-2C7(-*) is set to "Disable" and cannot be changed. For IXG-MK, change the setting on the screen of the station.

11.3.2 Tone

■ Communication Timeout Notification

Compatible type	<input checked="" type="checkbox"/> IXG-2C7(-*) <input checked="" type="checkbox"/> IXG-MK <input checked="" type="checkbox"/> IX-MV7-* <input checked="" type="checkbox"/> IXG-DM7(-*) <input type="checkbox"/> IX-DA, IX-DB <input type="checkbox"/> IX-BA, IX-BB <input checked="" type="checkbox"/> IX-DV, IX-DVF(-*) <input checked="" type="checkbox"/> IX-SSA(-*) <input checked="" type="checkbox"/> IX-EA, IX-EAU <input type="checkbox"/> IX-FA <input type="checkbox"/> IXGW-LC <input type="checkbox"/> IXGW-(T)GW <input type="checkbox"/> Intercom App <input checked="" type="checkbox"/> IX-SS-2G <input checked="" type="checkbox"/> IX-RS-* <input checked="" type="checkbox"/> IX-SOFT <input type="checkbox"/> IXW-MA <input type="checkbox"/> IX-SPMIC <input type="checkbox"/> VoIP Phone <input checked="" type="checkbox"/> IX-DVM
Description	Select the tone to be played when an outgoing call times out.
Settings	<ul style="list-style-type: none"> • None • Call Pattern 1 • Call Pattern 2 • Call Pattern 3 • Call Pattern 4 • Call Pattern 5 • Call Pattern 6 • Call Pattern 7 (IX-EA and IX-DVM only) • Tremolo Sound • Busy Response Tone • On Hold • Operation Sound (except IX-SOFT) • Error • Pre Tone 1 • Pre Tone 2 • Pre Tone 3 • Communication End Pretone • Call Queue Notification • Waiting Reply Tone • Select a sound that is registered in “Custom Sound Registry (→page 117)”. IXG-2C7(-*) is set to "Error" and cannot be changed.

■ Communication End Pretone

Compatible type	<input checked="" type="checkbox"/> IXG-2C7(-*) <input checked="" type="checkbox"/> IXG-MK <input checked="" type="checkbox"/> IX-MV7-* <input checked="" type="checkbox"/> IXG-DM7(-*) <input type="checkbox"/> IX-DA, IX-DB <input type="checkbox"/> IX-BA, IX-BB <input checked="" type="checkbox"/> IX-DV, IX-DVF(-*) <input checked="" type="checkbox"/> IX-SSA(-*) <input checked="" type="checkbox"/> IX-EA, IX-EAU <input type="checkbox"/> IX-FA <input type="checkbox"/> IXGW-LC <input type="checkbox"/> IXGW-(T)GW <input type="checkbox"/> Intercom App <input checked="" type="checkbox"/> IX-SS-2G <input checked="" type="checkbox"/> IX-RS-* <input checked="" type="checkbox"/> IX-SOFT <input type="checkbox"/> IXW-MA <input type="checkbox"/> IX-SPMIC <input type="checkbox"/> VoIP Phone <input checked="" type="checkbox"/> IX-DVM
Description	Select the tone to be played 10 sec before communication, paging, or monitoring ends.
Settings	<ul style="list-style-type: none"> • None • Call Pattern 1 • Call Pattern 2 • Call Pattern 3 • Call Pattern 4 • Call Pattern 5 • Call Pattern 6 • Call Pattern 7 (IX-EA and IX-DVM only) • Tremolo Sound • Busy Response Tone • On Hold • Operation Sound (except IX-SOFT) • Error • Pre Tone 1 • Pre Tone 2 • Pre Tone 3 • Communication End Pretone • Call Queue Notification • Waiting Reply Tone • Select a sound that is registered in "Custom Sound Registry (→page 117)". IXG-2C7(-*) is set to "Communication End Pretone" and cannot be changed.

■ Call Queue Notification

Compatible type	<input checked="" type="checkbox"/> IXG-2C7(-*) <input checked="" type="checkbox"/> IXG-MK <input checked="" type="checkbox"/> IX-MV7-* <input type="checkbox"/> IXG-DM7(-*) <input type="checkbox"/> IX-DA, IX-DB <input type="checkbox"/> IX-BA, IX-BB <input type="checkbox"/> IX-DV, IX-DVF(-*) <input type="checkbox"/> IX-SSA(-*) <input type="checkbox"/> IX-EA, IX-EAU <input type="checkbox"/> IX-FA <input type="checkbox"/> IXGW-LC <input type="checkbox"/> IXGW-(T)GW <input type="checkbox"/> Intercom App <input type="checkbox"/> IX-SS-2G <input type="checkbox"/> IX-RS-* <input checked="" type="checkbox"/> IX-SOFT <input type="checkbox"/> IXW-MA <input type="checkbox"/> IX-SPMIC <input type="checkbox"/> VoIP Phone <input type="checkbox"/> IX-DVM
Description	Select the tone to be played when receiving a call while communicating.
Settings	<ul style="list-style-type: none"> • None • Call Pattern 1 • Call Pattern 2 • Call Pattern 3 • Call Pattern 4 • Call Pattern 5 • Call Pattern 6 • Tremolo Sound • Busy Response Tone • On Hold • Operation Sound (except IX-SOFT) • Error • Pre Tone 1 • Pre Tone 2 • Pre Tone 3 • Communication End Pretone • Call Queue Notification • Waiting Reply Tone • Select a sound that is registered in "Custom Sound Registry (→page 117)". IXG-2C7(-*) is set to "Call Queue Notification" and cannot be changed.

■ Paging Pretone

Compatible type	<input checked="" type="checkbox"/> IXG-2C7(-*) <input checked="" type="checkbox"/> IXG-MK <input checked="" type="checkbox"/> IX-MV7-* <input type="checkbox"/> IXG-DM7(-*) <input type="checkbox"/> IX-DA, IX-DB <input type="checkbox"/> IX-BA, IX-BB <input type="checkbox"/> IX-DV, IX-DVF(-*) <input type="checkbox"/> IX-SSA(-*) <input type="checkbox"/> IX-EA, IX-EAU <input type="checkbox"/> IX-FA <input type="checkbox"/> IXGW-LC <input type="checkbox"/> IXGW-(T)GW <input type="checkbox"/> Intercom App <input type="checkbox"/> IX-SS-2G <input type="checkbox"/> IX-RS-* <input checked="" type="checkbox"/> IX-SOFT <input type="checkbox"/> IXW-MA <input type="checkbox"/> IX-SPMIC <input type="checkbox"/> VoIP Phone <input type="checkbox"/> IX-DVM
Description	Select the sound to be played when placing or receiving a page.
Settings	<ul style="list-style-type: none"> • None • Call Pattern 1 • Call Pattern 2 • Call Pattern 3 • Call Pattern 4 • Call Pattern 5 • Call Pattern 6 • Tremolo Sound • Busy Response Tone • On Hold • Operation Sound (except IX-SOFT) • Error • Pre Tone 1 • Pre Tone 2 • Pre Tone 3 • Communication End Pretone • Call Queue Notification • Waiting Reply Tone • Select a sound that is registered in "Custom Sound Registry (→page 117)". IXG-2C7(-*) is set to "Pre Tone 2" and cannot be changed.

 **Important**

- Configure the paging pretone with a longer duration than the paging pretone of the station receiving the page. Configuring a shorter tone might prevent audio from playing on the other station when paging starts.

■ Auto Answer Tone

Compatible type	<input checked="" type="checkbox"/> IXG-2C7(-*) <input checked="" type="checkbox"/> IXG-MK <input checked="" type="checkbox"/> IX-MV7-* <input checked="" type="checkbox"/> IXG-DM7(-*) <input type="checkbox"/> IX-DA, IX-DB <input type="checkbox"/> IX-BA, IX-BB <input checked="" type="checkbox"/> IX-DV, IX-DVF(-*) <input checked="" type="checkbox"/> IX-SSA(-*) <input checked="" type="checkbox"/> IX-EA, IX-EAU <input type="checkbox"/> IX-FA <input type="checkbox"/> IXGW-LC <input type="checkbox"/> IXGW-(T)GW <input type="checkbox"/> Intercom App <input checked="" type="checkbox"/> IX-SS-2G <input checked="" type="checkbox"/> IX-RS-* <input checked="" type="checkbox"/> IX-SOFT <input type="checkbox"/> IXW-MA <input type="checkbox"/> IX-SPMIC <input type="checkbox"/> VoIP Phone <input checked="" type="checkbox"/> IX-DVM
Description	Select the tone to be played. <ul style="list-style-type: none"> • The incoming tone when an individual call is received. “Auto Answer (→page 132)” must be set to "ON." • The calling tone when an individual call is made. “Auto Answer (→page 132)” must be set to "ON" on the call destination station.
Settings	<ul style="list-style-type: none"> • None • Call Pattern 1 • Call Pattern 2 • Call Pattern 3 • Call Pattern 4 • Call Pattern 5 • Call Pattern 6 • Call Pattern 7 (IX-EA and IX-DVM only) • Tremolo Sound • Busy Response Tone • On Hold • Operation Sound (except IX-SOFT) • Error • Pre Tone 1 • Pre Tone 2 • Pre Tone 3 • Communication End Pretone • Call Queue Notification • Waiting Reply Tone • Select a sound that is registered in “Custom Sound Registry (→page 117)”. IXG-2C7(-*) is set to "Pre Tone 1" and cannot be changed.

■ On Hold

Compatible type	<input checked="" type="checkbox"/> IXG-2C7(-*) <input checked="" type="checkbox"/> IXG-MK <input checked="" type="checkbox"/> IX-MV7-* <input type="checkbox"/> IXG-DM7(-*) <input type="checkbox"/> IX-DA, IX-DB <input type="checkbox"/> IX-BA, IX-BB <input type="checkbox"/> IX-DV, IX-DVF(-*) <input type="checkbox"/> IX-SSA(-*) <input type="checkbox"/> IX-EA, IX-EAU <input type="checkbox"/> IX-FA <input type="checkbox"/> IXGW-LC <input type="checkbox"/> IXGW-(T)GW <input type="checkbox"/> Intercom App <input type="checkbox"/> IX-SS-2G <input type="checkbox"/> IX-RS-* <input checked="" type="checkbox"/> IX-SOFT <input type="checkbox"/> IXW-MA <input type="checkbox"/> IX-SPMIC <input type="checkbox"/> VoIP Phone <input type="checkbox"/> IX-DVM
Description	Select the tone to be played while On-Hold.
Settings	<ul style="list-style-type: none"> • None • Call Pattern 1 • Call Pattern 2 • Call Pattern 3 • Call Pattern 4 • Call Pattern 5 • Call Pattern 6 • Tremolo Sound • Busy Response Tone • On Hold • Operation Sound (except IX-SOFT) • Error • Pre Tone 1 • Pre Tone 2 • Pre Tone 3 • Communication End Pretone • Call Queue Notification • Waiting Reply Tone • Select a sound that is registered in "Custom Sound Registry (→page 117)". IXG-2C7(-*) is set to "On Hold" and cannot be changed.

■ Key Received

Compatible type	<input checked="" type="checkbox"/> IXG-2C7(-*) <input checked="" type="checkbox"/> IXG-MK <input checked="" type="checkbox"/> IX-MV7-* <input checked="" type="checkbox"/> IXG-DM7(-*) <input type="checkbox"/> IX-DA, IX-DB <input type="checkbox"/> IX-BA, IX-BB <input checked="" type="checkbox"/> IX-DV, IX-DVF(-*) <input checked="" type="checkbox"/> IX-SSA(-*) <input checked="" type="checkbox"/> IX-EA, IX-EAU <input type="checkbox"/> IX-FA <input type="checkbox"/> IXGW-LC <input type="checkbox"/> IXGW-(T)GW <input type="checkbox"/> Intercom App <input checked="" type="checkbox"/> IX-SS-2G <input checked="" type="checkbox"/> IX-RS-* <input type="checkbox"/> IX-SOFT <input type="checkbox"/> IXW-MA <input type="checkbox"/> IX-SPMIC <input type="checkbox"/> VoIP Phone <input checked="" type="checkbox"/> IX-DVM
Description	Configure the tone to send to the destination station when the door release key entered using the keypad on the destination station (station performing a door release operation) matches the authentication key of this station (station connected to the electrical lock). The tone will be heard on the destination station.
Settings	<ul style="list-style-type: none"> • None • Call Pattern 1 • Call Pattern 2 • Call Pattern 3 • Call Pattern 4 • Call Pattern 5 • Call Pattern 6 • Call Pattern 7 (IX-EA and IX-DVM only) • Tremolo Sound • Busy Response Tone • On Hold • Operation Sound • Error • Pre Tone 1 • Pre Tone 2 • Pre Tone 3 • Communication End Pretone • Call Queue Notification • Waiting Reply Tone • Select a sound that is registered in "Custom Sound Registry (→page 117)". IXG-2C7(-*) is set to "Operation Sound" and cannot be changed.

■ Error

Compatible type	<input type="checkbox"/> IXG-2C7(-*) <input type="checkbox"/> IXG-MK <input type="checkbox"/> IX-MV7-* <input checked="" type="checkbox"/> IXG-DM7(-*) <input type="checkbox"/> IX-DA, IX-DB <input type="checkbox"/> IX-BA, IX-BB <input checked="" type="checkbox"/> IX-DV, IX-DVF(-*) <input checked="" type="checkbox"/> IX-SSA(-*) <input checked="" type="checkbox"/> IX-EA, IX-EAU <input type="checkbox"/> IX-FA <input type="checkbox"/> IXGW-LC <input type="checkbox"/> IXGW-(T)GW <input type="checkbox"/> Intercom App <input checked="" type="checkbox"/> IX-SS-2G <input checked="" type="checkbox"/> IX-RS-* <input type="checkbox"/> IX-SOFT <input type="checkbox"/> IXW-MA <input type="checkbox"/> IX-SPMIC <input type="checkbox"/> VoIP Phone <input checked="" type="checkbox"/> IX-DVM
Description	Set the tone to be played when an error has occurred, or when keypad or QR door release on IXG-DM7(-*) fails.
Settings	<ul style="list-style-type: none"> • None • Call Pattern 1 • Call Pattern 2 • Call Pattern 3 • Call Pattern 4 • Call Pattern 5 • Call Pattern 6 • Call Pattern 7 (IX-EA and IX-DVM only) • Tremolo Sound • Busy Response Tone • On Hold • Operation Sound • Error • Pre Tone 1 • Pre Tone 2 • Pre Tone 3 • Communication End Pretone • Call Queue Notification • Waiting Reply Tone • Select a sound that is registered in “Custom Sound Registry (→page 117)”.

11.3.3 Mic Select

Description	Not used.
-------------	-----------

11.3.4 Headset Specification

Compatible type	<input type="checkbox"/> IXG-2C7(-*) <input checked="" type="checkbox"/> IXG-MK <input checked="" type="checkbox"/> IX-MV7-* <input type="checkbox"/> IXG-DM7(-*) <input type="checkbox"/> IX-DA, IX-DB <input type="checkbox"/> IX-BA, IX-BB <input type="checkbox"/> IX-DV, IX-DVF(-*) <input type="checkbox"/> IX-SSA(-*) <input type="checkbox"/> IX-EA, IX-EAU <input type="checkbox"/> IX-FA <input type="checkbox"/> IXGW-LC <input type="checkbox"/> IXGW-(T)GW <input type="checkbox"/> Intercom App <input type="checkbox"/> IX-SS-2G <input type="checkbox"/> IX-RS-* <input type="checkbox"/> IX-SOFT <input type="checkbox"/> IXW-MA <input type="checkbox"/> IX-SPMIC <input type="checkbox"/> VoIP Phone <input type="checkbox"/> IX-DVM
Description	Set the device to be connected to the headset jack.
Settings	<ul style="list-style-type: none"> • Mic Device • Headset Device

11.3.5 Audio Output

Compatible type	<input type="checkbox"/> IXG-2C7(-*) <input checked="" type="checkbox"/> IXG-MK <input checked="" type="checkbox"/> IX-MV7-* <input type="checkbox"/> IXG-DM7(-*) <input type="checkbox"/> IX-DA, IX-DB <input type="checkbox"/> IX-BA, IX-BB <input type="checkbox"/> IX-DV, IX-DVF(-*) <input type="checkbox"/> IX-SSA(-*) <input type="checkbox"/> IX-EA, IX-EAU <input type="checkbox"/> IX-FA <input type="checkbox"/> IXGW-LC <input type="checkbox"/> IXGW-(T)GW <input type="checkbox"/> Intercom App <input type="checkbox"/> IX-SS-2G <input type="checkbox"/> IX-RS-* <input type="checkbox"/> IX-SOFT <input type="checkbox"/> IXW-MA <input type="checkbox"/> IX-SPMIC <input type="checkbox"/> VoIP Phone <input type="checkbox"/> IX-DVM
Description	Set using External speaker for Ringtone, Paging Pretone and Paging.
Settings	<ul style="list-style-type: none"> • External speaker output for Ringtone, built-in speaker for Communication • External speaker output for Paging Pretone, built-in speaker for Paging • External speaker output for Ringtone, Paging Pretone and Paging, built-in speaker for Communication



Note

- The tone will play from the speaker of the station even if audio is heard from the external speaker.

11.3.6 Audio Output (for Door)

Compatible type	<input type="checkbox"/> IXG-2C7(-*) <input type="checkbox"/> IXG-MK <input type="checkbox"/> IX-MV7-* <input checked="" type="checkbox"/> IXG-DM7(-*) <input checked="" type="checkbox"/> IX-DA, IX-DB <input checked="" type="checkbox"/> IX-BA, IX-BB <input checked="" type="checkbox"/> IX-DV, IX-DVF(-*) <input checked="" type="checkbox"/> IX-SSA(-*) <input checked="" type="checkbox"/> IX-EA, IX-EAU <input type="checkbox"/> IX-FA <input type="checkbox"/> IXGW-LC <input type="checkbox"/> IXGW-(T)GW <input type="checkbox"/> Intercom App <input type="checkbox"/> IX-SS-2G <input checked="" type="checkbox"/> IX-RS-* <input type="checkbox"/> IX-SOFT <input type="checkbox"/> IXW-MA <input type="checkbox"/> IX-SPMIC <input type="checkbox"/> VoIP Phone <input type="checkbox"/> IX-DVM
Description	Configure how to output the receiving volume during calls, paging pretones, and receiving volume during paging.
Settings	<ul style="list-style-type: none"> • Built-in Speaker for Communication and Paging • Line Audio Output for Communication and Paging (IX-RS-*: External speaker output for Communication and Paging) • Built-in Speaker for Communication, Line Audio Output for paging (IX-RS-*: Built-in Speaker for Communication, External speaker output for Paging)

11.4 Communication

Configure the settings for a call.

Move row

Up to 50 station number rows can be displayed at a time. Switch the screen as follows.

[Previous]: Display the previous 50 rows.

[Next]: Display the next 50 rows.

[Apply]: Enter the station number and click **[Apply]** to move the cursor to the row of the station number that was entered.

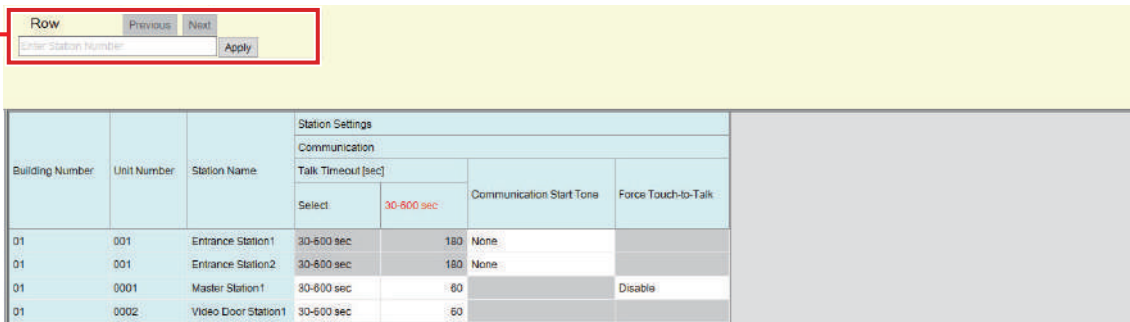

■ Talk Timeout [sec]◆

Compatible type	<input checked="" type="checkbox"/> IXG-2C7(-*) <input type="checkbox"/> IXG-MK <input checked="" type="checkbox"/> IX-MV7-* <input checked="" type="checkbox"/> IXG-DM7(-*) <input checked="" type="checkbox"/> IX-DA, IX-DB <input checked="" type="checkbox"/> IX-BA, IX-BB <input checked="" type="checkbox"/> IX-DV, IX-DVF(-*) <input checked="" type="checkbox"/> IX-SSA(-*) <input checked="" type="checkbox"/> IX-EA, IX-EAU <input type="checkbox"/> IX-FA <input type="checkbox"/> IXGW-LC <input type="checkbox"/> IXGW-(T)GW <input type="checkbox"/> Intercom App <input checked="" type="checkbox"/> IX-SS-2G <input checked="" type="checkbox"/> IX-RS-* <input checked="" type="checkbox"/> IX-SOFT <input type="checkbox"/> IXW-MA <input type="checkbox"/> IX-SPMIC <input type="checkbox"/> VoIP Phone <input checked="" type="checkbox"/> IX-DVM
Description	Set the communication timer when making an outgoing call or answering an incoming page. The call duration during an incoming call will be the call duration set on the destination station.
Settings	<ul style="list-style-type: none"> • Infinite: Do not stop until end operation occurs. • 30-600 sec: Set from 30 to 600 sec (by 1 sec). IXG-2C7(-*) is set to "30-600 sec" and cannot be changed. IXG-DM7(-*) is set to "180 sec" and cannot be changed. For IXG-MK, change the setting on the screen of the station.

! Important

- When on a call with a VoIP phone, this will be the call duration configured on the VoIP phone if the call duration configured on the VoIP phone is shorter than "Talk Timeout [sec]."

■ Communication Start Tone

Compatible type	<input type="checkbox"/> IXG-2C7(-*) <input type="checkbox"/> IXG-MK <input type="checkbox"/> IX-MV7-* <input checked="" type="checkbox"/> IXG-DM7(-*) <input type="checkbox"/> IX-DA, IX-DB <input type="checkbox"/> IX-BA, IX-BB <input checked="" type="checkbox"/> IX-DV, IX-DVF(-*) <input checked="" type="checkbox"/> IX-SSA(-*) <input checked="" type="checkbox"/> IX-EA, IX-EAU <input type="checkbox"/> IX-FA <input type="checkbox"/> IXGW-LC <input type="checkbox"/> IXGW-(T)GW <input type="checkbox"/> Intercom App <input checked="" type="checkbox"/> IX-SS-2G <input checked="" type="checkbox"/> IX-RS-* <input type="checkbox"/> IX-SOFT <input type="checkbox"/> IXW-MA <input type="checkbox"/> IX-SPMIC <input type="checkbox"/> VoIP Phone <input checked="" type="checkbox"/> IX-DVM
Description	Select the tone to be played when communication starts.
Settings	<ul style="list-style-type: none"> • None • Call Pattern 1 • Call Pattern 2 • Call Pattern 3 • Call Pattern 4 • Call Pattern 5 • Call Pattern 6 • Call Pattern 7 (IX-EA and IX-DVM only) • Tremolo Sound • Busy Response Tone • On Hold • Operation Sound • Error • Pre Tone 1 • Pre Tone 2 • Pre Tone 3 • Communication End Pretone • Call Queue Notification • Waiting Reply Tone • Audio Guidance (IXG-DM7(-*) only) • Select a sound that is registered in “Custom Sound Registry (→page 117)”.

■ Force Touch-to-Talk

Compatible type	<input type="checkbox"/> IXG-2C7(-*) <input type="checkbox"/> IXG-MK <input checked="" type="checkbox"/> IX-MV7-* <input type="checkbox"/> IXG-DM7(-*) <input type="checkbox"/> IX-DA, IX-DB <input type="checkbox"/> IX-BA, IX-BB <input type="checkbox"/> IX-DV, IX-DVF(-*) <input type="checkbox"/> IX-SSA(-*) <input type="checkbox"/> IX-EA, IX-EAU <input type="checkbox"/> IX-FA <input type="checkbox"/> IXGW-LC <input type="checkbox"/> IXGW-(T)GW <input type="checkbox"/> Intercom App <input type="checkbox"/> IX-SS-2G <input type="checkbox"/> IX-RS-* <input checked="" type="checkbox"/> IX-SOFT <input type="checkbox"/> IXW-MA <input type="checkbox"/> IX-SPMIC <input type="checkbox"/> VoIP Phone <input type="checkbox"/> IX-DVM
Description	Configure whether to enable touch-to-talk (push-to-talk) when starting communication.
Settings	<ul style="list-style-type: none"> • Enable • Disable <p>For IXG-MK, change the setting on the screen of the station.</p>

11.5 Monitoring

Configure monitoring-related settings.

! Important

- Monitoring cannot be performed for stations other than IXG-DM7(-*), IX-RS-*, outside common area door stations, and door stations in the same unit.

Move row

Up to 50 station number rows can be displayed at a time. Switch the screen as follows.
[Previous]: Display the previous 50 rows.
[Next]: Display the next 50 rows.
[Apply]: Enter the station number and click **[Apply]** to move the cursor to the row of the station number that was entered.

Move Column (Scan Monitoring)

Up to 50 monitoring number columns can be displayed at a time. Switch the screen as follows.
[Previous]: Display the previous 50 columns.
[Next]: Display the next 50 columns.
[Apply]: Enter the monitoring number and click **[Apply]** to display the column of the monitoring number that was entered.

Move to Related Settings

Moves to the selected item within the same Settings screen.

Scan Monitor Number

11.5.1 Monitor Timeout [sec]◆

Compatible type	<input checked="" type="checkbox"/> IXG-2C7(-*) <input checked="" type="checkbox"/> IXG-MK <input checked="" type="checkbox"/> IX-MV7-* <input type="checkbox"/> IXG-DM7(-*) <input type="checkbox"/> IX-DA, IX-DB <input type="checkbox"/> IX-BA, IX-BB <input type="checkbox"/> IX-DV, IX-DVF(-*) <input type="checkbox"/> IX-SSA(-*) <input type="checkbox"/> IX-EA, IX-EAU <input type="checkbox"/> IX-FA <input type="checkbox"/> IXGW-LC <input type="checkbox"/> IXGW-(T)GW <input type="checkbox"/> Intercom App <input type="checkbox"/> IX-SS-2G <input type="checkbox"/> IX-RS-* <input checked="" type="checkbox"/> IX-SOFT <input type="checkbox"/> IXW-MA <input type="checkbox"/> IX-SPMIC <input type="checkbox"/> VoIP Phone <input type="checkbox"/> IX-DVM
Description	Set the monitoring timer by station. Scan Monitor must be end manually.
Settings	<ul style="list-style-type: none"> Infinite: Do not stop until end operation occurs. Monitoring of IX-DA, IX-DB, IX-BA, IX-BB will end in 10 min. 10-600sec: Set 10-600 sec by 1 sec. IXG-2C7(-*) is set to "10-600 sec" and cannot be changed.

💡 Note

- The Intercom App is set to "30 sec" and cannot be changed.

11.5.2 Scan Monitoring

Configure settings to monitor by automatically switching between several stations and network cameras at set intervals. Switching will be performed in registration order.

■ Type

Compatible type	<input type="checkbox"/> IXG-2C7(-*) <input checked="" type="checkbox"/> IXG-MK <input checked="" type="checkbox"/> IX-MV7-* <input type="checkbox"/> IXG-DM7(-*) <input type="checkbox"/> IX-DA, IX-DB <input type="checkbox"/> IX-BA, IX-BB <input type="checkbox"/> IX-DV, IX-DVF(-*) <input type="checkbox"/> IX-SSA(-*) <input type="checkbox"/> IX-EA, IX-EAU <input type="checkbox"/> IX-FA <input type="checkbox"/> IXGW-LC <input type="checkbox"/> IXGW-(T)GW <input type="checkbox"/> Intercom App <input type="checkbox"/> IX-SS-2G <input type="checkbox"/> IX-RS-* <input checked="" type="checkbox"/> IX-SOFT <input type="checkbox"/> IXW-MA <input type="checkbox"/> IX-SPMIC <input type="checkbox"/> VoIP Phone <input type="checkbox"/> IX-DVM
Description	Select the Station Type.
Settings	<ul style="list-style-type: none"> • IX, IXG Station • Network Camera

■ Station Number

Compatible type	<input type="checkbox"/> IXG-2C7(-*) <input checked="" type="checkbox"/> IXG-MK <input checked="" type="checkbox"/> IX-MV7-* <input type="checkbox"/> IXG-DM7(-*) <input type="checkbox"/> IX-DA, IX-DB <input type="checkbox"/> IX-BA, IX-BB <input type="checkbox"/> IX-DV, IX-DVF(-*) <input type="checkbox"/> IX-SSA(-*) <input type="checkbox"/> IX-EA, IX-EAU <input type="checkbox"/> IX-FA <input type="checkbox"/> IXGW-LC <input type="checkbox"/> IXGW-(T)GW <input type="checkbox"/> Intercom App <input type="checkbox"/> IX-SS-2G <input type="checkbox"/> IX-RS-* <input checked="" type="checkbox"/> IX-SOFT <input type="checkbox"/> IXW-MA <input type="checkbox"/> IX-SPMIC <input type="checkbox"/> VoIP Phone <input type="checkbox"/> IX-DVM
Description	Set the Station Number. Enter the Number or click [Select Station] to choose one.
Settings	-

! Important

- Stations in which "IP Address" has not been configured in Administrator mode cannot be configured to be monitored.

■ Camera Settings

Compatible type	<input type="checkbox"/> IXG-2C7(-*) <input checked="" type="checkbox"/> IXG-MK <input checked="" type="checkbox"/> IX-MV7-* <input type="checkbox"/> IXG-DM7(-*) <input type="checkbox"/> IX-DA, IX-DB <input type="checkbox"/> IX-BA, IX-BB <input type="checkbox"/> IX-DV, IX-DVF(-*) <input type="checkbox"/> IX-SSA(-*) <input type="checkbox"/> IX-EA, IX-EAU <input type="checkbox"/> IX-FA <input type="checkbox"/> IXGW-LC <input type="checkbox"/> IXGW-(T)GW <input type="checkbox"/> Intercom App <input type="checkbox"/> IX-SS-2G <input type="checkbox"/> IX-RS-* <input checked="" type="checkbox"/> IX-SOFT <input type="checkbox"/> IXW-MA <input type="checkbox"/> IX-SPMIC <input type="checkbox"/> VoIP Phone <input type="checkbox"/> IX-DVM
Description	Configure the Network Camera to perform monitoring. Enter the number of the network camera set in " Network Camera List (→page 109) " manually or click [Network Camera Selection] to select one.
Settings	Select from the network cameras registered in " Network Camera List (→page 109) ".

■ Dwell Time

Compatible type	<input type="checkbox"/> IXG-2C7(-*) <input checked="" type="checkbox"/> IXG-MK <input checked="" type="checkbox"/> IX-MV7-* <input type="checkbox"/> IXG-DM7(-*) <input type="checkbox"/> IX-DA, IX-DB <input type="checkbox"/> IX-BA, IX-BB <input type="checkbox"/> IX-DV, IX-DVF(-*) <input type="checkbox"/> IX-SSA(-*) <input type="checkbox"/> IX-EA, IX-EAU <input type="checkbox"/> IX-FA <input type="checkbox"/> IXGW-LC <input type="checkbox"/> IXGW-(T)GW <input type="checkbox"/> Intercom App <input type="checkbox"/> IX-SS-2G <input type="checkbox"/> IX-RS-* <input checked="" type="checkbox"/> IX-SOFT <input type="checkbox"/> IXW-MA <input type="checkbox"/> IX-SPMIC <input type="checkbox"/> VoIP Phone <input type="checkbox"/> IX-DVM
Description	Set the dwell time to change destination for scan monitor.
Settings	<ul style="list-style-type: none"> • 5 sec • 10 sec • 30 sec

11.5.3 Prevent Being Monitored

Compatible type	<input type="checkbox"/> IXG-2C7(-*) <input type="checkbox"/> IXG-MK <input type="checkbox"/> IX-MV7-* <input checked="" type="checkbox"/> IXG-DM7(-*) <input type="checkbox"/> IX-DA, IX-DB <input type="checkbox"/> IX-BA, IX-BB <input checked="" type="checkbox"/> IX-DV, IX-DVF(-*) <input checked="" type="checkbox"/> IX-SSA(-*) <input checked="" type="checkbox"/> IX-EA, IX-EAU <input type="checkbox"/> IX-FA <input type="checkbox"/> IXGW-LC <input type="checkbox"/> IXGW-(T)GW <input type="checkbox"/> Intercom App <input checked="" type="checkbox"/> IX-SS-2G <input checked="" type="checkbox"/> IX-RS-* <input type="checkbox"/> IX-SOFT <input type="checkbox"/> IXW-MA <input type="checkbox"/> IX-SPMIC <input type="checkbox"/> VoIP Phone <input checked="" type="checkbox"/> IX-DVM
Description	Select Enable / Disable to prevent being monitored.
Settings	<ul style="list-style-type: none"> • Enable • Disable

11.5.4 Monitoring Notification Tone

Compatible type	<input type="checkbox"/> IXG-2C7(-*) <input type="checkbox"/> IXG-MK <input type="checkbox"/> IX-MV7-* <input checked="" type="checkbox"/> IXG-DM7(-*) <input type="checkbox"/> IX-DA, IX-DB <input type="checkbox"/> IX-BA, IX-BB <input checked="" type="checkbox"/> IX-DV, IX-DVF(-*) <input checked="" type="checkbox"/> IX-SSA(-*) <input checked="" type="checkbox"/> IX-EA, IX-EAU <input type="checkbox"/> IX-FA <input type="checkbox"/> IXGW-LC <input type="checkbox"/> IXGW-(T)GW <input type="checkbox"/> Intercom App <input checked="" type="checkbox"/> IX-SS-2G <input checked="" type="checkbox"/> IX-RS-* <input type="checkbox"/> IX-SOFT <input type="checkbox"/> IXW-MA <input type="checkbox"/> IX-SPMIC <input type="checkbox"/> VoIP Phone <input checked="" type="checkbox"/> IX-DVM
Description	Select the tone to be played when monitored by another station.
Settings	<ul style="list-style-type: none"> • None • Call Pattern 1 • Call Pattern 2 • Call Pattern 3 • Call Pattern 4 • Call Pattern 5 • Call Pattern 6 • Call Pattern 7 (IX-EA and IX-DVM only) • Tremolo Sound • Busy Response Tone • On Hold • Operation Sound • Error • Pre Tone 1 • Pre Tone 2 • Pre Tone 3 • Communication End Pretone • Call Queue Notification • Waiting Reply Tone • Select a sound that is registered in "Custom Sound Registry (→page 117)".

11.5.5 Monitored LED Notification

Compatible type	<input type="checkbox"/> IXG-2C7(-*) <input type="checkbox"/> IXG-MK <input type="checkbox"/> IX-MV7-* <input checked="" type="checkbox"/> IXG-DM7(-*) <input type="checkbox"/> IX-DA, IX-DB <input type="checkbox"/> IX-BA, IX-BB <input checked="" type="checkbox"/> IX-DV, IX-DVF(-*) <input checked="" type="checkbox"/> IX-SSA(-*) <input checked="" type="checkbox"/> IX-EA, IX-EAU <input type="checkbox"/> IX-FA <input type="checkbox"/> IXGW-LC <input type="checkbox"/> IXGW-(T)GW <input type="checkbox"/> Intercom App <input checked="" type="checkbox"/> IX-SS-2G <input checked="" type="checkbox"/> IX-RS-* <input type="checkbox"/> IX-SOFT <input type="checkbox"/> IXW-MA <input type="checkbox"/> IX-SPMIC <input type="checkbox"/> VoIP Phone <input checked="" type="checkbox"/> IX-DVM
Description	Select Enable / Disable for status LED notification (Blue flashing) while being monitored by another station.
Settings	<ul style="list-style-type: none"> • Enable • Disable <p>IXG-DM7(-*) is set to "Disable" and cannot be changed.</p>

11.6 Master Station Display

Configure screen display-related settings.

Move row

Up to 50 station number rows can be displayed at a time. Switch the screen as follows.

[Previous]: Display the previous 50 rows.

[Next]: Display the next 50 rows.

[Apply]: Enter the station number and click **[Apply]** to move the cursor to the row of the station number that was entered.

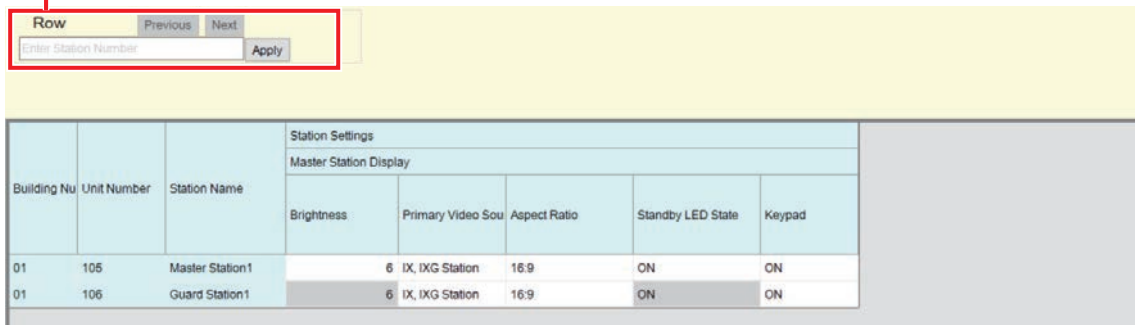

■ Brightness

Compatible type	<input type="checkbox"/> IXG-2C7(-*) <input checked="" type="checkbox"/> IXG-MK <input checked="" type="checkbox"/> IX-MV7-* <input type="checkbox"/> IXG-DM7(-*) <input type="checkbox"/> IX-DA, IX-DB <input type="checkbox"/> IX-BA, IX-BB <input type="checkbox"/> IX-DV, IX-DVF(-*) <input type="checkbox"/> IX-SSA(-*) <input type="checkbox"/> IX-EA, IX-EAU <input type="checkbox"/> IX-FA <input type="checkbox"/> IXGW-LC <input type="checkbox"/> IXGW-(T)GW <input type="checkbox"/> Intercom App <input type="checkbox"/> IX-SS-2G <input type="checkbox"/> IX-RS-* <input type="checkbox"/> IX-SOFT <input type="checkbox"/> IXW-MA <input type="checkbox"/> IX-SPMIC <input type="checkbox"/> VoIP Phone <input type="checkbox"/> IX-DVM
Description	Set the brightness of master station display.
Settings	1 (dark) to 10 (bright) For IXG-MK, change the setting on the screen of the station.

■ Primary Video Source

Compatible type	<input type="checkbox"/> IXG-2C7(-*) <input checked="" type="checkbox"/> IXG-MK <input checked="" type="checkbox"/> IX-MV7-* <input type="checkbox"/> IXG-DM7(-*) <input type="checkbox"/> IX-DA, IX-DB <input type="checkbox"/> IX-BA, IX-BB <input type="checkbox"/> IX-DV, IX-DVF(-*) <input type="checkbox"/> IX-SSA(-*) <input type="checkbox"/> IX-EA, IX-EAU <input type="checkbox"/> IX-FA <input type="checkbox"/> IXGW-LC <input type="checkbox"/> IXGW-(T)GW <input type="checkbox"/> Intercom App <input type="checkbox"/> IX-SS-2G <input type="checkbox"/> IX-RS-* <input checked="" type="checkbox"/> IX-SOFT <input type="checkbox"/> IXW-MA <input type="checkbox"/> IX-SPMIC <input type="checkbox"/> VoIP Phone <input type="checkbox"/> IX-DVM
Description	Select the primary video source when showing 2 video streams simultaneously.
Settings	<ul style="list-style-type: none"> IX, IXC Station Network Camera

■ Aspect Ratio

Compatible type	<input type="checkbox"/> IXG-2C7(-*) <input checked="" type="checkbox"/> IXG-MK <input checked="" type="checkbox"/> IX-MV7-* <input type="checkbox"/> IXG-DM7(-*) <input type="checkbox"/> IX-DA, IX-DB <input type="checkbox"/> IX-BA, IX-BB <input type="checkbox"/> IX-DV, IX-DVF(-*) <input type="checkbox"/> IX-SSA(-*) <input type="checkbox"/> IX-EA, IX-EAU <input type="checkbox"/> IX-FA <input type="checkbox"/> IXGW-LC <input type="checkbox"/> IXGW-(T)GW <input type="checkbox"/> Intercom App <input type="checkbox"/> IX-SS-2G <input type="checkbox"/> IX-RS-* <input type="checkbox"/> IX-SOFT <input type="checkbox"/> IXW-MA <input type="checkbox"/> IX-SPMIC <input type="checkbox"/> VoIP Phone <input type="checkbox"/> IX-DVM
Description	Select the video aspect for primary video source.
Settings	<ul style="list-style-type: none"> 16:9 4:3

■ Standby LED State

Compatible type	<input type="checkbox"/> IXG-2C7(-*) <input checked="" type="checkbox"/> IXG-MK <input checked="" type="checkbox"/> IX-MV7-* <input type="checkbox"/> IXG-DM7(-*) <input type="checkbox"/> IX-DA, IX-DB <input type="checkbox"/> IX-BA, IX-BB <input type="checkbox"/> IX-DV, IX-DVF(-*) <input type="checkbox"/> IX-SSA(-*) <input type="checkbox"/> IX-EA, IX-EAU <input type="checkbox"/> IX-FA <input type="checkbox"/> IXGW-LC <input type="checkbox"/> IXGW-(T)GW <input type="checkbox"/> Intercom App <input type="checkbox"/> IX-SS-2G <input type="checkbox"/> IX-RS-* <input type="checkbox"/> IX-SOFT <input type="checkbox"/> IXW-MA <input type="checkbox"/> IX-SPMIC <input type="checkbox"/> VoIP Phone <input type="checkbox"/> IX-DVM
Description	Select ON / OFF for standby status LED.
Settings	<ul style="list-style-type: none"> • ON • OFF For IXG-MK, change the setting on the screen of the station.

■ Keypad

Compatible type	<input type="checkbox"/> IXG-2C7(-*) <input checked="" type="checkbox"/> IXG-MK <input checked="" type="checkbox"/> IX-MV7-* <input type="checkbox"/> IXG-DM7(-*) <input type="checkbox"/> IX-DA, IX-DB <input type="checkbox"/> IX-BA, IX-BB <input type="checkbox"/> IX-DV, IX-DVF(-*) <input type="checkbox"/> IX-SSA(-*) <input type="checkbox"/> IX-EA, IX-EAU <input type="checkbox"/> IX-FA <input type="checkbox"/> IXGW-LC <input type="checkbox"/> IXGW-(T)GW <input type="checkbox"/> Intercom App <input type="checkbox"/> IX-SS-2G <input type="checkbox"/> IX-RS-* <input checked="" type="checkbox"/> IX-SOFT <input type="checkbox"/> IXW-MA <input type="checkbox"/> IX-SPMIC <input type="checkbox"/> VoIP Phone <input type="checkbox"/> IX-DVM
Description	Select ON / OFF for display Keypad to use for door release or playing location message.
Settings	<ul style="list-style-type: none"> • ON • OFF

11.7 Camera

Configure camera settings.

Move row

Up to 50 station number rows can be displayed at a time. Switch the screen as follows.

[Previous]: Display the previous 50 rows.

[Next]: Display the next 50 rows.

[Apply]: Enter the station number and click **[Apply]** to move the cursor to the row of the station number that was entered.

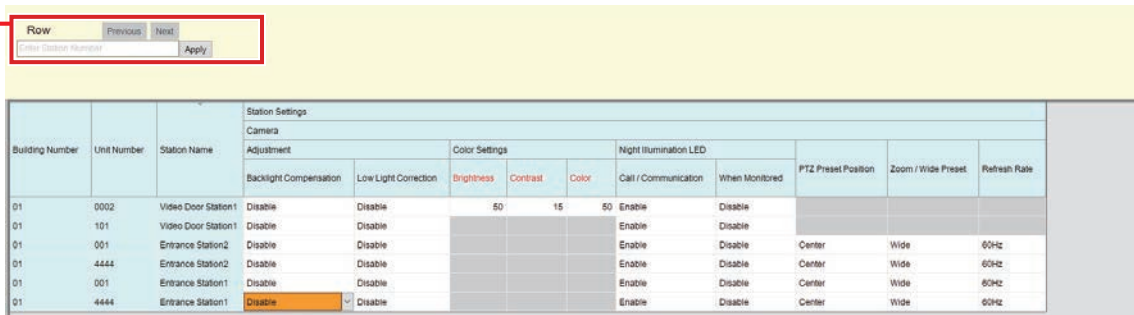

11.7.1 Adjustment

■ Backlight Compensation

Compatible type	<input type="checkbox"/> IXG-2C7(-*) <input type="checkbox"/> IXG-MK <input type="checkbox"/> IX-MV7-* <input checked="" type="checkbox"/> IXG-DM7(-*) <input checked="" type="checkbox"/> IX-DA, IX-DB <input type="checkbox"/> IX-BA, IX-BB <input checked="" type="checkbox"/> IX-DV, IX-DVF(-*) <input type="checkbox"/> IX-SSA(-*) <input checked="" type="checkbox"/> IX-EA, IX-EAU <input type="checkbox"/> IX-FA <input type="checkbox"/> IXGW-LC <input type="checkbox"/> IXGW-(T)GW <input type="checkbox"/> Intercom App <input type="checkbox"/> IX-SS-2G <input type="checkbox"/> IX-RS-* <input type="checkbox"/> IX-SOFT <input type="checkbox"/> IXW-MA <input type="checkbox"/> IX-SPMIC <input type="checkbox"/> VoIP Phone <input checked="" type="checkbox"/> IX-DVM
Description	During an outgoing call or monitoring, video with backlight compensation adjustment will be sent to the destination station. The adjustment can be removed through operation by the destination station.
Settings	<ul style="list-style-type: none"> • Enable • Disable

■ Low Light Correction

Compatible type	<input type="checkbox"/> IXG-2C7(-*) <input type="checkbox"/> IXG-MK <input type="checkbox"/> IX-MV7-* <input checked="" type="checkbox"/> IXG-DM7(-*) <input checked="" type="checkbox"/> IX-DA, IX-DB <input type="checkbox"/> IX-BA, IX-BB <input checked="" type="checkbox"/> IX-DV, IX-DVF(-*) <input type="checkbox"/> IX-SSA(-*) <input checked="" type="checkbox"/> IX-EA, IX-EAU <input type="checkbox"/> IX-FA <input type="checkbox"/> IXGW-LC <input type="checkbox"/> IXGW-(T)GW <input type="checkbox"/> Intercom App <input type="checkbox"/> IX-SS-2G <input type="checkbox"/> IX-RS-* <input type="checkbox"/> IX-SOFT <input type="checkbox"/> IXW-MA <input type="checkbox"/> IX-SPMIC <input type="checkbox"/> VoIP Phone <input checked="" type="checkbox"/> IX-DVM
Description	Send an video on which low light sensitivity has been performed to the destination station, when dark video is captured at night, etc. when a call is made or when being monitored. The adjustment can be removed through operation by the destination station.
Settings	<ul style="list-style-type: none"> • Enable • Disable

11.7.2 Color Settings

Important

- Settings will not be applied if changed while video is displayed. Stop and then start video to confirm.

■ Brightness◆

Compatible type	<input type="checkbox"/> IXG-2C7(-*) <input type="checkbox"/> IXG-MK <input type="checkbox"/> IX-MV7-* <input type="checkbox"/> IXG-DM7(-*) <input checked="" type="checkbox"/> IX-DA, IX-DB <input type="checkbox"/> IX-BA, IX-BB <input type="checkbox"/> IX-DV, IX-DVF(-*) <input type="checkbox"/> IX-SSA(-*) <input type="checkbox"/> IX-EA, IX-EAU <input type="checkbox"/> IX-FA <input type="checkbox"/> IXGW-LC <input type="checkbox"/> IXGW-(T)GW <input type="checkbox"/> Intercom App <input type="checkbox"/> IX-SS-2G <input type="checkbox"/> IX-RS-* <input type="checkbox"/> IX-SOFT <input type="checkbox"/> IXW-MA <input type="checkbox"/> IX-SPMIC <input type="checkbox"/> VoIP Phone <input type="checkbox"/> IX-DVM
Description	Set the Brightness for camera setting.
Settings	1 (dark) to 100 (bright)

■ Contrast◆

Compatible type	<input type="checkbox"/> IXG-2C7(-*) <input type="checkbox"/> IXG-MK <input type="checkbox"/> IX-MV7-* <input type="checkbox"/> IXG-DM7(-*) <input checked="" type="checkbox"/> IX-DA, IX-DB <input type="checkbox"/> IX-BA, IX-BB <input type="checkbox"/> IX-DV, IX-DVF(-*) <input type="checkbox"/> IX-SSA(-*) <input type="checkbox"/> IX-EA, IX-EAU <input type="checkbox"/> IX-FA <input type="checkbox"/> IXGW-LC <input type="checkbox"/> IXGW-(T)GW <input type="checkbox"/> Intercom App <input type="checkbox"/> IX-SS-2G <input type="checkbox"/> IX-RS-* <input type="checkbox"/> IX-SOFT <input type="checkbox"/> IXW-MA <input type="checkbox"/> IX-SPMIC <input type="checkbox"/> VoIP Phone <input type="checkbox"/> IX-DVM
Description	Set the Contrast for camera setting.
Settings	1 (Weak) - 100 (Strong)

■ Color◆

Compatible type	<input type="checkbox"/> IXG-2C7(-*) <input type="checkbox"/> IXG-MK <input type="checkbox"/> IX-MV7-* <input type="checkbox"/> IXG-DM7(-*) <input checked="" type="checkbox"/> IX-DA, IX-DB <input type="checkbox"/> IX-BA, IX-BB <input type="checkbox"/> IX-DV, IX-DVF(-*) <input type="checkbox"/> IX-SSA(-*) <input type="checkbox"/> IX-EA, IX-EAU <input type="checkbox"/> IX-FA <input type="checkbox"/> IXGW-LC <input type="checkbox"/> IXGW-(T)GW <input type="checkbox"/> Intercom App <input type="checkbox"/> IX-SS-2G <input type="checkbox"/> IX-RS-* <input type="checkbox"/> IX-SOFT <input type="checkbox"/> IXW-MA <input type="checkbox"/> IX-SPMIC <input type="checkbox"/> VoIP Phone <input type="checkbox"/> IX-DVM
Description	Set the Color for camera setting.
Settings	1 (weak) to 100 (strong)

11.7.3 Night Illumination LED

■ Call / Communication

Compatible type	<input type="checkbox"/> IXG-2C7(-*) <input type="checkbox"/> IXG-MK <input type="checkbox"/> IX-MV7-* <input checked="" type="checkbox"/> IXG-DM7(-*) <input checked="" type="checkbox"/> IX-DA, IX-DB <input type="checkbox"/> IX-BA, IX-BB <input checked="" type="checkbox"/> IX-DV, IX-DVF(-*) <input type="checkbox"/> IX-SSA(-*) <input checked="" type="checkbox"/> IX-EA, IX-EAU <input type="checkbox"/> IX-FA <input type="checkbox"/> IXGW-LC <input type="checkbox"/> IXGW-(T)GW <input type="checkbox"/> Intercom App <input type="checkbox"/> IX-SS-2G <input type="checkbox"/> IX-RS-* <input type="checkbox"/> IX-SOFT <input type="checkbox"/> IXW-MA <input type="checkbox"/> IX-SPMIC <input type="checkbox"/> VoIP Phone <input checked="" type="checkbox"/> IX-DVM
Description	Select Enable / Disable for white LED while calling or communicating in low light situation.
Settings	<ul style="list-style-type: none"> • Enable • Disable

■ When Monitored

Compatible type	<input type="checkbox"/> IXG-2C7(-*) <input type="checkbox"/> IXG-MK <input type="checkbox"/> IX-MV7-* <input checked="" type="checkbox"/> IXG-DM7(-*) <input checked="" type="checkbox"/> IX-DA, IX-DB <input type="checkbox"/> IX-BA, IX-BB <input checked="" type="checkbox"/> IX-DV, IX-DVF(-*) <input type="checkbox"/> IX-SSA(-*) <input checked="" type="checkbox"/> IX-EA, IX-EAU <input type="checkbox"/> IX-FA <input type="checkbox"/> IXGW-LC <input type="checkbox"/> IXGW-(T)GW <input type="checkbox"/> Intercom App <input type="checkbox"/> IX-SS-2G <input type="checkbox"/> IX-RS-* <input type="checkbox"/> IX-SOFT <input type="checkbox"/> IXW-MA <input type="checkbox"/> IX-SPMIC <input type="checkbox"/> VoIP Phone <input checked="" type="checkbox"/> IX-DVM
Description	Select Enable / Disable for white LED while being monitored in low light situation.
Settings	<ul style="list-style-type: none"> • Enable • Disable

11.7.4 PTZ Preset Position

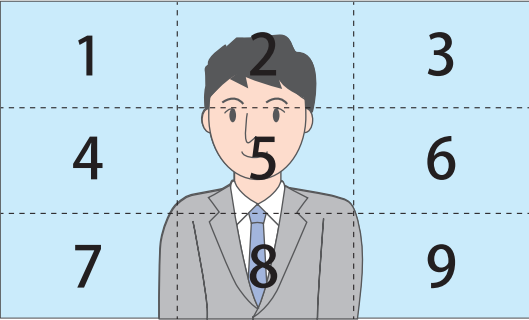
Compatible type	<input type="checkbox"/> IXG-2C7(-*) <input type="checkbox"/> IXG-MK <input type="checkbox"/> IX-MV7-* <input checked="" type="checkbox"/> IXG-DM7(-*) <input type="checkbox"/> IX-DA, IX-DB <input type="checkbox"/> IX-BA, IX-BB <input type="checkbox"/> IX-DV, IX-DVF(-*) <input type="checkbox"/> IX-SSA(-*) <input type="checkbox"/> IX-EA, IX-EAU <input type="checkbox"/> IX-FA <input type="checkbox"/> IXGW-LC <input type="checkbox"/> IXGW-(T)GW <input type="checkbox"/> Intercom App <input type="checkbox"/> IX-SS-2G <input type="checkbox"/> IX-RS-* <input type="checkbox"/> IX-SOFT <input type="checkbox"/> IXW-MA <input type="checkbox"/> IX-SPMIC <input type="checkbox"/> VoIP Phone <input type="checkbox"/> IX-DVM
Description	If " Zoom / Wide Preset (→page 267) " is set to "Zoom," configure the zoom position of the video sent to the destination station when an outgoing call is made.
Settings	Top Left(1), Up(2), Top Right(3), Left(4), Center(5), Right(6), Bottom Left(7), Down(8), Bottom Right(9) <div style="text-align: center; margin-top: 10px;">  </div>

11.7.5 Zoom / Wide Preset

Compatible type	<input type="checkbox"/> IXG-2C7(-*) <input type="checkbox"/> IXG-MK <input type="checkbox"/> IX-MV7-* <input checked="" type="checkbox"/> IXG-DM7(-*) <input type="checkbox"/> IX-DA, IX-DB <input type="checkbox"/> IX-BA, IX-BB <input type="checkbox"/> IX-DV, IX-DVF(-*) <input type="checkbox"/> IX-SSA(-*) <input type="checkbox"/> IX-EA, IX-EAU <input type="checkbox"/> IX-FA <input type="checkbox"/> IXGW-LC <input type="checkbox"/> IXGW-(T)GW <input type="checkbox"/> Intercom App <input type="checkbox"/> IX-SS-2G <input type="checkbox"/> IX-RS-* <input type="checkbox"/> IX-SOFT <input type="checkbox"/> IXW-MA <input type="checkbox"/> IX-SPMIC <input type="checkbox"/> VoIP Phone <input type="checkbox"/> IX-DVM
Description	Configure whether to send zoomed video or wide video to the destination station when an outgoing call is made. If set to "Zoom," a video of the area set in "PTZ Preset Position (→page 266)" will be sent.
Settings	<ul style="list-style-type: none"> • Zoom • Wide

11.7.6 Refresh Rate

Compatible type	<input type="checkbox"/> IXG-2C7(-*) <input type="checkbox"/> IXG-MK <input type="checkbox"/> IX-MV7-* <input checked="" type="checkbox"/> IXG-DM7(-*) <input type="checkbox"/> IX-DA, IX-DB <input type="checkbox"/> IX-BA, IX-BB <input type="checkbox"/> IX-DV, IX-DVF(-*) <input type="checkbox"/> IX-SSA(-*) <input type="checkbox"/> IX-EA, IX-EAU <input type="checkbox"/> IX-FA <input type="checkbox"/> IXGW-LC <input type="checkbox"/> IXGW-(T)GW <input type="checkbox"/> Intercom App <input type="checkbox"/> IX-SS-2G <input type="checkbox"/> IX-RS-* <input type="checkbox"/> IX-SOFT <input type="checkbox"/> IXW-MA <input type="checkbox"/> IX-SPMIC <input type="checkbox"/> VoIP Phone <input type="checkbox"/> IX-DVM
Description	Select the refresh rate of the Entrance Station camera.
Settings	<ul style="list-style-type: none"> • 50Hz • 60Hz

11.8 Line Supervision

Configure settings related to line supervision and device checking performed by IX-MV7-* and IX-SOFT. Monitor a station other than a VoIP phone registered in [“Station List \(→page 104\)”](#).

Move row

Up to 50 station number rows can be displayed at a time. Switch the screen as follows.

[Previous]: Display the previous 50 rows.

[Next]: Display the next 50 rows.

[Apply]: Enter the station number and click **[Apply]** to move the cursor to the row of the station number that was entered.

Row Previous Next
 Apply

Building Nu	Unit Number	Station Name	Station Settings							
			Line Supervision							
			Line Supervision Interval				Device Check Interval			
			Test Interval	Weekly	Line Supervision Schedule		Test Interval	Weekly	Device Check Schedule	
		Hour	Minute			Hour	Minute			
01	0001	Master Station1	OFF	Sun	00	00	OFF	Sun	00	00
02	0002	Master Station1	OFF	Sun	00	00	OFF	Sun	00	00

11.8.1 Line Supervision Interval

■ Test Interval

Compatible type	<input type="checkbox"/> IXG-2C7(-*) <input type="checkbox"/> IXG-MK <input checked="" type="checkbox"/> IX-MV7-* <input type="checkbox"/> IXG-DM7(-*) <input type="checkbox"/> IX-DA, IX-DB <input type="checkbox"/> IX-BA, IX-BB <input type="checkbox"/> IX-DV, IX-DVF(-*) <input type="checkbox"/> IX-SSA(-*) <input type="checkbox"/> IX-EA, IX-EAU <input type="checkbox"/> IX-FA <input type="checkbox"/> IXGW-LC <input type="checkbox"/> IXGW-(T)GW <input type="checkbox"/> Intercom App <input type="checkbox"/> IX-SS-2G <input type="checkbox"/> IX-RS-* <input checked="" type="checkbox"/> IX-SOFT <input type="checkbox"/> IXW-MA <input type="checkbox"/> IX-SPMIC <input type="checkbox"/> VoIP Phone <input type="checkbox"/> IX-DVM
Description	Set the Line Supervision test interval.
Settings	<ul style="list-style-type: none"> • OFF • 15 sec • 20 min • 30 min • 60 min • 1 day • Weekly

■ Weekly

Compatible type	<input type="checkbox"/> IXG-2C7(-*) <input type="checkbox"/> IXG-MK <input checked="" type="checkbox"/> IX-MV7-* <input type="checkbox"/> IXG-DM7(-*) <input type="checkbox"/> IX-DA, IX-DB <input type="checkbox"/> IX-BA, IX-BB <input type="checkbox"/> IX-DV, IX-DVF(-*) <input type="checkbox"/> IX-SSA(-*) <input type="checkbox"/> IX-EA, IX-EAU <input type="checkbox"/> IX-FA <input type="checkbox"/> IXGW-LC <input type="checkbox"/> IXGW-(T)GW <input type="checkbox"/> Intercom App <input type="checkbox"/> IX-SS-2G <input type="checkbox"/> IX-RS-* <input checked="" type="checkbox"/> IX-SOFT <input type="checkbox"/> IXW-MA <input type="checkbox"/> IX-SPMIC <input type="checkbox"/> VoIP Phone <input type="checkbox"/> IX-DVM
Description	If "Test Interval" was set to "Weekly," set the day of the week to perform line supervision.
Settings	Sun-Sat

■ Line Supervision Schedule

Compatible type	<input type="checkbox"/> IXG-2C7(-*) <input type="checkbox"/> IXG-MK <input checked="" type="checkbox"/> IX-MV7-* <input type="checkbox"/> IXG-DM7(-*) <input type="checkbox"/> IX-DA, IX-DB <input type="checkbox"/> IX-BA, IX-BB <input type="checkbox"/> IX-DV, IX-DVF(-*) <input type="checkbox"/> IX-SSA(-*) <input type="checkbox"/> IX-EA, IX-EAU <input type="checkbox"/> IX-FA <input type="checkbox"/> IXGW-LC <input type="checkbox"/> IXGW-(T)GW <input type="checkbox"/> Intercom App <input type="checkbox"/> IX-SS-2G <input type="checkbox"/> IX-RS-* <input checked="" type="checkbox"/> IX-SOFT <input type="checkbox"/> IXW-MA <input type="checkbox"/> IX-SPMIC <input type="checkbox"/> VoIP Phone <input type="checkbox"/> IX-DVM
Description	Set the time when automatic line monitoring starts. Configure this if "1 day" or "Weekly" was selected in "Test Interval."
Settings	00:00-23:59

11.8.2 Device Check Interval

■ Test Interval

Compatible type	<input type="checkbox"/> IXG-2C7(-*) <input type="checkbox"/> IXG-MK <input checked="" type="checkbox"/> IX-MV7-* <input type="checkbox"/> IXG-DM7(-*) <input type="checkbox"/> IX-DA, IX-DB <input type="checkbox"/> IX-BA, IX-BB <input type="checkbox"/> IX-DV, IX-DVF(-*) <input type="checkbox"/> IX-SSA(-*) <input type="checkbox"/> IX-EA, IX-EAU <input type="checkbox"/> IX-FA <input type="checkbox"/> IXGW-LC <input type="checkbox"/> IXGW-(T)GW <input type="checkbox"/> Intercom App <input type="checkbox"/> IX-SS-2G <input type="checkbox"/> IX-RS-* <input checked="" type="checkbox"/> IX-SOFT <input type="checkbox"/> IXW-MA <input type="checkbox"/> IX-SPMIC <input type="checkbox"/> VoIP Phone <input type="checkbox"/> IX-DVM
Description	Set the Device Check test interval.
Settings	<ul style="list-style-type: none"> • OFF • 10 min • 20 min • 30 min • 60 min • 1 day • Weekly

■ Weekly

Compatible type	<input type="checkbox"/> IXG-2C7(-*) <input type="checkbox"/> IXG-MK <input checked="" type="checkbox"/> IX-MV7-* <input type="checkbox"/> IXG-DM7(-*) <input type="checkbox"/> IX-DA, IX-DB <input type="checkbox"/> IX-BA, IX-BB <input type="checkbox"/> IX-DV, IX-DVF(-*) <input type="checkbox"/> IX-SSA(-*) <input type="checkbox"/> IX-EA, IX-EAU <input type="checkbox"/> IX-FA <input type="checkbox"/> IXGW-LC <input type="checkbox"/> IXGW-(T)GW <input type="checkbox"/> Intercom App <input type="checkbox"/> IX-SS-2G <input type="checkbox"/> IX-RS-* <input checked="" type="checkbox"/> IX-SOFT <input type="checkbox"/> IXW-MA <input type="checkbox"/> IX-SPMIC <input type="checkbox"/> VoIP Phone <input type="checkbox"/> IX-DVM
Description	If "Test Interval" was set to "Weekly," set the day of the week to perform device checking.
Settings	Sun-Sat

■ Device Check Schedule

Compatible type	<input type="checkbox"/> IXG-2C7(-*) <input type="checkbox"/> IXG-MK <input checked="" type="checkbox"/> IX-MV7-* <input type="checkbox"/> IXG-DM7(-*) <input type="checkbox"/> IX-DA, IX-DB <input type="checkbox"/> IX-BA, IX-BB <input type="checkbox"/> IX-DV, IX-DVF(-*) <input type="checkbox"/> IX-SSA(-*) <input type="checkbox"/> IX-EA, IX-EAU <input type="checkbox"/> IX-FA <input type="checkbox"/> IXGW-LC <input type="checkbox"/> IXGW-(T)GW <input type="checkbox"/> Intercom App <input type="checkbox"/> IX-SS-2G <input type="checkbox"/> IX-RS-* <input checked="" type="checkbox"/> IX-SOFT <input type="checkbox"/> IXW-MA <input type="checkbox"/> IX-SPMIC <input type="checkbox"/> VoIP Phone <input type="checkbox"/> IX-DVM
Description	Set the time when automatic failure monitoring starts. Configure this if "1 day" or "Weekly" was selected in "Test Interval."
Settings	00:00-23:59

11.9 Mobile App and Phone Usage

■ Mobile App and Phone Usage Notification

Compatible type	<input checked="" type="checkbox"/> IXG-2C7(-*) <input type="checkbox"/> IXG-MK <input type="checkbox"/> IX-MV7-* <input type="checkbox"/> IXG-DM7(-*) <input type="checkbox"/> IX-DA, IX-DB <input type="checkbox"/> IX-BA, IX-BB <input type="checkbox"/> IX-DV, IX-DVF(-*) <input type="checkbox"/> IX-SSA(-*) <input type="checkbox"/> IX-EA, IX-EAU <input type="checkbox"/> IX-FA <input type="checkbox"/> IXGW-LC <input type="checkbox"/> IXGW-(T)GW <input type="checkbox"/> Intercom App <input type="checkbox"/> IX-SS-2G <input type="checkbox"/> IX-RS-* <input type="checkbox"/> IX-SOFT <input type="checkbox"/> IXW-MA <input type="checkbox"/> IX-SPMIC <input type="checkbox"/> VoIP Phone <input type="checkbox"/> IX-DVM
Description	Configure the frequency to notify IXG-2C7(-*) of the connection status of the Intercom App or phone.
Settings	<ul style="list-style-type: none"> • Do not Notify • Every Month • Every 2 months • Every 3 months

12. Maintenance (Advanced Settings)

12.1 Firmware Update

Access our website at "<https://www.aiphone.net/>" to download the latest version of the firmware.

! Important

- To update the firmware, "Association Settings" must have been performed on the station to update in Administrator mode, and the PC must be able to communicate with the system.
- If the firmware update is started while the station is operating (such as on a call), the operation will end and the firmware update will begin.
- If station power is turned off while updating the firmware, the station may malfunction.
- The station will be inoperable while updating the firmware.
- When the firmware is updated, the station will be automatically restarted.
- The Gateway Adaptor firmware is automatically updated on the cloud server side at regular intervals.
- The Intercom App is not available for use while the Gateway Adaptor firmware is being updated.

Update Firmware

Download the log file before updating IXG-2C7(-*), IXG-DM7(-*), and IXGW-(T)GW with version 1.02 or older. To download the log file, go to "Connection -> Download Log File".

To check the current firmware version, go to "Connection -> Station Search".

Select Firmware files:

IXG-2C7(-*)		Browse
IXG-DM7(-*)(Main)		Browse
IXG-DM7(-*)(Sub)		Browse
IXG-MK		Browse
IXGW-(T)GW		Browse
IXGW-LC		Browse
IX-MV7-*		Browse
IX-DV,IX-DVF(-*)		Browse
IX-DVM		Browse
IX-SSA(-*)		Browse
IX-EA,IX-EAU		Browse
IX-FA		Browse

Select Station(s) to update:

Station List					
Select	Building Nu	Unit Number	Station Name	Station Type	Status
<input checked="" type="checkbox"/>	01	001	Entrance Station 1 (Main)	IXG-DM7(-*)	-
<input type="checkbox"/>	01	001	Entrance Station 1 (Sub)	IXG-DM7(-*)	-
<input type="checkbox"/>	01	001	Entrance Station 2 (Main)	IXG-DM7(-*)	-
<input type="checkbox"/>	01	001	Entrance Station 2 (Sub)	IXG-DM7(-*)	-
<input type="checkbox"/>	01	0001	Master Station 1	IX-MV7-*	-

Select Station by Type: All Select Unselect

Update

How to update the firmware

1. Click **[Browse]** and select the firmware file for each station.
2. Select the station for which to update the firmware from "Station List." (Multiple selections allowed.)
 - To select or unselect stations in a batch, choose the station type and click **[Select]** or **[Unselect]**.
 - Stations in which "Association Settings" has not been performed in Administrator mode cannot be selected.
3. Click **[Update]**.
 - The firmware update may take approximately 10 minutes per station.
4. Click **[OK]**.
 - Click **[Cancel]** to return to the "Update Firmware" screen without updating.

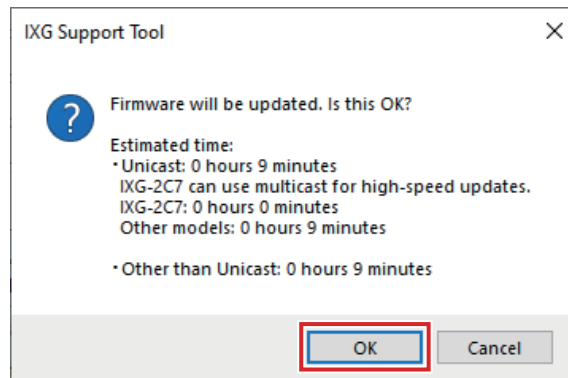

5. Click **[OK]**.
 - The result is displayed in "Station List" - "Status."
 - In Process: The firmware is being updated.
 - Success: Update successful.
 - Failed: Update failed. Try updating again.



Additional Settings



1. Confirming Station Information

1.1 Confirming Station Information on the Entrance Station

Confirm the following information on the Entrance Station.

- Main: The firmware version for the main CPU
- Sub: The firmware version for the sub CPU, which controls card reader and access controller linking (IXG-DM7-HID(A) only)
- Station Number
- IP Address
- Subnet Mask
- Default Gateway
- Mac Address

1. Use the Door Release Keypad to enter "ABAB1234"

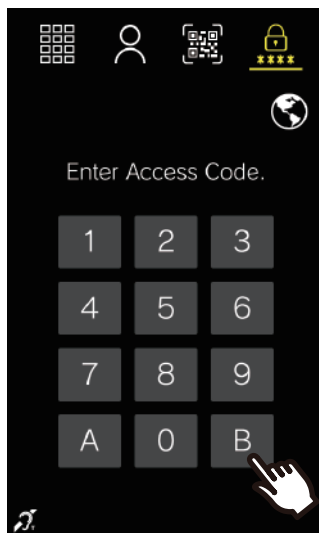

2. Confirm station information.

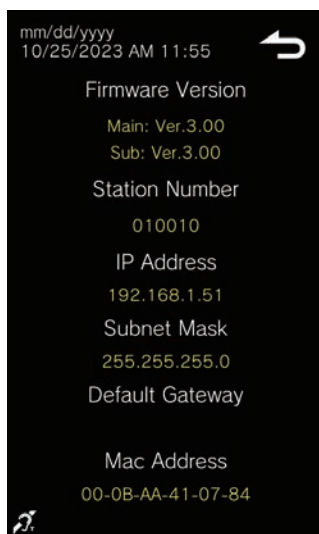

- Tap  to return to the previous screen.



Note

- If "Error" is displayed.
 - The access controller is turned off
 - The sub CPU is disconnected



<https://www.aiphone.net/>

AIPHONE CO., LTD., NAGOYA, JAPAN

Issue Date: Feb. 2024 © 0224 UQ 66115