

# Three-way Ball Valve Type 543



## General

- **Size:** 3/8"–2"
- **Material:** PVC, CPVC, PROGEF® Standard PP, ABS, SYGEF® Standard PVDF
- **Seat:** PTFE
- **Seals:** EPDM or FPM
- **End Connection:** Solvent cement socket, threaded, flanged, fusion spigot, fusion socket
- **Horizontal Mounting:** Stainless steel threaded inserts
- **Horizontal Ball Port:** L-port, T-port
- **Vertical Ball Port:** L-port, diverter

## Key Certifications

- **FDA CFR 21 177.1520:** PP and PVDF
- **FDA CFR 21 177.2600:** EPDM and FPM
- **FDA CFR 21 177.1550:** PTFE
- **USP 25 Class VI (physiological non-toxic):** PP and PVDF

## Sample Specification

The Type 543 3-way Ball Valve shall be available in horizontal and vertical body types. The ball shall be fully molded and full port. The L-port ball shall have blocking capability when in the OFF position. The stem shall be blowout proof, utilizing a double o-ring seal and a predetermined break point opposite the media side of the stem seals. The seat carrier shall be adjustable and reverse threaded. The handle shall double as a seat carrier adjustment or removal tool. Horizontal versions shall utilize a true union connection with a seat carrier on all three ports. Vertical versions shall utilize a true union connection and seat on the two main ports only. The branch connection on vertical versions shall be metric spigot and a metric-ASTM coupling shall be provided. The valve nut threads shall be of buttress type. Ball seats shall have an elastomeric backing o-ring and all elastomeric seals shall be of like material. All valves shall be tested in accordance to ISO9393 and designed to ISO16135 standards. All valves shall be manufactured under ISO9001 for Quality and ISO14001 for Environmental Management. Following assembly, every valve shall be certified bubble tight.

## Material Specification

PVC valves shall meet ASTM D1784 cell classification 12454 standards. CPVC valves shall meet ASTM D1784 cell classification 23447 standards. PP valves shall meet ASTM D5847-14 cell classification PP0510B66851 standards. ABS valves shall meet ASTM D3965 cell classification 42222 standards. PVDF valves shall be type 1, grade 2 according to ASTM D3222 standards. Valves of all materials shall be RoHS compliant.

## Material Availability

Material	Horizontal	Vertical
PVC	All Sizes	All Sizes
CPVC	All Sizes	-
PP	All Sizes	-
ABS	All Sizes	All Sizes
PVDF	All Sizes	-

## Components

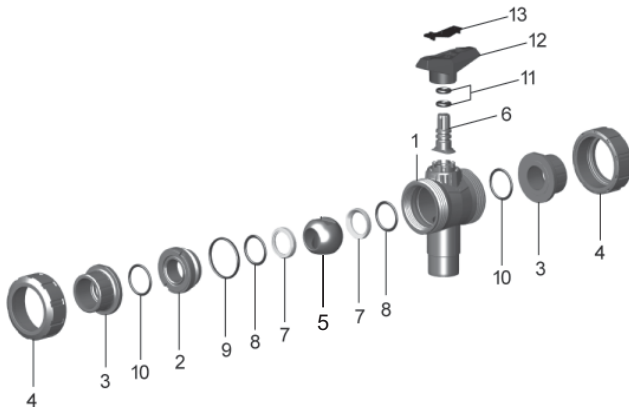

## Optional Features

- **Actuation:** Electric, pneumatic
- **Limit Switches:** Mechanical, inductive
- **Handle:** Lockable handle, handle extension
- **Stop:** 90°, 180° turn limiter
- **Mounting pad:** Additional mounting option for valve base
- **Universal Adapter Kit:** ISO mount for actuation
- **Seals:** Alternative materials available upon request
- **Seat:** PVDF
- **End Connection:** Alternatives available upon request
- **Cleaned:** Silicone free/oil free

### Vertical Valve Components

Part	Description	Material
1	Valve body	PVC, CPVC, PP, ABS or PVDF
2	Seat carrier	PVC, CPVC, PP, ABS or PVDF
3	Valve end	PVC, CPVC, PP, PPn, ABS, PE or PVDF
4	Valve nut	PVC, CPVC, PP, ABS or PVDF
5	Ball	PVC, CPVC, PP, ABS or PVDF
6	Stem	PVC, CPVC, PP, ABS or PVDF
7	Seat	PTFE
8	Backing seal	EPDM or FPM
9	Body seal	EPDM or FPM
10	Face seal	EPDM or FPM
11	Stem seal	EPDM or FPM
12	Handle	Glass-filled PP
13	Handle clip	Glass-filled PP

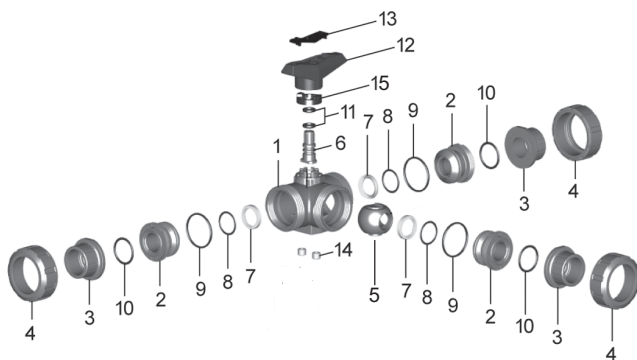

### Horizontal Valve Components

Part	Description	Material
1	Valve body	PVC, CPVC, PP, ABS or PVDF
2	Seat carrier	PVC, CPVC, PP, ABS or PVDF
3	Valve end	PVC, CPVC, PP, PPn, ABS, PE or PVDF
4	Valve nut	PVC, CPVC, PP, ABS or PVDF
5	Ball	PVC, CPVC, PP, ABS or PVDF
6	Stem	PVC, CPVC, PP, ABS or PVDF
7	Seat	PTFE
8	Backing seal	EPDM or FPM
9	Body seal	EPDM or FPM
10	Face seal	EPDM or FPM
11	Stem seal	EPDM or FPM
12	Handle	Glass-filled PP
13	Handle clip	Glass-filled PP
14	Mounting insert	304 Stainless steel
15	Turn limiter	Glass-filled PP

# Technical Data

## Pressure Temperature Curves

The following graphs are based on a 25 year lifetime water or similar media application

### PVC

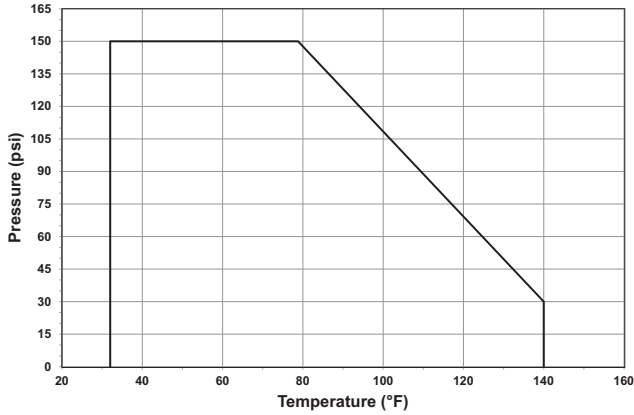

### CPVC

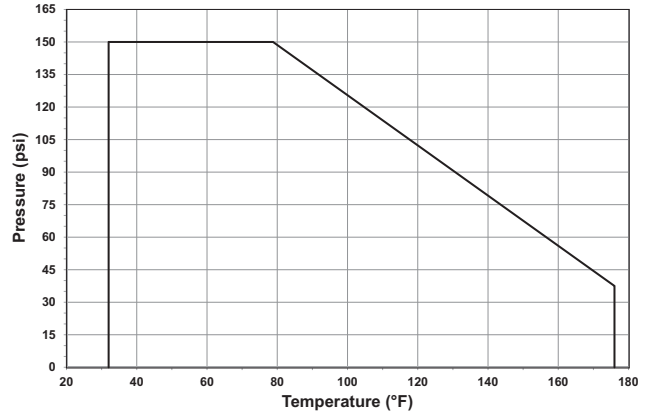

### PP

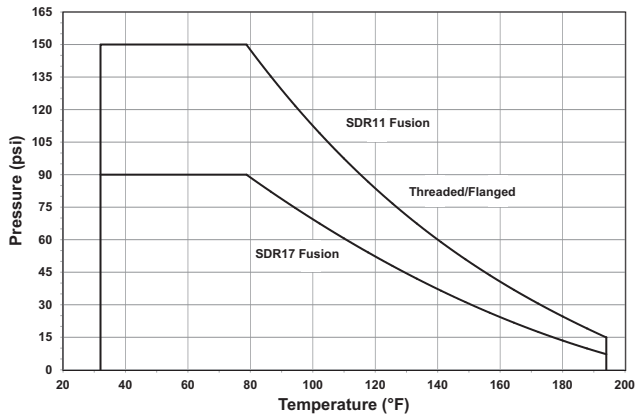

### ABS

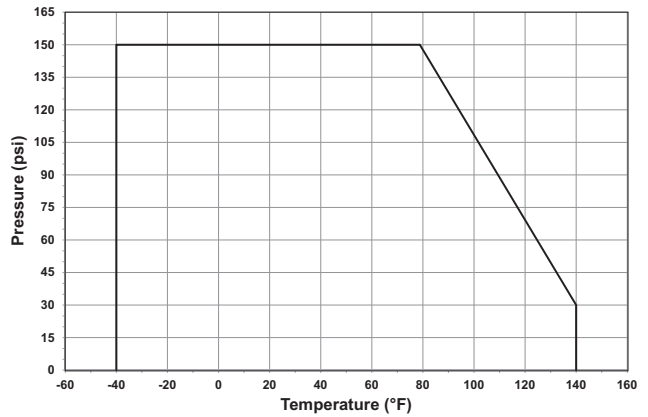

### PVDF

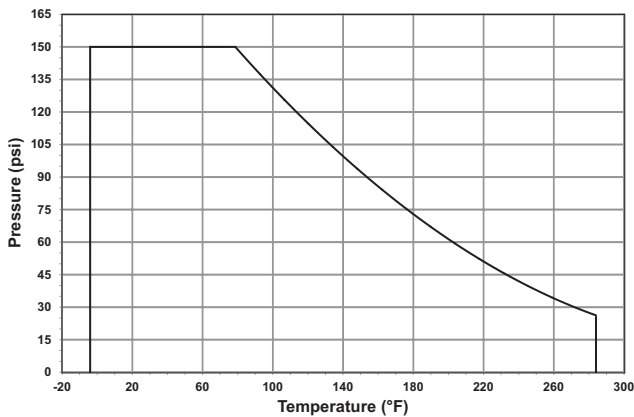

### Pressure-Temperature

Material	Temperature Range (°F)	Max Pressure (psi)
PVC	32 to 140	150
CPVC	32 to 176	150
PP	32 to 176	150*
ABS	-40 to 140	150
PVDF	-4 to 284	150

\*Dependant on end connection as shown in P-T curves

### Vacuum Service

The Type 543 is rated for full vacuum service. Maximum differential pressure of 15psi at 122°F.

# Porting

Options shown turning the valve handle clockwise. Redundant positions not shown.

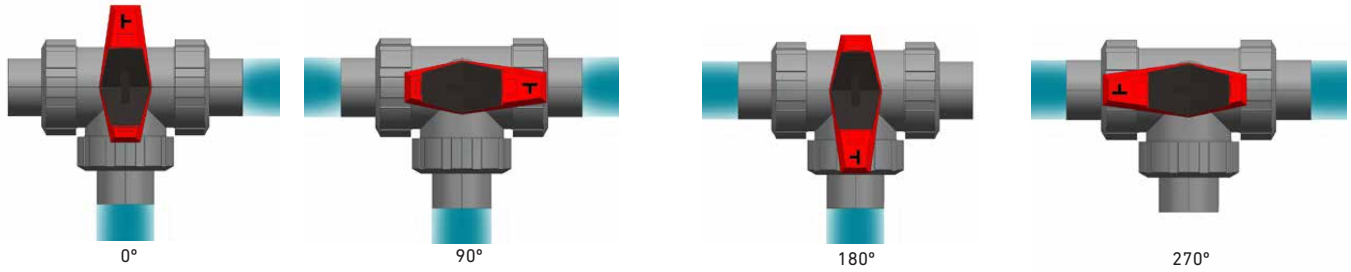

## Flow Horizontal T-port

The following information is based on water applications at 68° F

**Flow Characteristics: C Common (0°–360°)**

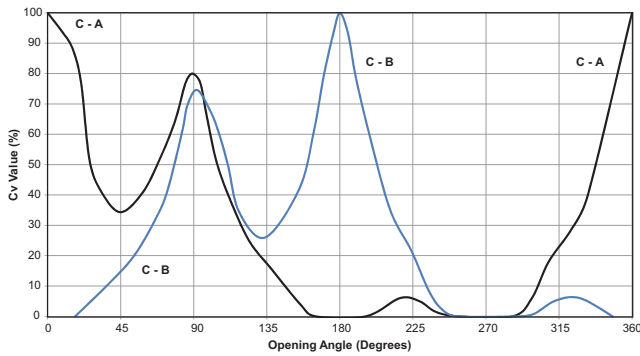

**Flow Characteristics: B Common (0°–360°)**

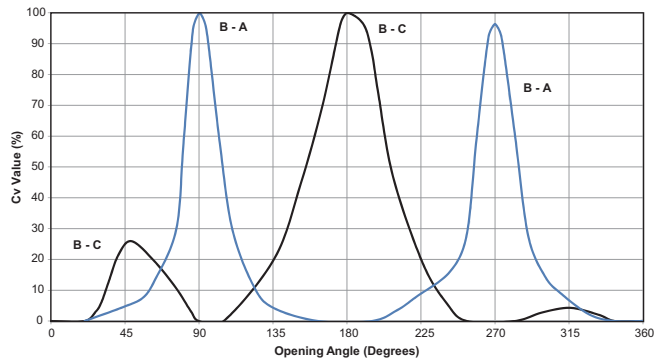

Common is referring to the single port media is flowing either to or from. The A common curve is the same as the B common shifted 180 degrees. Any opening angle with points on both lines indicates flow through both non-common ports.

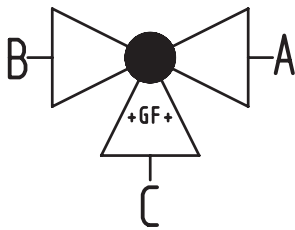

**Cv Value (gal/min)**

Size (inch)	d (mm)	A-B	C-B or C-A	B-C or A-C
3/8	16	9.8	2.5	2.8
1/2	20	14	3.5	4.9
3/4	25	32.9	9.1	10.5
1	32	55.5	14	17.5
1 1/4	40	90.3	26.6	32.9
1 1/2	50	133.7	32.9	42
2	63	217	62.3	84.7

**Flow Characteristics: C Common (45°–135°)**

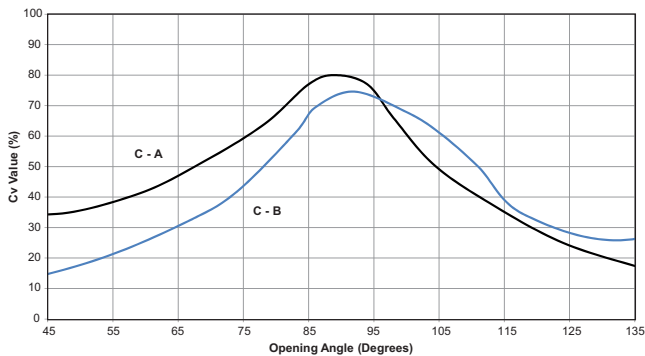

**Flow Characteristics: B Common (0°–90°)**

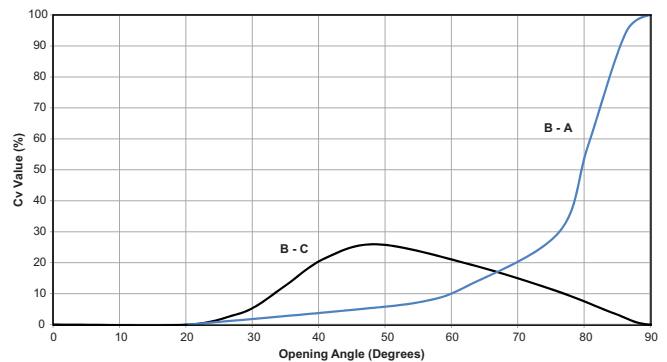

# Porting Horizontal L-port

Options shown turning the valve handle clockwise. Redundant positions not shown.

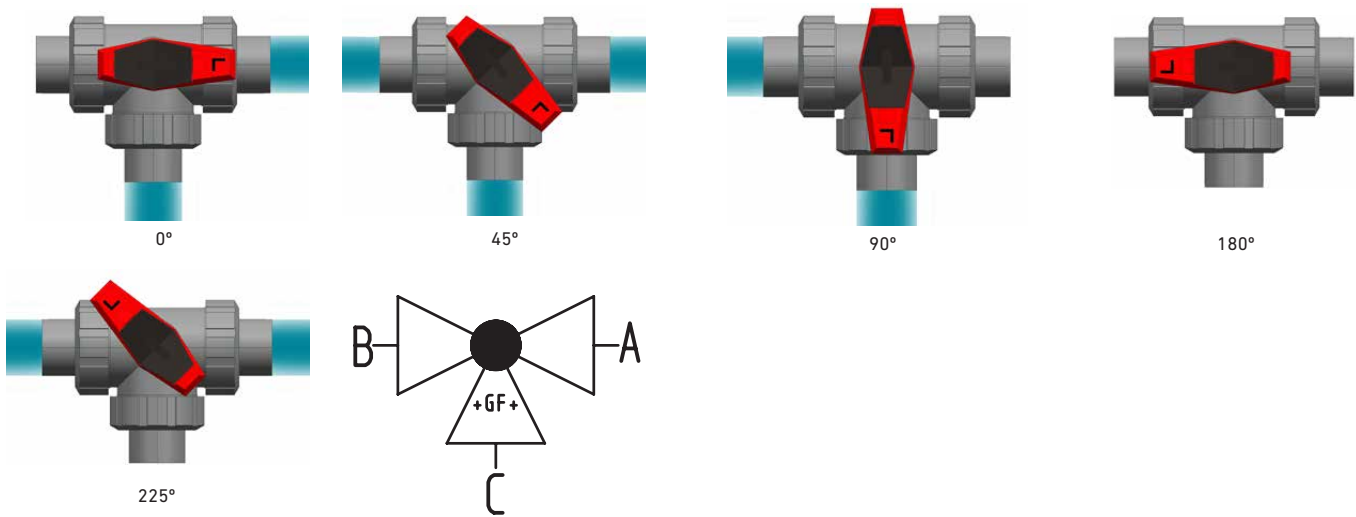

# Flow Horizontal L-port

The following information is based on water applications at 68° F

Flow Characteristics: C Common (0°–90°)

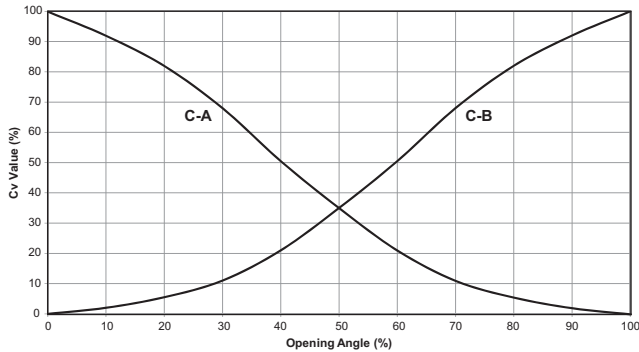

Flow Characteristics: B Common (0°–360°)

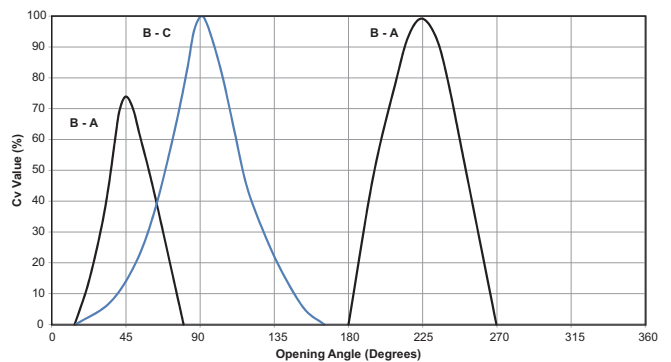

Common is referring to the single port media is flowing either to or from. The A common curve is the same as the B common shifted 180 degrees. Any opening angle with points on both lines indicates flow through both non-common ports.

## Cv Value (gal/min)

Size (inch)	d (mm)	A-B	C-B or C-A	B-C or A-C
3/8	16	0.7	3.5	3.5
1/2	20	1.1	4.5	4.5
3/4	25	2.1	10.5	10.5
1	32	3.5	19.6	19.6
1 1/4	40	6.3	33.6	33.6
1 1/2	50	7.7	43.4	43.4
2	63	15.4	86.1	86.1

Flow Characteristics: B Common (0°–90°)

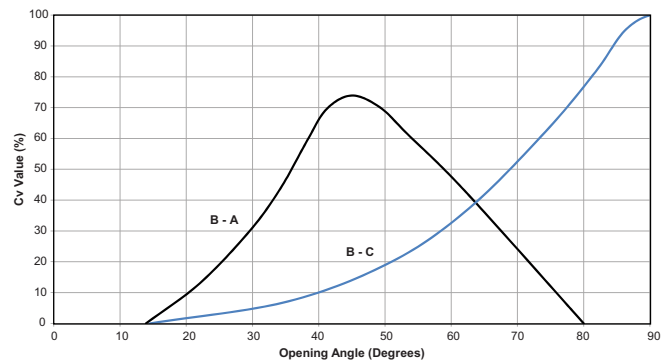

# Porting Vertical

Options shown turning the valve handle clockwise. Redundant positions not shown.

## Vertical L-port

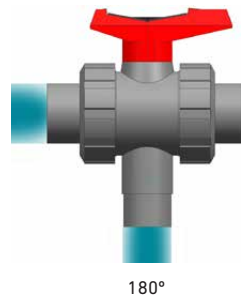
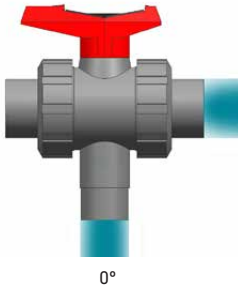

## Vertical Diverter

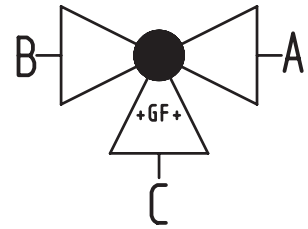
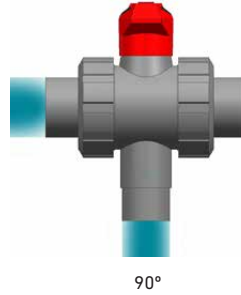
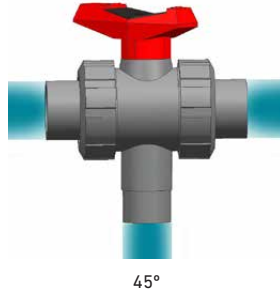

# Flow Vertical

The following information is based on water applications at 68° F

## Flow Characteristics: L-Port, C↔A (90°–180°)

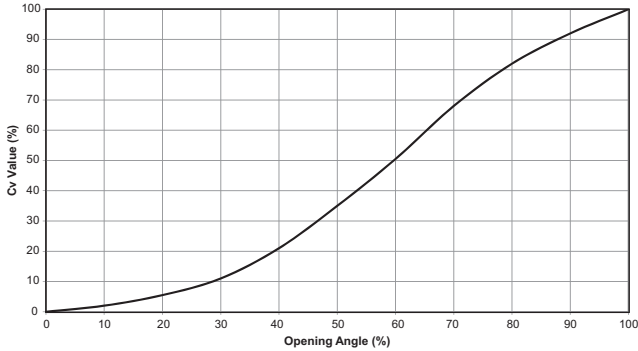

## Flow Characteristics: Diverter

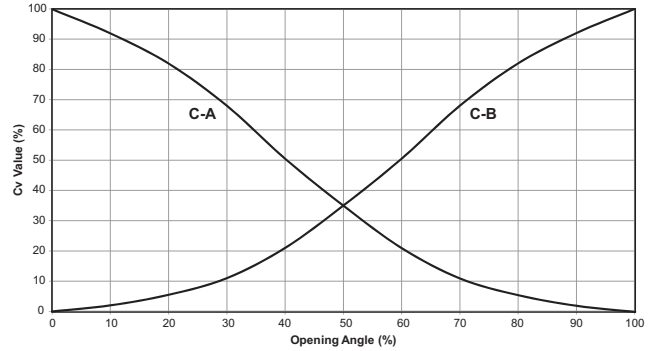

## Flow Characteristics: L-Port, C↔B (0°–90°)

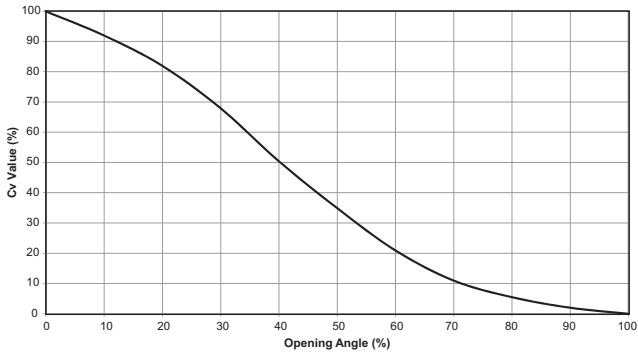

## Cv Value (gal/min)

Size (inch)	d (mm)	A-C or B-C
3/8	16	3.5
1/2	20	5.3
3/4	25	10.5
1	32	19.6
1 1/4	40	33.6
1 1/2	50	43.4
2	63	86.1

# Dimensions

The following tables are shown in millimeters unless otherwise specified

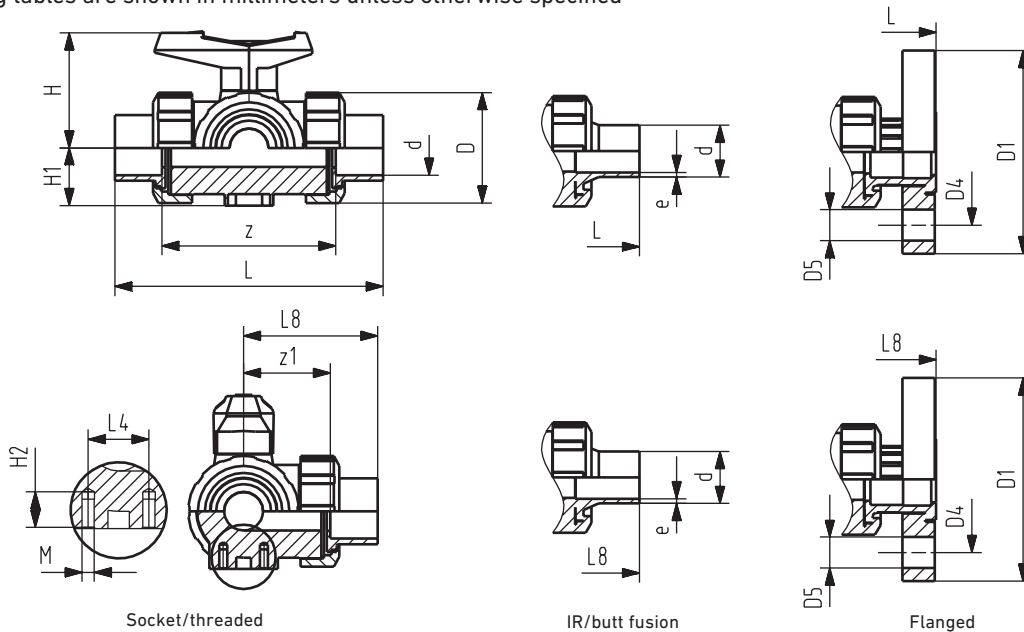

**Type 543 Horizontal: All Materials**

Size (inch)	d (mm)	D	L4	H	H1	H2	M
3/8	16	50	25	57	28	8	M6
1/2	20	50	25	57	28	8	M6
3/4	25	58	25	67	32	8	M6
1	32	68	25	73	36	8	M6
1 1/4	40	84	45	90	45	9	M8
1 1/2	50	97	45	97	51	9	M8
2	63	124	45	116	65	9	M8

**Type 543 Horizontal: ABS**

d (mm)	Metric Socket			
	L	L8	z	z1
16	109	54	81	40
20	112	56	81	40
25	131	65	94	47
32	151	75	107	54
40	181	90	130	65
50	205	103	143	72
63	261	130	185	92

**Type 543 Horizontal: PVC/CPVC**

Size (inch)	IPS Socket				Threaded NPT				Flanged					
	L	L8	z	z1	L	L8	z	z1	L	L1	D1 (inch)	D4 (inch)	D5 (inch)	R (inch)
3/8	123	61	85	42	115	57	87	43	-	-	-	-	-	-
1/2	122	61	77	38	114	57	81	40	161	80	3.5	2.38	0.50	0.57
3/4	141	71	92	46	131	66	96	48	182	91	3.88	2.75	0.50	0.58
1	161	81	105	53	155	78	111	56	208	104	4.25	3.13	0.50	0.66
1 1/4	187	93	126	63	181	90	134	67	238	119	4.63	3.5	0.50	0.69
1 1/2	213	107	143	72	205	103	159	80	265	133	5	3.88	0.50	0.76
2	261	130	185	92	261	130	213	106	323	161	6	4.75	0.63	0.82

**Type 543 Horizontal: PP/PVDF**

d (mm)	Metric Socket				Metric IR/Butt				Threaded NPT			
	L	L8	z	z1	L	L8	e (PP)	e (PVDF)	L	L8	z	z1
16	110	55	82	41	-	-	-	-	112	56	86	43
20	112	56	82	41	146	73	1.9	1.9	114	57	80	40
25	129	65	97	49	163	82	2.3	1.9	131	66	95	48
32	146	73	110	55	178	89	2.9	2.4	154	77	110	55
40	170	85	132	66	204	102	3.7	2.4	180	90	132	66
50	193	98	151	76	237	120	4.6	3.0	203	103	157	79
63	244	123	188	94	296	149	5.8	3.0	258	130	210	105

# Dimensions

The following tables are shown in millimeters unless otherwise specified

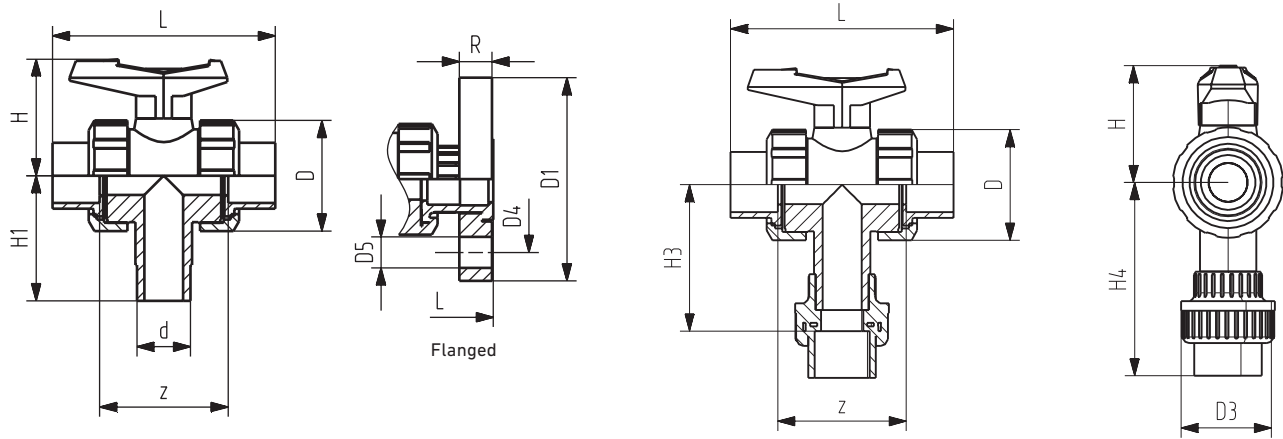

## Type 543 Vertical: All Materials

Size (inch)	d (mm)	D	D3	H	H1
3/8	16	50	35	57	62
1/2	20	50	43	57	62
3/4	25	58	51	67	72
1	32	68	58	73	77
1 1/4	40	84	72	90	87
1 1/2	50	97	83	97	97
2	63	124	100	116	112

## Type 543 Vertical: PVC

Size (inch)	IPS Socket				Threaded NPT			
	L	z	H3	H4	L	z	H3	H4
3/8	106	67	89	108	98	70	90	103
1/2	105	61	90	112	98	64	90	107
3/4	121	70	103	128	112	76	105	123
1	133	76	112	141	127	83	114	135
1 1/4	152	90	125	157	146	99	132	155
1 1/2	165	94	138	173	157	111	154	177
2	183	107	156	194	183	135	187	211

## Type 543 Vertical: ABS

d (mm)	Metric Socket	
	L	z
16	92	64
20	95	64
25	111	74
32	123	79
40	146	95
50	157	95
63	183	107

## Type 543 Vertical: PVC

Size (inch)	ANSI Flanged				
	L	D1 (inch)	D4 (inch)	D5 (inch)	R (inch)
1/2	149	3.5	2.38	0.5	0.57
3/4	165	3.88	2.75	0.5	0.58
1	184	4.25	3.13	0.5	0.66
1 1/4	206	4.63	3.5	0.5	0.69
1 1/2	221	5	3.88	0.5	0.76
2	251	6	4.75	0.63	0.82