

Electrically Actuated 3-Way Ball Valve Type 125/128



General

- **Size:** 3/8"–2"
- **Material:** PVC, CPVC
- **Seat:** PTFE
- **Seals:** EPDM, FPM
- **End Connection:** Solvent cement socket, threaded, flanged
- **Actuator Housing:** Glass-filled PP
- **Voltage:** 100-230VAC
- **Manual Override:** Integrated
- **Position Indicator:** Optical, integrated

Key Valve Certifications

- **FDA CFR 21 177.2600:** EPDM and FPM
- **FDA CFR 21 177.1550:** PTFE

Material Specification

PVC valves shall meet ASTM D1784 cell classification 12454 standards. CPVC valves shall meet ASTM D1784 cell classification 23447-B standards. Valves of all materials shall be RoHS compliant.

Sample Specification

The Type 125/128 3-way Ball Valve shall be used in open/close applications. The actuator shall be a Type EA15. The ball valve shall be true union and utilize a floating ball design. The ball shall be fully molded and full port with two way blocking capability. The stem shall be blowout proof, utilizing a double o-ring seal and a predetermined break point opposite the media side of the stem seals. The seat carrier shall be adjustable and reverse threaded. The valve nut threads shall be of buttress type. Ball seats shall have an elastomeric backing o-ring and all elastomeric seals shall be of like material. ANSI flanged versions shall meet ANSI B16.5 150lb standards. All valves shall be tested in accordance to ISO9393 and designed to ISO16135 standards. All valves shall be manufactured under ISO9001 for Quality and ISO14001 for Environmental Management. Following manual assembly, every valve shall be tested and certified bubble tight exceeding Class VI standards. Following actuated assembly, every valve shall be tested to confirm functionality.

Key Actuator Certifications

- Machinery Directive 2006/42/EC, Annex II B
- EMV Directive CE 2004/108/CE
- EMV VDE 0843 Section 20
- Low Voltage Directive CE 2006/95/CE
- Vibration Testing EN 60068-2-6
- Interface ISO 5211
- Actuators for Industrial Valves EN 15714-2

Wiring Diagrams

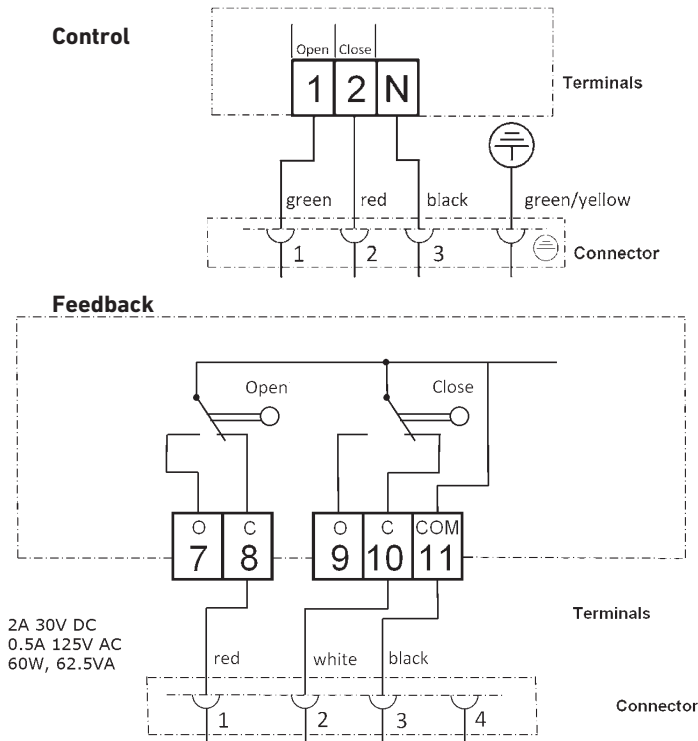

Definition of Valve Style



Horizontal



Vertical

Definition of Valve Type

- **Type 125:** PVC/CPVC horizontal
- **Type 128:** PVC vertical

Material Availability

Material	Horizontal	Vertical
PVC	All Sizes	All Sizes
CPVC	All Sizes	-

Components



Actuator Technical Data

	EA 15
Cycle Time	5s/90°
Cycles at 70°F	150,000
Housing Material	Glass-filled PP
Position Indicator	Optical, integrated LED for visual communication of position and actuator status
Emergency Manual Override	Integrated
Rated Voltage	100–230VAC, 50/60 Hz
Rated Voltage Tolerance	+/- 15%
Nominal Output	35VA
Calculated Current Draw	0.3A @ 100VAC 0.13A @ 230VAC
Duty Cycle	40%
Position Feedback	Bi-stable, 250V, 2A
Protection Class	IP67 per EN 60529, UL/CSA: For interior use, NEMA 4X
Ambient Temperature	14°F to 122°F (2)
Allowable Humidity	90% relative humidity, non condensing

(1) Overload protection of the motor is dimensioned so that the motor and the power supply board are protected. As soon as the load is within the torque range, the actuator will begin operating again.

(2) At temperatures below 14°F and if there is condensation, the heating element should be activated.

Pressure Temperature Curves

The following graphs are based on a 25 year lifetime water or similar media application

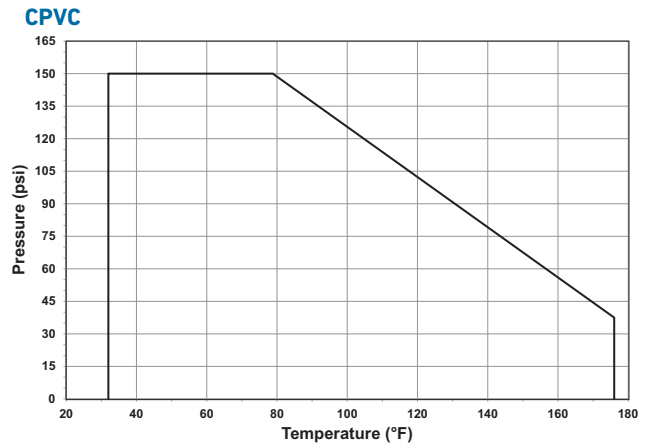
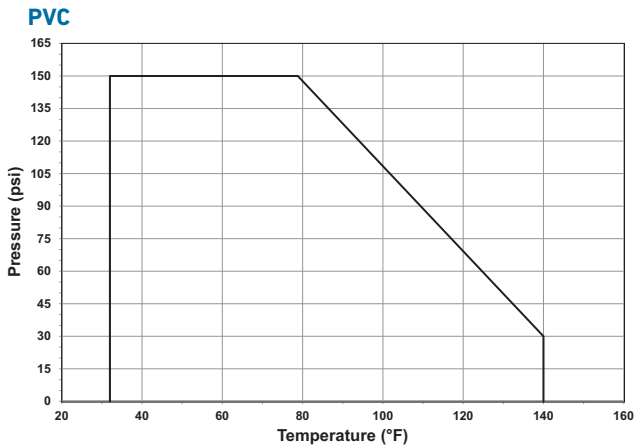

Flow

Porting options shown turning the valve rotating clockwise. Redundant and intermediate positions not shown.

Vertical Diverter

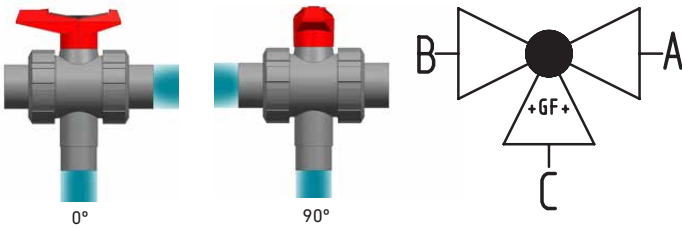

Vertical: Cv Value (gal/min)

Size (inch)	d (mm)	A-C or B-C
3/8	16	3.5
1/2	20	5.3
3/4	25	10.5
1	32	19.6
1 1/4	40	33.6
1 1/2	50	43.4
2	63	86.1

Vertical L-port

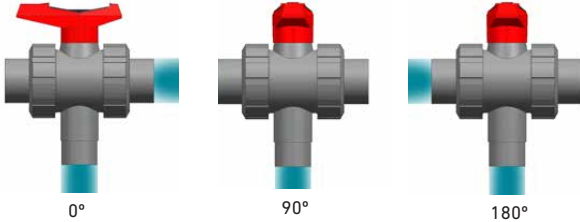

Horizontal L-port: Cv Value (gal/min)

Size (inch)	d (mm)	A-B	C-B or C-A	B-C or A-C
3/8	16	0.7	3.5	3.5
1/2	20	1.1	4.5	4.5
3/4	25	2.1	10.5	10.5
1	32	3.5	19.6	19.6
1 1/4	40	6.3	33.6	33.6
1 1/2	50	7.7	43.4	43.4
2	63	15.4	86.1	86.1

Horizontal L-port



Horizontal T-port: Cv Value (gal/min)

Size (inch)	d (mm)	A-B	C-B or C-A	B-C or A-C
3/8	16	9.8	2.5	2.8
1/2	20	14	3.5	4.9
3/4	25	32.9	9.1	10.5
1	32	55.5	14	17.5
1 1/4	40	90.3	26.6	32.9
1 1/2	50	133.7	32.9	42
2	63	217	62.3	84.7

Horizontal T-port

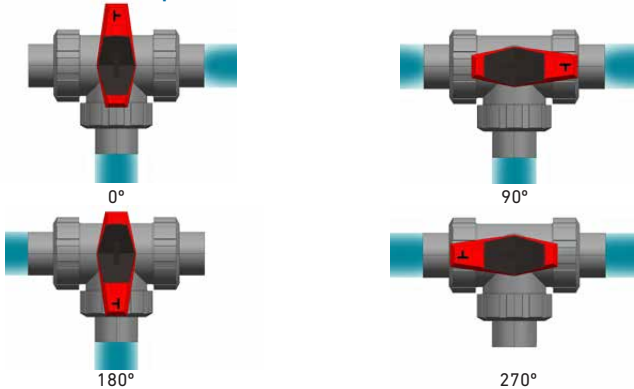

Dimensions

The following tables are shown in millimeters unless otherwise specified

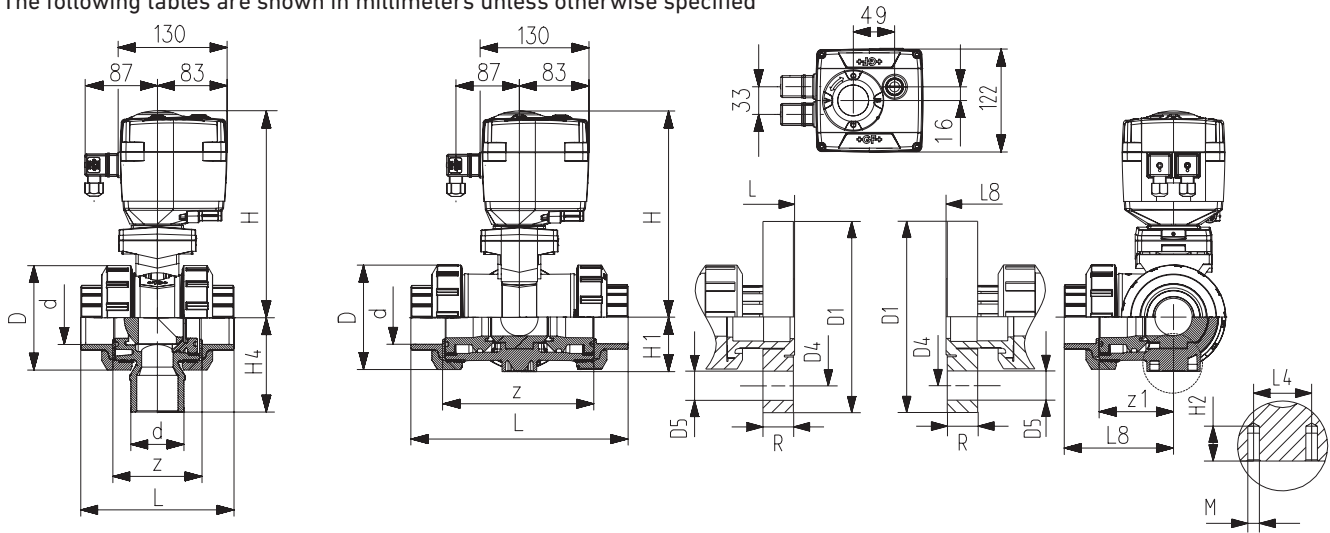

Type 125/128: All Configurations

Size (inch)	d (mm)	D	H	H1	H2	H3	H4	L4	M
3/8	16	50	201	28	8	28	62	25	M6
1/2	20	50	201	28	8	28	62	25	M6
3/4	25	58	210	32	8	32	71	25	M6
1	32	68	210	36	8	36	77	25	M6
1 1/4	40	84	221	45	9	45	87	45	M8
1 1/2	50	97	221	51	9	51	97	45	M8
2	63	124	243	65	9	65	112	45	M8

Type 128: PVC

Size (inch)	IPS Socket		Threaded NPT		ANSI Flanged				
	L	z	L	z	L	D1 (inch)	D4 (inch)	D5 (inch)	R (inch)
3/8	106	67	98	70	-	-	-	-	-
1/2	105	61	98	64	149	3.5	2.38	0.63	0.57
3/4	121	70	112	76	165	3.88	2.75	0.63	0.58
1	133	76	127	83	184	4.25	3.13	0.63	0.66
1 1/4	152	90	146	99	206	4.63	3.5	0.63	0.69
1 1/2	165	94	157	111	221	5	3.88	0.63	0.76
2	183	107	183	135	251	6	4.75	0.63	0.82

Type 125: PVC/CPVC

Size	IPS Socket				Threaded NPT				ANSI Flanged					
	L	L8	z	z1	L	L8	z	z1	L	L1	D1 (inch)	D4 (inch)	D5 (inch)	R (inch)
3/8	123	61	85	42	115	57	87	43	-	-	-	-	-	-
1/2	122	61	77	38	114	57	81	40	161	80	3.5	2.38	0.50	0.57
3/4	141	71	92	46	131	66	96	48	182	91	3.88	2.75	0.50	0.58
1	161	81	105	53	155	78	111	56	208	104	4.25	3.13	0.50	0.66
1 1/4	187	93	126	63	181	90	134	67	238	119	4.63	3.5	0.50	0.69
1 1/2	213	107	143	72	205	103	159	80	265	133	5	3.88	0.50	0.76
2	261	130	185	92	261	130	213	106	323	161	6	4.75	0.63	0.82