

GF Piping Systems

Global Product Range

Solenoid & Pilot Valves

Types 157, 160, 161, 165, 166,
Types PV94, PV95, MNL532, 5470, PV2000



Regulating flow in an easy, safe and economical way

Solenoid Valves

Function

The solenoid valves Type 157, 160, 161, 166 are valves, which are actuated by an electromagnet. Their tasks are to release, shut off, dose, distribute or mix gases and liquids. The solenoid valves can switch very fast, and guarantee high reliability and a long lifetime at a low actuator power. With servo assisted solenoid valves Type 165, it is possible to switch large valves with low power, as only a small coil needs to be energized. In this way, smaller electromagnets with lower power can be used. This also reduces the weight of the valve.

Benefits

- Safety position opened/closed in rest position
- Short cycle times
- High number of cycles possible
- Defined end positions
- Compact design
- Low maintenance
- No compressed air needed
- Robust manual override
- Protection class IP65

Applications

- Water treatment
- Process/chemical engineering
- Plant/mechanical engineering
- Semiconductor industry
- Environmental engineering
- Medical engineering
- Apparatus engineering
- Analytical technology



Solenoid Pilot Valves

Function

Solenoid pilot valves type PV94, PV95, MNL532, 5470 and PV2000 are used to open and close pneumatic actuated valves by pilot controlling the pneumatic actuators. With these it is possible to switch large valves with low power and less compressed air, as only a small coil needs to be energized and a small working chamber is filled with compressed air. Please note that a NAMUR connector plate is required for the installation of type MNL532 and 5470 (see accessories). PV2000 is a valve cluster consisting of several solenoid pilot valves. This is used to control several pneumatic actuators. The valve cluster can also be controlled via field bus systems.

Benefits

- Direct acting and compact small valve
- Easy direct attachment to a pneumatic actuator
- Service-friendly manual override
- Variant for double-acting actuators available
- Easy adaptation to different actuator sizes possible
- Low compressed air loss during switching operation



Product portfolio

Solenoid Valves for fluid processing



Type 157
Straight-through valve



Type 160/161
Straight-through / mixing valve



Type 165
Straight-through valve



Type 166
Straight-through / mixing / distribution valve

Function	2/2 ways	2/2 or 3/2 ways	2/2 ways	2/2 or 3/2 ways
Dimension	DN4 – DN8	DN10 – DN20	DN15 – DN50	DN3 – DN5
Pressure [bar]	0 – 4	0 – 3	0.5 – 6	0 – 10
Kv-Value [m³/h]	0.3 – 1	2 – 6	5 – 36	0.25 – 0.4
Material	PVC-U	PVC-U	PVC-U, PVDF	PP-H, PVDF
Sealing material	EPDM, FKM	EPDM, FKM	EPDM, FKM	EPDM, FKM
Control mode	FC, FO	FC, FO	FC	FC, FO
Voltage	24 V / 230 V	24 V / 230 V	24 V / 110 V / 230 V	24 V / 230 V

Solenoid Pilot Valves for pneumatic actuators



Type PV94
For single acting actuators



Type PV95
For single acting actuators



Type MNL532
For single & double acting actuators



Type 5470
For double acting actuators

Function	3/2 ways	3/2 ways	3/2 & 5/2 ways	4/2 ways
Dimension	DN1.2	DN2	5.5 mm	DN4
Pressure	0 – 10 bar	0 – 10 bar	2 – 10 bar	2 – 10 bar
Material	PA, brass	PA, brass	Aluminium	PA
Voltage	230 V / 110 V / 24 V	230 V / 110 V / 24 V	230 V / 110 V / 48 V / 24 V	230 V / 110 V / 24 V
Compressed air connection	NPT 1/8" / G 1/8" / push-in 6 mm	NPT 1/8" / G 1/4"	G 1/4"	G 1/8"
Actuator connection	G 1/8"	G 1/4" / G 1/8"	NAMUR	NAMUR
Air flow	48 l/min	120 l/min	950 l/min	300 l/min

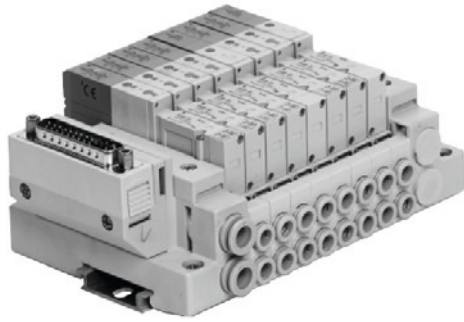

PV2000
Pilot valve cluster

Function	3/2 or 5/2 ways
Max. number of solenoids	18
Operating Pressure [bar]	1.5 – 7
Air flow [l/min]	~220
Voltage	24 V DC / 100%

Choose the right pilot valve for pneumatic actuators



≤ DN65

> DN65

Single acting actuators (FC/FO)	PV94 MNL532	PV95 MNL532
Double acting actuators (DA)	MNL532 5470	MNL532 5470

Circuit function

2/2-Way Valves

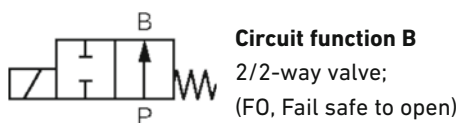
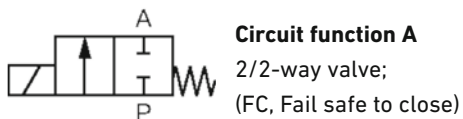

3/2-Way Valves

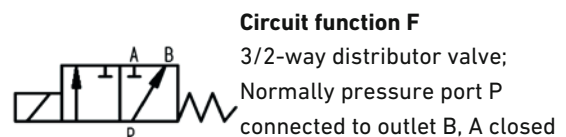
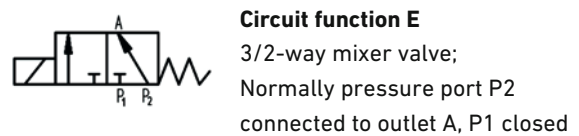
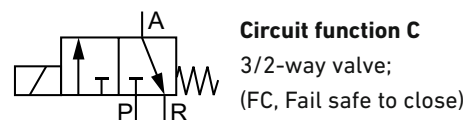

You can find more information in our [Planning Fundamentals Industry - Process Automation](#).

Solenoid & Pilot Valves

Global Product Range



Solenoid valves



Solenoid valve type 157 PVC-U Straight-through valve 2/2 ways

Model:

- Material PVC-U: with threaded sockets parallel female thread Rp
- With manual override
- Electrical connection: cable plug
- Protection class IP 65
- Circuit function A: FC, closed in rest position
- Circuit function B: FO, opened in rest position

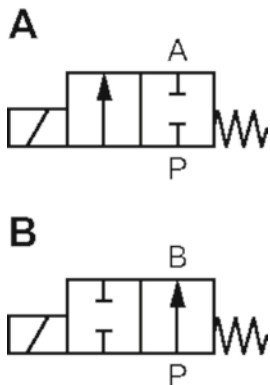

DN (mm)	PN (bar)	kv-value ($\Delta p=1$ bar) (l/min)	Inner Thread (inch)	Voltage	Function	EPDM Code	FKM Code
4	0 - 4	50	G3/8	24V DC	B	199 157 647	
6	0 - 2	100	G3/8	24V DC	B	199 157 648	
4	0 - 4	50	G3/8	230V 50Hz \pm 10%	B	199 157 027	199 157 022
6	0 - 2	100	G3/8	230V 50Hz \pm 10%	B	199 157 028	
8	0 - 1	167	G3/8	230V 50Hz \pm 10%	B	199 157 029	
4	0 - 4	50	G3/8	24V DC	A	199 157 627	199 157 622
6	0 - 1	100	G3/8	24V DC	A	199 157 628	199 157 623
8	0 - 1	167	G3/8	24V AC/DC	A	199 157 629	199 157 624
4	0 - 4	50	G3/8	230V 50Hz \pm 10%	A	199 157 007	199 157 002
6	0 - 2	100	G3/8	230V 50Hz \pm 10%	A	199 157 008	199 157 003
8	0 - 1	167	G3/8	230V 50Hz \pm 10%	A	199 157 009	199 157 004

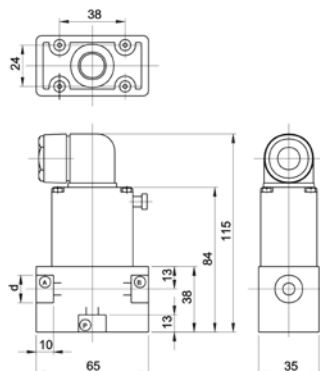



Solenoid valve type 160 PVC-U
Straight through valve 2/2 ways

Model:

- Material: PVC-U
- With solvent cement socket metric
- With manual override
- Electrical connection: cable plug
- Protection class IP 65
- Circuit function A: FC, closed in rest position
- Circuit function B: FO, opened in rest position

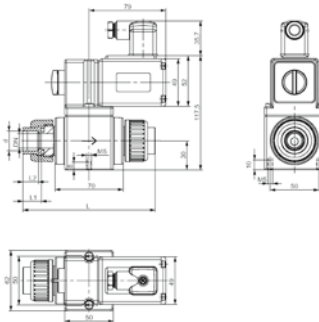
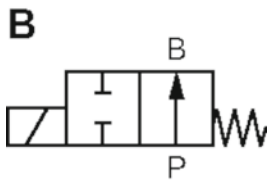
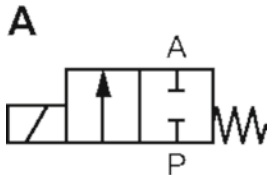

d (mm)	DN (mm)	Size (inch)	PN (bar)	kv-value ($\Delta p=1$ bar) (l/min)	Voltage	Function	EPDM Code	FKM Code
16	10	3/8	3.0	33	230V 50Hz \pm 10%	A	199 160 010	199 160 005
20	10	1/2	3.0	33	230V 50Hz \pm 10%	A	199 160 011	199 160 006
20	15	1/2	1.0	75	230V 50Hz \pm 10%	A	199 160 012	199 160 007
25	15	1/2	1.0	75	230V 50Hz \pm 10%	A	199 160 013	199 160 008
25	20	3/4	0.5	100	230V 50Hz \pm 10%	A	199 160 014	199 160 009
16	10	3/8	2.0	33	230V 50Hz \pm 10%	B	199 160 025	199 160 020
20	10	1/2	1.0	33	230V 50Hz \pm 10%	B	199 160 026	199 160 021
20	15	1/2	1.0	75	230V 50Hz \pm 10%	B	199 160 027	199 160 022
25	15	3/4	1.0	75	230V 50Hz \pm 10%	B	199 160 028	199 160 023
25	20	3/4	0.5	100	230V 50Hz \pm 10%	B	199 160 029	199 160 024
16	10	3/8	3.0	33	24V AC/DC	A	199 160 370	199 160 365
20	10	1/2	3.0	33	24V AC/DC	A	199 160 371	199 160 366
20	15	1/2	1.0	75	24V AC/DC	A	199 160 372	199 160 367
25	15	3/4	1.0	75	24V AC/DC	A	199 160 373	
25	20	3/4	0.5	100	24V AC/DC	A	199 160 374	199 160 369
16	10	3/8	2.0	33	24V AC/DC	B	199 160 385	199 160 380
20	10	1/2	2.0	33	24V AC/DC	B	199 160 386	199 160 381
25	20	3/4	0.5	100	24V AC/DC	B	199 160 389	

d (mm)	DN (mm)	L (mm)	L1 (mm)	L2 (mm)
16	10	130	17	14
20	10	134	19	16
20	15	136	19	16
25	15	142	22	19
25	20	144	22	19
16	10	130	17	14
20	10	134	19	16
20	15	136	19	16
25	15	142	19	19
25	20	144	22	19
16	10	130	17	14
20	10	134	19	16
20	15	136	19	16
25	15	142	22	19
25	20	144	22	19
16	10	130	17	14
20	10	134	19	16
25	20	144	22	19

Solenoid valve type 161 PVC-U
Mixing valve 3/2 ways

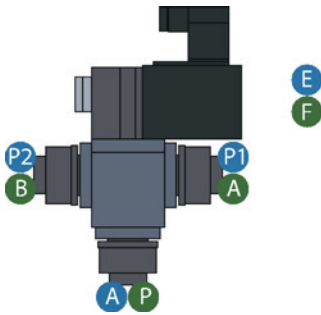

E
F

Model:

- Material: PVC-U
- With solvent cement socket metric
- With manual override
- Electrical connection: cable plug
- Protection class IP 65
- Circuit function E: In rest position, pressure connection P2 connected to outlet A. P1 closed
- Circuit function F: In rest position, pressure connection P connected to outlet B. A closed

d (mm)	DN (mm)	PN (bar)	kv-value ($\Delta p=1$ bar) (l/min)	Voltage	Function	EPDM Code	FKM Code
16	10	0.60	33	230V 50Hz \pm 10%	E		199 161 035
20	15	0.30	67	230V 50Hz \pm 10%	E		199 161 037
25	20	0.15	83	230V 50Hz \pm 10%	E	199 161 044	199 161 039
20	10	1.00	33	230V 50Hz \pm 10%	F		199 161 051
20	15	0.50	67	230V 50Hz \pm 10%	F	199 161 057	199 161 052
25	20	0.15	83	24V AC/DC	E	199 161 434	199 161 429
16	10	0.60	33	24V AC/DC	E	199 161 430	
20	15	0.30	67	24V AC/DC	E	199 161 432	
25	15	0.30	67	24V AC/DC	E	199 161 433	
16	10	1.00	33	24V AC/DC	F	199 161 445	
20	15	0.50	67	24V AC/DC	F	199 161 447	
25	20	0.25	83	24V AC/DC	F	199 161 449	
16	10	1.00	33	230V 50Hz \pm 10%	F	199 161 055	
25	20	0.25	83	230V 50Hz \pm 10%	F	199 161 059	
25	15		67	230V 50Hz \pm 10%	F	199 158 058	

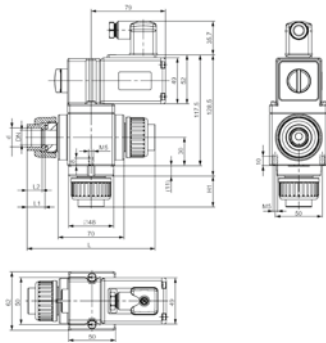
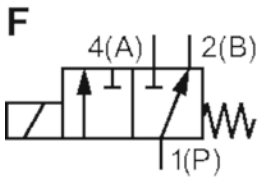
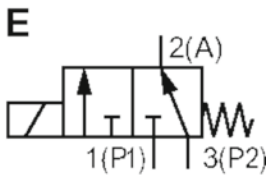

d (mm)	DN (mm)	Size (inch)	L (mm)	L2 (mm)	H1 (mm)	L1 (mm)
16	10	3/8	130	14	30	17
20	15	3/8	136	16	33	19
25	20	1/2	144	19	37	22
20	10	1/2	134	14	32	19
20	15	3/8	136	16	33	19
25	20	3/4	144	19	37	22
16	10	3/8	130	14	30	17
20	15	1/2	136	16	33	19
25	15	3/4	142	16	36	22
16	10	3/4	130	14	30	17
20	15	1/2	136	16	33	19
25	20	3/4	144	19	37	22
16	10	1/2	130	14	30	17
25	20	3/4	144	19	37	22
25	15	1/2	142	16	32	22



Solenoid valve type 165 PVC-U
Straight-through valve 2/2 ways/230V 50Hz/60Hz

Model:

- PN 0.5-6bar
- Material PVC-U: with solvent cement socket metric
- Protection class IP 65
- Electrical connection: cable plug
- With manual override
- Circuit function A: FC, closed in rest position

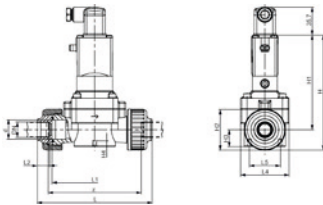
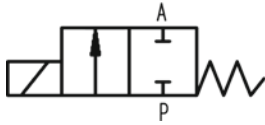

d (mm)	DN (mm)	Size (inch)	PN (bar)	kv-value ($\Delta p=1$ bar) (l/min)	PVC-U EPDM Code	PVC-U FKM Code
20	15	1/2	6	83	199 165 012	199 165 002
25	20	3/4	6	100	199 165 013	199 165 003
32	25	1	6	233	199 165 014	199 165 004
40	32	1 1/4	6	267	199 165 015	199 165 005
50	40	1 1/2	6	500	199 165 016	
63	50	2	6	600	199 165 017	199 165 007

d (mm)	H (mm)	H1 (mm)	H2 (mm)	H3 (mm)	H4 (mm)	L (mm)	L1 (mm)	L2 (mm)	L4 (mm)	L5 (mm)	z (mm)
20	148	122	53	22	8	148	110	16	63	40	116
25	148	122	53	22	8	154	110	19	62	40	116
32	175	137	76	31	15	190	141	22	85	45	147
40	175	137	76	31	15	198	141	26	85	45	147
50	212	160	105	42	15	254	192	31	115	45	198
63	212	160	105	42	15	268	192	38	115	45	198



SYGEF Standard Solenoid valve type 165
Straight-through valve 2/2 ways/230V 50Hz/60Hz

Model:

- PN 0.5-6bar
- Material PVDF: with fusion socket metric
- Protection class IP 65
- Electrical connection: cable plug
- With manual override
- Circuit function A: FC, closed in rest position

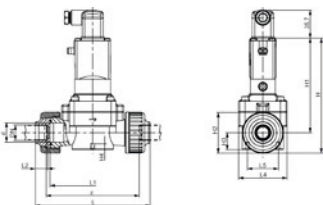
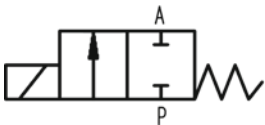

d (mm)	DN (mm)	Size (inch)	PN (bar)	kv-value ($\Delta p=1$ bar) (l/min)	PVDF EPDM Code	PVDF FKM Code
20	15	1/2	6	83	199 165 412	199 165 402
25	20	3/4	6	100	199 165 413	199 165 403
32	25	1	6	233	199 165 414	199 165 404
40	32	1 1/4	6	500	199 165 415	199 165 405
50	40	1 1/2	6	500	199 165 416	
63	50	2	6	600	199 165 417	

d (mm)	H (mm)	H1 (mm)	H2 (mm)	H3 (mm)	H4 (mm)	L (mm)	L1 (mm)	L2 (mm)	L4 (mm)	L5 (mm)	z (mm)
20	148	122	53	22	8	147	109	16	63	40	120
25	148	122	53	22	8	151	109	18	62	40	120
32	175	137	76	31	15	185	139	20	85	45	150
40	175	137	76	31	15	189	139	22	85	45	150
50	212	160	105	42	15	245	189	25	115	45	200
63	212	160	105	42	15	253	189	29	115	45	200



Solenoid valve type 165 PVC-U
Straight-through valve 2/2 ways/110V 50Hz/60Hz

Model:

- PN 0.5-6bar
- Material PVC-U: with solvent cement socket metric
- Protection class IP 65
- Electrical connection: cable plug
- With manual override
- Circuit function A: FC, closed in rest position

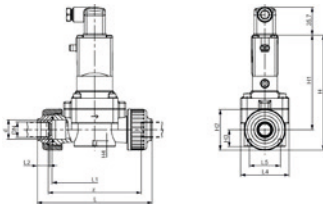
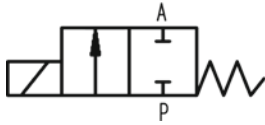

d (mm)	DN (mm)	Size (inch)	PN (bar)	kv-value ($\Delta p=1$ bar) (L/min)	PVC-U EPDM Code	PVC-U FKM Code
20	15	1/2	6	83	199 165 042	199 165 032
25	20	3/4	6	100	199 165 043	199 165 033
32	25	1	6	233	199 165 044	199 165 034
40	32	1 1/4	6	267	199 165 045	
50	40	1 1/2	6	500	199 165 046	
63	50	2	6	600	199 165 047	

d (mm)	H (mm)	H1 (mm)	H2 (mm)	H3 (mm)	H4 (mm)	L (mm)	L1 (mm)	L2 (mm)	L4 (mm)	L5 (mm)	z (mm)
20	148	122	53	22	8	148	110	16	63	40	116
25	148	122	53	22	8	154	110	19	62	40	116
32	175	137	76	31	15	190	141	22	85	45	147
40	175	137	76	31	15	198	141	26	85	45	147
50	212	160	105	42	15	254	192	31	115	45	198
63	212	160	105	42	15	268	192	38	115	45	198



SYGEF Standard Solenoid valve type 165
Straight-through valve 2/2 ways/110V 50Hz/60Hz

Model:

- PN 0.5-6bar
- Material PVDF: with fusion socket metric
- Protection class IP 65
- Electrical connection: cable plug
- With manual override
- Circuit function A: FC, closed in rest position

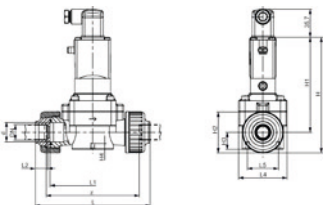
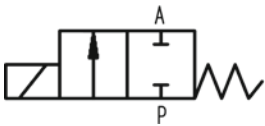

d (mm)	DN (mm)	Size (inch)	PN (bar)	kv-value ($\Delta p=1$ bar) (L/min)	PVDF EPDM Code	PVDF FKM Code
20	15	1/2	6	83	199 165 442	199 165 432
25	20	3/4	6	100	199 165 443	199 165 433
32	25	1	6	233	199 165 444	199 165 434

d (mm)	H (mm)	H1 (mm)	H2 (mm)	H3 (mm)	H4 (mm)	L (mm)	L1 (mm)	L2 (mm)	L4 (mm)	L5 (mm)	z (mm)
20	148	122	53	22	8	147	109	16	63	40	120
25	148	122	53	22	8	151	109	18	62	40	120
32	175	137	76	31	15	185	139	20	85	45	150



Solenoid valve type 165 PVC-U Straight-through valve 2/2 ways/24V DC

Model:

- PN 0.5-6bar
- Material PVC-U: with solvent cement socket metric
- Protection class IP 65
- Electrical connection: cable plug
- With manual override
- Circuit function A: FC, closed in rest position

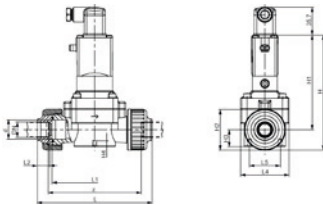
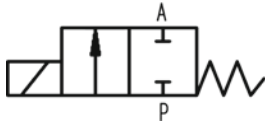

d (mm)	DN (mm)	Size (inch)	PN (bar)	kv-value ($\Delta p=1$ bar) (L/min)	PVC-U EPDM Code	PVC-U FKM Code
20	15	1/2	6	83	199 165 022	199 165 072
25	20	3/4	6	100	199 165 023	199 165 073
32	25	1	6	233	199 165 024	199 165 074
40	32	1 1/4	6	267	199 165 025	199 165 075
50	40	1 1/2	6	500	199 165 026	199 165 076
63	50	2	6	600	199 165 027	199 165 077

d (mm)	H (mm)	H1 (mm)	H2 (mm)	H3 (mm)	H4 (mm)	L (mm)	L1 (mm)	L2 (mm)	L4 (mm)	L5 (mm)	z (mm)
20	148	122	53	22	8	148	110	16	63	40	116
25	148	122	53	22	8	154	110	19	62	40	116
32	175	137	76	31	15	190	141	22	85	45	147
40	175	137	76	31	15	198	141	26	85	45	147
50	212	160	105	42	15	254	192	31	115	45	198
63	212	160	105	42	15	268	192	38	115	45	198



SYGEF Standard Solenoid valve type 165 Straight-through valve 2/2 ways/24V DC

Model:

- PN 0.5-6bar
- Material PVDF: with fusion socket metric
- Protection class IP 65
- Electrical connection: cable plug
- With manual override
- Circuit function A: FC, closed in rest position

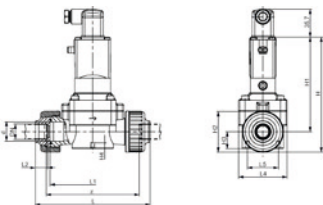
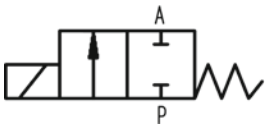

d (mm)	DN (mm)	Size (inch)	PN (bar)	kv-value ($\Delta p=1$ bar) (L/min)	PVDF EPDM Code	PVDF FKM Code
20	15	1/2	6	83	199 165 422	199 165 452
25	20	3/4	6	100	199 165 423	199 165 453
32	25	1	6	233	199 165 424	199 165 454
40	32	1 1/4	6	267	199 165 425	199 165 455
50	40	1 1/2	6	500	199 165 426	
63	50	2	6	600	199 165 427	199 165 457

d (mm)	H (mm)	H1 (mm)	H2 (mm)	H3 (mm)	H4 (mm)	L (mm)	L1 (mm)	L2 (mm)	L4 (mm)	L5 (mm)	z (mm)
20	148	122	53	22	8	147	109	16	63	40	120
25	148	122	53	22	8	151	109	18	62	40	120
32	175	137	76	31	15	185	139	20	85	45	150
40	175	137	76	31	15	189	139	22	85	45	150
50	212	160	105	42	15	245	189	25	115	45	200
63	212	160	105	42	15	253	189	29	115	45	200



PROGEF Standard Solenoid valve type 166
Straight-through valve 2/2 ways

Model:

- Material: PP-H
- With manual override
- Electrical connection: cable plug
- Protection class IP 65
- Circuit function A: FC, closed in rest position

DN (mm)	PN (bar)	kv-value ($\Delta p=1$ bar) (L/min)	Inner Thread (inch)	Voltage	PP-H EPDM Code	PP-H FKM Code
3	8.0	4	G1/4	24V DC	199 166 000	199 166 005
4	4.0	5	G1/4	24V DC	199 166 001	199 166 006
5	3.0	6	G1/4	24V DC	199 166 002	199 166 007
3	10.0	4	G1/4	230V 50Hz \pm 10%	199 166 010	
4	5.0	5	G1/4	230V 50Hz \pm 10%	199 166 011	
5	4.5	6	G1/4	230V 50Hz \pm 10%	199 166 012	199 166 017

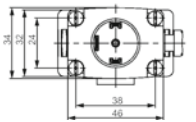
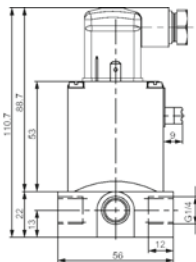
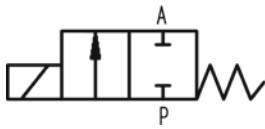

SYGEF Standard Solenoid valve type 166
Straight-through valve 2/2 ways

Model:

- Material: PVDF
- With manual override
- Electrical connection: cable plug
- Protection class IP 65
- Circuit function A: FC, closed in rest position

DN (mm)	PN (bar)	kv-value ($\Delta p=1$ bar) (L/min)	Inner Thread (inch)	Voltage	PN (bar)	PVDF FKM Code
3	8.0	4	G1/4	24V DC	0.0 - 8.0	199 166 505
4	4.0	5	G1/4	24V DC	0.0 - 4.0	199 166 506
5	3.0	6	G1/4	24V DC	0.0 - 3.0	199 166 507
5	4.5	6	G1/4	230V 50Hz \pm 10%	0.0 - 4.5	199 166 517

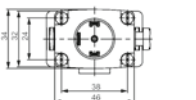
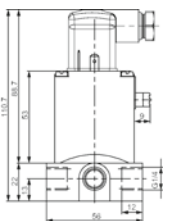
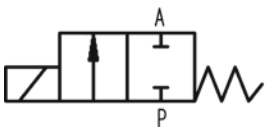



PROGEF Standard Solenoid valve type 166
Mixing valve 3/2 ways

Model:

- Material: PP-H
- With manual override
- Electrical connection: cable plug
- Protection class IP 65
- Circuit function E: In rest position, pressure connection P2 connected to outlet A. P1 closed

DN (mm)	PN (bar)	kv-value ($\Delta p=1$ bar) (L/min)	Inner Thread (inch)	Voltage	PN (bar)	PP-H EPDM Code	PP-H FKM Code
3	4	4	G1/4	24V AC/DC	0 - 4	199 166 150	
3	6	4	G1/4	230V 50Hz \pm 10%	0 - 6		199 166 165
4	2	5	G1/4	24V AC/DC	0 - 2	199 166 151	199 166 156

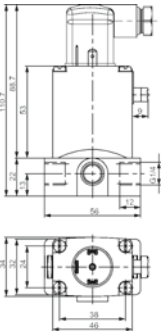
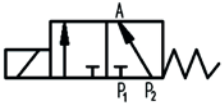

SYGEF Standard Solenoid valve type 166
Mixing valve 3/2 ways

Model:

- Material: PVDF
- With manual override
- Electrical connection: cable plug
- Protection class IP 65
- Circuit function E: In rest position, pressure connection P2 connected to outlet A. P1 closed

DN (mm)	PN (bar)	kv-value ($\Delta p=1$ bar) (L/min)	Inner Thread (inch)	Voltage	PN (bar)	PVDF FKM Code
4	2	5	G1/4	24V AC/DC	0 - 2	199 166 656
4	3	5	G1/4	230V 50Hz \pm 10%	0 - 3	199 166 666

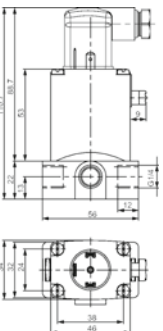
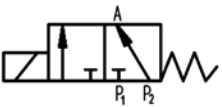



PROGEF Standard Solenoid valve type 166
Distribution valve 3/2 ways

Model:

- Material: PP-H
- With manual override
- Electrical connection: cable plug
- Protection class IP 65
- Circuit function F: In rest position, pressure connection P connected to outlet B. A closed

DN (mm)	PN (bar)	kv-value ($\Delta p=1$ bar) (L/min)	Inner Thread (inch)	Voltage	Function	EPDM Code	FKM Code
4	4	5	G1/4	24V AC/DC	F	199 166 201	199 166 206
4	4	5	G1/4	24V AC/DC	F	199 166 211	

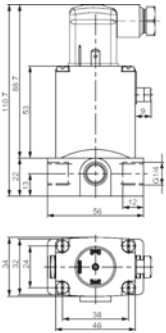
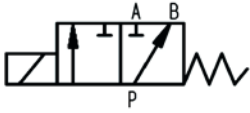

Pilot valves



Solenoid pilot valve type PV94 3/2-ways for single acting actuators

- For direct installation on single acting pneumatic actuators (FC/FO)
- Hollow screw
- Circuit function C: FC, closed in rest position
- Port A: G1/8 actuator connection
- Port P: compressed air
- Valve material: polyamid/brass
- IP 65 with socket connector
- Incl. reducer G 1/4 - G 1/8

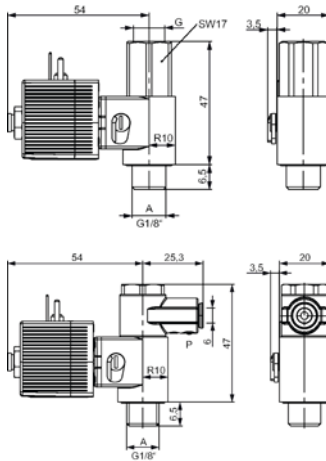

DN (mm)	PN (bar)	kv-value ($\Delta p=1$ bar) (l/min)	Port P	Voltage	Cable plug form	NBR Code	SP	Weight (kg)
1.2	10	48	G 1/8	24 V DC	C	199 190 498	1	0.172
1.2	10	48	G 1/8	24 V, 50-60 Hz	C	199 190 499	0	0.175
1.2	10	48	G 1/8	110 V, 50-60 Hz	C	199 190 500	0	0.117
1.2	10	48	G 1/8	230 V, 50-60 Hz	C	199 190 501	0	0.117
1.2	10	48	push-in 6mm	24 V DC	C	199 190 510	0	0.177
1.2	10	48	push-in 6mm	24 V, 50-60 Hz	C	199 190 511	0	0.180
1.2	10	48	push-in 6mm	110 V, 50-60 Hz	C	199 190 512	0	0.184
1.2	10	48	push-in 6mm	230 V, 50-60 Hz	C	199 190 513	0	0.178
1.2	10	48	NPT 1/8	24 V DC	C	199 190 546	0	0.118
1.2	10	48	NPT 1/8	110 V, 50-60 Hz	C	199 190 547	0	0.173
1.2	10	48	NPT 1/8	24 V AC	C	199 190 561	0	0.177
1.2	10	48	push-in 6mm	230 V, 50-60 Hz	B	199 190 571	1	0.133
1.2	10	48	G 1/8	230 V, 50-60 Hz	B	199 190 572	1	0.126
1.2	10	48	push-in 6mm	24 V DC	B	199 190 573	1	0.130
1.2	10	48	G 1/8	24 V DC	B	199 190 574	1	0.187



Solenoid pilot valve type PV95 3/2-ways for single acting actuators

- For direct installation on single acting pneumatic actuators (FC/FO)
- Hollow screw
- Circuit function C: FC, closed in rest position
- Port A: actuator connection
- Port P: compressed air
- Power consumption: 24VA at AC inrush; 17VA/8W at AC hold; 8W at DC
- Connector plug form A
- Valve material: polyamid/brass
- IP 65 with socket connector

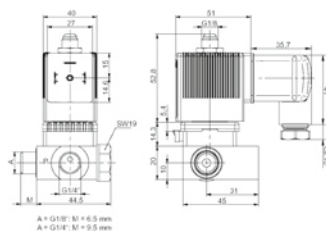

DN (mm)	PN (bar)	kv-value ($\Delta p=1$ bar) (l/min)	Port P	Port A	Voltage	FKM Code	SP	Weight (kg)
2	10	120	G 1/4	G 1/8	24 V DC	199 190 532	1	0.479
2	10	120	G 1/4	G 1/8	24 V, 50-60 Hz	199 190 533	1	0.406
2	10	120	G 1/4	G 1/8	110 V, 50-60 Hz	199 190 534	1	0.473
2	10	120	G 1/4	G 1/8	230 V, 50-60 Hz	199 190 535	1	0.435
2	10	120	NPT 1/8	G 1/4	24 V DC	199 190 554	1	0.487
2	10	120	NPT 1/8	G 1/4	110 V, 50-60 Hz	199 190 555	1	0.409



Solenoid pilot valve type PV2000 (1)
2 x 3/2-way valve

- Version for 3/2-way valves
- Electrical control over multiple and field bus connector

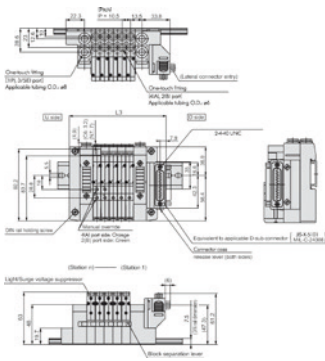

No	Voltage	Code	SP	Weight (kg)
1	24V/DC 100%	199 190 435	0	0.114



Solenoid pilot valve type PV2000 (2)
1 x 5/2-way valve

- Version for 5/2-way valves
- Electrical control over multiple and field bus connector

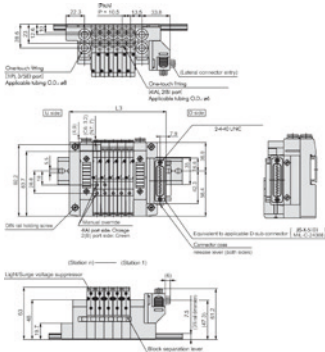

No	Voltage	Code	SP	Weight (kg)
2	24 V/DC 100%	199 190 436	0	0.105

Spare parts solenoid valves

Type 157

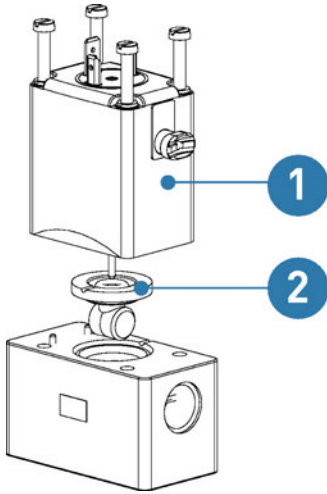

Coil set (1)
For solenoid valve type 157

Voltage	Function	EPDM Code	FKM Code
24V DC	A		198 808 006
24V UC	A	198 808 002	
230V AC	A	198 808 004	

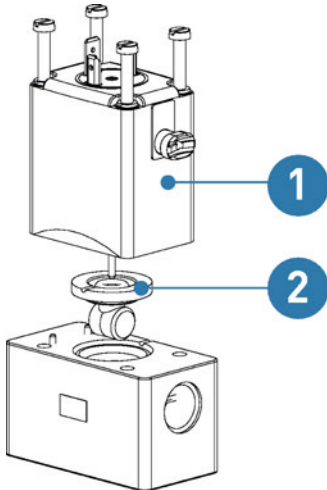

Wear part set (2)
For solenoid valve type 157

e.g. diaphragm

EPDM Code	FKM Code
198 808 012	198 808 013

Type 160/161



Coil set (1)
For solenoid valve type 160/161

24V UC Code	230 V UC Code	230 V/ 50Hz Code
198 808 014	198 808 015	198 808 016



Actuator Set (2)
For solenoid valve type 160/161

Model:

- Including core and pressure spring

Function	UC Code	50Hz Code
A	198 808 017	198 808 021
B	198 808 018	
E	198 808 019	
F	198 808 020	198 808 022

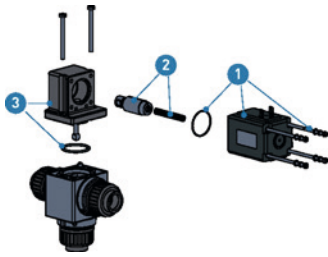

Wear part set (3)
For solenoid valve type 160/161

Model:

- Pre-assembled set with angle flange
- Set already pre-lubricated
- Manual override included

d (mm)	DN (mm)	EPDM Code	FKM Code
16	10	198 808 023	198 808 026
20	15	198 808 024	198 808 027
25	20	198 808 025	198 808 028

Type 165

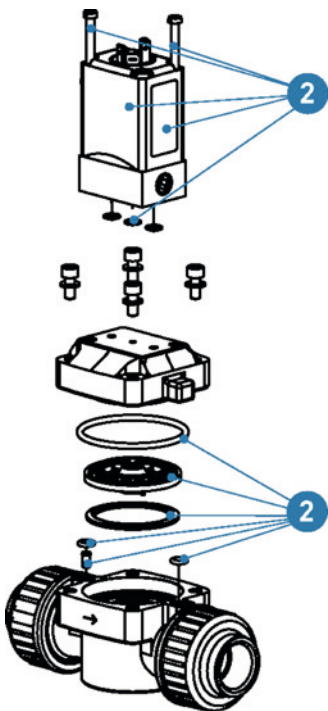

Coil set (1)
For solenoid valve type 165

Voltage	EPDM Code	FKM Code
24V DC	198 808 029	198 808 032
230V AC	198 808 030	198 808 033
110V AC	198 808 031	198 808 034

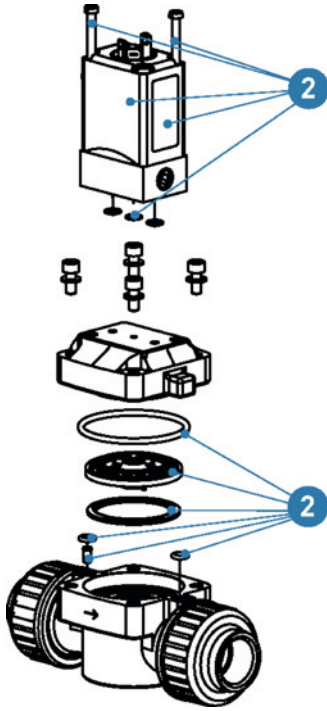

Wear part set (2)
For solenoid valve type 165

d-d (mm)	DN-DN (mm)	EPDM Code	FKM Code
20 - 25	15 - 20	198 808 035	198 808 038
32 - 40	25 - 32	198 808 036	198 808 039
50 - 63	40 - 50	198 808 037	198 808 040

Type 166

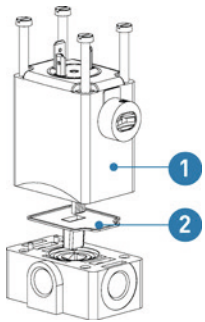

Coil set (1)
For solenoid valve type 166

Function	Voltage	FKM Code
C	24V UC	198 808 049

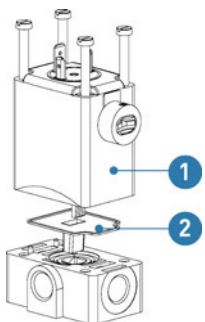

Wear part set (2)
For solenoid valve type 166

e.g. diaphragm

EPDM Code	FKM Code
198 808 053	198 808 054

Accessories



Cable plug For solenoid pilot valves type PV94 & 5470

Model:

- Cable plug according to DIN EN 175301 - 8203 (DIN 43 650)

Cable plug form	Voltage	Version	NBR Code	SP	Weight (kg)
B	0-250 V	no circuitry	199 190 578	1	0.048
B	0-24 V	with LED	199 190 579	1	0.020
B	0-250 V	with LED	199 190 580	1	0.020
B	0-24 V	with rectifier LED	199 190 581	1	0.020
C	0-250 V	no circuitry	199 190 518	0	0.010
C	0-24 V	with LED	199 190 519	0	0.015
C	0-24 V	with LED and varistor	199 190 520	0	0.015
C	0-24 V	with rectifier LED and varistor	199 190 521	0	0.020
C	200-240 V	with LED	199 190 522	0	0.020
C	200-240 V	with LED and varistor	199 190 523	0	0.020



Cable plug For solenoid pilot valves type PV95

Model:

- Cable plug according to DIN EN 175301-803 (DIN 43 650) form A

Voltage	Version	NBR Code	SP	Weight (kg)
0-250 V	no circuitry	199 190 540	1	0.030
0-24 V	with LED	199 190 541	1	0.020
0-24 V	with LED and varistor	199 190 542	1	0.020
0-24 V	with rectifier LED and varistor	199 190 543	1	0.020
200-240 V	with LED	199 190 544	1	0.020
200-240 V	with LED and varistor	199 190 545	1	0.020



Connection module profibus (1)
Solenoid pilot valve type PV2000

- Version for 3/2-way and 5/2-way valves

No	Code	SP	Weight (kg)
1	199 190 431	0	0.200



Connection module with bus interface (2)
For solenoid pilot valve type PV2000

No	Code	SP	Weight (kg)
2	199 190 425	0	0.156



Connection module AS-interface (1)
For solenoid pilot valve type PV2000

No	Code	SP	Weight (kg)
1	199 190 430	0	0.200



Connection module with D-sub connector (3)
For solenoid pilot valve type PV2000

No	Code	SP	Weight (kg)
3	199 190 424	0	0.198



End module (4)
For solenoid pilot valve type PV2000

No	Code	SP	Weight (kg)
4	199 190 426	0	0.148

**Silencer with plug connection 8 mm
For Solenoid pilot valve type PV2000**

Code	SP	Weight (kg)
199 190 427	0	0.005

**Plug (white)
For Solenoid pilot valve type PV2000**

d (mm)	Code	SP	Weight (kg)
8	199 190 428	1	0.005
6	199 190 429	0	0.010

**D-Sub connector 25 poles with connection cable
For Solenoid pilot valve type PV2000**

Cable length (m)	Code	SP	Weight (kg)
2	199 190 432	0	0.316
3	199 190 433	0	0.500
5	199 190 434	0	0.500

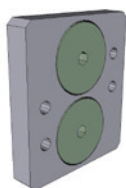

**NAMUR connector plate
for pilot valves type 5470 and type MNL532/ DIASTAR
DN15-50/ PA11/21 and PA30-55**

- PA30 - PA55 FC/FO, PA30 - PA65 DA

DN (mm)	Pos	Series PA11/21 Code	SP	Weight (kg)	Series PA30-55 Code	SP	Weight (kg)
15	2	199 190 378	1	0.054	199 190 275	1	0.114
20	2	199 190 378	1	0.054	199 190 275	1	0.114
25	2	199 190 378	1	0.054	199 190 275	1	0.114
32	2	199 190 378	1	0.054	199 190 275	1	0.114
40	2	199 190 378	1	0.054	199 190 275	1	0.114
50	2	199 190 378	1	0.054	199 190 275	1	0.114

Ten/028 FC Code	SP	Weight (kg)	Sixteen/Ten +/025 FC Code	SP	Weight (kg)	Ten/025 FO/DA Code	SP	Weight (kg)
199 190 378	1	0.054	199 190 378	1	0.054	199 190 378	1	0.054
199 190 378	1	0.054	199 190 378	1	0.054	199 190 378	1	0.054
199 190 378	1	0.054	199 190 378	1	0.054	199 190 378	1	0.054
199 190 378	1	0.054	199 190 379	1	0.354	199 190 378	1	0.054
199 190 379	1	0.354	199 190 379	1	0.354	199 190 379	1	0.354
199 190 379	1	0.354	199 190 379	1	0.354	199 190 379	1	0.354

Worldwide at home

Our sales companies and representatives ensure local customer support in more than 100 countries.

www.gfps.com

Argentina / Southern South America

Georg Fischer Central Plastics Sudamérica S.R.L.
Buenos Aires / Argentina
Phone +54 11 4512 02 90
gfccentral.ps.ar@georgfischer.com
www.gfps.com/ar

Australia

George Fischer Pty Ltd
Riverwood NSW 2210
Phone +61 (0) 2 9502 8000
australia.ps@georgfischer.com
www.gfps.com/au

Austria

Georg Fischer Rohrleitungssysteme GmbH
3130 Herzogenburg
Phone +43 (0) 2782 856 43-0
austria.ps@georgfischer.com
www.gfps.com/at

Belgium / Luxembourg

Georg Fischer NV/SA
1600 Sint-Pieters-Leeuw / Belgium
Phone +32 (0) 2 556 40 20
Fax +32 (0) 2 524 34 26
be.ps@georgfischer.com
www.gfps.com/be

Brazil

Georg Fischer Sist. de Tub. Ltda.
04571-020 São Paulo/SP
Phone +55 (0) 11 5525 1311
br.ps@georgfischer.com
www.gfps.com/br

Canada

Georg Fischer Piping Systems Ltd
Mississauga, ON L5T 2B2
Phone +1 (905) 670 8005
Fax +1 (905) 670 8513
ca.ps@georgfischer.com
www.gfps.com/ca

China

Georg Fischer Piping Systems Ltd
Shanghai 201319
Phone +86 21 3899 3899
china.ps@georgfischer.com
www.gfps.com/cn

Denmark / Iceland

Georg Fischer A/S
2630 Taastrup / Denmark
Phone +45 (0) 70 22 19 75
info.dk.ps@georgfischer.com
www.gfps.com/dk

Finland

Georg Fischer AB
01510 Vantaa
Phone +358 (0) 9 586 58 25
Fax +358 (0) 9 586 58 29
info.fi.ps@georgfischer.com
www.gfps.com/fin

France

Georg Fischer SAS
95932 Roissy Charles de Gaulle Cedex
Phone +33 (0) 1 41 84 68 84
fr.ps@georgfischer.com
www.gfps.com/fr

Germany

Georg Fischer GmbH
73095 Albershausen
Phone +49 (0) 7161 302 0
info.de.ps@georgfischer.com
www.gfps.com/de

India

Georg Fischer Piping Systems Pvt. Ltd
400 083 Mumbai
Phone +91 22 4007 2000
Fax +91 22 4007 2020
branchoffice@georgfischer.com
www.gfps.com/in

Indonesia

PT Georg Fischer Indonesia
Karawang 41371, Jawa Barat
Phone +62 267 432 044
Fax +62 267 431 857
indonesia.ps@georgfischer.com
www.gfps.com/id

Italy

Georg Fischer S.p.A.
20864 Agrate Brianza (MB)
Phone +39 02 921 86 1
Fax +39 02 921 86 24 7
it.ps@georgfischer.com
www.gfps.com/it

Japan

Georg Fischer Ltd
530-0003 Osaka
Phone +81 (0) 6 6341 2451
jp.ps@georgfischer.com
www.gfps.com/jp

Korea

Georg Fischer Korea Co. Ltd
Unit 2501, U-Tower
120 Heungdeok Jungang-ro
(Yeongdeok-dong)
Giheung-gu, Yongin-si, Gyeonggi-do
Phone +82 31 8017 1450
Fax +82 31 217 1454
kor.ps@georgfischer.com
www.gfps.com/kr

Malaysia

Georg Fischer (M) Sdn. Bhd.
41200 Klang, Selangor Darul Ehsan
Phone +60 (0) 3 3122 5585
Fax +60 (0) 3 3122 5575
my.ps@georgfischer.com
www.gfps.com/my

Mexico / Northern Latin America

Georg Fischer S.A. de C.V.
CP 66603 Apodaca, Nuevo León / Mexico
Phone +52 (81) 1340 8586
Fax +52 (81) 1522 8906
mx.ps@georgfischer.com
www.gfps.com/mx

Middle East

Georg Fischer Piping Systems (Switzerland) Ltd
Dubai / United Arab Emirates
Phone +971 4 289 49 60
gcc.ps@georgfischer.com
www.gfps.com/int

Netherlands

Georg Fischer N.V.
8161 PA Epe
Phone +31 (0) 578 678 222
nl.ps@georgfischer.com
www.gfps.com/nl

New Zealand

Georg Fischer Ltd
5018 Upper Hutt
Phone +04 527 9813
Fax +04 527 9834
nz.ps@georgfischer.com
www.gfps.com/nz

Norway

Georg Fischer AS
1351 Rud
Phone +47 67 18 29 00
no.ps@georgfischer.com
www.gfps.com/no

Philippines

George Fischer Pte. Ltd.
Philippines Representative Office
1500 San Juan City
Phone +632 571 2365
Fax +632 571 2368
sgp.ps@georgfischer.com
www.gfps.com/sg

Poland

Georg Fischer Sp. z o.o.
05-090 Sekocin Nowy
Phone +48 (0) 22 31 31 0 50
poland.ps@georgfischer.com
www.gfps.com/pl

Romania

Georg Fischer Piping Systems (Switzerland) Ltd
020257 Bucharest - Sector 2
Phone +40 (0) 21 230 53 80
ro.ps@georgfischer.com
www.gfps.com/int

Russia

Georg Fischer Piping Systems (Switzerland) Ltd
Moscow 125040
Phone +7 495 748 11 44
ru.ps@georgfischer.com
www.gfps.com/ru

Singapore

George Fischer Pte Ltd
528 872 Singapore
Phone +65 6747 0611
Fax +65 6747 0577
sgp.ps@georgfischer.com
www.gfps.com/sg

Spain / Portugal

Georg Fischer S.A.
28046 Madrid / Spain
Phone +34 (0) 91 781 98 90
es.ps@georgfischer.com
www.gfps.com/es

Sweden

Georg Fischer AB
117 43 Stockholm
Phone +46 (0) 8 506 775 00
info.se.ps@georgfischer.com
www.gfps.com/se

Switzerland

Georg Fischer Rohrleitungssysteme (Schweiz) AG
8201 Schaffhausen
Phone +41 (0) 52 631 3026
ch.ps@georgfischer.com
www.gfps.com/ch

Taiwan

Georg Fischer Co. Ltd
San Chung Dist., New Taipei City
Phone +886 2 8512 2822
Fax +886 2 8512 2823
www.gfps.com/tw

United Kingdom / Ireland

George Fischer Sales Limited
Coventry, CV2 2ST / United Kingdom
Phone +44 (0) 2476 535 535
uk.ps@georgfischer.com
www.gfps.com/uk

USA / Caribbean

Georg Fischer LLC
92618 Irvine, CA / USA
Phone +1 714 731 8800
Fax +1 714 731 6201
us.ps@georgfischer.com
www.gfps.com/us

Vietnam

Georg Fischer Pte Ltd
Representative Office
Ho Chi Minh City
Phone +84 28 3948 4000
Fax +84 28 3948 4010
sgp.ps@georgfischer.com
www.gfps.com/vn

International

Georg Fischer Piping Systems (Switzerland) Ltd
8201 Schaffhausen / Switzerland
Phone +41 (0) 52 631 3003
Fax +41 (0) 52 631 2893
info.export@georgfischer.com
www.gfps.com/int

The information and technical data (altogether "Data") herein are not binding, unless explicitly confirmed in writing. The Data neither constitutes any expressed, implied or warranted characteristics, nor guaranteed properties or a guaranteed durability. All Data is subject to modification. The General Terms and Conditions of Sale of Georg Fischer Piping Systems apply.