

# FLOWLINE



## Model: LI55 DataView™ Level Controller Quick Start



### Welcome to the LI55 Quick Start

The LI55 Quick Start demonstrates the more common level solution setups with the LI55. If you run into an issue that is not addressed in this quick start or wish to set up with a non-standard configuration, please address the LI55 Manual at [www.flowline.com](http://www.flowline.com)

**FLOWLINE**  
[www.flowline.com](http://www.flowline.com)

10500 Humbolt St. • Los Alamitos CA 90720 USA  
Tel (562) 598-3015 • Fax (562) 431-8507

## Disclaimer

The information contained in this document is subject to change without notice. Flowline makes no representations or warranties with respect to the contents hereof and specifically disclaims any implied warranties of merchantability or fitness for a particular purpose.



**CAUTION:** *Read complete instructions prior to installation and operation of the meter.*



**WARNING:** *Risk of electric shock or personal injury.*



**Warning!**

*This product is not recommended for life support applications or applications where malfunctioning could result in personal injury or property loss. Anyone using this product for such applications does so at his/her own risk. Flowline, Inc. shall not be held liable for damages resulting from such improper use.*

## Limited Warranty

Flowline, Inc. warrants this product against defects in material or workmanship for the specified period under “Specifications” from the date of shipment from the factory. Flowline’s liability under this limited warranty shall not exceed the purchase value, repair, or replacement of the defective unit.

## Registered Trademarks

All trademarks mentioned in this document are the property of its respective owners.

© 2012 Flowline, Inc. All rights reserved.

**[www.flowline.com](http://www.flowline.com)**

## We Do Your Level Best

Thank you for purchasing the DataView™ Analog Input Display (LI55). The LI55 Series is a multipurpose, easy to use digital process meter ideal for level applications. It accepts current signals (4-20 mA) and has four front panel buttons for configuration of the display.

A fully loaded LI55 Series meter has the following: four SPDT relays, 4-20 mA output, and two 24 VDC power supplies. The four relays can be used for alarm indication or process control applications, such as pump alternation control. The 4-20 mA isolated output, and digital I/O options make the LI55 Series an excellent addition to any system.

## Ordering Information

### Standard Models

85-265 VAC Model	12/24 VDC Model	Options Installed
LI55-1001	LI55-8001	No options
LI55-1201	LI55-8201	2 relays (LI56-1201*)
LI55-1011	LI55-8011	4-20 mA output (LI56-1011*)
LI55-1401	LI55-8401	4 relays (LI56-1401*)
LI55-1211	LI55-8211	2 relays & 4-20 mA output (LI56-1211*)
LI55-1411	LI55-8411	4 relays & 4-20 mA output (LI56-1411*)
*Model number for replacement option card.		

### Accessories

Model	Description
LI56-1400	4 SPST (Form A) relays
LI56-1000	Meter copy cable
LM91-1001	Single Display NEMA 4X Enclosure
LM91-2001	Dual Display NEMA 4X Enclosure

## Installing the DataView™

For most users, installation can be done without opening the case. It will only require opening when changing from a mA to voltage configuration (refer to the full manual found on-line at [www.flowline.com](http://www.flowline.com)).

When unpacking the DataView, thoroughly inspect the unit for any damage that may have occurred during shipping. Be sure to report any damage, as well as any missing parts or malfunctions to your supplier or Flowline.

## Mounting the Panel

- When mounting the panel, first prepare a standard 1/8 DIN panel cutout – 3.622" x 1.772" (92 mm x 45 mm), as shown below.
- Allow at least 6.0" (152 mm) clearance behind the panel for wiring.
- Be sure to maintain a minimum panel thickness of 0.04" - 0.25" (1.0 mm - 6.4 mm) to maintain Type 4X rating. This would equal 0.06" (1.5 mm) for a steel panel and 0.16" (4.1 mm) plastic panel.
- Remove the DataView's two mounting brackets. Back-off the two screws so that there is ¼" (6.4 mm) or less through the bracket. Slide the bracket toward the front of the case and remove.
- Insert the DataView into the panel cutout.
- Install mounting brackets and tighten the screws against the panel. To achieve a proper seal, tighten the mounting bracket screws evenly until meter is snug to the panel along its short side. **DO NOT OVER TIGHTEN**, as the rear of the panel may be damaged.

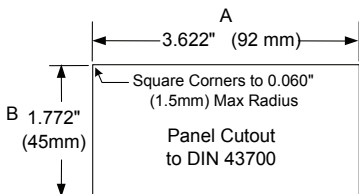

Tolerances:

A: +0.032 (+0.8mm)  
-0.000 (-0.0mm)

B: +0.024 (+0.6mm)  
-0.000 (-0.0mm)

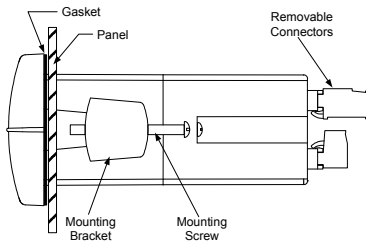

DataView Panel Cutout 1/8 DIN

DataView Mounting Specs

## Configuration for 12 or 24 VDC Power

The DataView allows for either a 12 or 24 VDC power option and comes shipped from the factory ready to operate from 24 VDC. DO NOT exceed these voltage ratings for the DataView.

### To configure the DataView for 12 VDC power:

1. Remove all the connectors.
2. Unscrew the back cover.
3. Slide the back cover about 1 inch to expose the board.
4. Configure the J9 jumper behind the power connector for the desired power configuration as shown below.

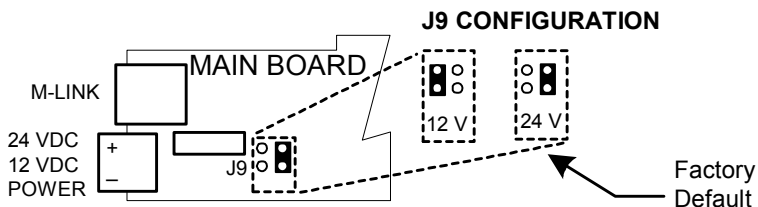

**DataView Power Jumper Settings**  
(Applies to LI55-8\_\_1 version only)

## Transmitter Supply Voltage Selection (P+, P-)

All DataView models come shipped from the factory configured to provide 24 VDC power for the transmitter or sensor. If the installation's transmitter requires 5 or 10 VDC excitation, the internal jumper J4 must be configured accordingly.

### To access the voltage selection jumper:

1. Remove all the wiring connectors.
2. Unscrew the back cover.
3. Slide out the back cover by about 1 inch.
4. Configure the J4 jumper, located behind the input signal connector, for the desired excitation voltage as shown.

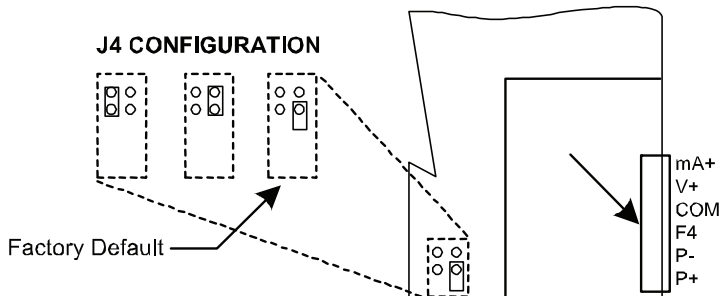

**Transmitter Supply Voltage Selection**  
**(Do not change if using a Flowline 4-20 mA transmitter)**

## Connections

All connections are made by attaching wires onto removable screw terminal connectors located at the rear of the DataView.

Copper wire with 60°C or 60/75°C insulation should be used for all line voltage connections, observing all safety regulations. Electrical wiring should be performed in accordance with all applicable national, state, and local codes to prevent damage to the meter and ensure personnel safety.

The connectors' label shows the function of each of the connections, such as POWER, RELAY, SIGNAL, etc. The RJ-45 M-LINK connection is intended for Flowline expansion modules, cables, or meters ONLY. Any other use of the DataView's RJ-45 connection may damage the DataView and any equipment connected thereto. The different types of connections are explained on the following pages.

DO NOT connect any equipment other than Flowline's expansion modules, cables, or meters to the RJ45 M-LINK connector. Otherwise damage will occur to the equipment and the meter.

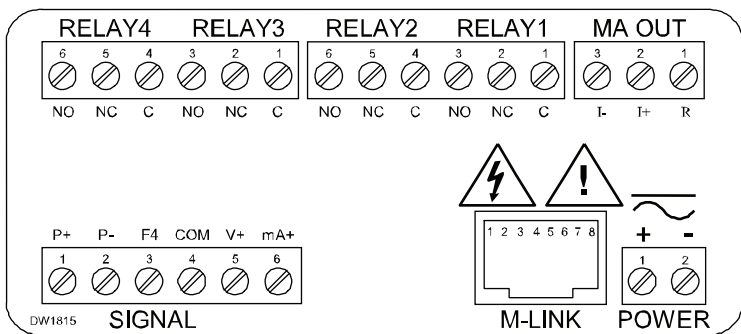

**DataView Connections Labeled**

## Power Connections

The external power source to DataView is connected through a two-terminal connector labeled POWER. The DataView will operate regardless of polarity connection. The + and - symbols are only a suggested wiring convention.

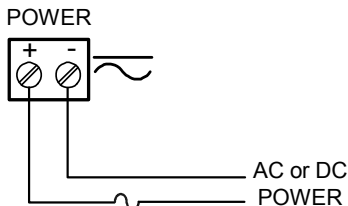

Required External Fuse:  
5 A max, 250 V Slow Blow

### DataView Power Connection



*Refer to the product label on the display for the DataView's power requirements.*

- The LI55-1\_\_1 series operates from 95 to 265 VDC, 5-60 Hz.
- The LI55-8\_\_1 series operates at 12 to 24 VDC.

## Signal Connections

Signal connections are made to a six-terminal connector labeled SIGNAL. The COM (common) terminal is the return for the 4-20 mA and the  $\pm 10$  V input signals.



*The 2-wire connection is the most common for Flowline products (EchoPod, EchoSonic II, EchoSpan, EchoSafe, Echotouch (LU20 series only), DeltaSpan and FloaTek series).*



### Wiring for Current Inputs

The following figures show examples of current and voltage connections. There are no switches or jumpers to set up for current and voltage inputs. Setup and programming is performed through the front panel buttons.

#### Most common wiring

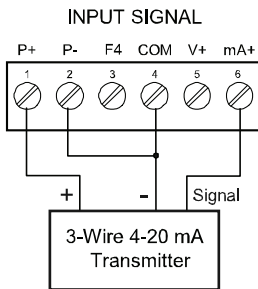
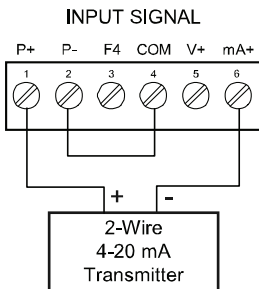

**DataView 2-Wire Transmitter Connection**

**DataView 3-Wire Transmitter Connection**

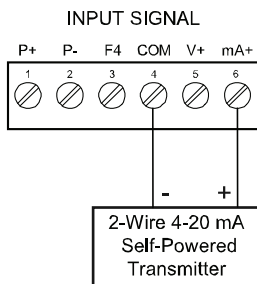
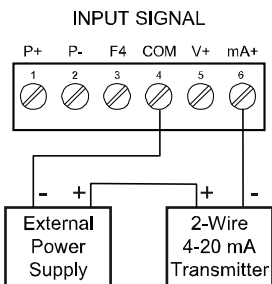

**DataView Externally-Powered Transmitter Connection**

**DataView Self-Powered Transmitter Connection**

The current input is protected against current overload by a resettable fuse. The display may or may not show a fault condition depending on the nature of the overload. The fuse limits the current to a safe level when it detects a fault condition, and automatically resets itself when the fault condition is removed.

## Wiring for Current and Voltage Inputs

The figures shown below are examples of voltage connections. See the section 'Transmitter Supply Voltage Selection' for possible jumper setting with voltage connections. Current reception is protected against overload by a resettable fuse. The display may or may not show a fault condition depending on the nature of the overload. The fuse limits the current to a safe level when it detects a fault condition, and automatically resets itself when the fault condition is removed. The DataView is capable of receiving any voltage ranging from -10 VDC to +10 VDC.

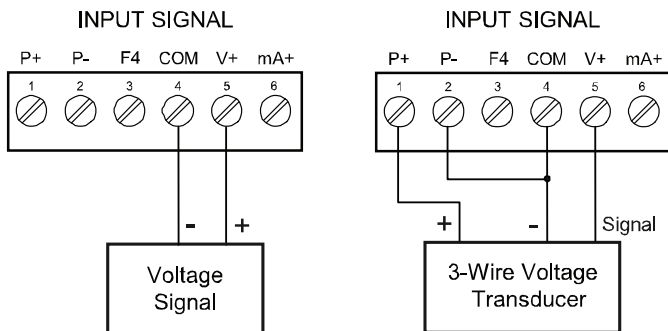

**DataView Voltage Input Connections**

## Relay Connections

Relay connections are made through two six-terminal connectors labeled RELAY1 – RELAY4. Each relay's "C" terminal is common only to the normally open ("NO") and normally closed ("NC") contacts of the corresponding relay. The relays' "C" terminals should not be confused with the COM (common) terminal of the INPUT SIGNAL connector.

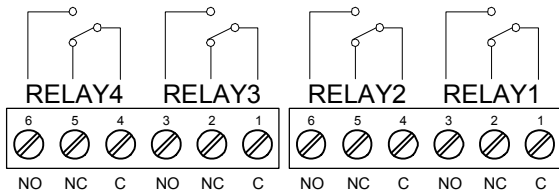

**DataView Relay Connections**

## Switching Inductive Loads

Suppressors (snubbers) prevent microprocessor disruption and prolong the life of the relay contacts and should always be employed. Suppression can be obtained with resistor-capacitor (RC) networks assembled by the user or purchased as complete assemblies. This section is provided to assist you with suppressor assembly and installation.

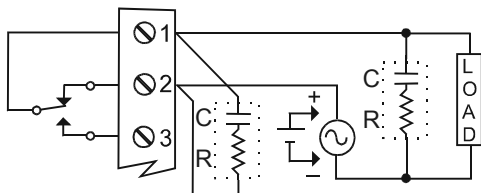

### AC and DC Loads Protection

Choose R and C as follows:

R: 0.5 to 1  $\Omega$  for each volt across the contacts

C: 0.5 to 1  $\mu\text{F}$  for each amp through closed contacts

When using suppressors, please keep in mind:

1. Use capacitors rated for 250 VAC.
2. Confirm proper operation. RC networks may affect load release time of solenoid loads.
3. Install the RC network on the DataView's relay screw terminals. An RC network may also be installed across the load.
4. Use a diode with a reverse breakdown voltage two to three times the circuit voltage and forward current at least as large as the load current.

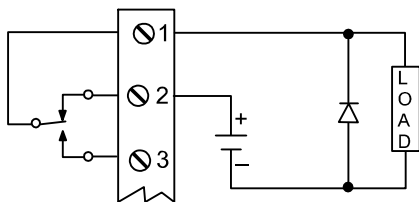

### Low Voltage DC Loads Protection

**Note:** Relays are de-rated to 1/14th HP (50 watts) with an inductive load.

### Repeater Output Wiring (4-20 mA Output Connections)

Connections for the 4-20 mA transmitter output to transmitters or other devices are made to the connector terminals labeled MA OUT. The 4-20 mA output may be powered internally or from an external power supply.

- **Internal Power** - The DataView provides an internal 24 VDC, 40 mA power supply that can be used to power the repeater loop if required (follow the illustration below on the left). This circuit will provide the excited 4-20 mA signal from the display to any device that will accept the 4-20 mA signal.
- **External Power** - This circuit requires a separate VDC power supply be used to power the repeater loop (follow the illustration below on the right). This circuit will provide a passive 4-20 mA signal from the display to any device that will accept a 4-20 mA signal.

**Note:** you will not see a 4-20 mA signal unless the external power supply is added to the loop.

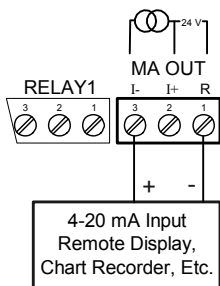

**DataView Repeater Output  
Internal Power Wiring**

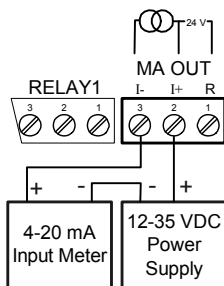

**DataView Repeater Output  
External Power Wiring**

### Analog Output Transmitter Power Supply

The internal 24 VDC power supply powering the analog output may be used to power other devices, if the analog output is not available. The DataView's "I+" terminal is the +24 V and the "R" terminal is the return. This power supply is capable of sourcing up to 40 mA.

## The DataView Interface

The DataView is factory calibrated to read 4-20 mA inputs. The calibration equipment is certified to NIST standards.

### Overview

There are no jumpers to set for the meter input selection. All setup and configuration are performed through the front panel interface. After power and input signal connections have been completed and verified, apply power to the meter.

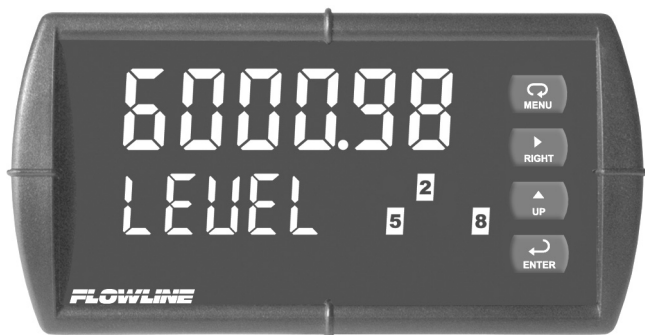





## Front Panel Operation

### *Display (Two-Line Display)*

- The top line displays the level or volume of the tank.
- The bottom line displays the units for the level or volume of the tank.
  - The DataView has 7 preset units [Gallons (*GAL*), Liters (*LITER*), Inches (*inch*), Feet (*FEET*), Centimeters (*cm*), Meters (*METER*) and Percent (*PERCENT*)] and a custom function [*Custom (CUSTOM)*] to configure any other set of units up to 6-alphanumeric characters.
- Alarm indicators 1-8.
  - Indicators 1-4 are enabled by default.
  - When a relay expansion card (LI56-1400) is installed, indicators 5-8 become available.

## Buttons

Down the right side of the Dataview's front panel are four buttons. It is through these buttons that you will set up and configure the DataView. These buttons are explained as follows:

	<p><b>Menu</b> Use this button to enter or exit the DataView's configuration mode, view settings, or access advanced features.</p>
	<p><b>Right</b> Use this button to move to the next digit during digit or decimal point configuration. This is also used to reset the max/min readings or other parameter/function assigned through the User menu.</p>
	<p><b>Up</b> Use this button to scroll through the menus, decimal point, or to change the value of a digit. This is also used to display max/min readings or other parameter/function assigned through the User menu.</p>
	<p><b>Enter</b> Use this button to access a menu or to accept a setting. Configuration changes are only saved after this is pressed. This is also used to acknowledge relays or other parameters/function assigned through the User menu.</p>

### A Note on Characters

0 123456789AbCdEFGHh I JH  
LnOpQrStUvWxYz- / = [ ] ^ \_ ` °

The DataView display uses a graphic system to type out each command. While the letters "m" and "w" are not included, they can be created by combining characters.

n + 7 = n7

u + j = uj

## Setup and Configuration

This section will take you through the 6 key steps in setting up and programming the DataView (some configurations of DataView will not use all 6 steps).

- 1. Select and set Units of operation (unitS)**
  - a. This step determines the units of operation for the display.
  - b. The value that appears on the display will reflect the choice of units.
  - c. The actual units can be configured to appear in the lower display (LI55LE).
- 2. Setting the decimal point (dEc Pt)**
  - a. This step determines the location of the decimal point.
  - b. For example, you can configure the display to read to 1/10th position, 1/100th position, 1/1000th position, etc.
- 3. Setting the SCALE function (SCALE)**
  - a. This step configures the display to read in the actual units of operation.
- 4. Setting the Relay(s) (rELAY)**
  - a. This step configures the relays and where they will energize and de-energize.
  - b. This step is only available with configurations that include relays: (LI55-\_201, LI55-\_211, LI55-\_401 or LI55-\_411).
- 5. Setting the Analog Output (Aout)**
  - a. This step configures the analog output for the display.
  - b. The step is only available with configurations that include the repeater output (LI55-\_011, LI55-\_211 & LI55-\_411).
- 6. Password (Pass 1)**
  - a. Sets a protective password to secure the settings for the display.



### Main Menu Overview

The Main Menu contains all of the most commonly used features of the DataView meter.

- Press Menu button to enter the main menu then press the Up arrow button to scroll main menu.

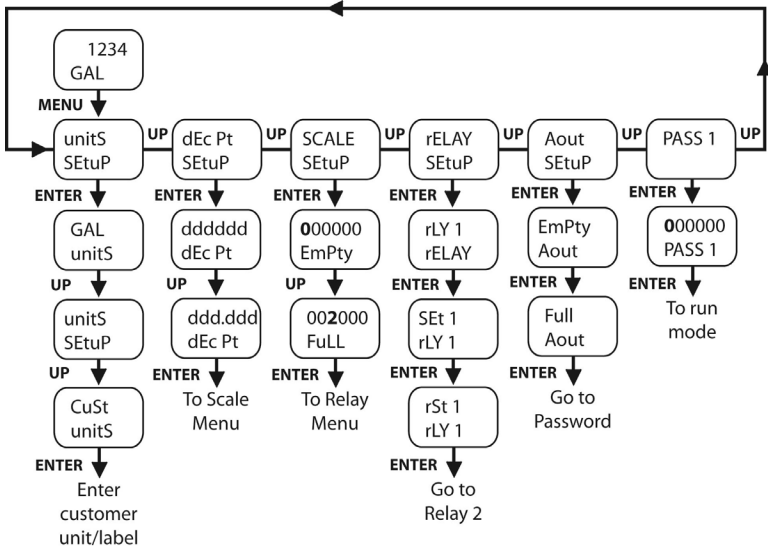

- Press Menu, at any time, to exit and return to Run Mode. Changes made to settings prior to pressing Enter are not saved.
- Changes to the settings are saved to memory after pressing Enter.
- The display moves to the next menu every time a setting is accepted by pressing Enter.

## Main Menu

To enter Dataview's Main Configuration menu, press the MENU button. With the UP arrow, you can scroll through six menu options: Units (units), Decimal Point (dEc Pt), Scale (SCALE), Relay (rELAY), Analog Output (Aout) and Password (PASS 1). Each of these options is explained above.

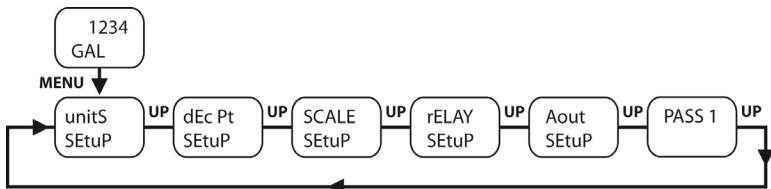

## Setting Numeric Values

The numeric values used in Scale, Relay and Analog Output are set using the Right and Up buttons. Press Right arrow to select next digit and Up arrow to increment digit value. The digit being changed is displayed brighter than the rest. Press and hold up arrow to auto-increment the display value. Press the Enter button, at any time, to accept a setting or Menu button to exit without saving changes.

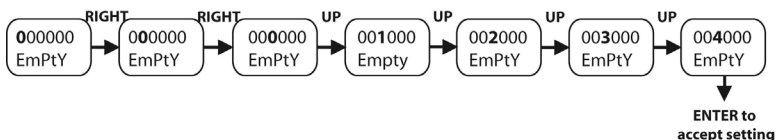

## Setting the Units of Operation (unitS)

The LI55 series can show level (ex. InCHES, cm, FEET, Meter, etc) or Volume (GAL, LitErS, etc.) or any other engineering units. Please determine the units of operation that you want to appear on the display. The units chosen will not only represent the displayed values, but also the settings for the relay(s) and the repeater output.

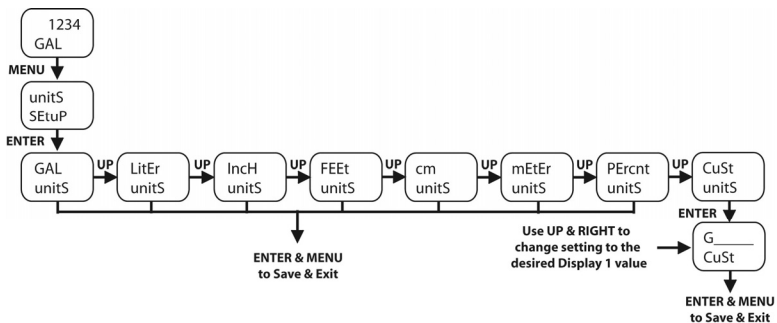

### To set units:

1. Press the **MENU** button to enter the Main Menu. Units (unitS) will be the first operation available.
2. Press **ENTER** button to enter Units. The current setting will appear.
3. Press the **Up** button to scroll through the options for Units.
  - a. Choices include Gallons (GAL), Liters (LitEr), Inches (InCH), Feet (FEET), Centimeters (cm), Meters (MEtEr), Percent (PERcnt) and Custom (CuSt).
4. When the correct unit of operation appears, press **ENTER** to save this setting and then press **MENU** to exit.
  - a. For custom (CuSt), press **ENTER** to proceed to the next screen.
  - b. Use the **UP** and **RIGHT** buttons to change each character to the desired set of alphanumeric characters.
  - c. See *A Note on Characters* on page 15 to review the options for the available alphanumeric characters.
  - d. There are 6 segments available for the Custom setting.
  - e. When completed, press **ENTER** to save this setting and then press **MENU** to exit.

## Setting the Decimal Point (*dEc Pt*)

The decimal point may be set to as many as five decimal places. Use the Decimal Point feature to position the decimal point for all values displayed. Placement of the decimal point can influence the displayed output of your process. For example, setting a scale of 0 to 100% can be shown in four different methods:

<b>Method #1</b>	0% to 100%	Reads to the ones place and is not very accurate.
<b>Method #2</b>	0.0% to 100.0%	Reads to the 1/10's place and provides good accuracy.
<b>Method #3</b>	0.00% to 100.00%	Reads to the 1/100's place. The accuracy is very good but may not be practical.
<b>Method #4</b>	0.000% to 100.000%	Reads to the 1/1000's place. This is highly accurate but may not be practical.

When selecting a decimal point, take into account the practical scale for reading the level of liquid.

### To set the decimal point:

1. Press the **MENU** button to bring up the Main Menu. Units (unitS) will be the first operation available.
2. Press the **Up** button to scroll through menu options until you reach Decimal Point (dEc Pt).
3. Press **ENTER** button to enter Decimal Point. The current setting will appear.
4. Press the **Right** button to move the decimal point from left to right.
  - a. **Note:** The decimal point may be set with up to five decimal places or with no decimal point at all. Pressing the Right arrow moves the decimal point one place to the right until no decimal point is displayed, and then it moves to the left most position.
5. When the decimal is set where you like, press **ENTER** button to save this setting.
6. Press **MENU** button to exit.

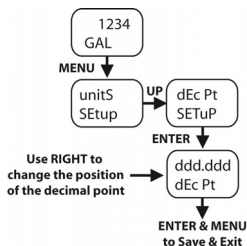

### Setting the SCALE Function (SCALE)

The DataView displays information about tank contents in engineering units. The display uses a two point linearization based upon Empty and Full settings.

**Although a signal source is not needed to scale the meter**, you will need to configure the sensor connected to the display to reflect a 4-20 mA current span between tank empty and tank full.

Enter the value you wish an Empty tank to show when empty and the value a Full tank to show when full. These are the corresponding Empty (EmPtY) and Full (FuLL) settings.

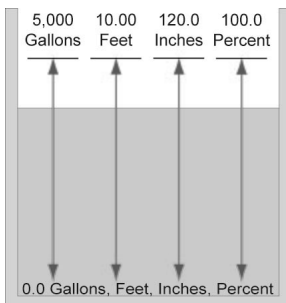

#### To set the SCALE function:

1. Press the **MENU** button to enter the Main Menu. Units (unitS) will be the first operation available.
2. Press the **Up** button to scroll through the menu options until you reach Scale (SCALE).
3. Press **ENTER** button to enter the Scale.
  - a. Empty (EmPtY) will appear.
4. Press the **ENTER** button to change the Empty value. This is typically the value seen when the tank is empty. Press the **Right** button to move the highlighted digit to the right and the **Up** button to increase the setting's value.
5. Press the **ENTER** button to save the settings.
  - a. Full (FuLL) will appear.
6. Press the **ENTER** button again to change Full value. This is typically the value seen when the tank is full. Press the **Right** button to move the highlighted digit to the right and the **Up** button to increase the setting's value.
7. Press the **ENTER** button again to save the settings.
8. Press the **MENU** button to exit.

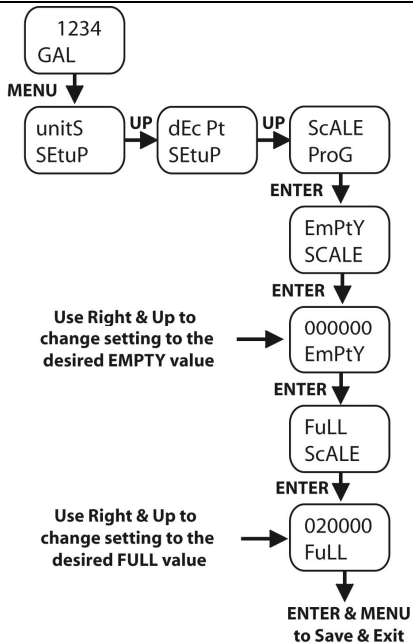

### Setting the Relay Display (*rELAy*)

This step sets when the relay will energize (SET#) and de-energize (RST#). See below for example of common relay configurations.

- Note:** All the settings are based on the units of liquid defined in the previous scale section. Never set the relay SET# or RST# at the Empty or Full settings. Ex: if the Scale is set from 0 to 100 gallons, then the relay settings will also be in gallons above 0 and below 100 gallons. The SET# should never be equal to 0 gallons or the RST# be equal to 100 gallons.

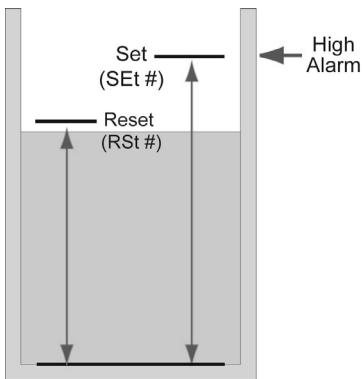

High Alarm

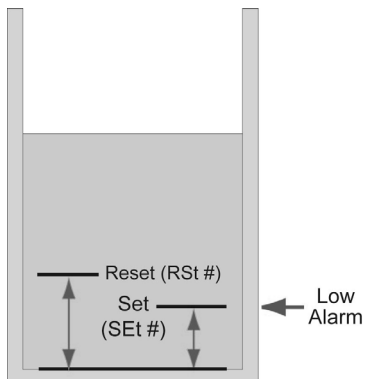

Low Alarm

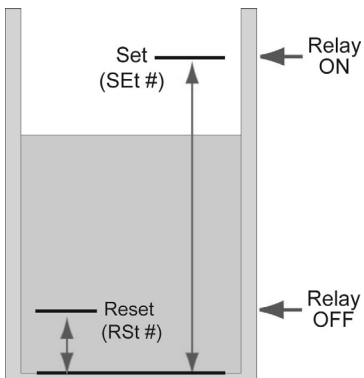

Automatic Empty

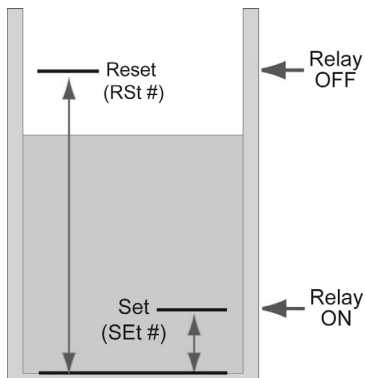

Automatic Fill

- For high level alarms, use the SET# to indicate the level setting where the relay will turn on and the RST# to indicate the level setting where the relay will turn off. **Note:** The RST# setting should be a lower setting than the SET#.
  - Increasing the RST# setting from the SET# setting will increase the hysteresis of the relay.
- For low level alarms, use the SET# to indicate the level setting where the relay will turn on and the RST# to indicate the level setting where the relay will turn off. **Note:** The RST# setting should be a higher setting than the SET#.
  - Increasing the RST# setting from the SET# setting will increase the hysteresis of the relay.
- For automatic fill or empty applications, use the SET# to indicate the ON level and RST# to indicate the OFF level.

**To set the relay(s):**

1. Press the **MENU** button to enter the Main Menu. Units (unitS) will be the first operation available.
2. Press the **Up** button to scroll through the menu options until you reach Relay (rELAY).
3. Press **ENTER** button to enter Relay. Relay 1 (rLY 1) will appear.

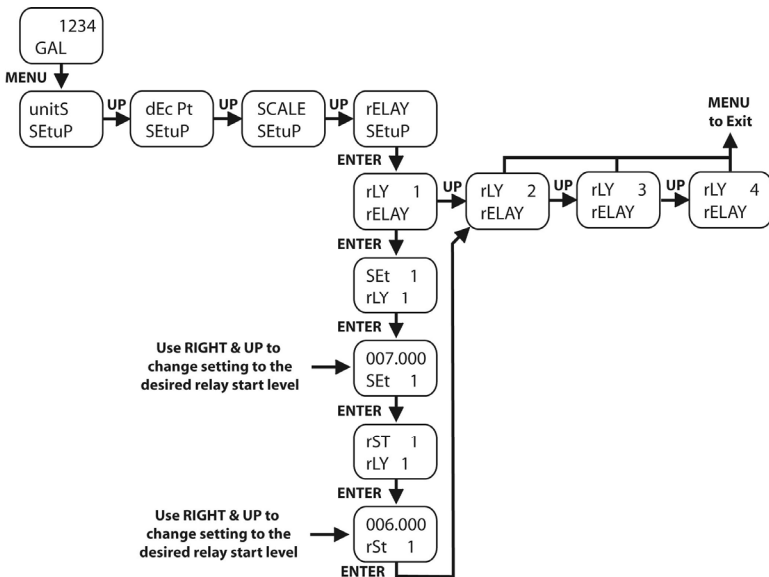



- a. Scroll through the Relays, usually 1-4, using the **Up** button. Press the **ENTER** button to select a Relay.
  - b. The Relay Set Point (SEt #) will appear.
4. Press the **ENTER** button again to view the Relay Set Point (SEt #) for the relay. The Relay Set Point sets the level where the relay will energize by falling between the Empty and Full values. Values can be changed by pressing the **Right** button to move the highlighted digit to the right and the **Up** button to increase the setting's value.
  - a. Press the **ENTER** button to save this setting.
  - b. The Relay Reset Point (rSt #) will appear.
5. Press the **ENTER** button again to view the Reset Point (rSt #) for the relay. The Reset Point sets level where the relay will de-energize by falling between the Empty and Full values. Again, values can be changed by pressing the **Right** button to move the highlighted digit to the right and the **Up** button to increase the setting's value.
  - a. Press the **ENTER** button to save the setting.
  - b. The next relay (rLy #) in sequence will appear
6. To set another relay, press **ENTER** to continue or press **MENU** button to exit.

### How to Configure the Repeater / Analog Output (*Aout*)

With an optional repeater output, you can transmit the 4-20 mA signal to another device, such as another display, a PLC, a chart recorder, etc. The repeater/analog output can be scaled in two ways:

1. Identical to the 4-20 mA input signal. This setup repeats the input current directly to your new device.
2. Scaled to a smaller span.
  - a. In instances where you are controlling an actuated valve or pump, this transmits the analog output for a specific range.

The Repeater/Analog output uses a 2-point linear configuration based upon an Empty and Full value setting.

- **Note:** The Analog Output (Aout) must always be configured. Leaving the Analog Output in the factory setting will most often result in strange values.
- Ex. Scale is setup with Empty = 000000 and Full = 005000. If the Aout has not been changed, then repeater output will have a different scaled output as the input. You must configure Aout to match the Scale's Empty and Full setting to repeat the correct 4-20 mA signal.

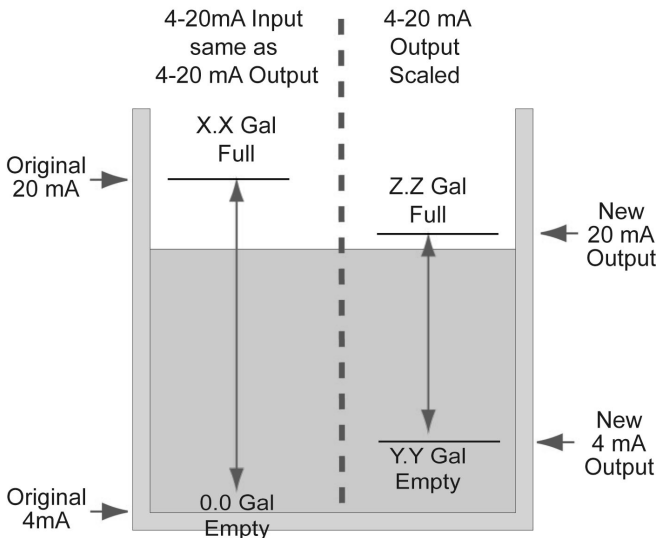

**To set the Repeater / Analog Output:**

**Note:** Before configuring the Analog Output, make sure the Scale has been completed.

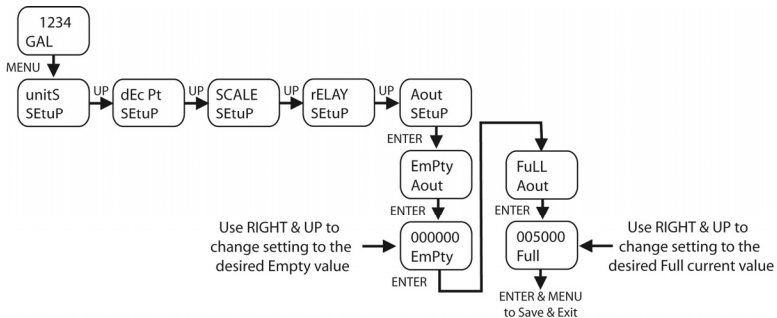

1. Press the **MENU** button to enter the Main Menu. Units (unitS) will be the first operation available.
2. Press the **Up** button to scroll through the menu options until you reach Analog Output (Aout).
3. Press **ENTER** button to enter Analog output. Empty (EmPTY) will appear.
4. Press the **ENTER** button to change the Empty value.
  - a. Press the Right button to move the highlighted digit to the right and the Up button to increase the setting's value.
5. Press **ENTER** button to save the settings.
  - a. Full (FuLL) will appear.
6. Press **ENTER** button to move the highlighted digit to the right and the Up button to increase the setting's value.
7. Press **ENTER** button again to save the settings.
8. Press the **MENU** button to exit.

## How to Set a Password (PASS 1)

The Password menu is used for programming a 6-digit password to prevent unauthorized changes to the programmed parameter settings. Record the password for future reference. If appropriate, it may be recorded in the space provided.

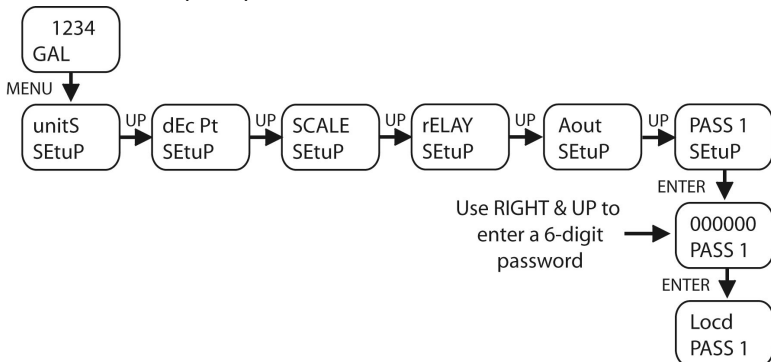

### To set the password:

1. Press the **MENU** button to enter the Main Menu. Units (unitS) will be the first operation available.
2. Press the **Up** button to scroll through the menu options until you reach Password (PASS 1).
3. Press ENTER button to enter a password. 000000 will appear.
  - a. Press the Right button to move the highlighted digit to the right and the Up button to increase the setting's value.
4. Press **ENTER** button to save Password.
  - a. Locked (Locd) will appear.

Record the password for future reference. If appropriate, it may be recorded in the space provided.

Model:	
Serial Number:	
Password:	__ _ _ _ _

## Making Changes to a Password Protected Meter

If the meter is password protected, the meter will display the message *Locd* (*Locked*) when the Menu button is pressed. Press the Enter button while the message is being displayed and enter the correct password to gain access to the menu. After exiting the programming mode, the meter returns to its password protected condition.

### Disabling Password Protection

To disable the password protection, access the *Password* menu and enter the correct password twice. The meter is now unprotected until a new password is entered.

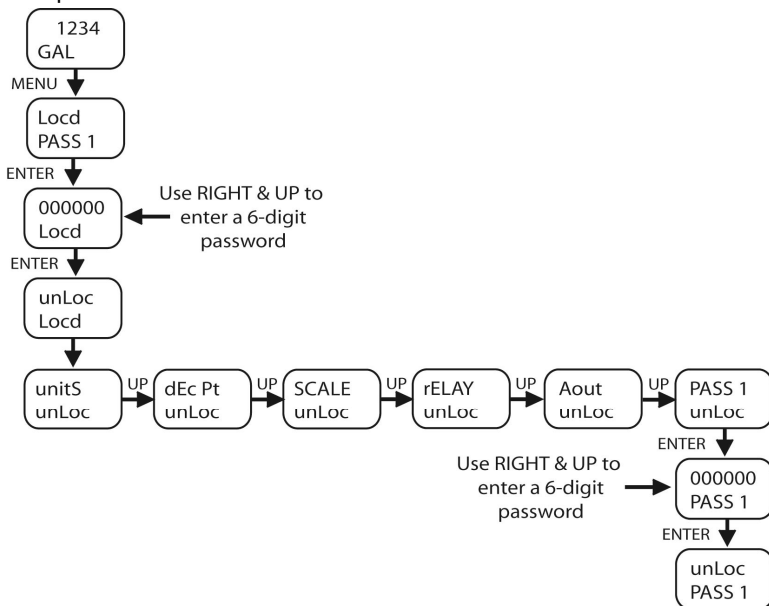

1. Press the **MENU** button to enter the Main Menu. Locked (*Locd*) will appear.
2. Press the **ENTER** button to enter a password. 000000 will appear.
  - a. Enter the correct password using the **Right** button to move the highlighted digit to the right and the **Up** button to increase the setting's value.
3. Press the **ENTER** button to enter the Password.
  - a. Unlocked (*unLoc*) will appear.

4. Press the **Up** button to scroll through the menu options until you reach Password (PASS 1).
5. Press the **ENTER** button to enter a password. 000000 will appear.
  - a. Enter the correct password again using the Right button to move the highlighted digit to the right and the Up button to increase the setting's value.
6. Press the **ENTER** button to save Password.
  - a. Unlocked (unLoc) will appear again and the password is disabled.

If the correct six-digit password is entered, the meter displays the message *unLoc* (*unlocked*) and the protection is disabled until a new password is programmed. If the password entered is incorrect, the meter displays the message *Locd* (*Locked*) for about two seconds, and then it returns to Run Mode. To try again, press Enter while the *Locked* message is displayed.

#### **Did you forget the password?**

The password may be disabled by entering a master password once. If you are authorized to make changes, enter the master password **508655** to unlock the meter.

## Reset Meter to Factory Defaults

When the parameters have been changed in a way that is difficult to determine what's happening, it might be better to start the setup process from the factory defaults.

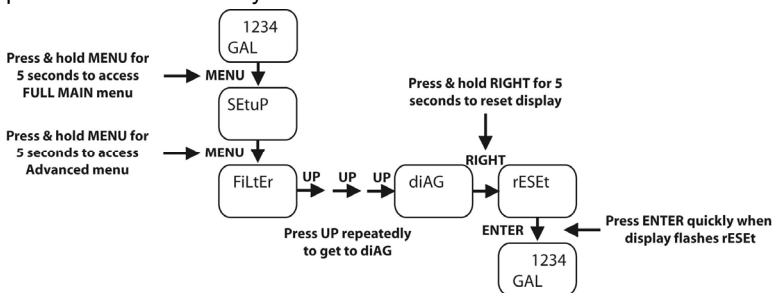

### Instructions to load factory defaults:

1. Press and hold **MENU** button for 5 seconds to enter the Full Main menu. *SEtUP* will appear on the display.
2. Press and hold **MENU** button again for 3 seconds to enter Advanced menu. *FiltEr* will appear on the display.
3. Press **Up** button to go to *diAG* (*Diagnostics* menu)
4. Press and hold **Right** button for three seconds, until *rESEt* appears. Press **ENTER** when display flashes *rESEt*.
  - a. Note: If **ENTER** is not pressed within three seconds, the display returns to the *Diagnostics* menu.
5. The meter goes through an initialization sequence (similar as on power-up), and loads the factory default settings.

***For complete product documentation, video training, and technical support, go to [www.flowline.com](http://www.flowline.com).***

***For phone support, call 562-598-3015 from 8am to 5pm PST, Mon - Fri.***

***(Please have the Part and Serial number available.)***

## **Warranty**

Flowline warrants to the original purchaser of its products that such products will be free from defects in material and workmanship under normal use and service in accordance with instructions furnished by Flowline for a period, which is equal to the shorter of one year from the date of purchase of such products or two years from the date of manufacture of such products. Flowline's obligation under this warranty is solely and exclusively limited to the repair or replacement, at Flowline's option, of the products or components, which Flowline's examination determines to its satisfaction to be defective in material or workmanship within the warranty period. Flowline must be notified pursuant to the instructions below of any claim under this warranty within thirty (30) days of any claimed lack of conformity of the product. Any product repaired or replaced under this warranty will be warranted only for the remainder of the original warranty period.

## **Returns**

Products cannot be returned to Flowline without Flowline's prior authorization. To return a product that is thought to be defective, go to [www.flowline.com](http://www.flowline.com), and submit a customer return (MRA) request form and follow the instructions therein. All warranty and non-warranty product returns to Flowline must be shipped prepaid and insured. Flowline will not be responsible for any products lost or damaged in shipment.

## **Limitations**

This warranty does not apply to products which: 1) are beyond the warranty period or are products for which the original purchaser does not follow the warranty procedures outlined above; 2) have been subjected to electrical, mechanical or chemical damage due to improper, accidental or negligent use; 3) have been modified or altered; 4) anyone other than service personnel authorized by Flowline have attempted to repair; 5) have been involved in accidents or natural disasters; or 6) are damaged during return shipment to Flowline. Flowline reserves the right to unilaterally waive this warranty and dispose of any product returned to Flowline where: 1) there is evidence of a potentially hazardous material present with the product; or 2) the product has remained unclaimed at Flowline for more than 30 days after Flowline has dutifully requested disposition. This warranty contains the sole express warranty made by Flowline in connection with its products. ALL IMPLIED WARRANTIES, INCLUDING WITHOUT LIMITATION, THE WARRANTIES OF MERCHANTABILITY AND FITNESS FOR A PARTICULAR PURPOSE, ARE EXPRESSLY DISCLAIMED. The remedies of repair or replacement as stated above are the exclusive remedies for the breach of this warranty. IN NO EVENT SHALL FLOWLINE BE LIABLE FOR ANY INCIDENTAL OR CONSEQUENTIAL DAMAGES OF ANY KIND INCLUDING PERSONAL OR REAL PROPERTY OR FOR INJURY TO ANY PERSON. THIS WARRANTY CONSTITUTES THE FINAL, COMPLETE AND EXCLUSIVE STATEMENT OF WARRANTY TERMS AND NO PERSON IS AUTHORIZED TO MAKE ANY OTHER WARRANTIES OR REPRESENTATIONS ON BEHALF OF FLOWLINE. This warranty will be interpreted pursuant to the laws of the State of California. If any portion of this warranty is held to be invalid or unenforceable for any reason, such finding will not invalidate any other provision of this warranty.

