



Specialist for Pumping Technology



HTP

Horizontal Turbine Pump

75 years developing the pumping technology that drives progress

Ruhrpumpen is an innovative and efficient pump technology company that offers highly engineered, custom made-solutions for oil & gas, chemical processing, power generation, industrial applications and water.

Implementation of cutting-edge technology and world-class engineering, combined with our unique vertically integrated structure, allows Ruhrpumpen to design complex technical solutions, creating the most robust and powerful pump systems in the marketplace.

Our broad product line complies with the most demanding quality standards and industry specifications such as **American Petroleum Institute (API)**, **American National Standards Institute (ANSI)**, **Underwriter's Laboratories (UL)**, **Factory Mutual (FM)**, **National Fire Protection Association (NFPA)**, **ISO and Hydraulic Institute**.

Products include:

- Single stage overhung pumps
- Vertical in-line pumps
- Single and multi-stage between bearing pumps
- Multi-stage vertical pumps
- Reciprocating plunger pumps
- Sealless magnetic drive pumps
- Fire protection systems
- Pitot tube pumps
- Hydraulic decoking systems
- Horizontal pumping systems



Ruhrpumpen is your single source supplier

- Original Equipment
- Spare parts
- Installation and startup support
- Repair and maintenance
- Engineering, training and consulting
- Reverse engineering

Benefits of our pumps:

- Proven reliability
- High efficiency designs ensure lowest operating cost
- Robust design allows for long system life with minimal maintenance
- Optimized total cost of ownership

HTP Pump

The HTP was designed with best practices in mind from hundreds of years of combined hydraulic and mechanical experience.

Ruhrpumpen HTP systems are designed for high volume and pressure applications using larger diameter pumps than those typically available in the market. Larger OD pumps result in shorter overall systems that produce more pressure for a given flow. The largest pumps can be configured with 15" OD and higher to accommodate flow rates in excess of 120,000 bpd per pump.

Ruhrpumpen has over 75 years of experience with thousands of multistage pumps installations globally. Many with much more stringent requirements than are typical for these applications. We are the true OEM experts on surface pump system manufacturing, commissioning, and troubleshooting with seasoned professionals on hand that know about the unique challenges that pump systems face on the surface versus downhole.



Features and Benefits

Features

Benefits

Efficiency – Power Utility Cost

- Industry leading hydraulic efficiency allows for lower power consumption, which equals lower OpEx over the life of the pump. As a proven supplier of a full API-610 & PD product line, we have taken our proven hydraulics from VLT/VTP pumps and adapted them to the HTP pump.

Low Maintenance - OpEX

- HTP systems are relatively low maintenance and typically just require changing the oil in the thrust chamber/cooler periodically.

Capital Expense

- Competitive pricing for the HTP systems allows for low initial investment.

Delivery Time

- Ruhrpumpen has a vertically integrated supply chain and is committed to manufacturing timeframes that exceed industry standards.

Flexible and modular

- If any of your application parameters change (e.g., flow and/or pressure) you can change everything on the system in-place with little downtime.
- It is common to install several HTP systems in parallel to increase capacity at the same site.

Reliability

- Reduced failure rates as there are no gear boxes or v-belts for motor connections. With a direct electric motor connection to the bearing frame, the number of wear components is reduced.

Simplicity

- The HTP system has easy access to the mechanical seal(s) either from the motor side or the pump side depending on the needs at the site.
- A variety of mechanical seal models and flush plans are available.

Pressure Rating Options

- RP offers a different pump construction for low pressure and high pressure applications using proven configurations from VLT/VTP pumps.
- Low pressure pumps are configured without housings which reduces lead times and associated costs while still being fit for purpose. The high-pressure pumps will be configured with housing materials rated to 6000 psi and above.

Markets and Applications



Oil & Gas

- Water disposal
- EOR
- CO² injection
- Amine transportation
- Jet Lift
- Condensate pipeline
- Pipeline pump
- Steam injection
- Boiler feeder

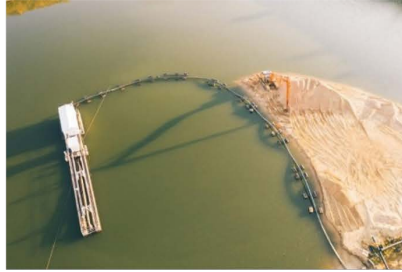

Mining

- Mining dewatering
- Mine washdown
- CBM well dewatering
- CBM injection water
- Dust control
- Pumping copper brine
- Pumping sea water
- Process pump



General Industry

- Industrial Process Fluids
- Reverse Osmosis
- Geothermal Injection
- CCUS
- Wash - down
- De - scaling
- Effluent Disposal
- Pipeline Booster
- High Pressure Transfer

HTP Operating Range and Components

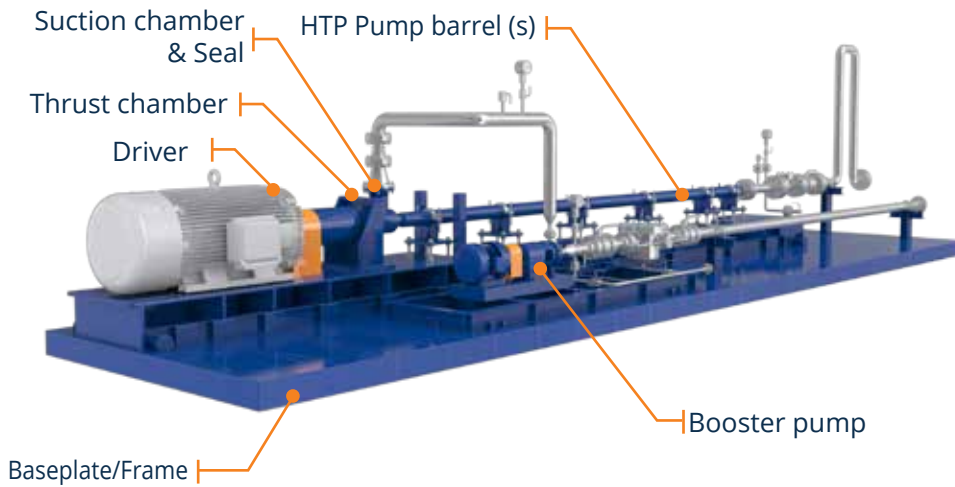

Duty Point	Min	Max
Flow	200 bpd	120 k bpd
Discharge Pressure	200 psi	6,250 psi
Suction Pressure	10 psi	3,000 psi

Motor Options		
Electric 50/60 Hz	75 HP	2,500 hp
Velocity	Fixed	Variable
Engine (*)	Gas	Diesel

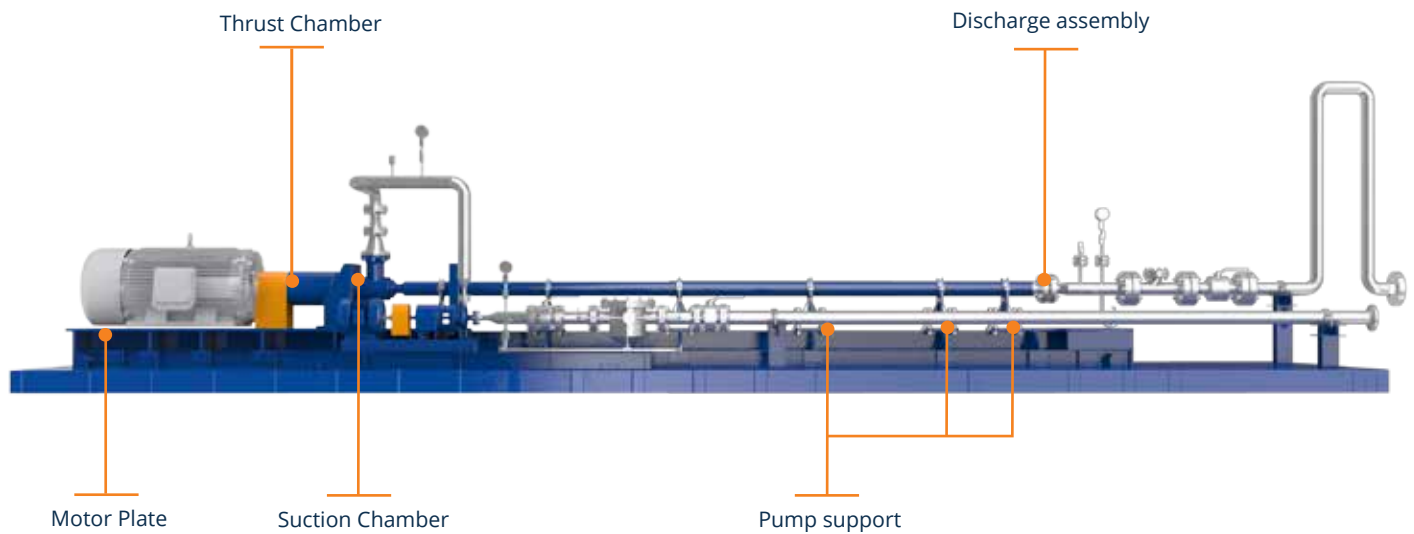

Standard Instrumentation**

Motor	<ul style="list-style-type: none"> Provisions for BTDs and WTDs
Thrust chamber	<ul style="list-style-type: none"> Vibration transmitter. Bearing RTD with transmitter.
Suction chamber / Discharge	<ul style="list-style-type: none"> Pressure transmitter with gauge.
Skid	<ul style="list-style-type: none"> Vibration transmitters

* Requires velocity increaser (gearbox).

** Different instrumentation configurations can be assembled based on customer requirements.

Horizontal Turbine Pump - HTP

HTP System-Components Drivers from 75 HP to 2,500 hp



Frequency	60 Hz	50 Hz
RPM, 2 poles	3,600 rpm	3,000 rpm
Low Voltage	460 - 480 v	380 - 415 v
Medium Voltage	2,300 - 4,160 v	1,000 - 3,000 v
Design	NEMA	I.E.C.

Industry Standard 2 pole NEMA and IEC foot mounted electric motors. Complies with customer requirements like enclosure type, voltage, frequency, insulation class, hazardous areas, among others. Additional drive options available including PMM, gas or diesel engine with speed increasers.

Skid Frame

- Rigid baseplates designed and manufactured in-house for smooth operation, **no vibration**, and ease of installation/start-up.
- Ability to **change motor sizes** without cutting metal or changing pipework height.
- **Modular design**, Simple to add or subtract stages/pumps.
- Skid **re-usable** in place for future applications.

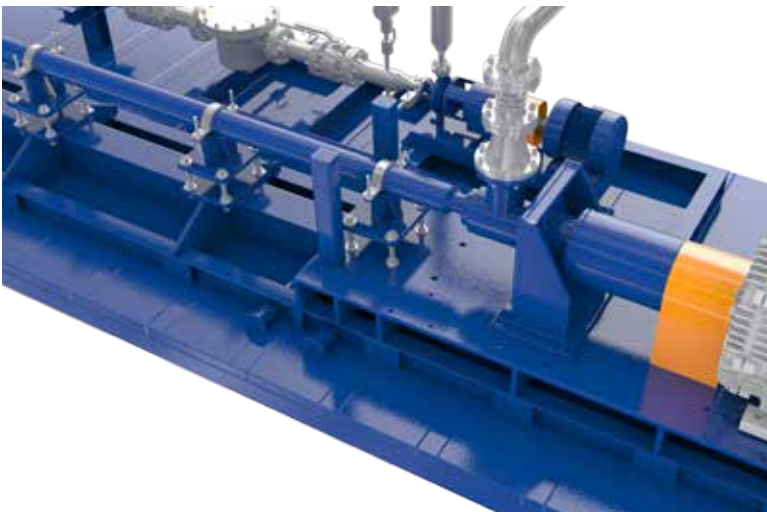
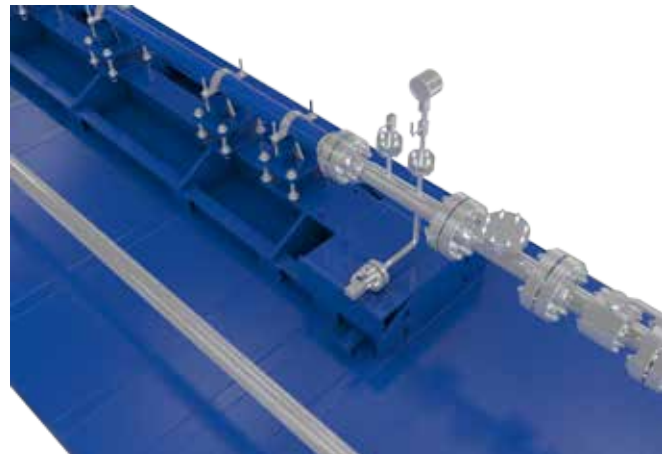

Thrust Chamber

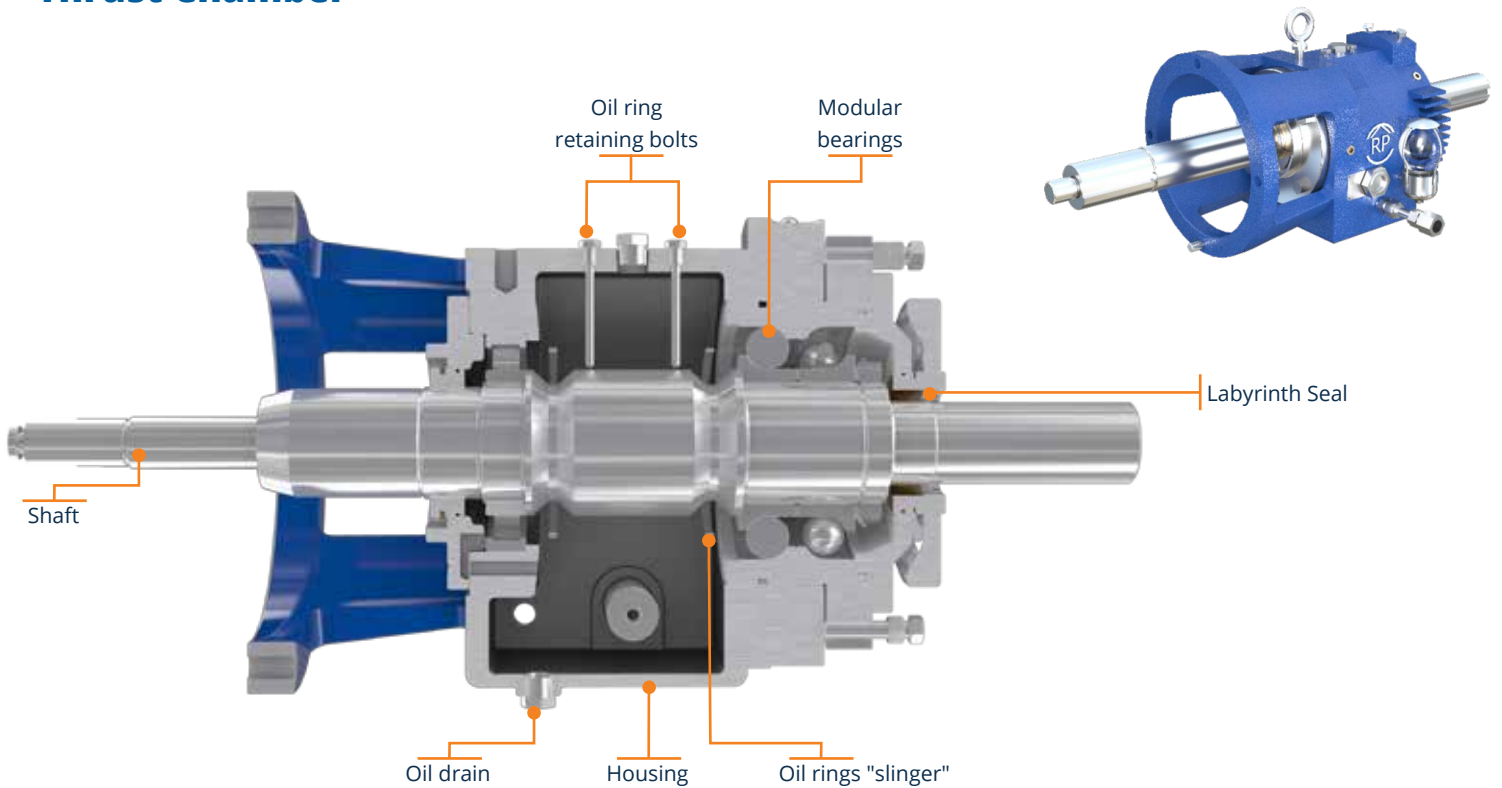

Proven modular design

- Multiple cooling options before dedicated external cooler is needed.
- Upgrade to higher thrust capacity in-place before moving to higher rated thrust chamber.

Ease of seal service

- Access and service the mechanical seal from either the suction side or the motor side.

Suction Chamber

- Flange options from 150# to 1500# to accommodate most applications.
- Cartridge seal options API682 and most API610 flush & quench plans are available.
- Use the same suction chamber when adapting to multiple different pump sizes.

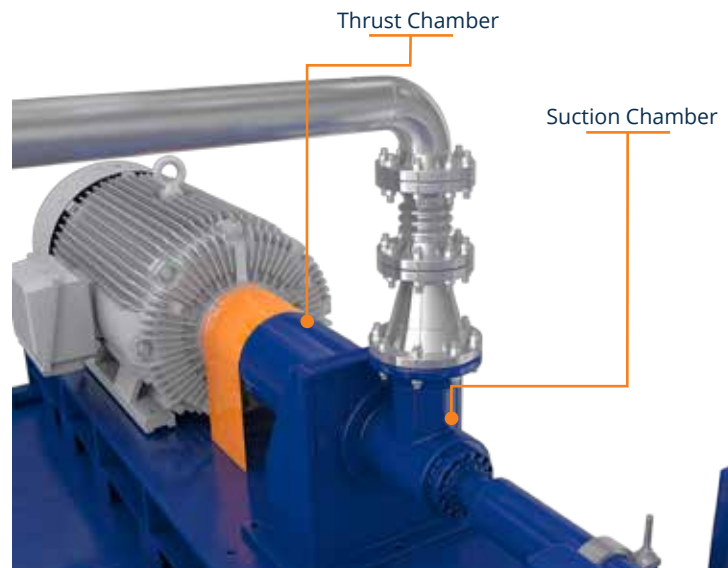

Horizontal Turbine Pump - HTP

A) Intake and Suction Flange

Available in sizes, materials, pressures and temperature ratings suitable for most applications. Standard flanges are ANSI B16.5 Class 150 to 2500, but special connections are available as well.

B) Mechanical Seal

Standard configuration is a type 2 component seal, but cartridge and bellow seal configurations are available depending on the application.

C) Discharge Flange

Available in sizes, materials, pressures and temperature ratings suitable for most applications. Standard flanges are ANSI B16.5 Class 600 to 2500, but special connections are available as well.

API Flush Plans

API specification compliant seals and flush plans available (e.g., plans 11,21,31,32, etc..) as per customer requirements.



Instrumentation

Standard instrumentation for HTP systems includes:

- Suction and discharge pressure transmitters with control switches.
- Vibration switches for motor, thrust chamber, and skid.
- Thrust chamber RTD and oil level.
- Junction Box for single point wiring (Class I div2 and XP enclosures).













+75 years creating the pumping technology that moves our world

Ruhrpumpen is an innovative and efficient pump technology company that offers highly-engineered and standard pumping solutions for the oil & gas, power generation, industrial, water and chemical markets. We offer a broad range of centrifugal and reciprocating pumps that meet and exceed the requirements of the most demanding quality specifications and industry standards such as API, ANSI, UL, FM, ISO and Hydraulic Institute.



Ruhrpumpen Plants

-  ARGENTINA, Buenos Aires
-  BRAZIL, Rio de Janeiro
-  CHINA, Changzhou
-  EGYPT, Suez
-  GERMANY, Witten
-  INDIA, Chennai
-  MEXICO, Monterrey
-  RUSSIA, Moscow
-  UK, Lancing
-  USA, Tulsa



Manufacturing plant & service center



Service center

- Antofagasta, Chile*
- Baton Rouge, USA*
- Bogota, Colombia*
- Buenos Aires, Argentina*
- Coatzacoalcos, Mexico*
- Hampton, USA*
- Houston, USA*
- Rio de Janeiro, Brazil*
- San Luis Potosi, Mexico*
- Santiago, Chile*