

F-2000

MODEL PC - MODEL PB - MODEL AO

OUTPUT BOARDS

INSTRUCTION MANUAL



Blue-White[®]
Industries, Ltd.

5300 Business Drive
Huntington Beach, CA 92649
USA

Phone: 714-893-8529 FAX: 714-894-9492
E mail: sales@blue-white.com or techsupport@blue-white.com
Website: www.blue-white.com

1.0 F-2000 Electrical Wiring Connections

1.1 Enclosure knock-out Instructions

Option A: Conduit Connection

1. Remove the red cap plug.
2. Install your pipe fitting (1/2 - 14 NPT male end).

Option B: Liquid-Tight Connections

1. Remove knock-out(s) using a screwdriver.
2. Trim edge(s) with a knife and remove sharp edges.
3. Install the provided liquid-tight connector(s).

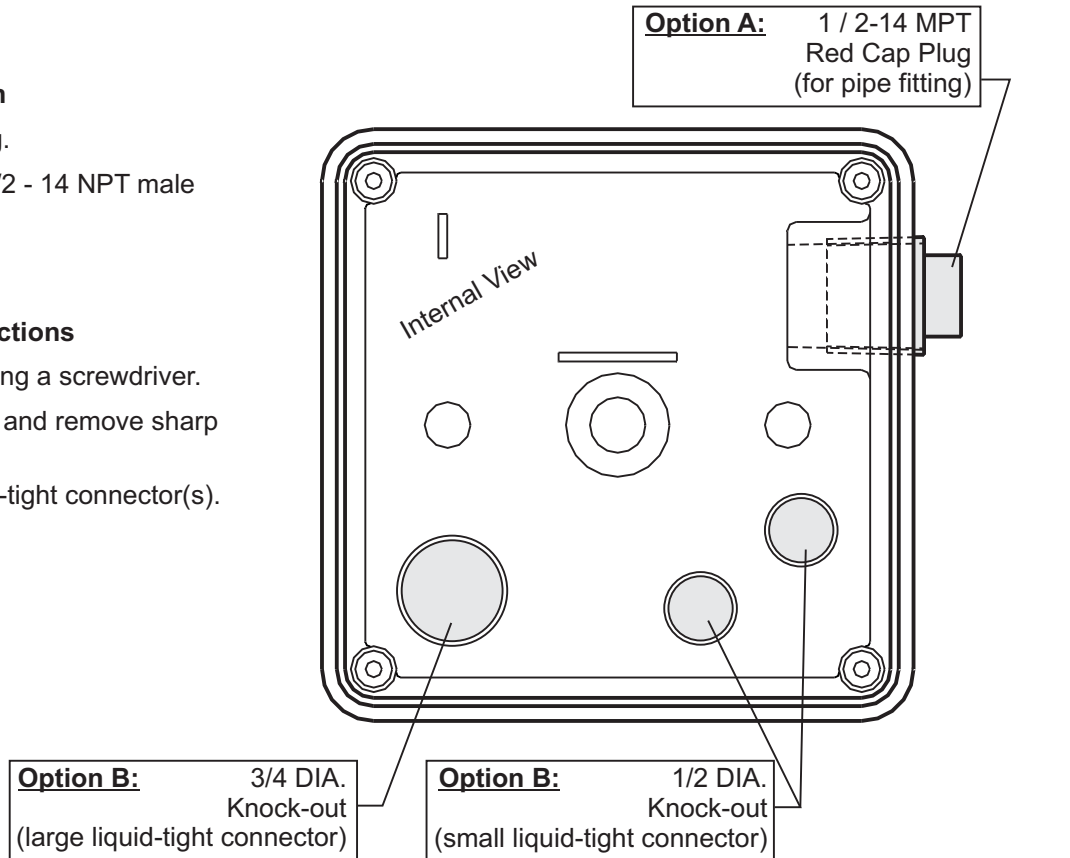

Notes:

For the large liquid-tight connector (3/4" Knock-out), the acceptable cable diameter is between .200 - .394 in (5.1 - 10.0 mm).

For the small liquid-tight connector (1/2" Knock-out), the acceptable cable diameter is between .118 - .255 in (3.0 - 6.5 mm).

1.2 Optional Circuit Board Installation

CAUTION: DISCONNECT POWER SOURCE BEFORE SERVICING.



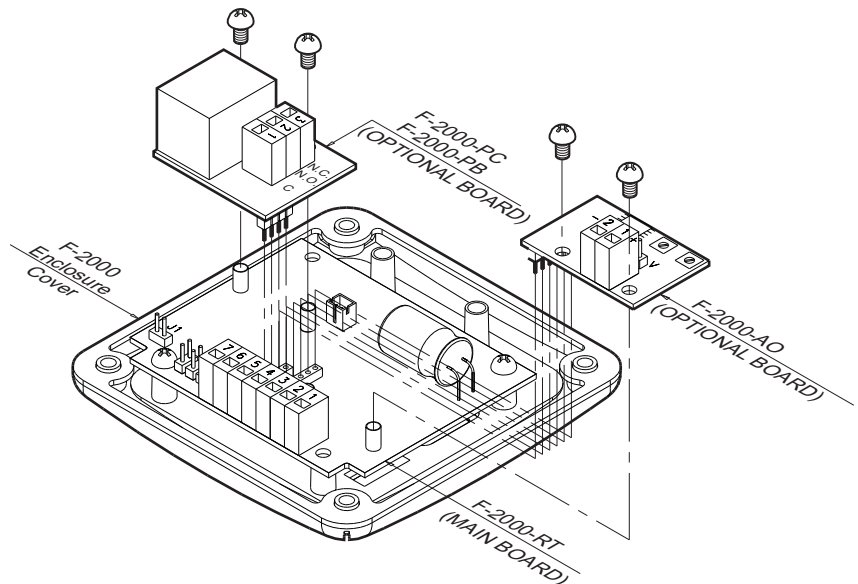



1. Carefully align optional board's Pin Header with the Pin Header socket located on the main circuit board.
2. Press firmly into place.
3. Secure the board with the two screws provided.



1.3 Model RT Circuit Board Wiring

CAUTION: DISCONNECT POWER SOURCE BEFORE SERVICING.

Jumper Configuration

Jumpers	Function
J1 Installed 	Battery Input (4 - 1.5 VDC, AA Cells)
J1 Left Open 	Plug-In Transformer (115 VAC / 15 VDC, 220 VAC / 15 VDC, 230 VAC / 15 VDC)
J2 Installed 	Front Panel Programming is Disabled
J2 Left Open 	Front Panel Programming is Enabled (factory default)
J3 Installed and J4 Left Open 	Hall Effect Sensor Input
J3 Left Open and J4 Installed 	AC Coil Sensor Input

Terminal Configuration

	Terminal	Function
Supply power input	6	Positive (+) power input (red wire from battery pack, or black with stripe wire from 15 VDC plug-in transformer)
	5	Ground (-) power input (black wire from battery pack or 15 VDC plug-in transformer)
AC coil sensor input	2	Ground (-) input (black wire from coil sensor body)
	3	Pulse input (yellow or red wire from coil sensor body)
Hall Effect sensor input	1	Positive (+) input (red wire from hall effect sensor)
	2	Ground (-) input (black wire from hall effect sensor)
	3	Pulse input (bare wire from hall effect sensor)
Open connector pulse output (from sensor)	7	NPN positive (+) signal output (Max voltage: 24VDC, Max load: 15mA, 2k ohm pull-up recommended.)
	4	NPN negative (-) signal output

F-2000 RT Board

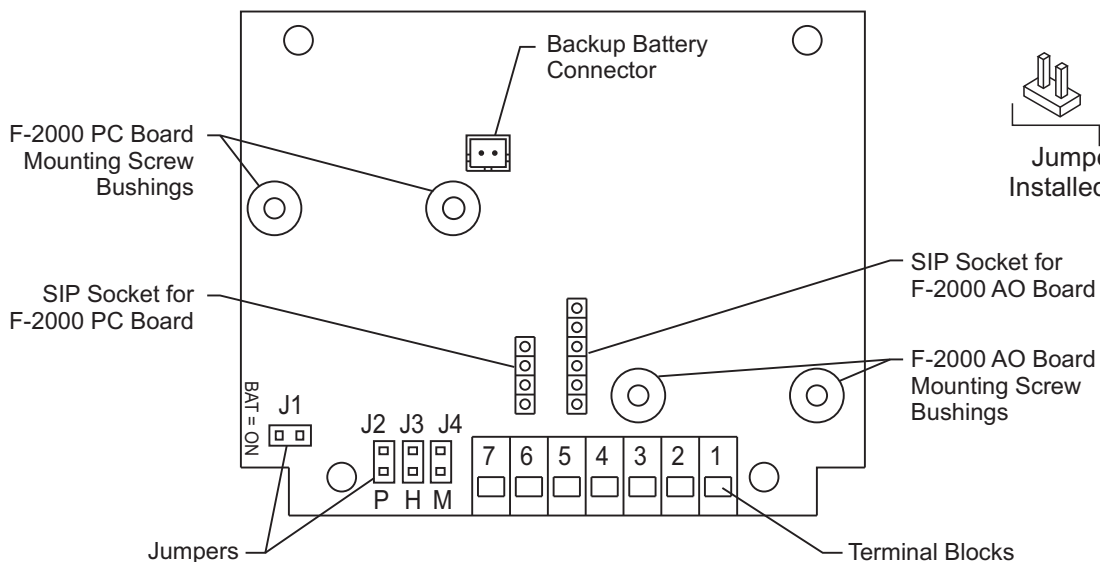

Jumper Positions

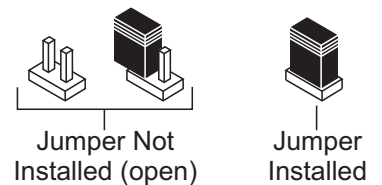

1.4 Model PC Circuit Board Wiring

CAUTION: DISCONNECT POWER SOURCE BEFORE SERVICING.

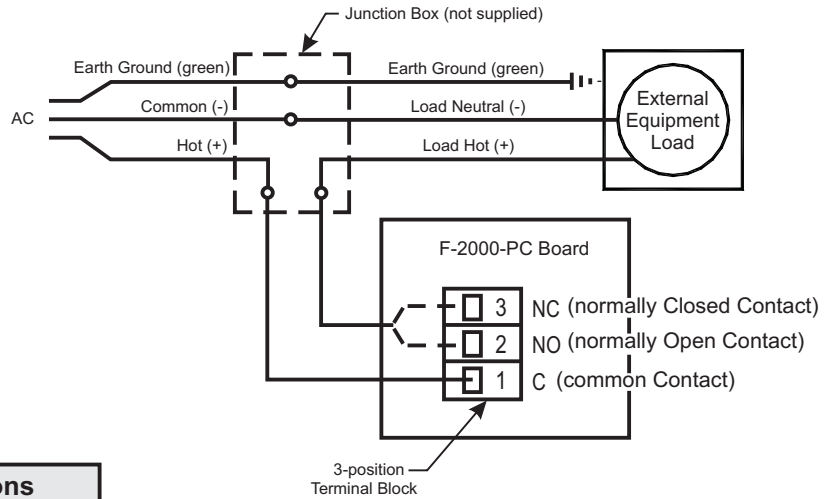
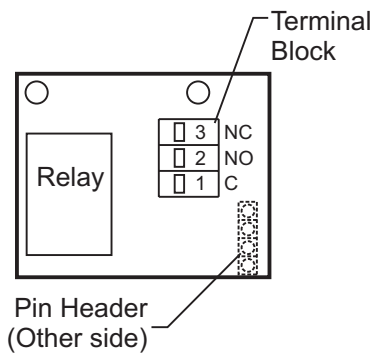

Terminal Configuration

Terminal	Terminal Block Connections
1	Common
2	NO (Normally Open) contact
3	NC (Normally Closed) contact

Output Type: Isolated relay SPDT (single poll double throw), NO / NC
 Max. Load: 8 amps (AC) @ 115 VAC, 220 VAC, 230 VAC
 7 amps (DC) @ 30 VDC (resistive load)
 Max. Voltage: 250 VAC, 125 VDC

1.5 Model PB Circuit Board Wiring

CAUTION: DISCONNECT POWER SOURCE BEFORE SERVICING.

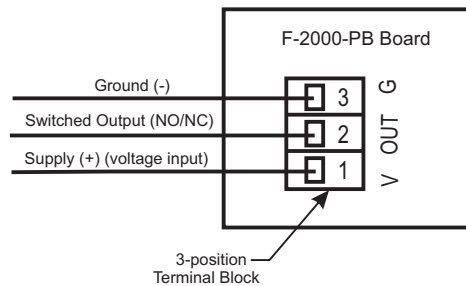
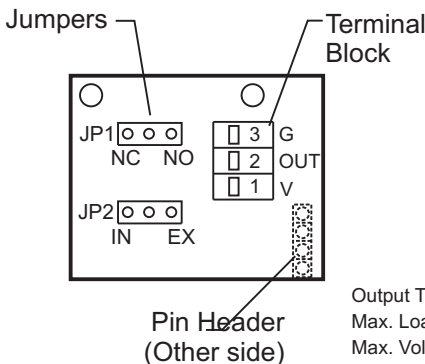

Output Type: Non-Isolated contact closure switch, NO / NC
 Max. Load: 100 milliamps (.10 amp)
 Max. Voltage: 30 VDC if JP2 is set for external power.
 15 VDC if JP2 is set for internal power and F-2000 is powered by plug-in transformer.
 3 VDC if JP2 is set for internal power and F-2000 is powered by Batteries.
 Max. Power: 3 Watts

Terminal Configuration

Terminal	Terminal Block Connections
1	Voltage input (+)
2	Switched output (NO/NC)
3	Ground (-)



Jumper Configuration

Jumper	Jumper Settings
JP1	NC = Normally closed contacts NO = Normally open contacts (default)
JP2	IN = Internal power EX = External power (default) Note: See above voltage limits

1.6 Model AO Circuit Board Wiring

CAUTION: DISCONNECT POWER SOURCE BEFORE SERVICING.

Jumper Configuration

Output	Jumper Settings
4-20 Milliamp	Connect P1 & P2 (leave P3 open) (factory default), Max Load = 250 Ohms 
0-10 Volts DC	Connect P2 & P3 (leave P1 open), Max Load = 500 Ohms 

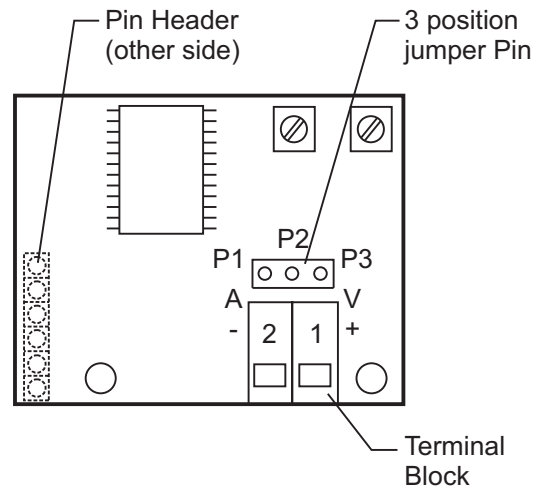

Terminal Configuration

Terminal Number	Terminal Block Connections
1	Positive (+) Analog Output Signal
2	Negative (-) Analog Output Signal

Output Type: Linear, Non-Isolated, powered loop.
 Loop resistance: 250 ohm maximum for 4-20mA output
 500 ohm maximum for 0-10 V DC

1.7 Model FHXX and FCXX Sensor wiring

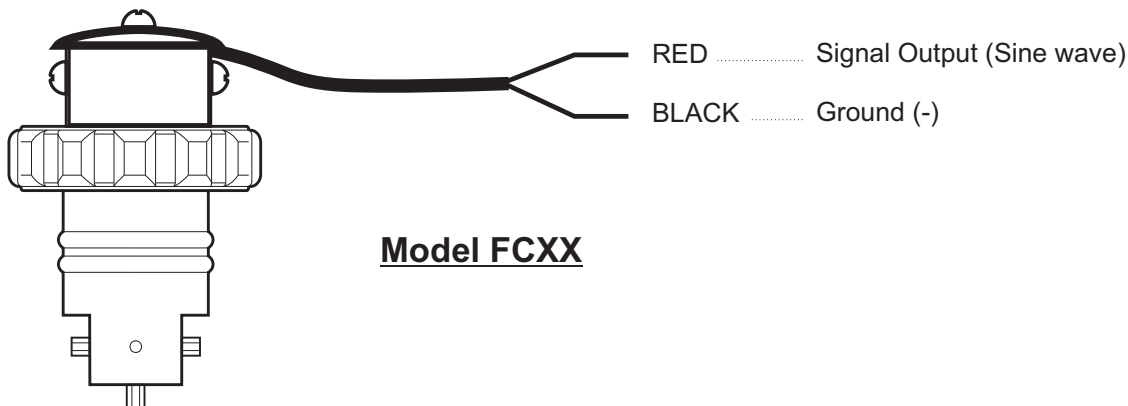
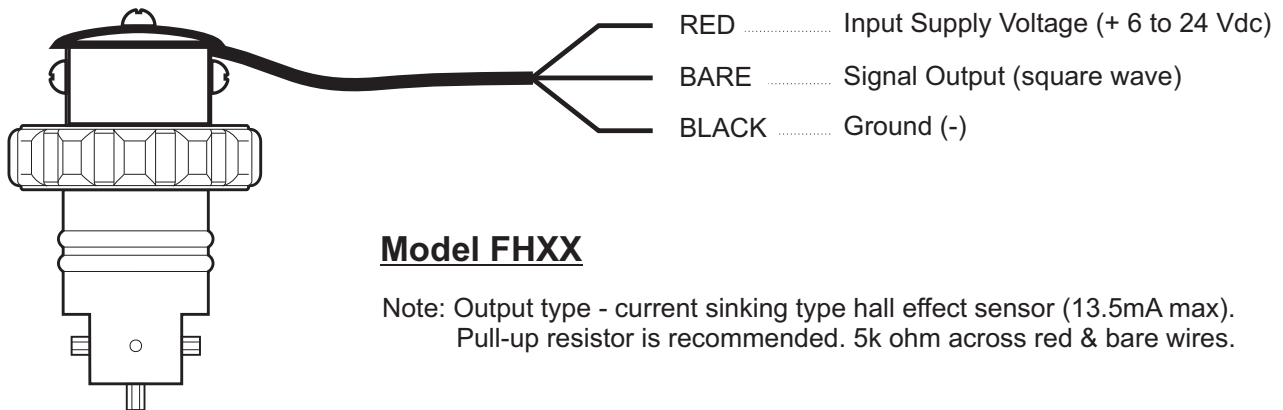

2.0 HOW TO OPERATE THE MODEL PC and MODEL PB

2.1 What Was The MODEL PC and PB Designed To Do?

In addition to the features of the MODEL RT, the model PC includes a single SPDT relay which can be used to switch an external component such as a pump, valve, alarm buzzer, etc., on and off in order to assist in the control of a process. The relay setpoints must be assigned to either the rate mode, the batch (total) mode, or turned off. **The MODEL PC cannot be battery operated.**

The MODEL PB offers all of the features of the MODEL PC but includes a contact closure switch instead of a relay and may be battery operated.

- High level flow rate alarm.
- Low level flow rate alarm.
- High and low level flow “range” alarm.
- Manual start or automatically timed start batch processing.
- Proportional chemical feed injector pump control.

2.2 What Features Are Available?

- All controls are front panel programmable.
- MODEL PC Max. switching load 8 Amp at - 115 VAC, 230 VAC, 220 VAC; 7 Amp at 30 VDC (resistive load).
- MODEL PB Max. switching load 100 milliamp at 30 VDC.
- NO / NC contact.
- Rate alarms can be latched requiring a manual reset.
- Programmable “alarm release value” provides hysteresis to prevent relay flickering (see page 28).
- High and low range alarms can be independently programmed.
- Alarm delay timer temporarily silences alarms for a programmed time from 0-999 seconds.
- Independent display and resetting of batch count and batch amount.
- Front panel clearing of batch counts and amounts can be disabled.
- Turn on / off external devices, for a programmable time from 0-999 seconds per batch.

2.3 How Do I Program The MODEL PC & PB?

The Model PC & PB setpoints must be assigned to either the rate mode (option 1), the batch (total) mode (option 2), or turned off (option 3).

- Option 1 -** Assign the setpoints to the RATE mode for applications involving the switching of external devices, such as alarms or valves, when the rate of flow is greater than or less than the programmed flow RATE value. The Model PC and PB is used to monitor flow RATE in this mode. **Example:** High or low flow rate alarms.
- Option 2 -** Assign the setpoints to the BATCH mode for applications involving the switching of external devices such as chemical metering pumps, centrifical pumps, solenoid valves, etc., when the amount of flow is greater than or less than the programmed batch amount value. In this mode, the Model PC is used to monitor flow total. **Example:** Manual batch processing or proportional feed rate control.
- Option 3 -** The OFF mode opens the relay contacts regardless of the flow conditions. The setpoints are not assigned.

SETPOINT MODE SELECTION PROGRAMMING SCREEN OPTIONS

OPTION	SELECTION	FUNCTION
Option - 1 (page 27)	Setpoint - RATE	Relay Setpoints are assigned to flow RATE mode.
Option - 2 (page 32)	Setpoint - BATCH	Relay Setpoints are assigned to BATCH (accumulative or “total”) mode.
Option - 3	Setpoint - OFF	Relay Setpoints are not assigned. Relay is not energized.

OPTION 1. RELAY SETPOINTS ARE ASSIGNED TO THE RATE MODE.

When the setpoint mode selection screen is assigned to RATE, the following program screens are available:

PROGRAMMING SCREEN	PROGRAMMING SCREEN FUNCTION
Setpoint - RATE - 1	High alarm flow RATE trigger value. (Factory default value = 000001)
Setpoint - RATE - 2	High alarm flow RATE release value. (Factory default value = 000001)
Setpoint - RATE - 3	Low alarm flow RATE trigger value. (Factory default value = 000001)
Setpoint - RATE - 4	Low alarm flow RATE release value. (Factory default value = 000001)
Setpoint - RATE - 5	Alarm reset delay time from 000 - 999 seconds. (Factory default value = 000)

The *relay setpoints* may be assigned in one of three ways:

Choice 1. High Alarm Only

The **High Alarm Trigger Setpoint** energizes the relay at a high flow rate value (high flow alarm). A single trigger value is assigned to a flow rate value greater than the normal flow rate. The relay will energize when the flow rate increases to the programmed value. In this option, the low trigger and release values are not used and should be programmed to a value of zero.

Choice 2. Low Alarm Only

The **Low Alarm Trigger Setpoint** energizes the relay at a low flow rate value (low flow alarm). A single trigger value is assigned to a flow rate value less than the normal flow rate. The relay will energize when the flow rate decreases to the programmed value. In this option, the high trigger and release values are not used and should be programmed to a value of zero.

Choice 3. High and Low Range Alarm Setpoints

The **Range Alarm Setpoints** energize the relay at both the high and low flow rate values (out-of-range alarm). Both the high and low trigger values must be assigned creating an acceptable range of flow. The relay will energize when the flow rate increases or decreases out of the acceptable range.

The *relay action* may be programmed in three ways:

Choice 1. Manual Unlatching requires the user to press the clear setpoints button to unlatch the relay (turn off the alarm). The relay is energized and latched when the trigger value is reached and remains energized and latched until the clear setpoints button is pressed.

To enable the feature, program the trigger and release values to the same value.

Choice 2. Automatic Unlatching requires the programming of a separate release point. When the setpoint is triggered, the relay will automatically unlatch when this release value is crossed.

To enable the feature, program a different trigger and release value. The high release value must be less than the high trigger value. The low release value must be greater than the low trigger value.

Choice 3. The Relay is Deactivated

To deactivate the relay, program all trigger and release values to zero.

NOTE: When latched, regardless of how the relay action is programmed, the relay may be unlatched manually by pressing the front panel "clear setpoints" button. However if there is still an alarm condition (high or low trigger value is exceeded), the relay will immediately re-latch. An alarm reset delay time can be programmed which will delay the re-latching of the relay even though the alarm condition still exists. If the relay is being used to switch an audible alarm, this feature allows for temporarily silencing the alarm, allowing time to affect repairs, without actually disabling the alarm feature. The programmable time range is from 0-999 seconds.

FLOW RANGE ALARM EXAMPLE

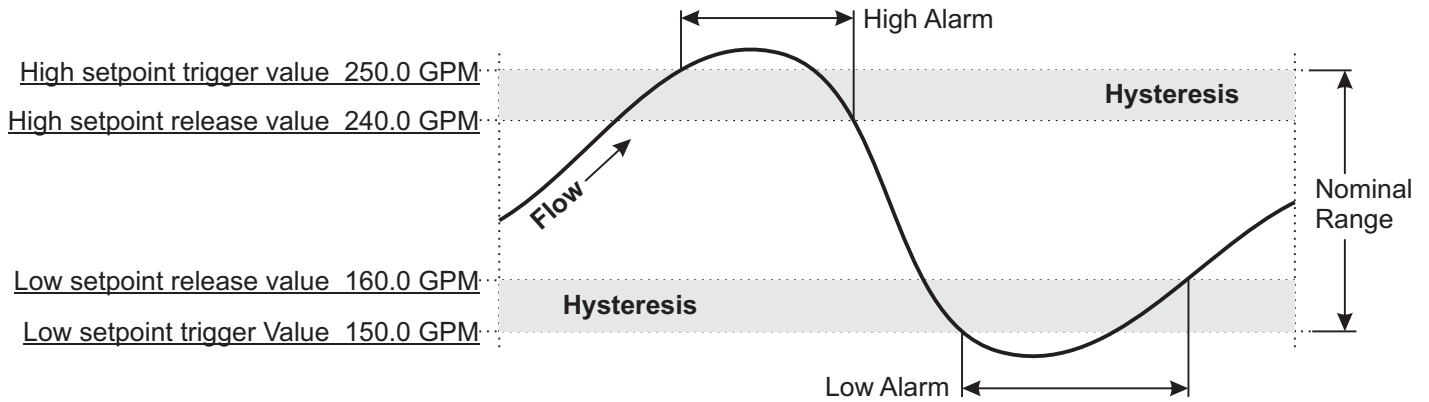

Note: If the relay flickers on and off due to unstable flow, readjust the release value to increase the amount of hysteresis.

2.4 Programming the MODEL PC & PB when the setpoints are assigned to rate.





Caution: An emergency shut off switch for externally controlled electrical equipment is recommended.

Note: The F-2000 must be powered by the AC Adapter.

Note: While in the programming mode, if no buttons are pressed within twenty seconds, the programming mode is automatically exited without saving the input of the last screen.



Step 1 Enter the programming mode and assign the setpoints to the RATE mode.





- Press  for at least 1.25 seconds.
- Press  to by-pass the first six program screens until you reach the Rate Setpoint Screen (seventh screen).
- Press  to select Rate Setpoint On.
- Press .

Step 2 Enter the High Alarm Trigger Value or 0.





- Press  to select the digit or decimal point to be modified. The selected digit will blink.
- Press  to change the selected digit. Note: Setting the value to zero disables the High Alarm.
- Press  when you have entered your desired High Alarm Trigger Value.



Step 3 **Enter the High Alarm Release Value or 0.**

- Press  to select the digit or decimal point to be changed. The selected digit will blink.
- Press  to change the selected digit. *Note:* This value must not be greater than the High Alarm Trigger Value.
- Press  when you have entered your desired High Alarm Release Value.

Step 4 **Enter the Low Alarm Trigger Value or 0.**

- Press  to select the digit or decimal point to be changed. The selected digit will blink.
- Press  to change the selected digit. *Note:* Setting the value to zero disables the Low Alarm.
- Press  when you have entered your desired Low Alarm Trigger Value.



Step 5 **Enter the Low Alarm Release Value or 0.**

- Press  to select the digit or decimal point to be changed. The selected digit will blink.
- Press  to change the selected digit. *Note:* This value must not be less than the Low Alarm Trigger Value.
- Press  when you have entered your desired Low Alarm Release Value.

Step 6 **Enter the Alarm Reset Delay Timer in seconds or press to bypass this screen.**

The alarm will be silenced (relay de-energized) for the programmed amount of time when  is pressed.

After the delay time, if the alarm condition still exists, the relay will re-energize. This feature allows the user to temporarily silence the alarm without disabling the alarm feature. The programmed time range is from 0 to 999 seconds.

- Press  to select the digit to be changed.
- Press  to change the selected digit. *Note:* Setting the value to zero disables the Alarm Reset Delay Timer.
- Press  to save your Alarm Reset Delay Time.

Step 7 **Press and hold down  for at least 1.25 seconds to exit.**

2.5 Examples of Setpoint Assigned to Rate.

Example 1: An audible alarm must sound when the flow rate goes out of the range of 25 to 35 gallons per minute.

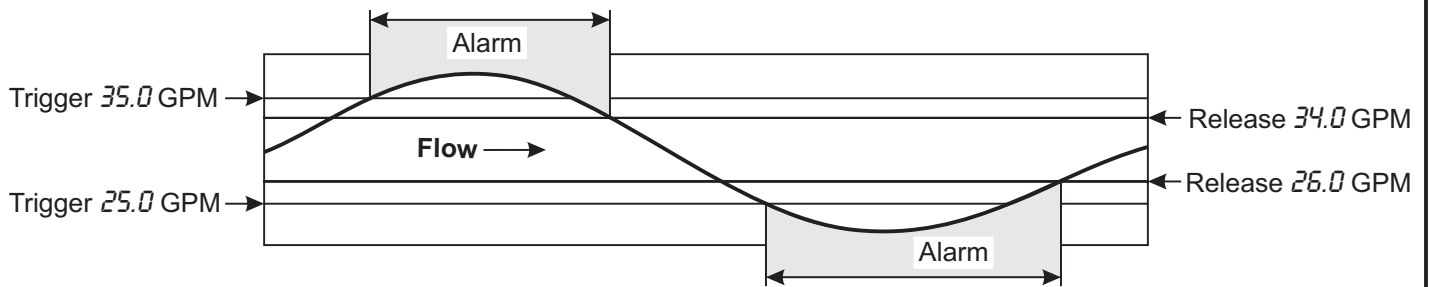

- Step 1** Set the SETPOINT MODE SELECTION screen to SETPOINT - RATE.
- Step 2** Set SETPOINT - RATE - 1, screen for a high range trigger value of 35.0.
- Step 3** Set SETPOINT - RATE - 2, screen for a high range release value of less than 35 and greater than 25. (If latching alarm is required, set the release value to 35).
- Step 4** Set SETPOINT - RATE - 3, screen for a low range trigger value.
- Step 5** Set SETPOINT - RATE - 4, screen for a low range release value of greater than 25 and less than 35. (If latching alarm is required, set the release value to 25).
- Step 6** Set SETPOINT - RATE - 5, to the desired alarm silencing delay time of 0 - 999 seconds(optional).
- Step 7** Wire the alarm to the normally open terminals of the relay terminal block. See page 16.

Example 2: An audible alarm must sound if the flow rate goes below 82.5 cubic meters per hour.

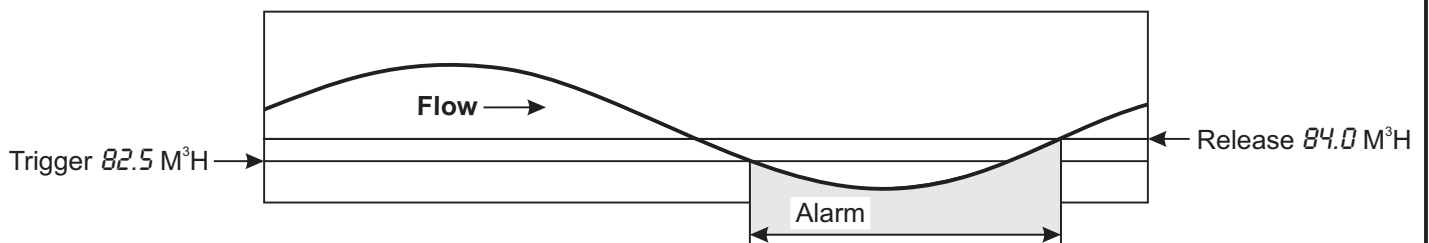

- Step 1** Set the SETPOINT MODE SELECTION SCREEN to SETPOINT - RATE.
- Step 2** Set SETPOINT - RATE - 1, screen for a high trigger value of 0. (High alarm not used, bypass).
- Step 3** Set SETPOINT - RATE - 2, screen for a high release value of 0. (High alarm not used, bypass).
- Step 4** Set SETPOINT - RATE - 3, screen for a low trigger value of 82.5.
- Step 5** Set SETPOINT - RATE - 4, screen for a low release value of greater than 82.5 (example: 84.0).
- Step 6** Set SETPOINT - RATE - 5, to the desired alarm silencing delay time of 0 - 999 seconds (optional).
- Step 7** Wire the alarm to the normally open terminals block. See page 16.

Example 3: A solenoid valve must open if the flow rate goes above 225 gallons per minute.

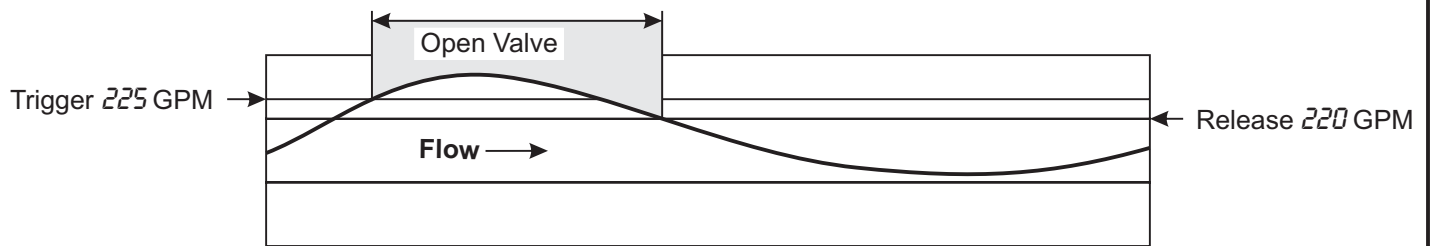

- Step 1** Set the SETPOINT MODE SELECTION SCREEN] to SETPOINT - RATE.
- Step 2** Set SETPOINT - RATE - 1, screen for a high trigger value of 225.
- Step 3** Set SETPOINT - RATE - 2, screen for a high release value of less than 225. Example: 220
- Step 4** Set SETPOINT - RATE - 3, screen for a low trigger value of 0. (Low alarm not used).
- Step 5** Set SETPOINT - RATE - 4, screen for a low release value of 0. (Low alarm not used).
- Step 6** Set SETPOINT - RATE - 5, to the desired alarm delay silencer time from 0 - 999 seconds (optional).
- Step 7** Wire the value to the normally open terminals of the relay terminal block. See page 16.

OPTION 2. RELAY SETPOINTS ARE ASSIGNED TO THE BATCH MODE.

BATCH AMOUNT - Two types of batch applications are available, manually started batches and automatically started batches. Both types require the programming of a batch amount value.

In a **manually started batch**, the relay is energized manually by the user when the front panel clear setpoint button is pressed and de-energized when the batch amount is reached. In this mode, the relay is switching a valve or other device that is controlling the flow being measured.

In an **automatically started batch**, the relay is energized and the external equipment timer is started when the batch amount is reached. The relay is de-energized at the end of the timer cycle.

AUTO RESET ON/OFF - The auto reset must be turned off for manual start batches and turned on for auto start batches.

EXTERNAL EQUIPMENT TIMER - The external equipment timer is only used with auto start batches.

When the setpoint mode selection screen is assigned to BATCH, the following program screens are available:

PROGRAMMING SCREEN	PROGRAMMING SCREEN FUNCTION
Setpoint - BATCH - 1	Batch amount value.
Setpoint - BATCH - 2	Auto reset on or off (on for auto timed batches and proportional feed control, off for manually reset batches)
Setpoint - BATCH - 3	External equipment timer amount in seconds (0 - 999).

MANUAL BATCH START APPLICATION

Manual batch start requires pressing the clear setpoints button to energize the relay. The relay de-energizes when the Batch Amount is reached. The clear setpoints button must be pressed again to begin the next batch.

CAUTION: A SEPARATE EMERGENCY SHUT-OFF SWITCH FOR EXTERNAL EQUIPMENT IS RECOMMENDED.

Application 1. Manual Batch Operation

In this operation, the relay is used to switch a device such as a valve or pump, *that is controlling* the flow being measured.

Example: a pump is turned on and off to fill containers to a preset amount of fluid. The fluid being pumped is also the fluid being measured by the F-2000.

1. The pump is wired to the normally open relay contacts of the F-2000.
2. Manually pressing the front panel “clear setpoints” button starts the batch by energizing the relay, which switches on power to the pump. The **SETPOINT** display icon illuminates.
3. The displayed Batch Number increments by one.
4. The displayed Batch Amount increases based on the pump flow rate.
5. When the programmed Batch Amount is reached, the relay de-energizes, turning off the pump. The **SETPOINT** display icon disappears.
6. The batch is complete.

Note: The batch may be interrupted and re-started by pressing the “clear setpoints” button. The **SETPOINT** display icon flashes.

AUTOMATIC BATCH START APPLICATION

Automatic Batch Start requires programming the EXTERNAL EQUIPMENT TIMER to a specific time from 000 - 999 seconds. When the batch amount is reached, the relay energizes and the timer starts. The relay de-energizes when the number of seconds programmed is reached.

Application 2. Proportional Chemical Feed Operation

In this operation, the relay is used to switch a device such as a valve or pump, *that is being controlled* by the flow being measured.

Example: A chemical injection pump is turned on for a preset amount of time when the Programmed Batch Amount is reached, thus injecting an amount of chemical per an amount of measured flow.

1. The chemical injection pump is wired to the normally open relay contacts.
2. The flow measurement begins.
3. The displayed Batch amount increases based on the flow rate being measured.
4. When the programmed Batch Amount is reached, the following occurs:
 - a. The external equipment timer begins.
 - b. The relay energizes turning on the chemical injection pump.
 - c. The Batch Amount Resets to zero.
 - d. The next batch flow rate measurement begins and the displayed Batch Amount increases.
 - e. When the External Equipment Timer cycle ends, the relay de-energizes turning off the chemical injection pump.
5. The displayed Batch Number increments by one.
6. The batch is complete.

Note: The chemical pump may be stopped and re-started by pressing the clear setpoints button.

Application 3. Automatically Timed Batching Operation

In this operation, the relay is used to switch a device, such as a valve or pump, *that is controlling* the flow being measured.

Example: A solenoid valve is wired to the normally closed contact of the F-2000 relay. In the de-energized relay state, the valve is energized and open, which permits the flow being measured to flow. When the programmed batch amount is reached, the relay is energized, opening the relay circuit which closes the valve, and a time delay cycle begins. After the time delay cycle, the relay de-energizes which opens the solenoid valve and the next batch begins.

CAUTION: WHEN WIRED TO THE NORMALLY CLOSED CONTACTS OF THE RELAY, EXTERNAL EQUIPMENT WILL BE ENERGIZED IF THE CLEAR SETPOINTS BUTTON IS PRESSED. A SEPARATE EMERGENCY SHUT-OFF SWITCH FOR EXTERNAL EQUIPMENT IS RECOMMENDED.

1. The solenoid valve is wired to the normally closed contacts.
2. The flow measurement begins.
3. The displayed Batch Amount increases based on the flow rate being measured.
4. When the programmed Batch Amount is reached, the following occurs:
 - a. The time delay cycle (External Equipment Timer) begins.
 - b. The relay energizes closing the valve which stops the flow.
 - c. The batch amount resets to zero.
5. When the External Equipment Timer cycle ends, the relay de-energizes, opening the solenoid valve.
6. The displayed Batch Number increments by one.
7. The batch is complete.





2.6 Programming The MODEL PC & PB When Setpoints Are Assigned To Batch

Note: The F-2000 must be powered by the AC adapter.

CAUTION: A SEPARATE EMERGENCY SHUT-OFF SWITCH FOR EXTERNAL EQUIPMENT IS RECOMMENDED.

Step 1 Enter the programming mode and assign the setpoint to the BATCH mode.





- Press  for at least 1.25 seconds.
- Press  to by-pass the first six program screens until you reach the Batch Setpoint Screen (seventh screen).
- Press  to select Batch Setpoint ON.
- Press  .

Step 2 The Setpoint Batch-1 screen, Batch Amount Value is selected.



This screen is used to enter the batch amount value. The relay will energize when the accumulated total flow equals the programmed value.



- Press  to select the digit or the decimal to be modified. The selected digit will blink.
- Press  to change the selected digit.
- Press  when you have finished.

Step 3 The Setpoint Batch-2 screen, Auto Batch Start On or Off is enabled.



This screen is used to toggle the auto Batch Start function On and Off.

Note: Select **On** for auto-Start Batches and **Off** for manual Start Batches.



- Press  to select On or Off.
- Press  when you have finished.

Step 4 The Setpoint Batch-3 screen, external equipment Timer amount (in seconds) is displayed.



This screen is used to enter the number of seconds per batch that the relay will be energized.

Note: Set to zero for manual Start Batch operations.

- Press  to select the digit to be modified.
- Press  to change the selected digit.
- Press  when you've finished.

2.7 Examples of Setpoint Assigned To Batch

Example 1: Proportional feed application. A chemical feed pump must run for 3 seconds for every 12.57 liters of flow measured.

- Step 1** Set the SETPOINT MODE SELECTION screen to SETPOINT - BATCH.
- Step 2** Set SETPOINT - BATCH - 1 screen for a batch amount value of 000012.57
- Step 3** Set SETPOINT - BATCH - 2 screen for automatic batch start.
- Step 4** Set SETPOINT - BATCH - 3 screen for external equipment timer on-time of 003 seconds.
- Step 5** Wire the pump to the normally open terminals of the relay terminal block.
- Step 6** The pump will start automatically when the batch amount is reached.

Example 2: Manual batch application. In a truck depot, an attendant must open a solenoid valve allowing 2,000 gallons of water to flow into each truck.

- Step 1** Set the SETPOINT MODE SELECTION screens to SETPOINT - BATCH
- Step 2** Set SETPOINT - BATCH - 1 screen for a batch amount value of 00002000
- Step 3** Set SETPOINT - BATCH - 2 screen for automatic BATCH START OFF.
- Step 4** Set SETPOINT - BATCH - 3 screen for external equipment timer on-time of 000 seconds.
- Step 5** Wire the solenoid valve to the normally open terminals of the relay terminal block.
- Step 6** Press  to begin the first batch.

3.0 HOW TO OPERATE THE MODEL AO

3.1 What Was The MODEL AO Designed To Do?

- Output a 4-20mA or 0-10VDC signal which is proportional to the flow.

3.2 What Features Are Available?

- Front panel programmable zero and span.
- 20-4mA and 10-0VDC inverted logic capabilities.
- Front programming can be disabled for security.
- 4-20mA or 10VDC output signal (factory default) selected via jumper pin located on the circuit board.

3.3 How Do I Program The MODEL AO?





Note: The F-2000 must be powered by AC Adapter

Note: The output signal can be inverted. Either the low or the high output signal may be assigned to the lower or

Programming Screen	Programming Screen Function
MA 1	Input the desired flow rate which corresponds to an output signal of 4mA or 0VDC. This value may be either the high or the low point in the range.
MA 2	Input the desired flow rate which corresponds to an output signal of 20mA or 10VDC. This is the opposite range point from the MA 1 setting (above).



Step 1 MA 1, Flow Rate at Low Output Signal (4mA or 0VDC).



- Press  for at least 1.25 seconds to activate programming mode.
- Press  to toggle through the different display screens until you reach the MA screen.
- Press  to select the digit to be changed. *Note:* The selected digit will blink.
- Press  to change the selected digit.
- Press  .

Step 2 MA 2, Flow Rate at High output Signal (20mA or 10VDC).



- Press  to select the digit to be changed.
- Press  to change the selected digit.
- Press  .

4.0 Programming Menu Flow Chart

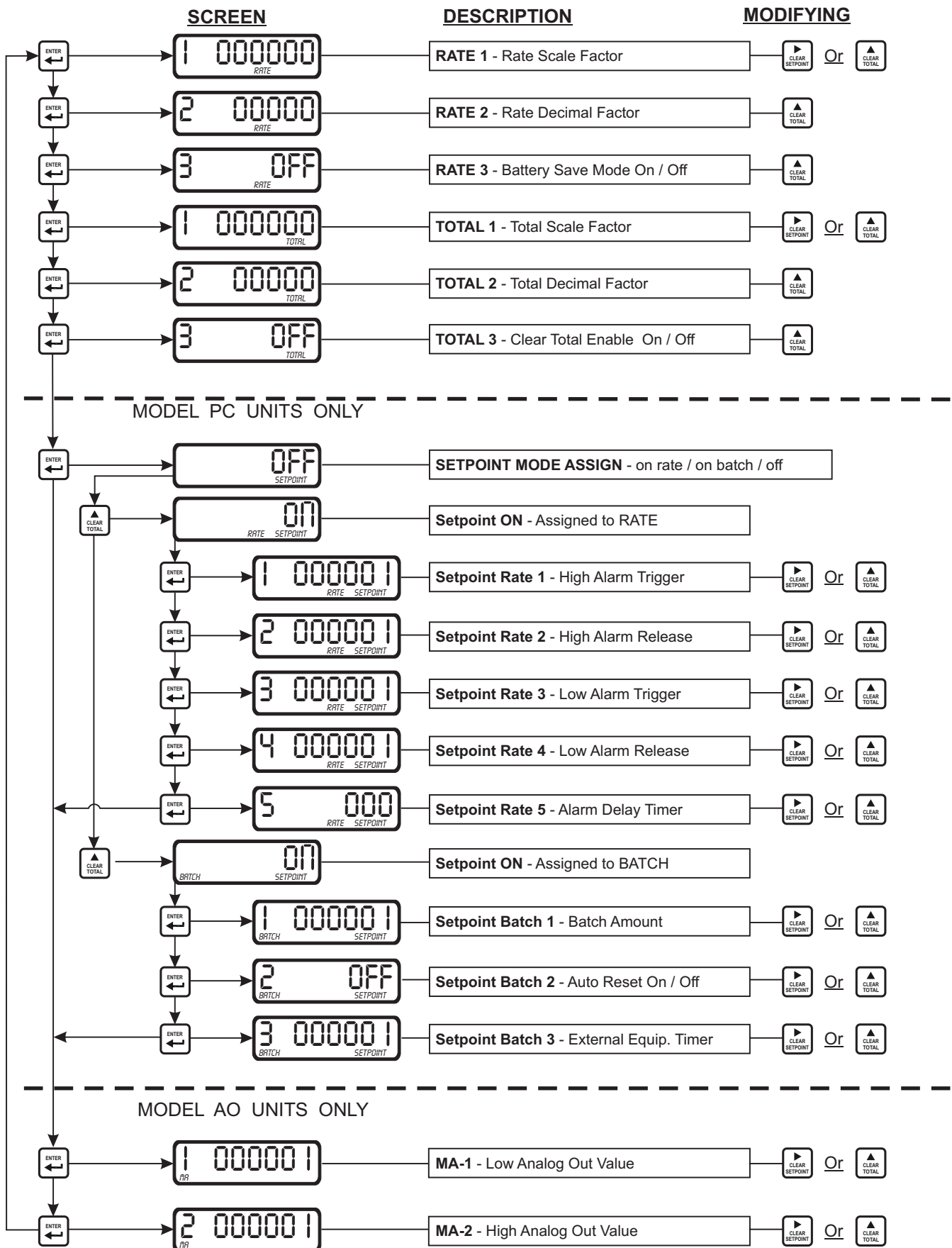

Warranty

- Blue-White flowmeters are warranted to be free from defects in material and workmanship for 12 months from date of factory shipment. Warranty coverage is limited to repair or replacement of the defective flowmeter only.
- This warranty does not cover damage to the flowmeter that results from misuse or alterations, nor damage that occurs as a result of: meter misalignment, improper installation, over tightening, use of non-recommended chemicals, use of non-recommended pipe dopes or adhesives, excessive heat or pressure or allowing the meter to support the weight of related piping.
- Flowmeters are repaired at the factory only. Call or write the factory to receive a RA (return authorization) number. Carefully pack the flowmeter to be returned, including a brief description of the problem, chemical used, and a description of the application. Note: Write the RA number on the outside of the shipping carton.
- Prepay all shipping costs. The factory does not accept C.O.D. Shipments. Damage that occurs during shipping is the responsibility of the sender.



Users of electrical and electronic equipment (EEE) with the WEEE marking per Annex IV of the WEEE Directive must not dispose of end of life EEE as unsorted municipal waste, but use the collection framework available to them for the return, recycle, recovery of WEEE and minimize any potential effects of EEE on the environment and human health due to the presence of hazardous substances. The WEEE marking applies only to countries within the European Union (EU) and Norway. Appliances are labeled in accordance with European Directive 2002/96/EC.

Contact your local waste recovery agency for a *Designated Collection Facility* in your area.