

## SERIES C2V / C3V

Operating Manual



**ProSeries**<sup>®</sup>  
by Blue-White Ind.

5300 Business Drive, Huntington Beach, CA 92649 USA

Phone: 714-893-8529 FAX: 714-894-9492

E mail: [sales@blue-white.com](mailto:sales@blue-white.com) | [techsupport@blue-white.com](mailto:techsupport@blue-white.com) URL: [www.Blue-White.com](http://www.Blue-White.com)

## TABLE OF CONTENTS

<u>Section</u>	<u>Heading</u>	<u>Page</u>
1.0	Introduction . . . . .	3
1.1	Available Models . . . . .	3
2.0	Specifications . . . . .	4
2.1	Materials of Construction . . . . .	4
3.0	Features . . . . .	5
3.1	Agency Listings . . . . .	5
4.0	Installation. . . . .	6
4.1	Mounting Location . . . . .	6
4.2	Dimensions . . . . .	6
4.3	Installing Injection Fitting and Strainer . . . . .	7
5.0	Power Connections . . . . .	8
5.1	Wiring Terminal and I/O Schematics . . . . .	9
6.0	How to Operate Chem-Pro - Control Pad. . . . .	10
6.1	Mode Descriptions. . . . .	11
7.0	Mode 0 - Set Remote Start/Stop . . . . .	12
7.1	Mode 0 - Set TFD Sensitivity. . . . .	13
7.2	Mode 0 - Set FVS (flow verification system). . . . .	14, 15
7.3	Mode 0 - Set 4-20mA Output. . . . .	16, 17
8.0	Mode 1 - Manual Operation . . . . .	18, 19
8.1	Mode 1 - Manual Operation Screen Shots . . . . .	19
9.0	Mode 2 - 4-20mA Input Operation . . . . .	20, 21
9.1	Mode 2 - 4-20mA Input Screen Shots . . . . .	21
10.0	Mode 3 - Frequency Input (Hz) Operation . . . . .	22, 23
11.0	Mode 4 - Pulse Batch (low speed pulse) Operation . . . . .	24, 25
11.1	Mode 4 - Pulse Batch Operation Screen Shots . . . . .	25
12.0	Alarm Relay. . . . .	26
13.0	Volumetric Test - Calibration . . . . .	26
14.0	Priming Pump . . . . .	27
15.0	Pump Maintenance . . . . .	27
15.1	Routine Inspection and Maintenance. . . . .	27
15.2	Cleaning Pump . . . . .	27
15.3	Motor Brush Replacement . . . . .	28
16.0	Replacement Parts List . . . . .	30
16.1	C2 Parts List . . . . .	30
16.2	C3 Parts List . . . . .	31
17.0	DFD (Diaphragm Detection System) . . . . .	32
18.0	Output Versus Pressure . . . . .	33
18.1	C2 Output V. Pressure . . . . .	33
18.2	C3 Output V. Pressure . . . . .	33
	Warranty . . . . .	34

PLEASE READ ENTIRE INSTRUCTION MANUAL PRIOR TO INSTALLATION AND USE.

## 1.0 Introduction

Congratulations on purchasing Chem-Pro® variable speed Diaphragm Metering Pump. A diaphragm pump is a type of positive displacement pump used for pumping a variety of fluids.

Your Chem-Pro® pump is pre-configured for diaphragm, pump head and fittings that shipped with your metering pump.

**Please Note:** Your new pump has been pressure tested at the factory with clean water before shipping. You may notice trace amounts of clean water in pump head. This is part of our stringent quality assurance program at Blue-White Industries.

## 1.1 Available Models

<b>C2V Diaphragm Metering Pump</b>					<b>Max. 166 Strokes Per Minute</b>		
<b>No Metal in fluid path</b>							
<b>Feed Rate at 0 PSIG</b>			<b>Max Pressure</b>	<b>Connection Type</b>	<b>C2V Model Numbers</b>		
<b>GPH</b>	<b>LPH</b>	<b>ML/Min</b>	<b>PSIG (bar)</b>	<b>Fittings</b>	<b>115V AC</b>	<b>230V AC</b>	<b>220V AC</b>
.06 - 6.0	.22 - 22	3.60 - 360	175 (12)	1/2" Male NPT / PVDF	C2V243XVA	C2V253XVA	C2V263XVA
.06 - 6.0	.22 - 22	3.60 - 360	175 (12)	1/2" Female NPT / PVDF	C2V243XVB	C2V253XVB	C2V263XVB
.06 - 6.0	.22 - 22	3.60 - 360	175 (12)	1/2" Hose Barb / PVDF	C2V243XVC	C2V253XVC	C2V263XVC
.06 - 6.0	.22 - 22	3.60 - 360	175 (12)	3/8" Tube compression/ PVDF	C2V243XVD	C2V253XVD	C2V263XVD
.10 - 10	.38 - 38	5.50 - 550	175 (12)	1/2" Male NPT / PVDF	C2V241XVA	C2V251XVA	C2V261XVA
.10 - 10	.38 - 38	5.50 - 550	175 (12)	1/2" Female NPT / PVDF	C2V241XVB	C2V251XVB	C2V261XVB
.10 - 10	.38 - 38	5.50 - 550	175 (12)	1/2" Hose Barb / PVDF	C2V241XVC	C2V251XVC	C2V261XVC
.10 - 10	.38 - 38	5.50 - 550	175 (12)	3/8" Tube compression/ PVDF	C2V241XVD	C2V251XVD	C2V261XVD
.15 - 15	.55 - 55	9.20 - 920	175 (12)	1/2" Male NPT / PVDF	C2V242XVA	C2V252XVA	C2V262XVA
.15 - 15	.55 - 55	9.20 - 920	175 (12)	1/2" Female NPT / PVDF	C2V242XVB	C2V252XVB	C2V262XVB
.15 - 15	.55 - 55	9.20 - 920	175 (12)	1/2" Hose Barb / PVDF	C2V242XVC	C2V252XVC	C2V262XVC
.15 - 15	.55 - 55	9.20 - 920	175 (12)	3/8" Tube compression/ PVDF	C2V242XVD	C2V252XVD	C2V262XVD

<b>C3V Diaphragm Metering Pump</b>					<b>Max. 130 Strokes Per Minute</b>		
<b>No Metal in fluid path</b>							
<b>Feed Rate at 0 PSIG</b>			<b>Max Pressure</b>	<b>Connection Type</b>	<b>C3V Model Numbers</b>		
<b>GPH</b>	<b>LPH</b>	<b>ML/Min</b>	<b>PSIG / bar</b>	<b>Fittings</b>	<b>115V AC</b>	<b>230V AC</b>	<b>220V AC</b>
.25 - 25	.96 - 96	16.00 - 1600	150 / 10.3	1/2" Male NPT / PVDF	C3V241XVA	C3V251XVA	C3V261XVA
.25 - 25	.96 - 96	16.00 - 1600	150 / 10.3	1/2" Female NPT / PVDF	C3V241XVB	C3V251XVB	C3V261XVB
.25 - 25	.96 - 96	16.00 - 1600	150 / 10.3	1/2" Hose Barb / PVDF	C3V241XVC	C3V251XVC	C3V261XVC
.40 - 40	1.53 - 153	25.50 - 2550	100 / 6.8	1/2" Male NPT / PVDF	C3V242XVA	C3V252XVA	C3V262XVA
.40 - 40	1.53 - 153	25.50 - 2550	100 / 6.8	1/2" Female NPT / PVDF	C3V242XVB	C3V252XVB	C3V262XVB
.40 - 40	1.53 - 153	25.50 - 2550	100 / 6.8	1/2" Hose Barb / PVDF	C3V242XVC	C3V252XVC	C3V262XVC

•Chem-Pro® Pumps motor speed is linear over the entire 1% to 100% adjustment range.

•Output versus pressure is nearly linear in all models.

•Feed rates taken in laboratory environment with clean water after 20 minute diaphragm break-in period with a 3 foot (1 meter) suction lift.

### Optional Extended Brackets

Stainless Steel extended brackets allow pump to be securely mounted to most any surface; floor, shelf, or skid. Brackets lift pump up 4-1/2 inches (11.43 cm), for easy pump access in hard to reach areas.

- Raise metering pump 4-1/2 inches (11.43 cm) off ground or a surface.
- Made out of tough Stainless Steel.
- Provides a stable mounting surface.

<b>Model #</b>	<b>Description</b>
72000-380	Extended Mounting Bracket, 1 Pair, SS, 4 SS Screws



## 2.0 Specifications

### Maximum working pressure\*:

175 psig (12 bar), \*model specific  
Note: see individual pump model maximum pressure ratings.

### Maximum Fluid temperature (excluding pump tubes):

130° F (54° C)  
Note: see individual pump tube assembly maximum temperature ratings.

### Maximum fluid viscosity:

1,000 Centipoise

### Maximum suction lift:

15 ft. Water, 0 psig (4.5 m, 0 bar)

### Ambient Operating Temperature

14°F to 115°F (-10°C to 46°C)

### Ambient Storage Temperature

-40°F to 158°F (-40°C to 70°C)

### Operating Voltage:

115VAC/60Hz, 1ph (1.5 Amp Maximum)  
230VAC/60Hz, 1ph (0.7 Amp Maximum)  
220VAC/50Hz, 1ph (1.0 Amp Maximum)  
240VAC/50Hz, 1ph (1.0 Amp Maximum)

### Power Cord Options:

115V60Hz = NEMA 5/15 (USA)  
230V60Hz = NEMA 6/15 (USA)  
220V50Hz = CEE 7/VII (EU)  
240V50Hz = AS 3112 (Australia/New Zealand)

### Motor:

Brushed DC, 1/8 H.P.

### Duty cycle:

Continuous

### Motor speed adjustment range 100:1:

1.0% - 100% motor speed (1.3 to 130 RPM)

### Motor speed adjustment resolution:

0.1% increments

### Accuracy:

+/- 2% of full scale  
Repeatability +/- 0.5%

### Display

Backlit LCD, UV resistant.

### Keypad

Five button positive action tactile switch keypad.

### Enclosure:

NEMA 4X (IP66), Powder coated aluminum.  
Maximum overall dimensions:  
C2 models: 11-3/4"W x 7-3/4"H x 10-3/4"D (298W x 197H x 274D mm)  
C3 models: 13-1/8"W x 9"H x 10-3/4"D (333W x 228H x 274D mm)

### Approximate shipping wt:

C2 models: 24 lb. (10.9 Kg)  
C3 models: 29 lb. (13.1 Kg)

## 2.1 Materials of construction

### Wetted components:

#### Pump Head Assembly:

Pump Head: .....PVDF  
Adapter Connections: .....PVDF  
Prime/Degassing Valve: .....PVDF  
Valve Cartridges: .....PVDF  
Valve Balls: .....Ceramic  
Valve Ball Seats: .....TFE/P  
Tetrafluorethylene/propylene  
Static Seals: .....Viton® (optional EP)  
Diaphragm: .....PTFE® coated Hypalon®

#### Injection / Back-flow Check valve:

Body & insert: .....PVDF  
Check Ball: .....Ceramic  
Spring: .....Hastelloy C-276  
O-ring seals: .....Viton® (optional EP)

#### Foot Valve / Strainer:

Body & Adapter: .....PVDF  
Check Ball: .....Ceramic  
Spring: .....Hastelloy C-276  
O-ring seals: .....Viton® (optional EP)  
Filter screen: .....Polypropylene

Suction Tubing: .....Clear PVC (if supplied)

#### Discharge Tubing

3/4" x 1/2" Tube connections: ....Not supplied  
1/4" x 3/8" Tube connections: ....Natural Polyethylene (LLDPE)

### Non-Wetted components:

#### Enclosure:

413 Aluminum (Polyester powder coated)

#### Pump Head Cover:

413 Aluminum (Polyester powder coated)

#### Cover Screws:

300 Series Stainless Steel

#### DFD System Sensor pins:

Hastelloy C-276

#### Power Cord:

3 conductor, SJTW-A Water-resistant

#### Mounting Brackets and Hardware:

316 Series Stainless Steel

### 3.0 Features

Motor driven diaphragm pump offers smooth and quiet chemical dosing. No hard pulses as seen with solenoid driven pumps.

Full stroke every time avoids vapor lock.

Variable speed DC motor.

Rated for continuous duty (24X7).

PVDF / PTFE / Ceramic pump head components.

Diaphragm Failure Detection (DFD) system. Senses diaphragm failure by detecting chemical in pump head.

Backlit LCD displays motor speed, input signal values, service and alarm status.

CNC precision machined cam and piston for optimum efficiency, unparalleled accuracy, and linearity.

Heavy duty PVDF pump head and valves are standard.

Priming valve built directly into pump head.

Compatible with Blue-White's output Flow Verification Sensor (FVS) system.

### 3.1 Agency Listings



This pump is ETL listed to conform to the following:  
UL Standard 778 as a motor operated water pump  
CSA Standard C22.2 as process control equipment



This pump complies to the Machinery Directive 98/37/EC, BS EN 60204-1, Low Voltage Directive 73/23/EC BS EN 61010-1, EMC Directive 89/336/EC, BS EN 50081-1/BS EN 50082-1.



Symbol	Explanation
	WARNING, risk of electric shock
	CAUTION, refer to users' guide
	GROUND, PROTECTIVE CONDUCTOR TERMINAL

#### Enclosure Rating:

**NEMA 4X:** Constructed for either indoor or outdoor use to provide a degree of protection to personnel against incidental contact with enclosed equipment; to provide a degree of protection against falling dirt, rain, sleet, snow, windblown dust, splashing water, and hose-directed water; and that will be undamaged by external formation of ice on enclosure.

**IP66:** No ingress of dust; complete protection against contact. Water projected in powerful jets against enclosure from any direction shall have no harmful effects.

## 4.0 Installation

<b>CAUTION</b> 	Risk of chemical overdose. Be certain pump does not overdose chemical during backwash and periods of no flow in circulation system.
<b>CAUTION</b> 	Always wear protective clothing, face shield, safety glasses and gloves when working on or near your metering pump. Additional precautions should be taken depending on solution being pumped. Refer to MSDS precautions from your solution supplier.
<b>CAUTION</b> 	All diagrams are strictly for guideline purposes only. Always consult an expert before installing metering pump on specialized systems. Metering pump should be serviced by qualified persons only.

### 4.1 Mounting Location

Choose an area located near chemical supply tank, chemical injection point, and electrical supply. Install pump where it can be easily serviced.

316SS Mounting brackets are included. Mount pump to a secure surface using enclosed mounting hardware.

Mount pump close to injection point. Keep inlet (suction) and outlet (discharge) tubing as short as possible. Longer discharge tubing increases back pressure at pump head.

**Important!** Install a back flow prevention check valve at discharge side of pump to prevent system fluid from flowing back through pump during pump maintenance. **Important!**

A pressure relief valve is recommended at discharge of pump.

### 4.2 Dimensions

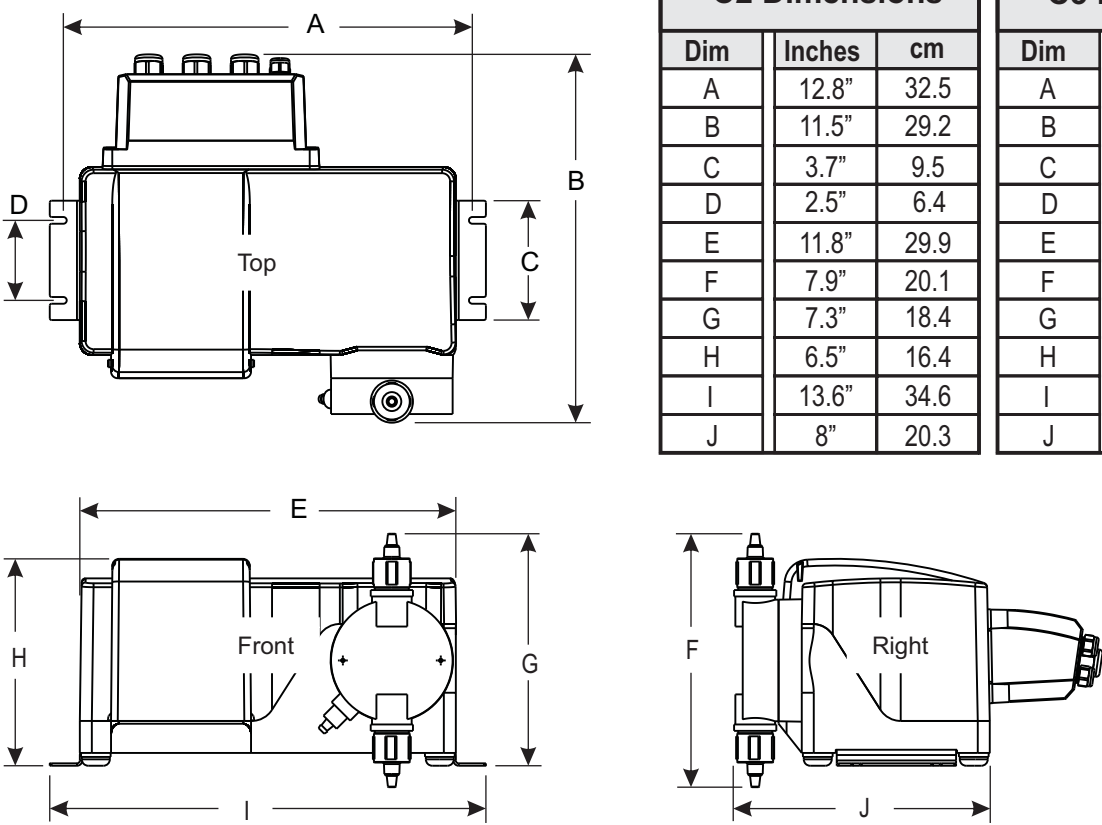

The drawing shows three views of the metering pump: a top view with dimensions A (width), B (height), C (depth), and D (mounting bracket height); a front view with dimensions E (width), F (height), G (total height with bracket), and I (width to center); and a right view with dimensions F (height) and J (width).

C2 Dimensions			C3 Dimensions		
Dim	Inches	cm	Dim	Inches	cm
A	12.8"	32.5	A	14.1"	35.8
B	11.5"	29.2	B	12"	30.5
C	3.7"	9.5	C	3.7"	9.5
D	2.5"	6.4	D	2.5"	6.4
E	11.8"	29.9	E	13.1"	33.2
F	7.9"	20.1	F	9"	22.9
G	7.3"	18.4	G	7.8"	19.8
H	6.5"	16.4	H	6.5"	16.4
I	13.6"	34.6	I	15"	38
J	8"	20.3	J	8"	20.3

**Note:** Optional Extended Bracket adds 4.5" (11.43cm) to overall height (dimension G and H). See page 3 for details.

### 4.3 Installing Injection Fitting and Strainer

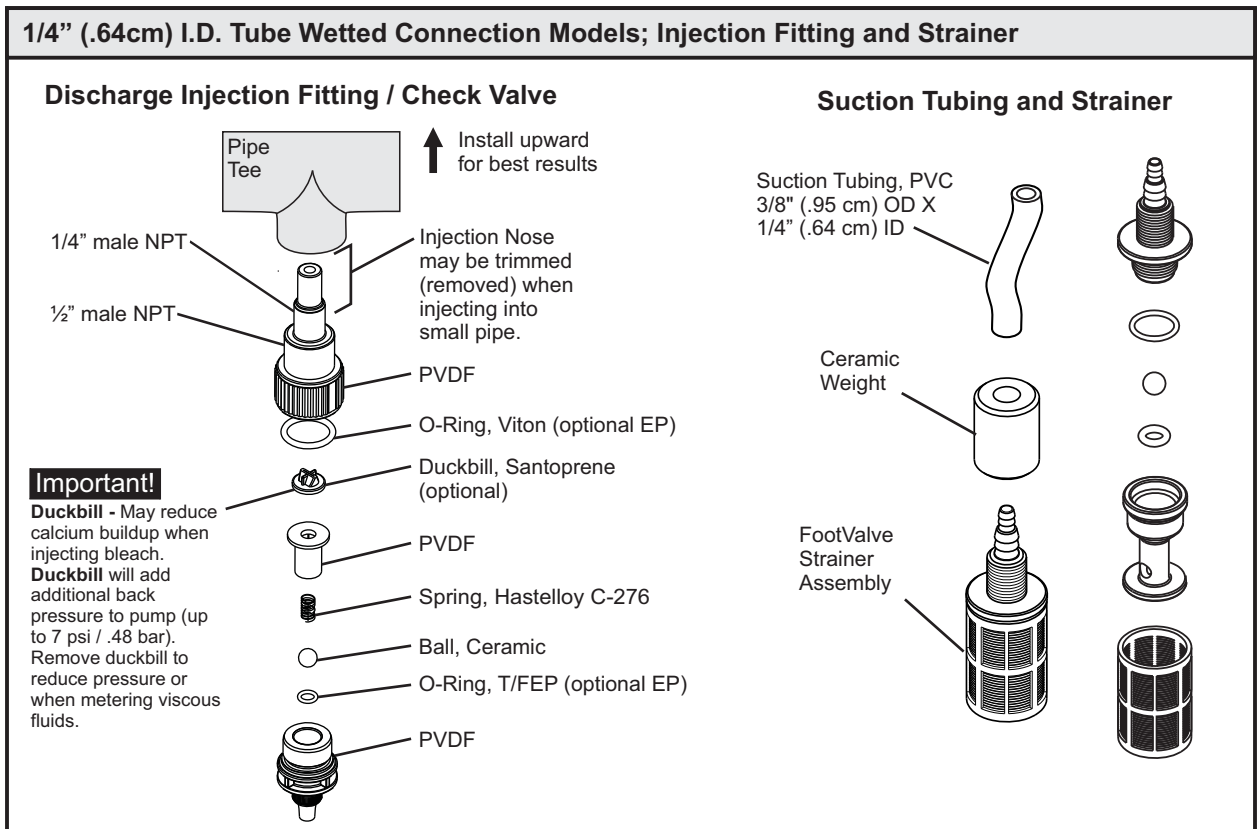
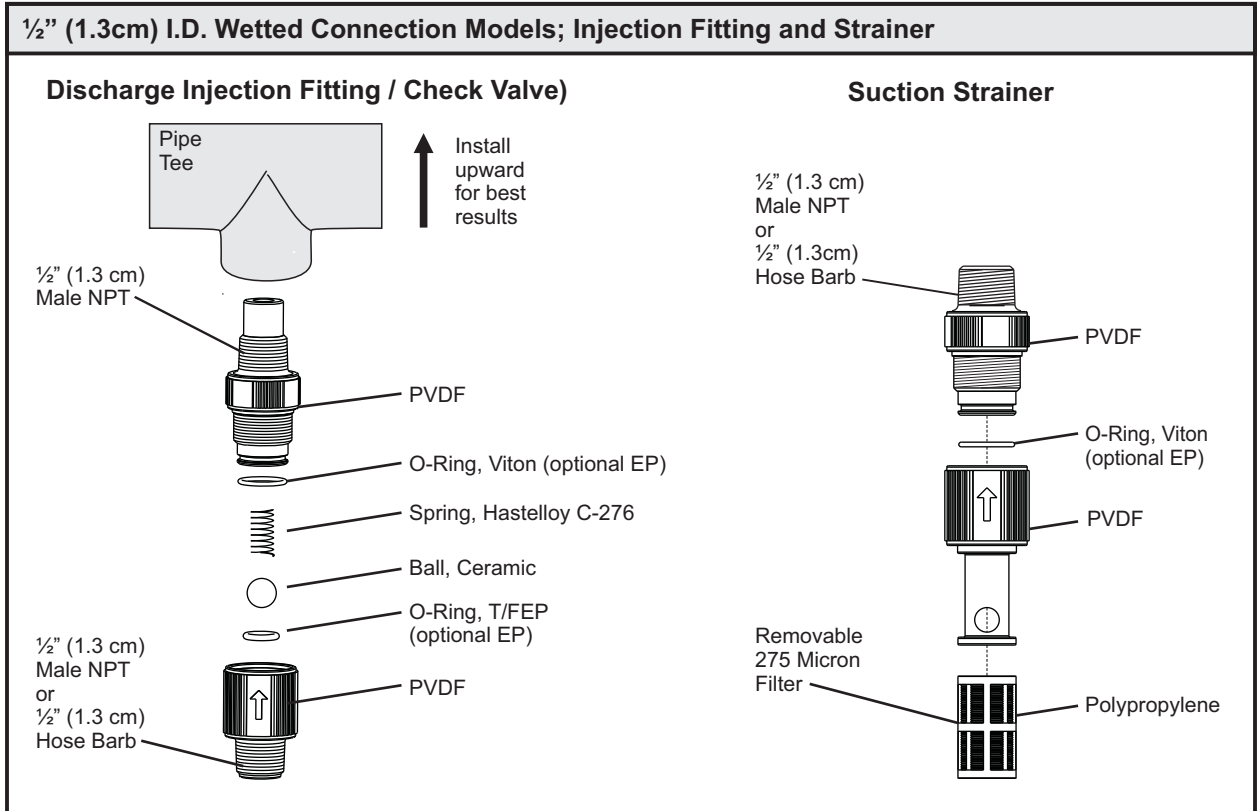

**CAUTION** Proper eye and skin protection must be worn when installing and servicing pump.

**CAUTION** This Pump Has Been Evaluated for Use with Water Only.





## 5.0 Power Connections

<b>WARNING</b> 	Risk of electric shock – cord connected models are supplied with a grounding conductor and grounding-type attachment plug. To reduce risk of electric shock, be certain that it is connected only to a properly grounded, grounding-type receptacle.
<b>WARNING</b> 	Electrical connections and grounding (earthing) must conform to local wiring codes. Be certain that a grounding conductor is connected to terminal T11-1 located in wiring compartment.
<b>WARNING</b> 	Risk of electric shock - Disconnect electricity before removing wiring compartment cover.

Be certain to connect pump to proper supply voltage. Using incorrect voltage will damage pump and may result in injury. Voltage requirement is printed on pump serial label.

Input power: 115VAC 50/60 Hz 1.5 amp or 230/240VAC 50/60 Hz 0.7 amp.

Power switch located in Junction Box.

Use voltage your power cord is rated for.

Cord connected models are supplied with a ground wire conductor and a grounding type attachment plug (power cord). To reduce risk of electric shock, be certain that power cord is connected only to a properly grounded, grounding type receptacle.

Permanently connected models must be properly grounded. Be certain that a grounding conductor is connected to terminal T11-1 located in wiring compartment.

Never strap control (input / output) cables and power cables together.

**Power Interruption:** This pump has an auto-restart feature which will restore pump to operating state it was in when power was lost.

**Note:** When in doubt regarding your electrical installation, contact a licensed electrician.

### WIRING COMPARTMENT COVER

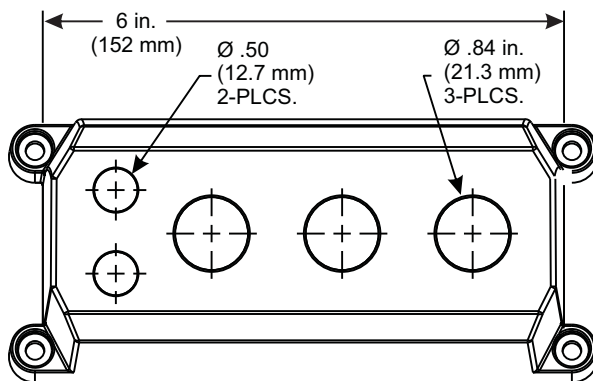

### POWER CORD OPTIONS

Four power cord plug types available.  
Power cord length is 6 feet (3.83 meters)



115V 60Hz  
NEMA 5/15 (USA)  
max: 125V AC

230V 60Hz  
NEMA 6/15 (USA)  
max: 250V AC

240V 50Hz  
CEE 7/VII (EU)  
max: 250V AC

### Included cable and conduit connectors:

QTY.	DESCRIPTION
Qty: 2	.50 Inch (12.7 Mm) Liq-tight Hole Plugs (mat'l = Neoprene), Pre-installed
Qty: 3	.875 Inch (22.2 Mm) Liq-tight Hole Plugs (mat'l = Neoprene), 2 Pre-installed
Qty: 2	.50 Inch (12.7 Mm) Liq-tight Connectors For Pass Thru Cords (mat'l = Nylon) Acceptable Cable Diameter .12 To .26 Inch (3.0 To 6.5 Mm), Not Installed
Qty: 3	.875 Inch (22.2 Mm) Liq-tight Connectors For Pass Thru Cords (mat'l = Nylon) Acceptable Cable Diameter .20 To .40 Inch (5.1 To =10.0 Mm), 1 Pre-installed W/ Power Cord Models
Qty: 2	Metallic Liq-tight Connectors For .50 Inch Flexible Conduit (mat'l = Die Cast Zinc), Not Installed



### 5.1 Wiring Terminals and I/O Schematics

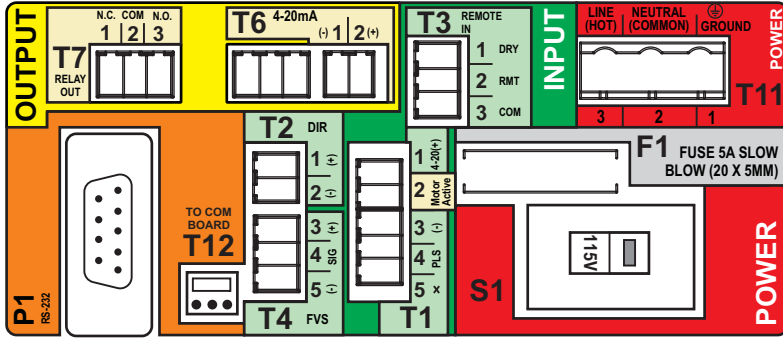

**WARNING** Risk of electric shock - All wiring must be insulated and rated 300V minimum.

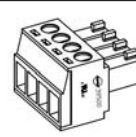

Terminals T1 Thru T8 Plug type 16 - 24 AWG

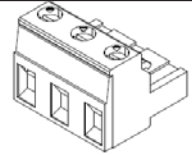

Power Input Terminal T11 Plug type 14 - 30 AWG

Shielded cables should be used on all input signal wires.

FUNCTION	TERM	PIN #	RATING	ELECTRICAL SP.	BLOCK DIAGRAM
INPUT: 4-20 mA	T1	1	(+) POSITIVE	120 OHM IMPEDANCE, NON POWERED LOOP	<p>Single or dual pump (series) input. Loop voltage must not exceed 24 Volts.</p> <p>ACTIVE 4-20mA TRANSMITTER SOURCE</p>
	T1	3	(-) NEGATIVE		
INPUT: FREQUENCY, AC SINE WAVE, TTL, CMOS	T1	3	(-) NEGATIVE	0-1000 HZ MAX.	<p>FREQUENCY TRANSMITTER SOURCE</p>
	T1	4	(+) POSITIVE		
INPUT: FVS SYSTEM (FLOW VERIFICATION SENSOR) FV SENSOR ONLY	T4	3	(+) POSITIVE		
	T4	4	SIGNAL		
	T4	5	(-) NEGATIVE		
INPUT: FVS SYSTEM (FLOW VERIFICATION SENSOR) FS or FP MICRO-FLO FLOW METER ONLY	T4	4	SIGNAL		
	T4	5	(-) NEGATIVE		
	T4	5	(-) NEGATIVE		
INPUT: REMOTE START / STOP (DRY CONTACT C.)	T3	1	(+) POSITIVE	NO VOLTAGE	<p>NOTE: USE ONLY DRY CONTACT FOR REMOTE S/S WHEN USING 4-20mA INPUT</p>
	T3	2	(-) NEGATIVE		
INPUT: REMOTE START / STOP (WET CONTACT C.)	T3	2	(+) POSITIVE	6 TO 30 VOLT DC 1 AMP MAX.	
	T3	3	(-) NEGATIVE		
OUTPUT: 4-20 mA	T6	2	(+) POSITIVE	120 OHM RESISTANCE ACTIVE LOOP	<p>4-20mA RECEIVER 600 OHM LOAD MAX.</p>
	T6	1	(-) NEGATIVE		
OUTPUT: RELAY, 3 AMP	T7	1	NORM. CLOSED	Form C 3 AMP MAX AT 250 VAC, 3 AMP MAX AT 30 VOLT DC	
	T7	2	COMMON		
	T7	3	NORM. OPEN		
OUTPUT: OPEN COLLECTOR MOTOR ACTIVE	T1	2	SIGNAL	5 TO 24 VDC	<p>CLOSED WHILE MOTOR IS ENERGIZED</p>
	T1	3	COMMON		
INPUT: POWER	T11	1	GROUND	115V OR 230V AC MANUAL SWITCH 50 / 60 HZ 100W	
	T11	2	NEUTRAL		
	T11	3	LINE (HOT)		
FUSE	F1	N/A	5 AMP	5A SLOW BLOW (20 X 5MM)	

## 6.0 How to Operate Chem-Pro® - Control Pad



**Press and release**  
To select Run Mode

- Mode 1: Manual
- Mode 2: 4-20mA input
- Mode 3: Frequency input
- Mode 4: Pulse / Batch

**Press and Hold**  
To configure selected Mode

- Mode 0: Setup
- Mode 1: Manual
- Mode 2: 4-20mA input
- Mode 3: Frequency input
- Mode 4: Pulse / Batch



**Press and release**  
To prime pump (60 seconds) --See page 27





**Press and release**  
Press UP arrow to increase pump speed (output) in Manual Operation.  
To increase value while in programming mode.

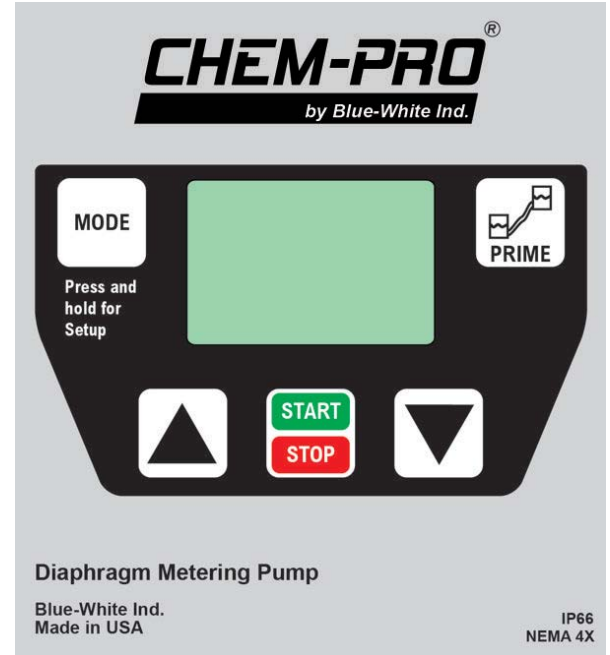

**Press and release**  
To Stop pump at any time.

**Press and release**  
To Start pump.  
To begin listening (reacting) to external signal, such as Remote Start/Stop.

**Press and release**  
Press DOWN arrow to decrease pump speed (output) in Manual Operation.  
To decrease value while in programming mode.



**Press and hold**  
To enter programming mode.

- Remote Start/Stop setup
- FVS (flow verification sensor) setup

**Press and release**  
To save setting while in programming mode.  
To move to **next** selection while in programming mode.

**Time-out** - Chem-Pro® pumps have a time-out setting of approximately 20 seconds while in configuration menu. If built-in timer exceeds 20 seconds without a button being pressed, then pump will exit configuration menu. Changes will automatically be saved if programming mode is allowed to Time-Out.

## 6.1 Mode Descriptions

### Mode 0 - Setup

Press and Hold to configure:

- Remote Start / Stop
- DFD (Diaphragm Failure Detection) sensitivity
- FVS (Flow Verification Sensor) time delay - requires sensor
- 4-20 mA output, available on certain models

Mode 0



### Mode 1 - Manual

Run pump locally by selecting pump speed (1 - 100%).

- Control speed by using up or down arrows after start button is pressed.
- Control speed by entering Mode 1 setup and selecting desired pump speed (1 - 100%)

Mode 1



### Mode 2 - 4-20 mA Input Signal

Run pump remotely via external 4-20 mA signal.

- Press and Hold "MODE" button with Mode 2 selected to configure settings.
- Select Mode 2 and press START button to allow pump to be controlled by external 4-20mA signal.

Mode 2

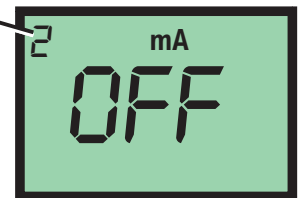

### Mode 3 - Frequency (Hz) Input Signal

Run pump remotely via external high frequency (Hz) signal.

- Press and Hold "MODE" button with Mode 3 selected to configure settings.
- Select Mode 3 and press START button to allow pump to be controlled by external frequency (Hz) signal.

Mode 3



### Mode 4 - Pulse Batch Input Signal (low speed pulse)

Run pump remotely via external low speed pulse signal.

- Press and Hold "MODE" button with Mode 4 selected to configure settings.
- Select Mode 4 and press START button to allow pump to be controlled by external low speed pulse signal.

Mode 4

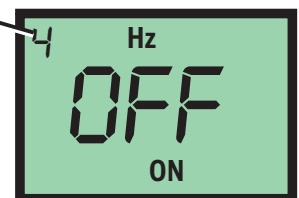

## 7.0 Mode 0 - Set Remote Start / Stop

Used to remotely start and stop pump using a dry contact closure signal.  
When activated; CLOSE = START and OPEN = STOP.

Set to NO = Remote Start / Stop is disabled  
Set to Yes = Remote Start / Stop is enabled

Can be used with external foot pedal, PLC, contact closure or other similar external devices.

Default setting = No (disabled)

### Step 1

Ensure pump is stopped and LCD reads "OFF."

Note: Mode cannot be changed while pump is in running.

Press and release STOP button if pump is running.

Press and release MODE button multiple times until Mode 0 is selected.

Mode 0



### Step 2

With Mode 0 selected, press and hold MODE button until 'Remote' icon begins flashing.

Default setting 'NO' will also be visible when entering remote start / stop setup.

Note: If 'YES' had been selected previously, then 'YES' will be displayed on screen.

Mode 0

Remote  
Icon



### Step 3

Press and release DOWN arrow to change setting to 'YES.'

To change setting back to 'NO' press and release UP arrow.

Mode 0



### Step 4

After you've made your selection, press and release MODE button. This saves your setting.

You can now modify other settings in Mode 0 or you can exit Setup by pressing and holding MODE button for a few seconds until you return to Run screen.

Mode 0



Running pump with Remote Start / Stop enabled, 'REMOTE' icon will always be visible on lower left side of screen. Pump will display 'STBY' (standby) if pump is in stop mode via contact closure signal. **Please use caution in this mode, pump can start at anytime. If you must perform maintenance to pump, press and release STOP button.**

## 7.1 Mode 0 - Set TFD Sensitivity

Chem-Pro pump is equipped with a Diaphragm Failure Detection (DFD) system which is designed to stop pump in event diaphragm should rupture and chemical enters pump head. This system is capable of detection presence of a large number of chemicals including Sodium Hypochlorite (chlorine), Hydrochloric (muriatic) Acid, Sodium Hydroxide, and many others.

Minimum and Maximum setting = 75 % to 100%

Default Setting = 75% (75% is recommended; triggers with most water treatment chemicals without false alarms)

Important: 100% sensitivity setting may trigger false alarm by washdown or rain. 100% setting is only recommended when absolutely necessary.

### Step 1

Ensure pump is stopped and LCD reads "OFF."

Note: Mode cannot be changed while pump is in running.

Press and release STOP button if pump is running.

Press and release MODE button multiple times until Mode 0 is selected.

Mode 0



### Step 2

With Mode 0 selected, press and hold MODE button until 'Remote' icon begins flashing.

This indicates that you've entered Setup menu.

Mode 0

Remote  
Icon



### Step 3

Press and release MODE button to scroll through menu until you see DFD icon.

If you pass DFD screen, continue to press and release MODE button until TFD icon appears.

Mode 0



### Step 4

DFD icon will appear for 1 second, followed by numbers. Numbers indicate sensitivity value of DFD.

Press and release UP arrow button to increase sensitivity value.

Press and release DOWN arrow button to decrease sensitivity value.

Mode 0



### Step 5

After you've made your selection, press and release MODE button. This saves your setting.

You can now modify other settings in Mode 0 or you can exit Setup by; press and hold MODE button for a few seconds until you return to Run screen.

Mode 0



## 7.2 Mode 0 - Set FVS (flow verification system)

Flow verification sensor sold separately.

Flow verification system is designed to stop pump in an event sensor does not detect flow during pump operation. Indicating an empty chemical tank, clogged injection fitting, loose tubing connection, etc.

To allow pump to clear any gasses that may have accumulated over time, an alarm delay time value from 1 to 255 seconds must be programmed.

Note: An alarm delay of 000 seconds disables FVS system.

### Step 1

Ensure pump is stopped and LCD reads "OFF."

Note: Mode cannot be changed while pump is in running.

Press and release STOP button if pump is running.

Press and release MODE button multiple times until Mode 0 is selected.

Mode 0



### Step 2

With Mode 0 selected, press and hold MODE button until 'Remote' icon begins flashing.

This indicates that you've entered Setup menu.

Mode 0

Remote  
Icon



### Step 3

Press and release MODE button to scroll through menu until you see FVS icon.

If you pass FVS screen, continue to press and release MODE button until FVS icon appears.

Mode 0



### Step 4

FVS icon will appear for 1 second, followed by numbers.

These numbers indicate delay time setting for FVS.

Select a delay time in seconds. Delay time is amount of time pump will wait to receive a pulse from sensor until an alarm it triggered.

A delay time of 00 deactivates FVS feature.

Mode 0



### Step 5

After you've made your selection, press and release MODE button. This saves your setting.

You can now modify other settings in Mode 0 or you can exit Setup by; press and hold MODE button for a few seconds until you return to Run screen.

Mode 0



**Time-out** - Chem-Pro® pumps have a time-out setting of approximately 20 seconds while in configuration menu. If built-in timer exceeds 20 seconds without a button being pressed, then pump will exit configuration menu. Changes will automatically be saved if programming mode is allowed to Time-Out.

## 7.2 Mode 0 - Set FVS (flow verification system) - Continued

Flow Verification Sensor is designed to give you two installation options.

Sensor can be installed:

- Directly onto pump head of Chem-Pro® pump, discharge side.
- Anywhere on discharge side of Chem-Pro® pump.

Wiring for sensor can be connected directly to a Chem-Pro® pump. Pump will stop pumping if sensor detects no flow. A relay will then close allowing for remote alarm indication or initiation of a back-up pump. **Install FVS Flow Sensor** - Flow Verification Sensor should be installed on inlet (suction) side of pump tube.

When installing directly onto pump 3/8" tube discharge fitting:

Sensor includes a PVC tubing insert, located inside sensors female thread connection, that is designed to seal sensor onto pump tube adapter. Thread sensor onto pump tube until tubing insert is snug against pump tube fitting - do not over-tighten.

Sensor Model Number	Published Flow Range	Actual Working Range with Chem-Pro® Pump
	ML/Min	ML/Min
FV-100	30-300	30-200
FV-200	100-1000	50-900
FV-300	200-2000	100-1800
FV-400	300-3000	300-3000
FV-500	500-5000	500-5000
FV-600	700-7000	700-7000

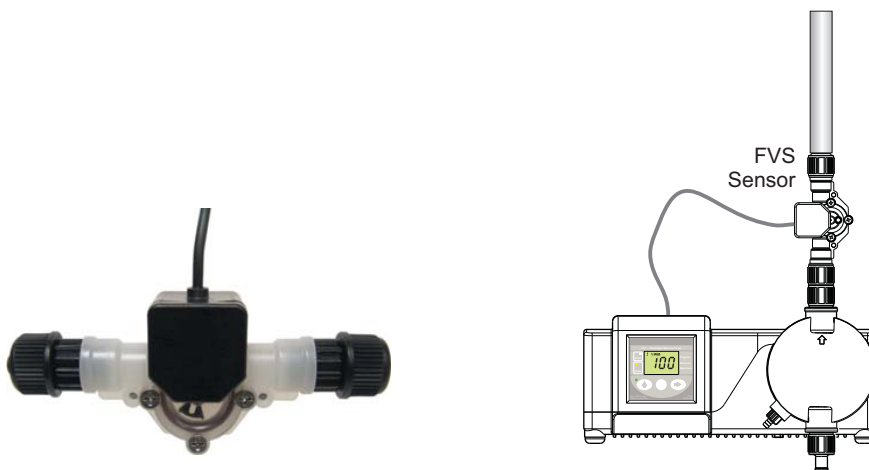

**Confirm FVS flow range** - Flow Verification Sensor (FVS) will only function within its operating range. See chart for available ranges.

NOTE: If pump output is less than 30 ml/min, sensor will not detect chemical and a signal will not be sent to pump, resulting in an alarm condition.

NOTE: For low viscosity (water-like) fluids only. Consult factory if attempting to use with viscous fluids.



## 7.3 Mode 0 - Set 4-20mA Output

Available on certain models.

Sends a configurable 4-20 mA signal, based on pump rotor speed, to an external device. This feature can be used to control other pumps (in sync / proportionally), data logging systems, and other external devices for plant automation.

Default setting: Minimum Speed = 4 mA signal output  
Maximum Speed = 20 mA signal output

Set to NO = disabled

Set to Yes = enabled

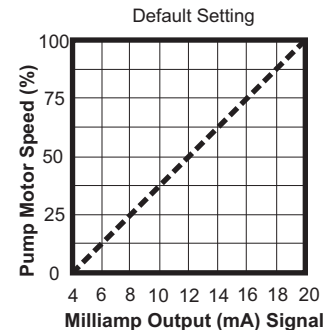

### Step 1

Ensure pump is stopped and LCD reads "OFF."

Note: Mode cannot be changed while pump is in running.

Press and release STOP button if pump is running.

Press and release MODE button multiple times until Mode 0 is selected.

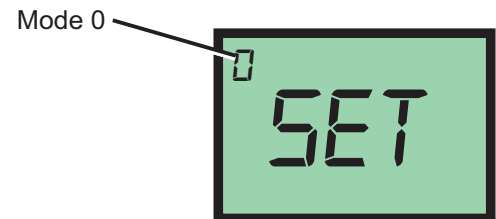

### Step 2

With Mode 0 selected, press and hold MODE button until 'Remote' icon begins flashing.

This indicates that you've entered Setup menu.

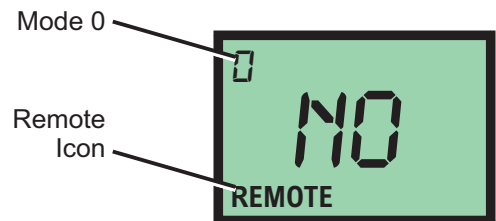

### Step 3

Press and release MODE button to scroll through menu until you see 4-20 mA icon.

To select Yes, press and release DOWN arrow.

To select No, press and release UP arrow.

To begin configuring values, select Yes.

Then press and release MODE button.

*Only available on certain models*

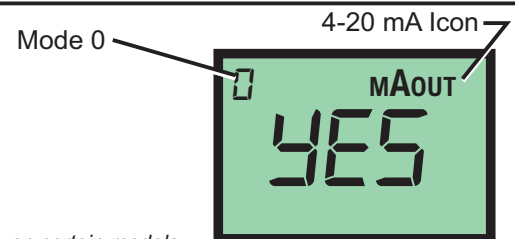

### Step 4

**Minimum pump speed** will be displayed.

To increase value, press and release UP arrow.

To decrease value, press and release DOWN arrow.

To save value, press and release MODE button.

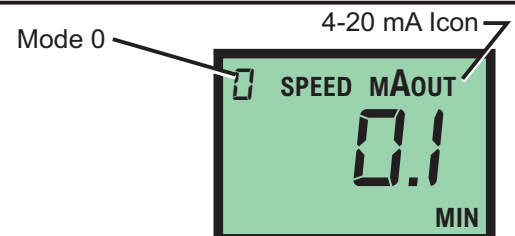

**Time-out** - Chem-Pro® pumps have a time-out setting of approximately 20 seconds while in configuration menu. If built-in timer exceeds 20 seconds without a button being pressed, then pump will exit configuration menu. Changes will automatically be saved if programming mode is allowed to Time-Out.

### 7.3 Mode 0 - Set 4-20mA Output - Continued

#### Step 5

**Output signal at minimum speed** will now be displayed.  
 To increase value, press and release UP arrow.  
 To decrease value, press and release DOWN arrow.  
 To save value, press and release MODE button.

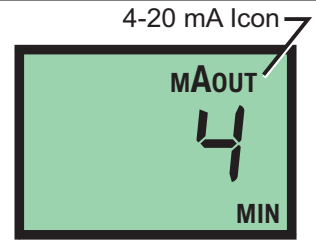

#### Step 6

**Maximum pump speed** will be displayed.  
 To increase value, press and release UP arrow.  
 To decrease value, press and release DOWN arrow.  
 To save value, press and release MODE button.

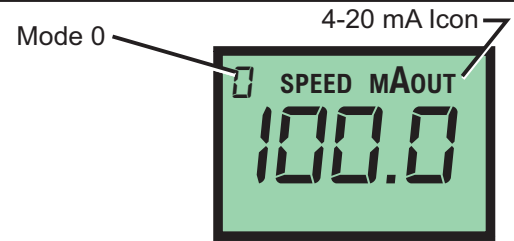

#### Step 7

**Output signal at maximum speed** will now be displayed.  
 To increase value, press and release UP arrow.  
 To decrease value, press and release DOWN arrow.  
 To save value, press and release MODE button.

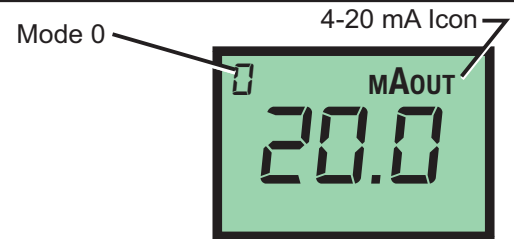

#### Step 8

You can now modify other settings in Mode 0 or you can exit Setup by; press and hold MODE button for a few seconds until you return to Run screen.

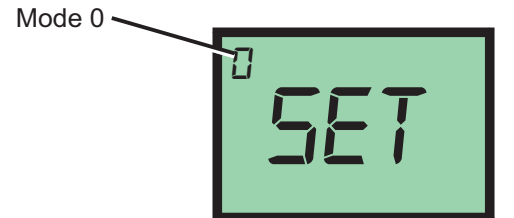

#### Example 1

0% Pump Output = 4 mA  
 100 % Pump Output = 20 mA

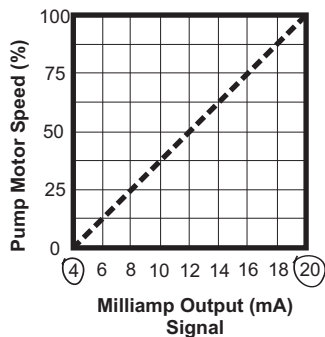

#### Example 2

0% Pump Output = 4 mA  
 50% Pump Output = 16 mA

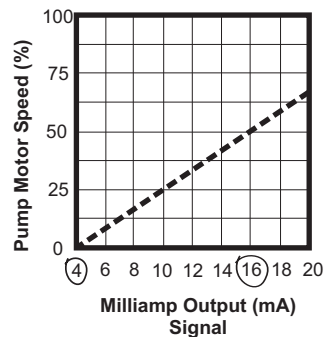

## 8.0 Mode 1 - Manual Operation

Used to manually control speed of pump.

Use UP and DOWN arrows to adjust speed while pump is running.

To select exact run speed, follow steps below.

### Step 1

Ensure pump is stopped and LCD reads "OFF."

Note: Mode cannot be changed while pump is in running.

Press and release STOP button if pump is running.

Press and release MODE button multiple times until Mode 1 is selected.

Mode 1



### Step 2

With Mode 1 selected, press and hold MODE button until 'Speed' icon begins flashing.

This indicates that you've entered Setup menu.

Mode 1



### Step 3

**Current pump speed** will be displayed.

To increase value, press and release UP arrow.

To decrease value, press and release DOWN arrow.

To save value, press and hold MODE button until 'Speed' icon stop flashing.

Mode 1

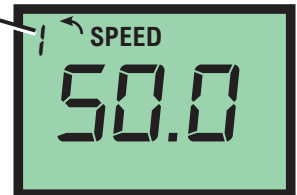

### Step 4

Pump will now operate at your pre-configured speed.

Press and release START button to start pump.

Press and release STOP button at anytime to stop pump.

Mode 1

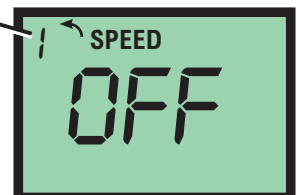

With pump operating in manual mode (Mode 1), pump speed can be changed at anytime by using UP or DOWN arrows during operation.

## 8.1 Mode 1 - Manual Operation Screen Shots

### Runtime Screen Shot 1

Display motor speed percentage.  
Pump Running in Manual Operation



### Runtime Screen Shot 2

Display 4-20mA output (select models only)  
Press and release MODE button to view mA output value  
in real-time.

**Please note:** 4-20mA output is only available on select models. If included in  
your model; 4-20mA output must be enabled in Mode 0 (see page 16).

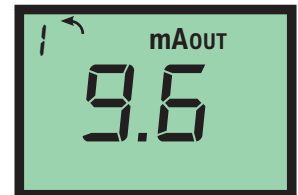

### Runtime Screen Shot 3

Display motor speed percentage.  
Press and release MODE button to view percentage of  
motor speed.



## 9.0 Mode 2 - 4-20mA Input Operation

Used to remotely control pump with an incoming 4-20 mA signal.

Default setting: 4 mA signal = 0.1% motor speed  
20 mA signal = 100.0% motor speed

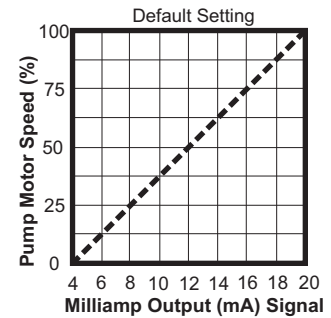

### Step 1

Ensure pump is stopped and LCD reads "OFF."

Note: Mode cannot be changed while pump is in running.

Press and release STOP button if pump is running.

Press and release MODE button multiple times until Mode 2 is selected.

Mode 2



### Step 2

With Mode 2 selected, press and hold MODE button until 'Speed' icon begins flashing.

This indicates that you've entered Setup menu.

Mode 2

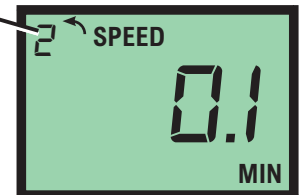

### Step 3

**Minimum pump speed** will be displayed.

To increase value, press and release UP arrow.

To decrease value, press and release DOWN arrow.

To save value, press and release MODE button.

Mode 2

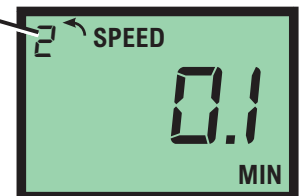

### Step 4

**mA value linked to minimum pump speed** will be displayed.

To increase value, press and release UP arrow.

To decrease value, press and release DOWN arrow.

To save value, press and release MODE button.

Mode 2

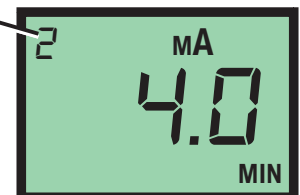

### Step 5

**Maximum pump speed** will be displayed.

To increase value, press and release UP arrow.

To decrease value, press and release DOWN arrow.

To save value, press and release MODE button.

Mode 2

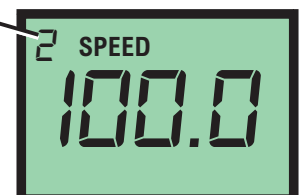

**Time-out** - Chem-Pro® pumps have a time-out setting of approximately 20 seconds while in configuration menu. If built-in timer exceeds 20 seconds without a button being pressed, then pump will exit configuration menu. Changes will automatically be saved if programming mode is allowed to Time-Out.

## 9.0 Mode 2 - 4-20mA Input Operation - Continued

### Step 6

**mA value linked to minimum pump speed** will now be displayed.

To increase value, press and release UP arrow.

To decrease value, press and release DOWN arrow.

To save value, press and release MODE button.

Mode 2

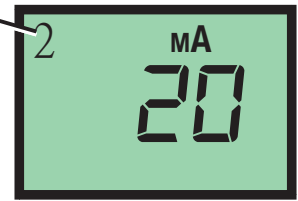

### Step 7

To exit Setup, press and hold MODE button for a few seconds until you return to Run screen.

Mode 2

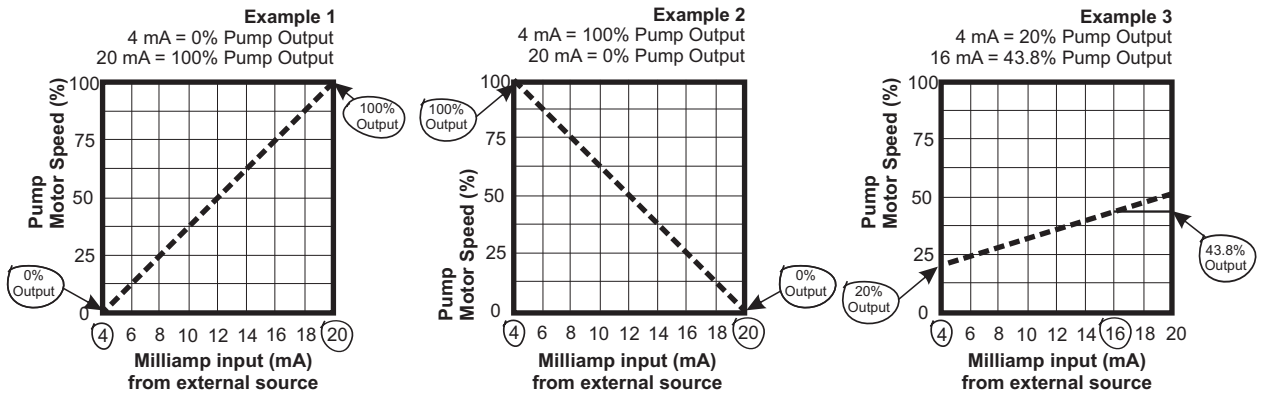
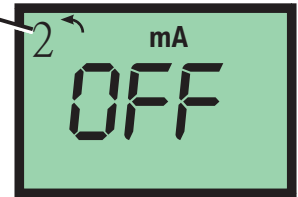

## 9.1 Mode 2 - 4-20mA Input Screen Shots

### Runtime Screen Shot 1

Display **motor speed percentage**.  
Pump Running in 4-20mA Input Operation

Mode 2

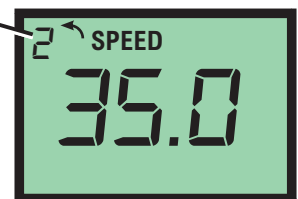

### Runtime Screen Shot 2

Display current 4-20mA input signal  
Press and release MODE button to view **mA input** value in real-time.

Mode 2

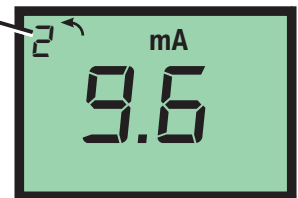

*Only available on certain models*

### Runtime Screen Shot 3

Press and release MODE button again to view **mA output** value in real-time (available on select models only).  
Press and release MODE button again to view **motor speed percentage**, as in Screen Shot 1.

Mode 2

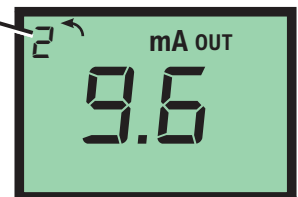

## 10.0 Mode 3 - Frequency Input (Hz) Operation

Used to remotely control pump with an incoming high speed frequency signal. Typically used with flow meters or other external devices.

Default setting: 0 Frequency (Hz) = 0% motor speed  
1000 Frequency (Hz) = 100% motor speed

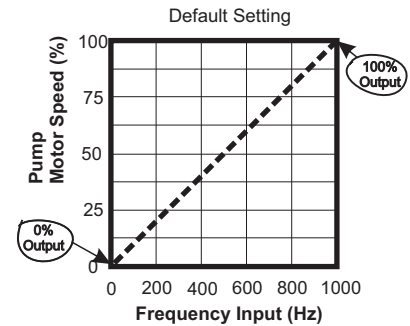

### Step 1

Ensure pump is stopped and LCD reads "OFF."

Note: Mode cannot be changed while pump is in running.

Press and release STOP button if pump is running.

Press and release MODE button multiple times until Mode 3 is selected.

Mode 3



### Step 2

With Mode 3 selected, press and hold MODE button until 'Speed' icon begins flashing.

This indicates that you've entered Setup menu.

Mode 3

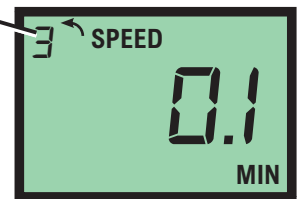

### Step 3

**Pump speed at minimum Frequency** will be displayed.

To increase value, press and release UP arrow.

To decrease value, press and release DOWN arrow.

To save value, press and release MODE button.

Mode 3

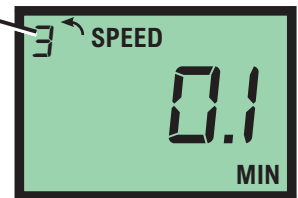

### Step 4

**Minimum Frequency (Hz) value** will be displayed.

To increase value, press and release UP arrow.

To decrease value, press and release DOWN arrow.

To save value, press and release MODE button.

Mode 3

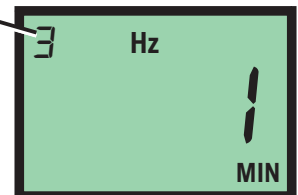

**Time-out** - Chem-Pro® pumps have a time-out setting of approximately 20 seconds while in configuration menu. If built-in timer exceeds 20 seconds without a button being pressed, then pump will exit configuration menu. Changes will automatically be saved if programming mode is allowed to Time-Out.



### 10.0 Mode 3 - Frequency Input (Hz) Operation - Continued

**Step 5**

**Pump speed at maximum Frequency** will be displayed.  
 To increase value, press and release UP arrow.  
 To decrease value, press and release DOWN arrow.  
 To save value, press and release MODE button.

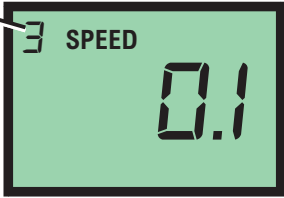

Mode 3

**Step 6**

**Maximum Frequency value** will now be displayed.  
 To increase value, press and release UP arrow.  
 To decrease value, press and release DOWN arrow.  
 To save value, press and release MODE button.



Mode 3

**Step 7**

To exit Setup, press and hold MODE button for a few seconds until you return to Run screen.



Mode 3

Examples:

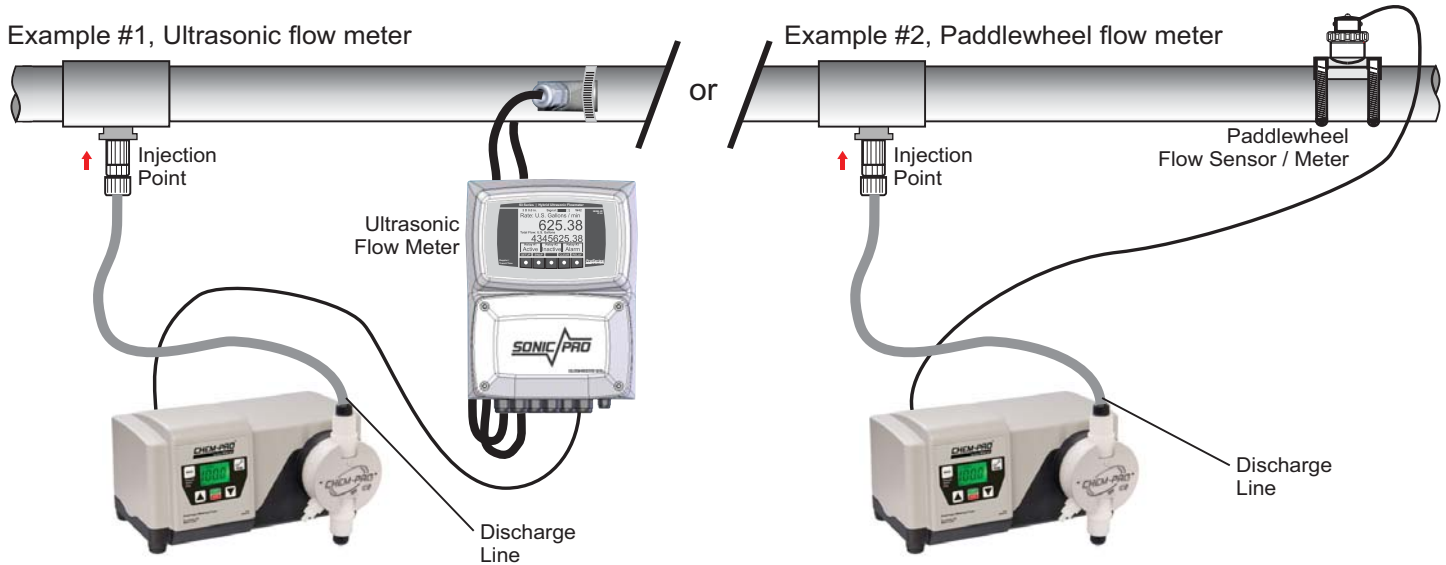
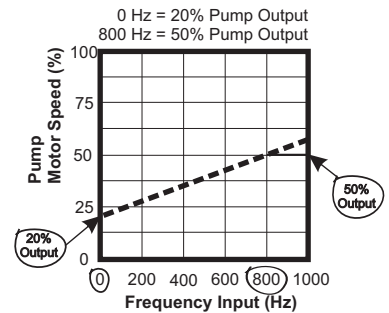
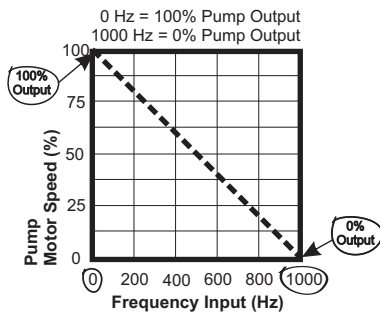
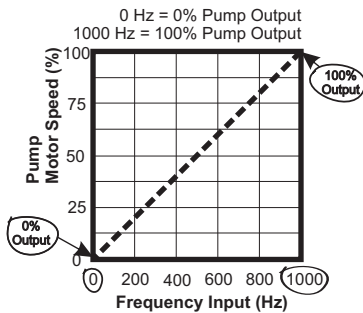

## 11.0 Mode 4 - Pulse Batch (low speed pulse) Operation

Used to remotely control pump with an incoming pulse signal. Can be used with an external foot pedal, a water meter, a PLC, contact closure, or other low speed pulse devices.

Default setting: 1 Pulse = 100% motor speed for 2.5 seconds

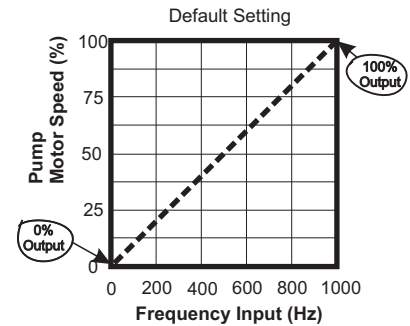

### Step 1

Ensure pump is stopped and LCD reads "OFF."

Note: Mode cannot be changed while pump is in running.

Press and release STOP button if pump is running.

Press and release MODE button multiple times until Mode 2 is selected.

Mode 4

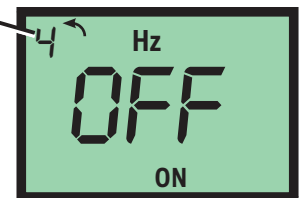

### Step 2

With Mode 4 selected, press and hold MODE button until 'On' icon begins flashing.

This indicates that you've entered Setup menu.

Mode 4



### Step 3

**Pump on-time** will be displayed in either MIN (minutes) or SEC (seconds).

To increase value, press and release UP arrow.

To decrease value, press and release DOWN arrow.

To save value, press and release MODE button.

Mode 4



### Step 4

**MIN (minutes) or SEC (seconds)** will be displayed in lower right hand corner. This value will be linked to Pump on-time number in previous screen.

To change this setting, press and release either UP arrow or DOWN arrow.

To save value, press and release MODE button.

Mode 4

MIN or SEC

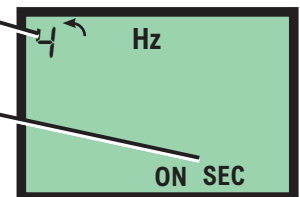

**Time-out** - Chem-Pro® pumps have a time-out setting of approximately 20 seconds while in configuration menu. If built-in timer exceeds 20 seconds without a button being pressed, then pump will exit configuration menu. Changes will automatically be saved if programming mode is allowed to Time-Out.

## 11.0 Mode 4 - Pulse Batch (low speed pulse) Operation - Continued

### Step 5

**Number of pulses to trigger pump start** will be displayed.  
To increase value, press and release UP arrow.  
To decrease value, press and release DOWN arrow.  
To save value, press and release MODE button.

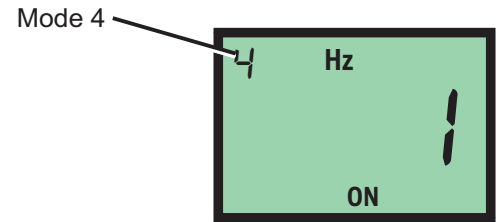

### Step 6

**Pump speed during on-time** will now be displayed.  
Pump will run at this speed after selected number of pulses is reached from previous menu.  
To increase value, press and release UP arrow.  
To decrease value, press and release DOWN arrow.  
To save value, press and release MODE button.

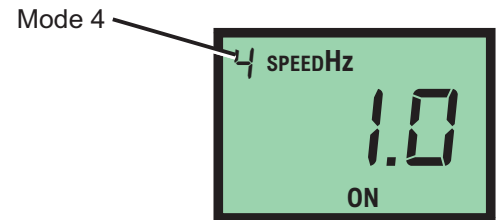

### Step 7

To exit Setup, press and hold MODE button for a few seconds until you return to Run screen.

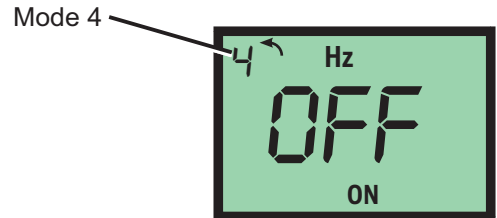

## 11.1 Mode 4 - Pulse Batch Operation Screen Shots

### Runtime Screen Shot 1

Display **motor speed percentage**.  
Pump Running in Pulse Batch Operation

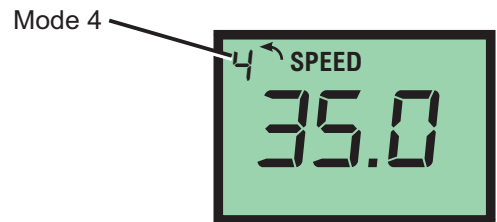

### Runtime Screen Shot 2

Display current number of pulses received  
Press and release MODE button to view number of **pulses received** in real-time.

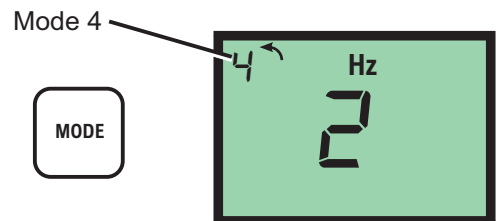

### Runtime Screen Shot 3

Press and release MODE button again to view **mA output** value in real-time (available on select models only).  
Press and release MODE button again to view **motor speed percentage**, as in Screen Shot 1.

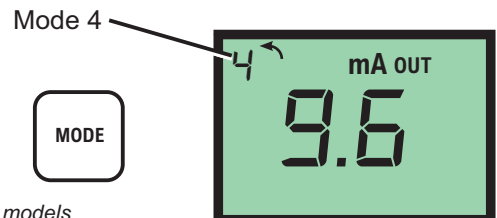

*Only available on certain models*

## 12.0 Alarm Relay

Pump has a built in 3 amp alarm output relay. Relay is pre-configured to energize on diaphragm failure detection (DFD) and on Flow Verification Sensor (FVS).

A Flow Verification Sensor must be installed and configured for relay to trigger on no-flow conditions. See page 9 for wiring details.

## 13.0 Volumetric Test - Calibration

This volumetric test will take into account individual installation factors such as line pressure, fluid viscosity, suction lift, etc. This test is most accurate for measuring injector's output in an individual installation.

1. Be sure Injection Fitting and Footvalve / Strainer are clean and working properly.
2. Fill a large graduated cylinder with solution to be injected.
3. With pump installed under normal operating conditions, place suction tubing with Footvalve / Strainer installed in graduated cylinder.
4. Push 3/8" tubing onto priming valve. Place other side of 3/8" tubing in solution tank. Make sure priming valve is closed by turning valve to right.
5. Run pump until all air is removed from suction line and solution enters discharge tubing.  
If pump does not easily prime, loosen priming valve 1 - 2 turns counter clock wise. Once air is removed close priming valve.
6. Remove suction tubing from graduated cylinder and refill graduated cylinder if necessary. Note amount of solution in graduated cylinder.
7. Place suction tubing with Footvalve / Strainer installed back into graduated cylinder.
8. Run injector for a measured amount of time. A longer testing time will produce more accurate results.
9. Remove suction tubing from graduated cylinder. Measure amount of chemical injected.

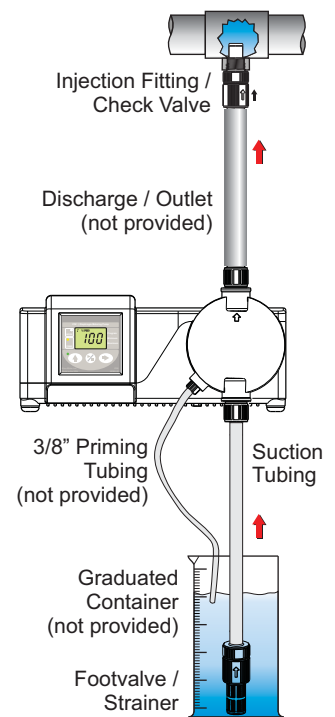

### Example:

During your 1 minute calibration period, say Chem-Pro pumped 1000 Milliliters in 1 minute.

$$1 \text{ US Gallon} = 3.785 \text{ Liters} = 3785 \text{ Milliliters}$$

$$\left( \frac{1000 \text{ ML/Min}}{3785} \right) 60 = 15.85 \text{ GPH (US gallons per hour)}$$

Minutes per hour

Milliliters in a US gallon

**Note:** All diagrams are strictly for guideline purposes only. Always consult an expert before installing pump into specialized systems. Pump should be **serviced by qualified persons only.**

## 14.0 Priming Pump

Priming is an essential part of proper pump functionality. It ensures pump head is devoid of air or gas. Fluid will escape from Priming/Degassing valve during priming so it is recommended that you attach tubing to barbed fitting and place opposite end in chemical tank.

1. Start by attaching 3/8" OD (1/4" ID) suction tubing to barbed fitting of priming/degassing valve.
2. Open valve by rotating it counter clockwise one quarter to one half turn.
3. Once valve is open, attach 3/8" OD (1/4" ID) suction tubing to barbed fitting and place opposite end of tubing into chemical tank.
4. Press and release prime button. Pump will then run for 60 seconds at 100% motor speed, evacuating air/gas from inside pump head.
5. Rotate priming/degassing valve clockwise to close.

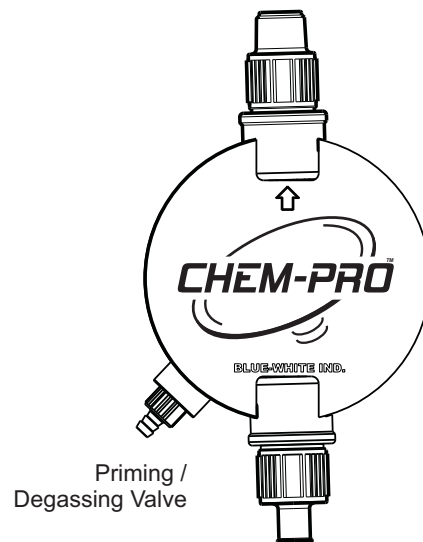

## 15.0 Pump Maintenance

<b>CAUTION</b> ⚠	Prior to service, pump clean water through pump and suction / discharge line to remove chemical.
<b>CAUTION</b> ⚠	Always wear protective clothing, face shield, safety glasses and gloves when working on or near your metering pump. Additional precautions should be taken depending on solution being pumped. Refer to MSDS precautions from your solution supplier.

### 15.1 Routine Inspection and Maintenance

Pump requires very little maintenance. However, pump and all accessories should be checked weekly. This is especially important when pumping chemicals. Inspect all components for signs of leaking, swelling, cracking, discoloration or corrosion. Replace worn or damaged components immediately.

Cracking, crazing, discoloration during first week of operation are signs of severe chemical attack. If this occurs, immediately remove chemical from pump. Determine which parts are being attacked and replace them with parts that have been manufactured using more suitable materials. Manufacturer does not assume responsibility for damage to pump that has been caused by chemical attack.

Brush Kit Life Cycle over 3,000 hours of continuous use at max speed. A spare brush kit is located inside of pump housing.

### 15.2 Cleaning Pump

Pump will require occasional cleaning, especially Injection fitting, Footvalve / Strainer, and pump head valves. Frequency will depend on type and severity of service.

- ☑ Inspect and replace pump head valves as required.
- ☑ When changing diaphragm, pump head chamber and pump head cover should be wiped free of any dirt and debris. The pump stroke must be FORWARD when screwing in the diaphragm and BACKWARD when installing and tightening the pump head.
- ☑ Periodically clean injection / check valve assembly, especially when injecting fluids that calcify such as sodium hypochlorite. These lime deposits and other build ups can clog fitting, increase back pressure and interfere with check valve operation.
- ☑ Periodically clean suction strainer.
- ☑ Periodically inspect pump housing (enclosure) for chemical attack. Protect pump housing from continuous exposure to chemicals, such as drips or fumes from surrounding equipment and plumbing.

## 15.3 Motor Brush Replacement

Brushes wear differently on each side of motor. It is recommended to replace both brushes at the same time.

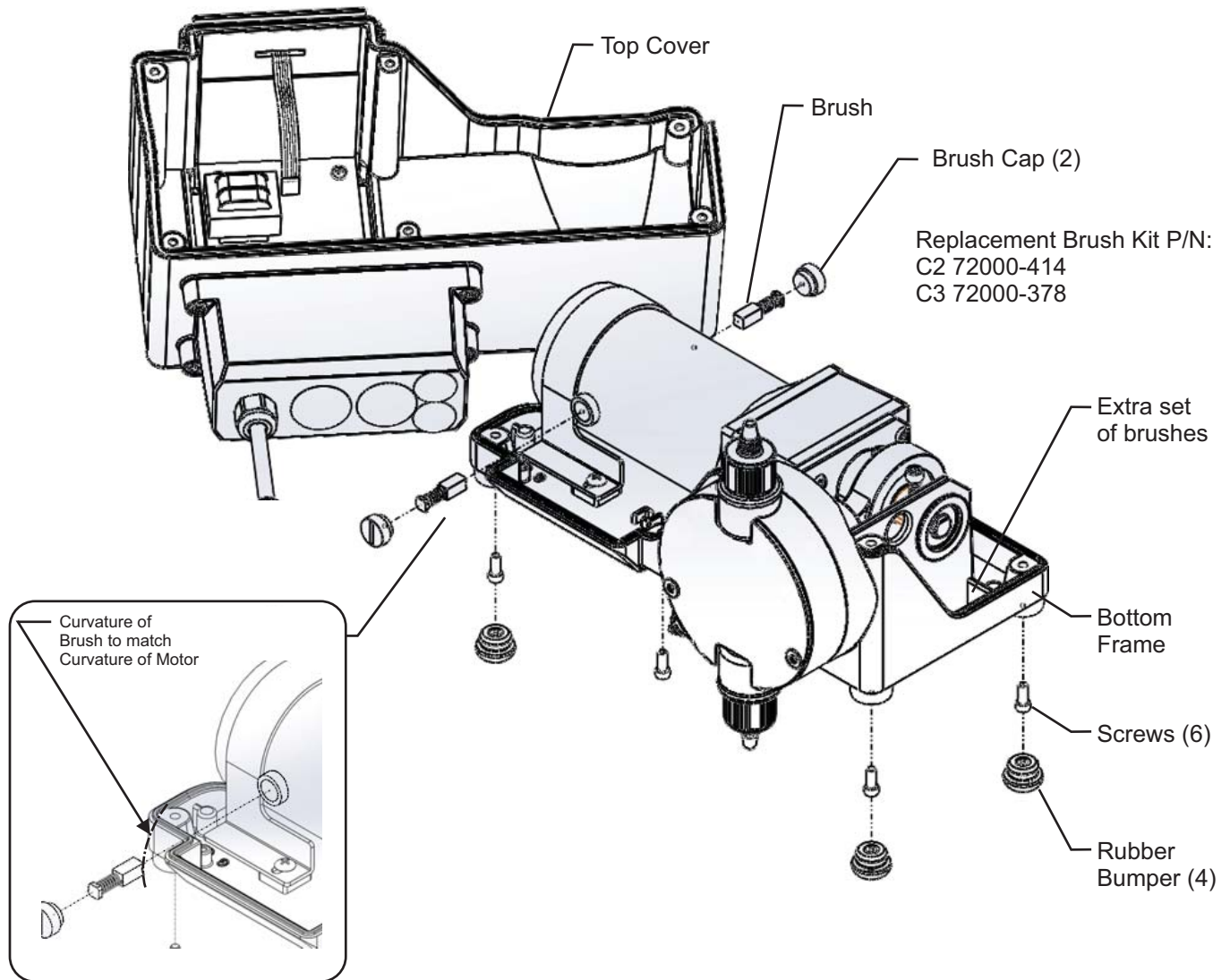

### Step 1

Remove 4 black rubber bumpers from bottom frame.

### Step 2

Remove 6 screws from underneath side of bottom frame.

### Step 4

Lift off top cover from bottom frame carefully. Place top cover close to bottom frame.

*Please Note:* Wires connecting top and bottom may become unplugged if pulled too far apart.

### Step 5

Unscrew and remove brush caps by turning counter-clockwise.

### Step 6

Remove used brushes and discard properly.

### Step 7

Insert new brushes. Be sure to install brushes to that curvature of brush is concentric to curvature of motor. Please note: One extra set of brushes are provided inside frame.

Intentionally left blank



## 16.0 Replacement Parts List

### 16.1 C2 Parts List

ITEM	PART NO.	DESCRIPTION	QTY REQ.
1	90011-081	SCREW 6-32 X .5	2
2	90001-170	COVER P/H C2	1
	90001-171	COVER P/H NO LOGO	1
3	90011-181	SCREW 10X32 X 1.25	8
5	70001-353	PRIME VALVE VITON®	1
	70001-354	PRIME VALVE EP	
6	76200-092	P/HEAD LG C2 KYNAR	1
	76200-093	P/HEAD SM C2 KYNAR	
7	70001-349	VALVE .5 M/NPT VIT	2
	70001-350	VALVE .5 M/NPT EP	
	70001-351	VALVE .5 F/NPT VIT	
	70001-352	VALVE .5 F/NPT EP	
	70001-347	VALVE .5 T-BARB VIT	
	70001-348	VALVE .5 T-BARB EP	
	70001-372	VALVE .375 TUBE VIT	
	70001-373	VALVE .375 TUBE EP	
8	20000-194	KIT 4 EA. VALVE VIT	1
	20000-195	KIT 4 EA. VALVE EP	
9	72000-297	SM DIAPH. KIT C2 KYNAR	1
	72000-296	LG DIAPH. KIT C2 KYNAR	
11	90001-173	P/HEAD LG. SPACER	1
	90001-172	P/HEAD SM. SPACER	
13	90003-561	BUMPER FEET	4
14	90002-326	UV LCD CVR PLYCRB	1
16	71010-027	J-BOX KIT W/ 115V	1
	71010-028	J-BOX KIT W/ 230V	1
	71010-029	J-BOX KIT W/ 220V	1
21	71000-575	FOOTVALVE .5 T CR VIT	1
	71000-447	FTVALVE .5 CR VT/AF NO SP	
	71000-325	FOOTVALVE .5 CR EP NO SP	
22	90008-043	CLAMP SS .5"	1

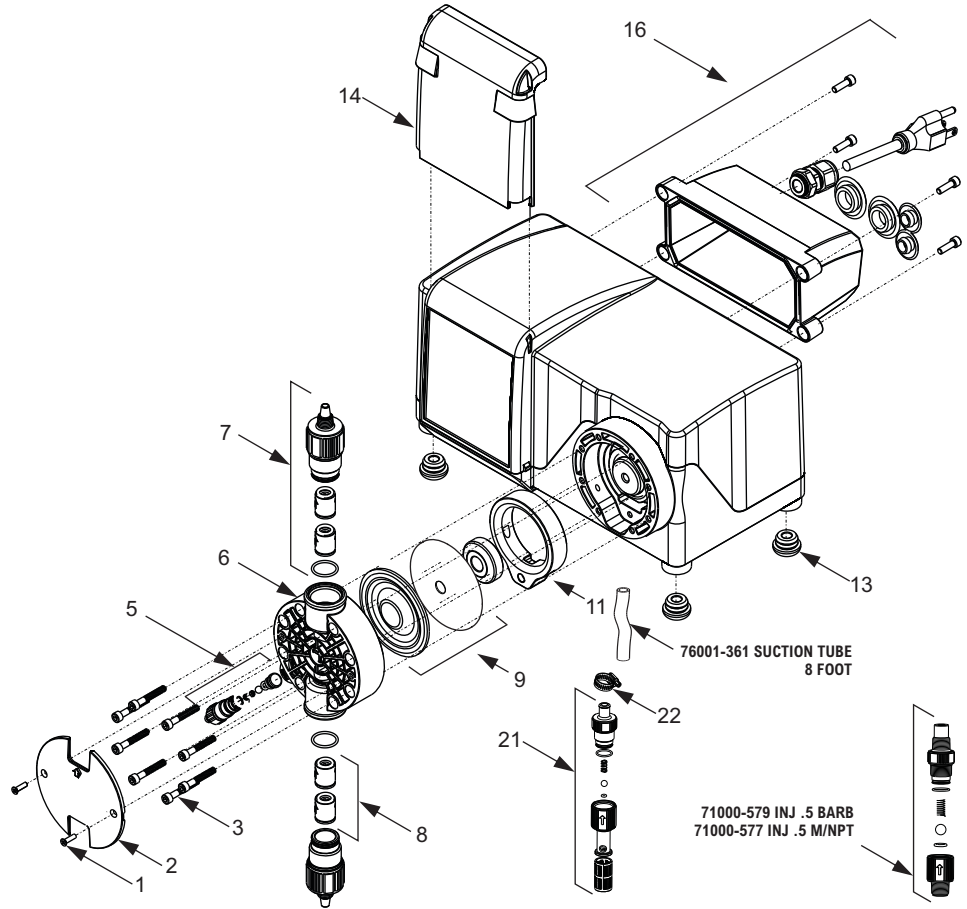

16.2 C3 Parts List

ITEM	PART NO.	DESCRIPTION	QTY REQ.
1	90011-081	SCREW 6-32 X .5	2
2	90001-157	COVER P/H C3	1
	90001-158	COVER P/H C3 NO LOGO	1
3	90011-181	SCREW 10X32 X 1.25	8
4	90011-049	WASHER #10 P/H SS	8
5	70001-353	PRIME VALVE VITON®	1
	70001-354	PRIME VALVE EP	
6	90002-258	P/HEAD LG C3 PVDF	1
7	70001-349	VALVE .5 M/NPT VIT	2
	70001-350	VALVE .5 M/NPT EP	
	70001-351	VALVE .5 F/NPT VIT	
	70001-352	VALVE .5 F/NPT EP	
	70001-347	VALVE .5 T-BARB VIT	
	70001-348	VALVE .5 T-BARB EP	
8	20000-194	KIT 4 EA. VALVE VIT	1
	20000-195	KIT 4 EA. VALVE EP	
9	72000-295	DIAPH. KIT C3 KYNAR	1
13	90003-561	BUMPER FEET	4
14	90002-326	UV LCD CVR PLYCRB	1
16	71010-027	J-BOX KIT W/ 115V	1
	71010-028	J-BOX KIT W/ 230V	1
	71010-029	J-BOX KIT W/ 220V	1
21	71000-575	FOOTVALVE .5 T CR VIT	1
	71000-447	FTVALVE .5 CR VT/AF NO SP	
	71000-325	FOOTVALVE .5 CR EP NO SP	
22	90008-043	CLAMP SS .5"	1
23	76001-361	TUBE SUCTION .5 D, 8' L	1
24	71000-579	INJECTION .5 BARB	1
	71000-577	INJECTION .5 M/NPT	

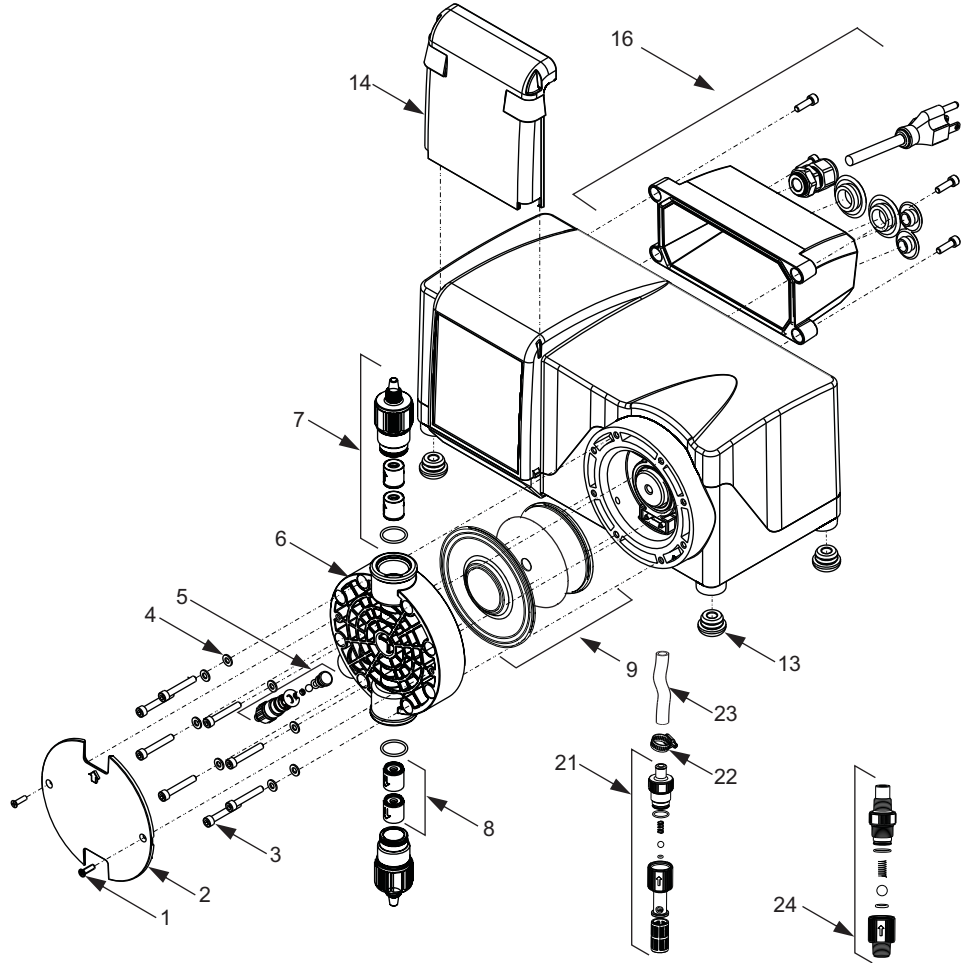

## 17.0 DFD (Diaphragm Failure Detection)

Chem-Pro® is equipped with a Diaphragm Failure Detection System which is designed to stop pump and provide an output alarm in event diaphragm should rupture and chemical enters pump head. Pump will detect a chemical with a conductivity reading greater than 500 microsiemens. Chemicals with a conductivity of less than 500 microsiemens will not be detected.

This system is capable of detecting presence of a large number of chemicals including Sodium Hypochlorite (Chlorine), Hydrochloric (muriatic) Acid, Sodium Hydroxide, and many others. System will not be triggered by water (rain, condensation, etc.) or lubricants.

If system has detected chemical, pump diaphragm must be replaced and pump head must be thoroughly cleaned. Failure to clean pump head will void warranty.

If DFD alarm occurs, pump will stop, close an alarm output, and screen will flash DFD with an alarm icon.

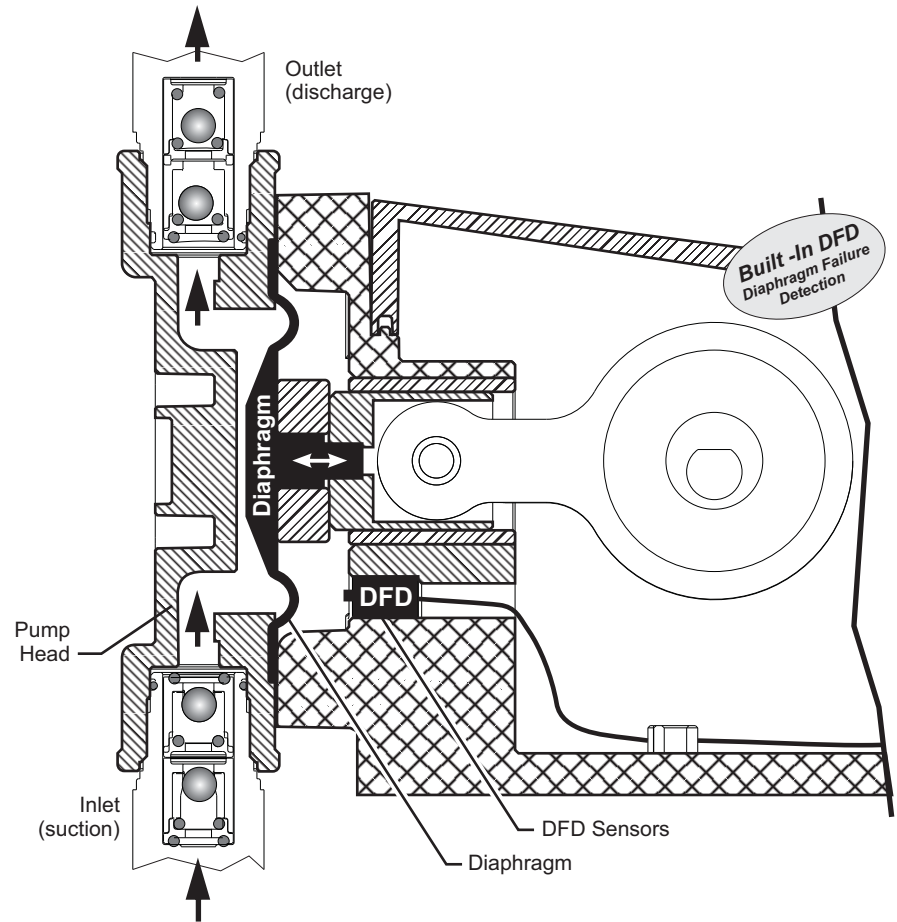

### Typical Installation

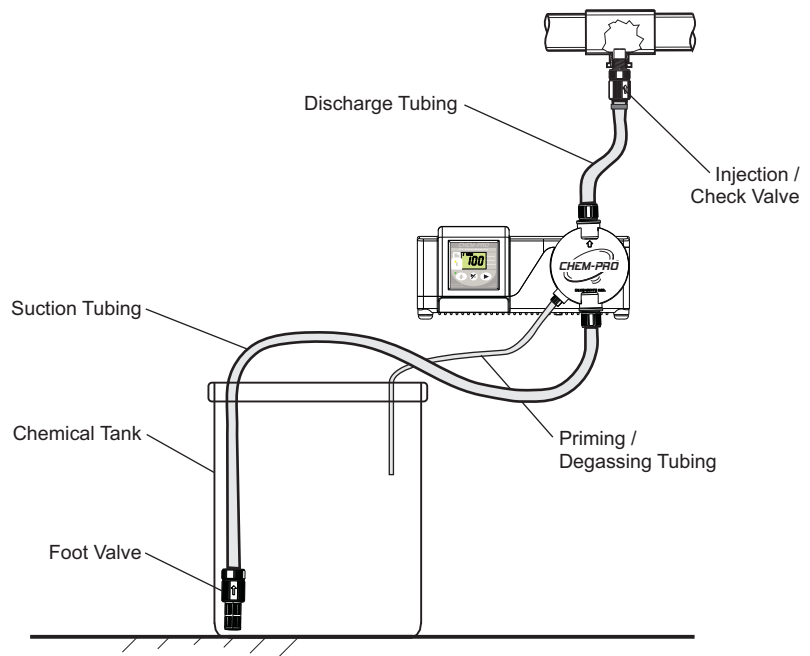

## 18.0 Output Versus Pressure

### 18.1 C2 Output V. Pressure

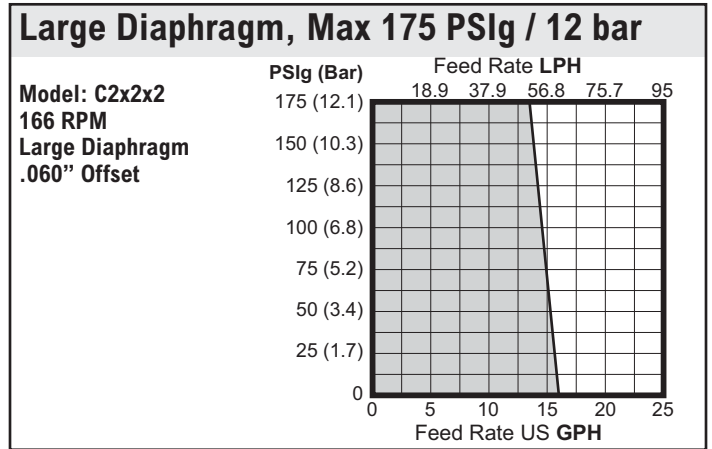
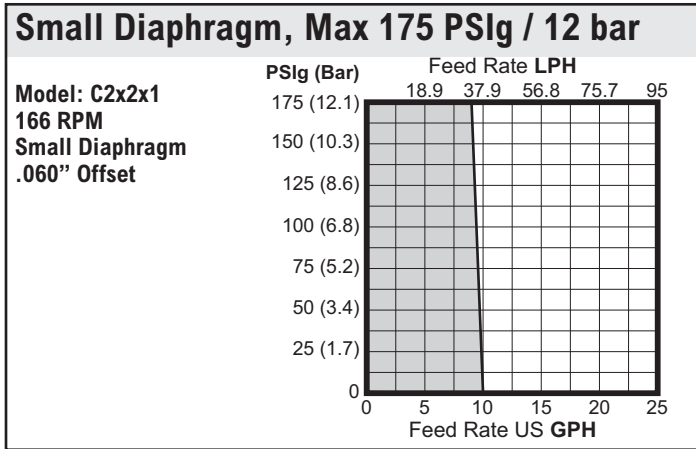
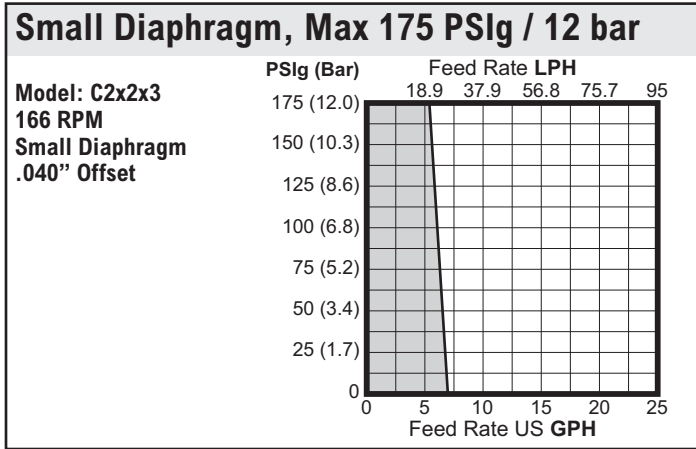

### 17.2 C3 Output V. Pressure

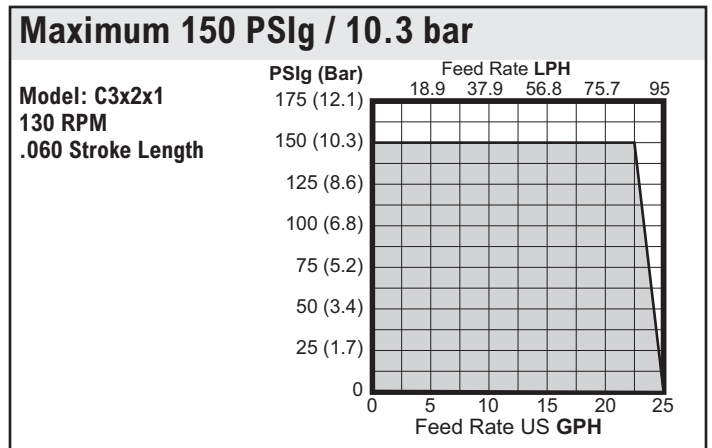
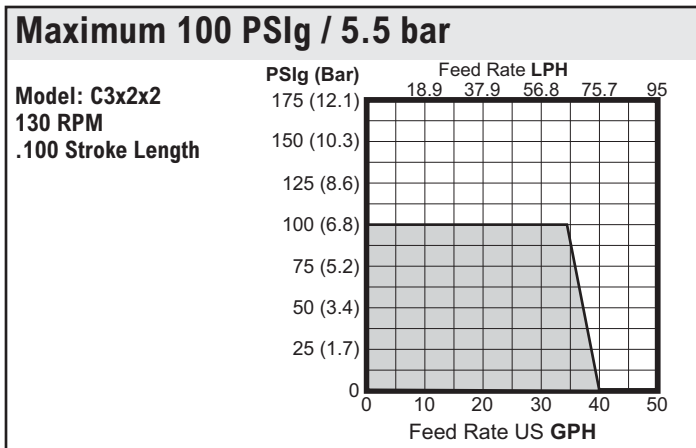

### LIMITED WARRANTY

Your new Clem-Pro pump is a quality product and is warranted for 24 months from date of purchase (proof of purchase is required). The pump will be repaired or replaced at our discretion.

### WHAT IS NOT COVERED

- **Pump diaphragm and rubber components – They are perishable and require periodic replacement.**
- **Pump removal, or re-installation, and any related labor charge.**
- **Freight to the factory, or ProSeries service center.**
- **Pumps that have been tampered with, or in pieces.**
- **Damage to the pump that results from misuse, carelessness such as chemical spills on the enclosure, abuse, lack of maintenance, or alteration which is out of our control.**
- **Pumps damaged by faulty wiring, power surges or acts of nature.**

Blue-White Industries does not assume responsibility for any loss, damage, or expense directly or indirectly related to or arising out of the use of its products. Failure must have occurred due to defect in material or workmanship and not as a result of operation of the product other than in normal operation as defined in the pump manual.

Warranty status is determined by the pump's serial label and the sales invoice or receipt. The serial label must be on the pump and legible. The warranty status of the pump will be verified by Blue-White Industries or a factory authorized service center.

### OTHER IMPORTANT WARRANTY INFORMATION

Please be advised; injection and metering devices are not intended as a means of treating water to render it suitable for human consumption. When used as hypochlorinators, they are meant to destroy bacteria and algae contamination, before its removal by filtration. Acid and soda injectors are used for PH control (balance). Blue-White Industries injectors are factory tested with water only for pressure and performance. Installers and operators of these devices must be well informed and aware of the precautions to be taken when injecting various chemicals -especially those considered hazardous or dangerous, eye protection must be worn when working around this product or any other metering type of pump.

Should it become necessary to return the pump for repair or service, you must attach information regarding the chemical used as some residue may be present within the unit which could be a hazard to service personnel.

Blue-White Industries will not be liable for any damage that may result by the use of chemicals with their injectors and its components. Thank you.

### PROCEDURE FOR IN WARRANTY REPAIR

Contact the factory to obtain a RMA (Return Material Authorization) number. Carefully pack the pump to be repaired. It is recommended to include foot strainer and injection/check valve fitting since these devices may be clogged and part of the problem. Please enclose a brief description of the problem as well as the original invoice or sales receipt, or copy showing the date of purchase. Prepay all shipping costs. COD shipments will not be accepted. Warranty service must be performed by the factory or an authorized ProSeries service center. Damage caused by improper packaging is the responsibility of the sender. When In-Warranty repair or replacement is completed, the factory pays for return shipping to the dealer or customer.



Users of electrical and electronic equipment (EEE) with the WEEE marking per Annex IV of the WEEE Directive must not dispose of end of life EEE as unsorted municipal waste, but use the collection framework available to them for the return, recycle, recovery of WEEE and minimize any potential effects of EEE on the environment and human health due to the presence of hazardous substances. The WEEE marking applies only to countries within the European Union (EU) and Norway. Appliances are labeled in accordance with European Directive 2002/96/EC. Contact your local waste recovery agency for a *Designated Collection Facility* in your area.

**ProSeries®**  
by Blue-White Ind.

5300 Business Drive, Huntington Beach, CA 92649 USA

Phone: 714-893-8529 FAX: 714-894-9492

E mail: [sales@blue-white.com](mailto:sales@blue-white.com) or [techsupport@blue-white.com](mailto:techsupport@blue-white.com) URL: [www.blue-white.com](http://www.blue-white.com)