

CALL TOLL FREE 877-742-2878 FOR SALES AND SUPPORT

ARO[®]

Click Here to return to BurtProcess.com

LUBRICATION EQUIPMENT

PUMPS AND ACCESSORIES



ARO® Lubrication Equipment.

For over 85 years, the ARO® Fluid Products business of Ingersoll Rand® has developed relationships with more than 200 original equipment manufacturers and distributors, enabling us to better focus on the unique pumping needs of many industries. It is a strategic merger of our customers' application expertise, along with our decades-long legacy of designing and building outstanding piston and diaphragm pumps.

ARO® delivers unmatched dependability and productivity with a full range of lubrication products built to a global quality standard to keep all types of fluids moving efficiently.

ARO® offers a versatile range of piston and diaphragm pumps capable of meeting the specific needs of your applications. Available in multiple sizes and configurations with a broad selection of pressure ratios and displacement rates, our pumps can help unlock superior performance and increase production across a number of unique applications.

Lubrication Equipment Warranty

ARO® lubrication equipment is built with the finest materials to deliver reliable products with extended durability. Our warranty is your assurance of a quality product.



Features

- ▶ Piston pumps for grease — or for motor oil, gear oil, and transmission fluid
- ▶ No lubrication or complex controls required
- ▶ Digital / metered fluid control handles are precise and easy to use
- ▶ High-pressure grease control handles
- ▶ Full range of general lubrication fittings and accessories

Content

	Page
Oil and Grease Pumps	4
Piston Pump Accessories	7
Grease Pumps	9
Grease Pump Accessories	12
Diaphragm Pumps	14
Diaphragm Pump Accessories	18
Control Handles	20
Control Handle Accessories	22
Hand-operated Pumps	23
Fittings and Accessories	24
General Installation Accessories	26
Filter/Regulator/Lubricators	31
Warranty Policy	33

Application advantages of ARO® lubrication pumps:



Transfer & Supply: ARO® lubrication pumps are designed to move high volumes of fluids in order to minimize time spent filling or emptying large containers.



Lubrication: ARO® lubrication pumps offer a variety of flow rates and pressures to meet your need in moving oil and grease to lubricate equipment and machinery.

Used for:

- ▶ Material Transfer
- ▶ Vehicle Service
- ▶ Mining and Construction Equipment
- ▶ General Machinery



ARO® Piston Pumps and Packages for Oil and Grease

ARO® lubrication pumps deliver unmatched industrial-strength performance and are sized to fit any container - large (275-gal/400-lb, 1040.9 L / 181.4 kg) to small (5-gal/35-lb, 18.9 L/15.9 kg).

They pump motor and gear oils, transmission fluid, and standard and industrial greases. Pumps are offered from 3:1 to 100:1 ratios in order to meet the requirements of any application - commercial vehicle servicing to lubricating heavy mining equipment.

Saving You Time and Money

Our simple pump designs allow service by any owner or qualified technician.

► Reliable Performance:

- Patented design improves flow, reduces pulsation and extends service life
- Various size motors can produce the right pressure for any application

► Durability:

- ARO® stand behind its pumps with a 5-year warranty
- Stall-free motor is contained in a rugged housing

► Low Maintenance Time and Cost:

- Can service pumps in-line with no special tools required
- Fewer parts than comparable pumps mean easier servicing, reduced service time
- No air line lubrication required



3:1

5:1

Commercial

Motor Oil, Gear Oil, Transmission Fluid

Oil Pumps and Packages

	3:1 Ratio	5:1 Ratio
Lower Pump Material	Carbon Steel	Carbon Steel
Air Motor Diameter	2"	3"
Air Inlet Pressure Range psi (bar)	0-150 (0-10.3)	0-150 (0-10.3)
Fluid Pressure Range psi (bar)	0-450 (0-31)	0 - 750 (0 - 51.7)
Stroke Length	3"	3"
Max.Recommended Cycles/Minute	125	120
Flow Rate gpm (lpm)	3.4 (12.87)	4.3 (16.27)
Cycles Per Gallon (Liter)	37 (9.8)	28 (7.4)
Air Inlet Size	1/4" (F)	1/4" (F)
Fluid Outlet Size	1/2" (F)	1/2" (F)
Fluid Inlet Size	3/4" (F)	1 1/2" (F)
Noise Level @ 100 psi – 124 cpm	80 db(A)	85 db(A)



3:1 Oil
LM2203A-11-C



5:1 Oil
LM2305A-11-B

Model	Container size gal (L)
3:1 PISTON PUMP	
LM2203A-11-C (-12-C = BSP Thread)	Stub
LM2203A-31-C (-32-C = BSP Thread)	16 (60.6)
LM2203A-41-C (-42-C = BSP Thread)	55 (208.2)
LM2203A-51-C (-52-C = BSP Thread)	275 (1040.9)
5:1 PISTON PUMP	
LM2305A-11-B (-12-B = BSP Thread)	Stub
LM2305A-31-B (-32-B = BSP Thread)	16 (60.6)
LM2305A-41-B (-42-B = BSP Threads)	55 (208.2)
LM2305A-51-B (-52-B = BSP Threads)	275 (1040.9)

Piston Pump Packages

Model	Description	Pump model	Meter	Control handle	Dolly	Drum cover	Hose	Valve
3:1 OIL PUMP PACKAGES								
LP2100-1-B	16-gal (60.6 L) portable pump package	LM2203A-31-C	635190-1 (pint)	635391-1	640058-2	94421	623501-6	67085
LP2101-1-B	16-gal (60.6 L) portable pump package	LM2203A-31-C	635190-3 (L)	635391-1	640058-2	94421	623501-6	67085
5:1 OIL PUMP PACKAGES								
LP3100-1-B	16-gal (60.6 L) portable pump package	LM2305A-31-B	635190-1 (pint)	635391-1	640058-2	94421	623501-6	N/A
LP3101-1-B	16-gal (60.6 L) portable pump package	LM2305A-31-B	635190-3 (L)	635391-1	640058-2	94421	623501-6	N/A



LP2100-1-B



LP3100-1-B

Common Accessories

Model	Description
61113	Wall Mount Bracket
66073-1	Air Line Connection
67145-3-B (3:1 Ratio)	2" Bung Adapters
67145-4-B (5:1 Ratio)	2" Bung Adapters
637224	LM2203A Service Kit
637226	LM2305A Service Kit

1:1

9:1

Industrial

Piston Pumps

Industrial Oil Pumps

	1:1 Ratio	9:1 Ratio
Lower Pump Material	Carbon Steel	Carbon Steel
Air Motor Diameter	2"	4 1/4"
Air Inlet Pressure Range psi (bar)	0-150 (0-10.3)	0-150 (0-10.3)
Fluid Pressure Range psi (bar)	0-150 (0-10.3)	0-1350 (0-93.1)
Stroke Length	6"	4"
Max. Recommended Cycles / Minute	75	75
Flow Rate gpm (lpm)	9 (34)	3.9 (14.8)
Cycles Per Gallon (Liter)	12.3 (3.2)	19.2 (5.0)
Air Inlet Size	1/4" (F)	1/2" (F)
Fluid Outlet Size	3/4" (F)	3/4" (F)
Fluid Inlet Size	Immersed	Immersed
Noise Level @ 60 psi – 40 cpm	77.8 db(A)	89.2 db(A)

Heavy-duty Piston Pumps (for oil service)

Model	Packing Material (Upper/Lower)	Container size gal (L)
PISTON PUMP 1:1 RATIO 2" DIAMETER AIR MOTOR (200 SERIES)		
612041-1	Nitrile/Nitrile	55 (208.2)
612041-3	PTFE/PTFE	55 (208.2)
612042-1	Nitrile/Nitrile	275 (1041)
PISTON PUMP 9:1 RATIO 4-1/4" DIAMETER AIR MOTOR (AF0409 SE)		
AF0409A13PFL1	Polyurethane/UHMW-PE	Stub
AF0409A43PFL1	Polyurethane/UHMW-PE	16 (60.6)
AF0409A53PFL1	Polyurethane/UHMW-PE	55 (208.2)

612041-1

1:1 ratio pump ideal for pumping motor oil, gear oil, and transmission fluid. This model fits a standard 55-gal (208.2 L) drum (including bung adaptor).



612042-1

1:1 ratio piston pumps are ideal for moving oils and fluids at high volumes. This model is designed for 275 obround tanks.



AF0409

AF0409 Series pumps are designed with a 9:1 pump ratio, 4-1/4" (108 mm) air motor, and are ideal for pumping heavy oils over long distances.



Common Accessories

Model	Description
67445-1*	Muffler Kit
635040 (1:1)	ARO-Stop Valve
23644-400 (9:1)	ARO-Stop Valve
F35341-400	Air Line Filter
67442*	Ball Valve Regulator
637489*	Universal Air Motor Kit
637081	Service Kit (612041-1, 612042-1)
637083	Service Kit (612041-3)
637486	Service Kit (AF0409A)

* Use with AF0409A

Piston Pump Accessories

Model	Description	For use with
5-GAL CONTAINERS		
65986	Siphon tube has 6' (1.8 m) long, 3/4" (19 mm) ID hose with 3/4" (1.9 cm) NPT (M) outlet; hose is neoprene over Thiokol and includes 91020-1 tube.	Wall-mounted stub pumps
55-GAL CONTAINERS		
65986-1	Siphon tube has 6' (1.8 m) long, 3/4" (19 mm) ID hose with 3/4" (1.9 cm) NPT (M) outlet; hose is neoprene over Thiokol.	Drum cover for closed drum w/ 2" (50.8 mm) bung opening
61601	Speeds 55-gal (208.2 L) drum change-over. No need to handle pump. Includes 622651-06 hose, Y45-24-C adapter bushing, Y43-5-C street elbow, and 65109 (36" long, 914 mm) carbon steel suction tube; 3/4" (19 mm) NPT(F) fluid outlet.	Wall-mounted stub pumps
66779	For pumping from 55-gal (208.2 L) drum. PVC tube has foot valve for positive priming. Includes 76193 bung adapter, adjustable to approximately 35-1/2" (902 mm); 1" (25.4 mm) NPT (F) fluid outlet.	Stub pumps and diaphragm pumps
61409	For pumping from 55-gal (208.2 L) drum. 90° PVC siphon tube, 35-1/2" (902 mm) long with 2" bung adapter for 55-gal drums. Can easily be cut to desired length, on site; 1/2" (12.7 mm) NPT (F) outlet.	1/2" diaphragm pumps and stub pumps
91020-2	1/2" (12.7 mm) galvanized suction tube for 55-gal (208.2 liter) containers; 36" long (914 mm).	
275-GAL CONTAINERS		
66779-2	For pumping from 275-gal (1040.9 L) tanks. PVC diaphragm tube has foot valve for positive priming. Includes 76193 bung adapter, adjustable to approximately 48-1/4" (1232 mm). 1" (25.4 mm) NPT (F) fluid outlet.	Stub pumps and pumps



66779

Piston Pump Accessories

Fittings

Model	Hose size ID in (mm)	Hose length ft (m)	Hose material	Fluid inlet NPT (M) in (mm)	Fluid outlet (NPT) in (mm)	Used with
SIPHON HOSE, CARBON STEEL FITTINGS						
622701-6	1" (25.4)	6' (1.8)	Nylon tube with oil-resistant cover	1" (25.4)	1" (25.4)	Carbon steel siphon tube
STAINLESS STEEL FITTINGS						
622702-6	1" (25.4)	6' (1.8)	Nylon tube with oil-resistant cover	1" (25.4)	1" (25.4)	Stainless steel siphon tube

Inlet Material Filters

Model	Description	For use with
651830	Filter element keeps foreign matter from entering lower pump end	Adapts to 91020-1 or -2 pipe extension.
66480	Filter and check valve assembly constructed of 316 stainless steel, assembly has 1" (25.4 mm) NPT (F) connections and 40-mesh screen; 4-3/4" (121 mm) long x 2-1/8" (54 mm) in diameter	Used with suction tubes when fluid is corrosive and viscosity requires a foot valve for positive priming.



Wall Mount Bracket

Model	Description	For use with
61113	2" (50.8 mm) NPT (F) opening for bung-type pumps; bracket can slip over rim of open-head drum or be wall-mounted	55-gal (208.1 L) bung-type pumps and AFX Series, LM Series and 61204X-X Pumps fitted with bung adapters
66100	Wall-mount bracket has removable mounting plate	AFX Series, 4" (101.6 mm) stroke pumps
66101	Wall-mount bracket has removable mounting plate	AFX Series, 6" (152.4 mm) stroke pumps



Bung Adapters

Model	Description	For use with
60870	2" (50.8 mm) (M) for use with 2-1/8" (57.1 mm) siphon tube	61204X-X, 1:1 ratio immersed pumps
67145-3-B	2" (50.8 mm) (M)	AFX Series, 9:1 ratio immersed pumps
67145-4-B	2" (50.8 mm) (M)	LM Series, 3:1 oil pumps
BUNG ADAPTER SEAL KITS		
67088-3	Water-tight seal kit includes 67145-3 bung adapter and 67088 seal kit	LM Series 3:1 oil pumps
67088-4	Same as above, except includes 67145-4 bung adapter and 67088 seal kit	LM Series 5:1 oil pumps



50:1
2"/3"

Commercial

Grease Pumps and Packages

50:1 Commercial Grease Pumps

	2" Motor LM2250E-XX-B	3" Motor LM2350E-XX-B
Lower Pump Material	Carbon Steel	Carbon Steel
Air Motor Diameter	2"	3"
Air Inlet Pressure Range psi (bar)	0-150 (0-10.3)	0-150 (0-10.3)
Fluid Pressure Range psi (bar)	0-7500 (0-517.2)	0-7350 (0-506.8)
Stroke Length	3"	3"
Max. Recommended Cycles/Minute	80	135
Flow Rate lbs/min (kg/min)	2 (1)	4 (2)
Cycles Per Gallon (Liter)	12.3 (3.2)	19.2 (5.0)
Air Inlet Size	1/4" (F)	1/4" (F)
Fluid Outlet Size	3/8" (F)	3/8" (F)
Fluid Inlet Size	Immersed	Immersed
Noise Level @ 60 psi – 40 cpm	85 db(A)	85 db(A)

Grease Pumps

Model	Container size lb (kg)
50:1 PISTON PUMP	
2" DIAMETER AIR MOTOR (3" STROKE)	
LM2250E-21-B (-22 = BSP thread)	35 (15.8)
LM2250E-31-B (-32 = BSP thread)	120 (54.4)
LM2250E-41-B (-42 = BSP thread)	400 (181.4)
LM2250E-61-B (-61 = BSP thread)	60 (27.2)
3" DIAMETER AIR MOTOR (3" STROKE)	
LM2350E-21-B (-22-B = BSP thread)	35 (132.4)
LM2350E-31-B (-32-B = BSP thread)	120 (454.2)
LM2350E-41-B (-42-B = BSP thread)	400 (1514.2)
LM2350E-61-B 4 (2)	60 (227.1)

Service Kits

	Kit No.
LM2250E	637332
LM2350E	637227-B

Grease Pump Packages

Model	Size	Pump model	Control handle	Dolly	Drum cover	Fluid Hose	Follower plate	Handle	Adapter	Z-Swivel
2" DIAMETER AIR MOTOR										
LP2001-1-B	35-lb (15.8 kg)	LM2250E-21-B	N/A	N/A	94420	N/A	640095-2-B	94334	N/A	N/A
LP2002-1-B	35-lb (15.8 kg)	LM2250E-21-B	636111	N/A	94420	624201-10	640095-2-B	94334	76493	636077
LP2003-1-B	120-lb (54.4 kg)	LM2250E-31-B	N/A	N/A	94421	N/A	640165	N/A	N/A	N/A
LP2004-1-B	120-lb (54.4 kg)	LM2250E-31-B	636111	N/A	94421	624201-10	640165	N/A	76493	636077
LP2006-1-B	120-lb (54.4 kg)	LM2250E-31-B	636111	640058-2	94421	624201-10	640165	N/A	76493	636077
LP2007-1-B	120-lb (54.4 kg)	LM2250E-31-B	636111	640062 (cart)	94421	624201-10	640165	N/A	76493	636077
3" DIAMETER AIR MOTOR										
LP3001-1	35-lb (15.8 kg)	LM2350E-21-B	636103	N/A	94420	624201-10	640095-2-B	94334	76493	636077
LP3002-1	120-lb (54.4 kg)	LM2350E-31-B	N/A	N/A	94421	624401-4	640165	N/A	N/A	N/A
LP3003-1	120-lb (54.4 kg)	LM2350E-31-B	636103	640057	94421	624201-10	640165	N/A	76493	636077
LP3004-1	120-lb (54.4 kg)	LM2350E-31-B	636111	640058-2	94421	624201-10	640165	N/A	76493	636077
LP3005-1	400-lb (181.4 kg)	LM2350E-41-B	N/A	N/A	94422	624401-4	N/A	N/A	N/A	N/A
LP3006-1	120-lb (54.4 kg)	LM2350E-31-B	636103	640062 (cart)	94421	624201-10	640165	N/A	76493	636077
LP3007-1	60-lb (27.2 kg)	LM2350E-61-B	636111	N/A	71740-1	624401-4	N/A	N/A	N/A	636077
LP3008-1	35-lb (15.8 kg)	LM2350E-21-B	N/A	N/A	94420	624201-10	640095-2-B	94334	76493	N/A
LP3009-1	400-lb (181.4 kg)	LM2350E-41-B	N/A	N/A	94422	624401-4	640015-1	N/A	N/A	N/A



50:1
75:1
100:1



Grease Pumps and Packages

4-1/4" and 6" Air Motor Grease Pumps

	50:1 Ratio	75:1 Ratio	100:1 Ratio
Stroke (double acting)	4" (10.2 cm)	4" (10.2 cm)	6" (15.2 cm)
Material Outlet	1/2" NPT(F)	1/2" -14 NPT	1/2" NPT(F)
Air Inlet (female)	1/2" NPT(F)	1/2" -14 NPT	1/2" NPT(F)
Air Inlet Pressure Range psi (bar)	30 - 150 (2 - 10.3)	30 -100 (2 - 6.9)	30 - 100 (2 - 6.9)
Fluid Pressure Range psi (bar)	1500 - 7500 (103 - 517)	0 - 7500 (0 - 517)	3000-10000 (207- 690)
Max Delivery/Minute @ 75 cycles	5.7 lbs (2.59)	5.5 lbs/min (2.5 kg)	5.7 lbs (2.59)
Material Inlet	Immersed	Immersed	Immersed
Noise Level @ 60 psi dBA	81.8	81.8	84.7

Pump Model *	Plunger Material	Upper Packings	Lower Packings	Lower Pump Model	Packaging Service Kit
Container Suitability - 16 GAL / 120 LB Drum					
AF0450L43PKL1	Carbon Steel	Polyurethane	Glass Filled PTFE	-	65130
AF0475L43PBL1	Carbon Steel	Polyurethane	Buna "N"	-	637512
AF060BL43PKL1**	Carbon Steel	Polyurethane	Glass Filled PTFE	-	65130
Container Suitability - 55 GAL / 400 LB Drum					
AF0450L53PKL1	Carbon Steel	Polyurethane	Glass Filled PTFE	-	65130
AF0475L53PBL1	Carbon Steel	Polyurethane	Buna "N"	-	637512
AF060BL53PKL1**	Carbon Steel	Polyurethane	Glass Filled PTFE	-	65130

* Add "-1" to Model No. for Ball Valve Regulator

** WARNING: These 100:1 pumps deliver pressures up to 10,000 psi and can only be used in permanently installed systems where the pump is connected directly to piping with the proper rating for the application.



AF0475

Grease Pump Packages

Model No.	Package Type	Pump Model	Drum Cover	Bung Adapter	Material Hose	Air Hose	Ball Valve Regulator	Follower
DC0450L53PKL1000	55 Gallon Drum Cover	AF0450L53PKL1	60898	4148	624401-8	621501-5	-	-
DM0450L53PKL1000	55 Gallon Drum Mount	AF0450L53PKL1	-	4148	624401-8	621501-5	-	-
DC0475L53PBL1C11	55 Gallon Drum Cover	AF0475L53PBL1	71060-1	4148	-	-	67442	640015-2
DM0475L53PBL1C11	55 Gallon Drum Mount	AF0475L53PBL1	-	4148	-	-	67442	640015-2
DC060BL43PKL1C11*	16 Gallon Drum Cover	AF060BL43PKL1-1	66715	-	-	-	-	640152-1
DC060BL53PKL1C11*	55 Gallon Drum Cover	AF060BL53PKL1-1	71060-1	60870	-	-	-	640015-5



DCX Series
Drum Cover



DMX Series
Drum Mount

High-pressure Wash and Tire-Fill Pump Package

High-power cleaning solutions

Perfect for cleaning:

- Cars and trucks
- Engines
- Construction equipment
- Aircraft
- Farm equipment
- Plant structures
- Railroad equipment
- Fleet vehicles

With the application of:

- Degreasers
- Detergents
- Cleaning solutions
- Water
- Metal brighteners
- Aluminum brighteners



WP0409C81BBW2000

Wash Pumps

	9:1 Ratio
Lower Pump Material	Stainless Steel
Air Motor Diameter	4 1/4"
Air Inlet Pressure Range psi (bar)	0-150 (0-10.3)
Fluid Pressure Range psi (bar)	0-1500 (0-103)
Stroke Length	4"
Max. Recommended Cycles /	60
Flow Rate gpm (lpm)	2.9 (10.8)
Cycles Per Gallon (Liter)	21 (5.5)
Air Inlet Size	1/2" (F)
Fluid Outlet Size	3/4" (F)
Fluid Inlet Size	Barbed
Noise Level @ 60 psi – 40 cpm	89.2 db(A)

Model	Packings type / material	
	upper	lower
BASIC PUMPS		
STUB 4-1/4" DIAMETER AIR MOTOR / 4" STROKE		
AF0409C81BBW2	Buna N	Buna N

Model	Description
SPRAY WASH PUMP PACKAGE - 55 GALLON CONTAINER	
WP0409C81BBW2000	4-1/4" (107.9 mm) High-pressure wall-mounted spray package includes AF0409C81BBW2 pump, 61113 wall bracket, 61139-1 55-gal suction tube assembly, 622427-40 material hose (40' / 12.2 m), 641523 control handle, 61133 spray wand, TP6250-18 spray tip and L26241-010 Air Line lubricator

Dollies, Hand Trucks

Model	Description
DOLLIES	
16-GAL DRUM	
640057	Platform-type dolly has four swivel casters and three drum clamps; for use with steel or fiber drums
640058-2	Band-type dolly has four rubber-wheeled casters and screw clamp; for use with steel or fiber drums
HAND TRUCKS	
16-GAL DRUM	
640062	Two-wheel truck has clamp rod and two base supports to hold drum; wheels are rubber
640149	Three-wheel truck includes hinged handle, swivel-type front wheel, and two 6" (152 mm) rubber rear wheels



640057



640058-2



640062



640149

Accessories

Drum Covers

Model	Description	For use with
5 GAL / 35-LB PAIL		
94420	Has 2" (50.8 mm) NPT (F) bung opening and three hold-down screws (fits 10.23" – 12", 259.8 mm –	LM Series 5-gal (18.9 L) bung pumps 304.8 mm OD drums)
16 GAL / 120-LB DRUM		
66492	Has pump opening, mounting holes, and tie-down brackets; order tie-down rods separately (fits 12.75" – 15", 323.8 mm – 381 mm OD Drums)	Models 662402 and 662409
94421	Has 2" (50.8 mm) NPT (F) bung opening and three hold-down screws (fits 13-1/8" – 14-7/8", 333.3 mm – 377.8 mm OD drums)	LM Series 16-gal / 120 lb (60.6 L / 54.4 kg) bung pumps
55 GAL / 400-LB DRUM		
71060-1	Has 2" (50.8 mm) NPT (F) bung opening and tie-down brackets; order tie-down rods separately (fits 20" – 24-5/8", 508 mm – 625.5 mm OD drums)	AFX Series and 61204X-X Pumps, 55-gal / 400-lb (208.1 L / 181.4 kg) bung-type
94422	Has 2" (50.8 mm) NPT (F) bung opening and three hold-down screws; bung pumps (fits 21-7/8" – 23-5/8", 555.6 mm – 600.1 mm OD drums)	55-gal (208.1 L) drum cover models LM2250E-41-B and LM2350E-41-B



94420



94421



71060-1



94422

Follower Plates

MODEL	Wiper seal MATERIAL	OD of pump tube to be fitted IN (MM)	FOR USE WITH
35-LB TAPERED PAIL (FITS 10" – 11" ID DRUMS)			
640095-1-B	Rubber	1" (25)	LM Series 60:1
640095-2-B	Rubber	1-1/2" (38)	LM2250E-21-B, LM2350E-21-B
120-LB DRUM (FITS 13" – 14" ID DRUMS)			
640027	Buna-N	2" (51)	Hand pumps
640152	Buna-N	1-7/8" (48)	AFX Series, 50:1
640152-1	Buna-N	2-1/8" (54)	AFX Series, 100:1
640165	Buna-N	1-1/2" (38)	LM2250E-31-B, LM2350E-31-B
400-LB DRUM (FITS 20" – 23" ID DRUMS)			
640015-2	Buna-N	1-7/8" (48)	AFX Series, 50:1
640015-5	Buna-N	2-1/8" (54)	AFX Series, 100:1
640015-1	Buna-N	1-1/2" (38)	LM2250E-41-B, LM2350E-41-B



640095-2-B

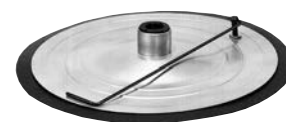

640015-1

Accessories

Bung Adapters

Model	Description	For use with
BUNG ADAPTERS		
4148	2" (50.8 mm) (M) for use with 1-7/8" (47.6 mm) siphon tube	AFX Series, 50:1 ratio grease pumps
67145-2	2" (50.8 mm) (M)	LM, 50:1 grease pumps
BUNG ADAPTER SEAL KITS		
67088	Water-tight seal for use outdoors	LM Series



67145-X

Cover Tie-down Rods

Model	Description	For use with
16-GAL / 120-LB DRUM		
640164	Tie-down bracket kit fixes / holds down drum cover. Includes brackets, rods, mounting hardware. Use with 94421 Cover.	LM Series pumps.
640091	Set of two tie-down rods and mounting brackets. Use with 66492 Cover.	AFX Series and 61204X-X Pumps, 16-gal / 120-lb (60.6 L / 54.4 kg) drum covers
55-GAL / 400-LB DRUM		
71027-1	Set of two tie-down rods and mounting brackets. Use with 71060 cover.	LM Series, also AFX Series and 61204X-X Pumps 55-gal / 400-lb (208.1 L / 181.4 kg) drum covers



640164

640091

Pump Lifts

Model	Description	For use with
SINGLE-POST LIFT		
640067	Single-acting cylinder for easy 55-gal / 400-lb (208.1 L / 181.4 kg) drum change-over. Requires 71060-1 drum cover. Extended height 92" (2.3 mm).	AFX Series, LM Series



640067

3/8"-2"

**PRO
Series**

Diaphragm Pumps

3/8" – 2" (9.5 MM – 50.8 MM) FLUID PORTS

Why ARO® diaphragm pumps?

Our diaphragm pumps are ideal for pumping oil or other light fluids such as antifreeze, water, windshield fluid, fuel (See UL 79 Approved Units), solvents, transmission fluid, and waste oil. Fluid ports for Ingersoll Rand / ARO® diaphragm pumps range in size from 3/8" to 2" (9.5 to 51 mm) to meet the requirements of any application.

- ✔ Safety — Bolted fasteners prevent fluid leaks harmful to workers and the environment
- ✔ Reliability — Unbalanced valve design eliminates valve centering and pump stall-outs, even under low air inlet pressure
- ✔ Flexibility — Variety of body materials allow you to pump different fluids
- ✔ Commitment — Ingersoll Rand / ARO® diaphragm pumps come with a five-year warranty

1 Bolted construction for safe reliability and ease of assembly

All Ingersoll Rand / ARO® diaphragm pumps use bolted construction that process professionals demand. Ingersoll Rand / ARO® non-metallic diaphragm pumps also utilize fasteners that are constructed of 300 Series stainless steel for maximum chemical resistance.

- ✔ Bolted is safer — Bolted construction reduces the risk of spills and environmental contamination, and the attendant, mandatory reports to regulatory agencies that spills can create.
- ✔ Bolted is reliable — Bolted construction withstands the heavy loading that diaphragm pumps are subjected to, without concerns about breakage or loosening.
- ✔ Bolted is easier to assemble — Our bolted design allows for easy positioning and alignment of parts during reassembly. This is a significant advantage over band-clamp style pump fasteners, which are difficult to align and hold together during reassembly.
- ✔ Bolted is less expensive — This design uses standard bolts that cost significantly less to replace. Non-standard fastening devices (such as band clamps) are considered wear parts and are more expensive to replace.

2 Positive priming provides instant start-ups

Check valves are located close to the diaphragm chambers, ensuring a positive prime.

3 Ideal for abrasion and solids-handling

Because Ingersoll Rand / ARO® diaphragm pumps do not use the rotating, sliding seals found in rotary and centrifugal pumps, they're used by more process engineers to handle tough abrasion applications.

4 Broad material selection

Ingersoll Rand / ARO® offers a wide selection of materials, allowing your choice of the best possible wetted and non-wetted materials suited to your application.

5 Ingersoll Rand / ARO® patented unbalanced air valve

Our unbalanced air valve design makes all Ingersoll Rand / ARO® diaphragm pumps unstickable. Because the unbalanced valve cannot settle in a neutral position when the pump is shut down, it can't become stuck, requiring the operator to hammer on the pump in order to start up again.

- ✔ Eliminates stalling
- ✔ Uses significantly less power than competition
- ✔ Does not require lubrication
- ✔ Forgiving in dirty air

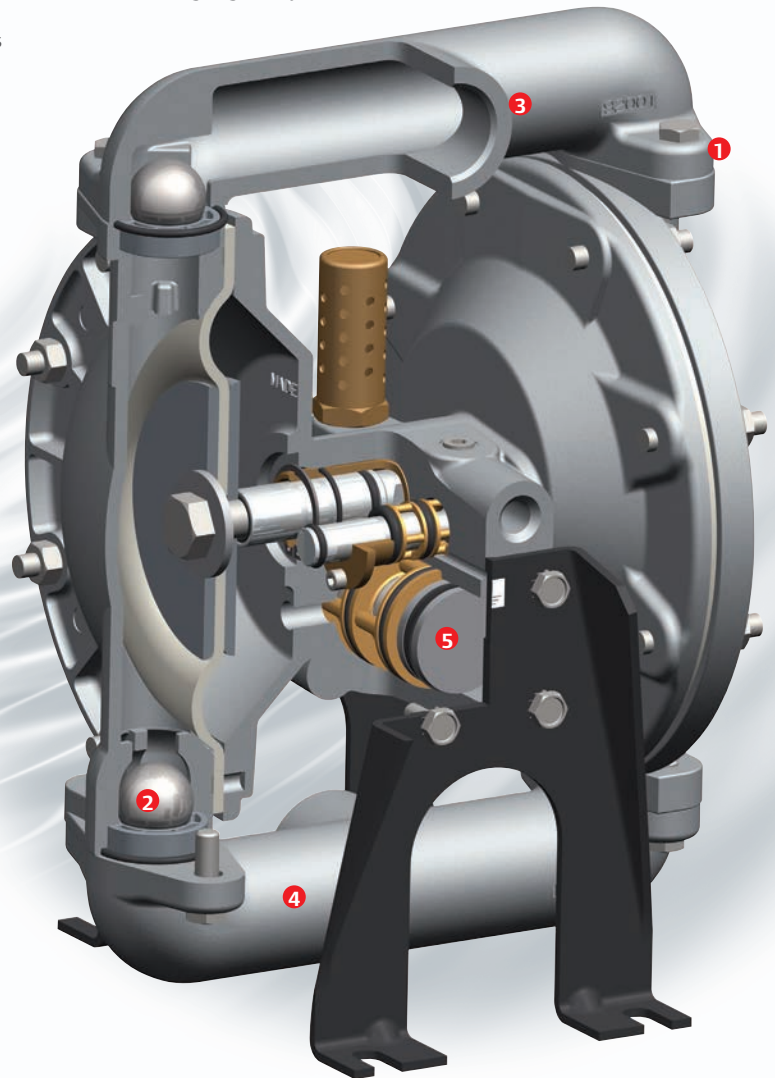

Pro-Series Diaphragm Pumps

Model	Body materials (wetted)	Diaphragm / ball material	Air inlet NPT (F) in (mm)	Fluid inlet / outlet material in (mm)	Max flow gpm l/m	Compatible fluids	Replaces model
3/8" PORTS							
PD03P-ARS-PTT	Polypropylene	PTFE	1/4" (6.3)	3/8" (9.5)	10.6 (40.1)	Windshield fluid, motor / gear oil, transmission fluid, antifreeze	New
PD03P-ARS-PCC	Polypropylene	Hytrel	1/4" (6.3)	3/8" (9.5)	10.6 (40.1)	Windshield fluid, motor / gear oil, transmission fluid, antifreeze	New
PD03P-AES-DTT	Acetal (groundable)	PTFE	1/4" (6.3)	3/8" (9.5)	10.6 (40.1)	Solvents	New
PD03P-AES-DCC	Acetal (groundable)	Hytrel	1/4" (6.3)	3/8" (9.5)	10.6 (40.1)	Windshield fluid, motor / gear oil, transmission fluid, antifreeze	New
1/2" PORTS							
PD05P-ARS-PTT-B	Polypropylene	PTFE	1/4" (6.3)	1/2" (12.7)	14.4 (54.5)	Windshield fluid, motor / gear oil, transmission fluid, antifreeze	66605J-344
PD05P-ARS-PCC-B	Polypropylene	Hytrel	1/4" (6.3)	1/2" (12.7)	14.4 (54.5)	Windshield fluid, motor / gear oil, transmission fluid, antifreeze	66605J-322
PD05P-ARS-PAA-B	Polypropylene	Santoprene	1/4" (6.3)	1/2" (12.7)	14.4 (54.5)	Windshield fluid, antifreeze	66605J-388
PD05P-AES-DTT-B	Acetal	PTFE	1/4" (6.3)	1/2" (12.7)	14.4 (54.5)	Solvents	666056-6A4
PD05P-AES-DCC-B	Acetal	Hytrel	1/4" (6.3)	1/2" (12.7)	14.4 (54.5)	Windshield fluid, motor / gear oil, transmission fluid, antifreeze	66605H-622
1" PORTS							
666100-344-C	Aluminum	PTFE	1/4" (6.3)	1" (25.4)	35 (132.5)	Windshield fluid, motor / gear oil, transmission fluid, antifreeze, solvents	
666100-3C9-C	Aluminum	Hytrel	1/4" (6.3)	1" (25.4)	35 (132.5)	Windshield fluid, motor / gear oil, transmission fluid, antifreeze	
666100-322-C	Aluminum	Buna	1/4" (6.3)	1" (25.4)	35 (132.5)	Windshield fluid, motor / gear oil, transmission fluid, antifreeze	
1-1/2" PORTS							
666150-362-C	Aluminum	Nitrile / Acetal	1/2" (12.7)	1-1/2" (38.1)	90 (340.7)	Windshield fluid, motor / gear oil, transmission fluid, antifreeze	
2" PORTS							
666250-9C9-C	Aluminum	Hytrel	3/4" (19.1)	2" (50.8)	172 (651.1)	Windshield fluid, motor / gear oil, transmission fluid, antifreeze	

Pro-Series Specialty Application Diaphragm Pumps

Model	Body materials (wetted)	Diaphragm / ball material	Air inlet NPT (F) in (mm)	Fluid inlet / outlet material in (mm)	Max flow gpm (L/min)	Compatible fluids
1/2" PORTS						
670042	Aluminum	Viton / Acetal	1/4" (6.3 mm)	1/4" (6) / 1/2" (13)	12 (45.4)	Fuel (UL 79 approved)
1" PORTS						
650717-C	Aluminum	Viton / Acetal	1/4" (6.3 mm)	1" / 1" (25.4 mm)	29 (109.8)	Fuel (UL 79 approved)
1-1/2" PORTS						
650718-C	Aluminum	Viton / Acetal	1/2" (127 mm)	1-1/2" (38.1 mm)	75 (283.9)	Fuel (UL 79 approved)
2" PORTS						
650719-C	Aluminum	Viton / Acetal	3/4" (19.1 mm)	2" (50.8 mm)	105 (397.5)	Fuel (UL 79 approved)

Model	Application	Manifold material	Diaphragm, O-ring material	Air inlet NPT / F in (mm)	Fluid outlet NPT / F in (mm)	Max gpm (L/min)	Package includes
1/2" PORTS							
612999-5	Waste oil evacuation	Polypropylene	Nitrile	1/4" (6)	1/2" (13)	11 (42)	Wall mount, inlet and outlet fluid hoses
612999-6	Waste oil evacuation	Polypropylene	Nitrile	1/4" (6)	1/2" (13)	11 (42)	Hanging bracket and suction hose
1" PORTS							
650715-C	50 / 50 mix of antifreeze and water	Aluminum	Nitrile	1/4" (6)	1" (25.4)	35 (133)	Pump only
612999-3	50 / 50 mix of antifreeze and water	Aluminum	Nitrile	1/4" (6)	1" (25.4)	35 (133)	Wall mount, siphon tubes, material hoses
612999-4	Waste oil evacuation	Aluminum	Nitrile	1/4" (6)	1" (25.4)	35 (133)	Wall mount, inlet and outlet fluid hoses
613201-2-C	Calcium chloride tire filling	Aluminum	Neoprene	1/4" (6)	1" (25.4)	35 (133)	Inlet and outlet hoses, strainer, 8' suction hose, control handle, check valve



650715-C Fuel AntiFreeze/Water Blending Pump (1", 25.4 mm NPTF Outlet)

This 1:1 ratio pump has dual inlets to allow simultaneous pumping and blending of antifreeze and water.



613201-2-C Calcium Chloride Tire-fill Pump Package

Designed for the purpose of evacuating and filling tires with calcium chloride ballast solution. Package includes a 666100-441-C, 1" (25.4 mm) port diaphragm pump. Aluminum construction with neoprene diaphragms and PTFE checks for compatibility with corrosive calcium chloride and 60154 hose / strainer / gun assembly. Also includes check valve and all required clamps and related hardware.



650717-C U.L. approved Fuel Pump

Designed specifically for high-volume transfer, bulk-unloading, or fueling applications. These pumps meet UL 79 specification code and are compatible with gasoline, aviation fuel, diesel fuel, fuel oil and kerosene.

Diaphragm Pumps

Pro-Series Drum Diaphragm Pumps

Drum Pumps

- ARO® Drum Pumps are available in three body materials for optimum fluid compatibility: choose from aluminum, stainless steel or polypropylene body construction.

Drum Pump Packages

- Package Components Factory-Matched – ARO® Drum Pump package components contain pre-specified, matching materials of construction for complete fluid compatibility

Drum Pump Packages can be ordered in 3 styles:

- Basic: Pump, bung adapter, air safety shut-off, siphon tube, weather seal, and base
- Complete / Transfer: basic pump plus fluid hose or fluid hose with non-drip nozzle
- Complete / Dispensing: basic pump plus foot valve, hose and dispensing nozzle



Pump Features

- 11-gpm (13.4 l/m) flow capability: drum pumps offer plenty of capacity to satisfy a broad range of transfer application volume demands
- Stall-free operation: ARO® diaphragm drum pumps feature a patented unbalanced air valve design that avoids stall-out, even under low air-inlet pressures
- Bolted construction: ARO® diaphragm drum pumps utilize bolted fasteners for leak-tight integrity
- 5-year warranty

Ratio	Max flow gpm (L/min)	Displacement per cycle gal (L)	Air inlet NPT / F in (mm)	Fluid inlet NPT	Fluid outlet NPT / F	Max operating pressure psi (bar)	Suspended solids max diameter in (mm)	Shipping weight lb (kg)
1:1 RATIO DRUM PUMP PERFORMANCE SPECIFICATIONS								
1:1	11 (41.6)	.039 (.15)	1/4 (18)	Siphon tube for 55-gal Drum	1/2" - 14	100 (6.8)	3/32" (2.4)	22 (10) Polypropylene, basic package 26 (11.8) Aluminum, basic package 36 (16.3) Stainless, basic package

Model	Pump housing and seats	Pump dia. and balls	Lock out valve (P/N 104253-2)	Foot valve	10' (3.0 m) hose ASM	Dispense valve	Fluid service
DAB05-PPTT-2-A	Polypropylene	PTFE	X	-	-	-	Some Acids & Caustics*
DAB05-PPCC-2-A	Polypropylene	Hytrel	X	-	-	-	Oil
DAB05-PPUU-2-A	Polypropylene	Polyurethane	X	-	-	-	Oil
DAB05-PPAA-2-A	Polypropylene	Santoprene	X	-	-	-	Some Mild Acids / Mild Caustics*
DAB05-PPCC-2-N	Polypropylene	Hytrel	X	-	Nitrile	-	Oil
DAB05-PPCC-B-M	Polypropylene	Hytrel	X	X	Nitrile	No-drip	Oil
DAB05-PPAA-2-B	Polypropylene	Santoprene	X	-	EPDM	-	Some Mild Acids / Mild Caustics*
DAB05-PPUU-2-C	Polypropylene	Polyurethane	X	-	Vinyl	-	Oil
DAB05-PPCC-B-J	Polypropylene	Hytrel	X	X	Reinforced Nitrile	X	Oil
DAB05-PPAA-B-K	Polypropylene	Santoprene	X	X	EPDM	X	Some Mild Acids / Mild Caustics*
DAB05-SSTT-2-A	Stainless Steel	PTFE	X	-	-	-	Solvent
DAB05-ASTT-2-A	Alum / SS	PTFE	X	-	-	-	Solvent
DAB05-APCC-2-A	Alum / Poly	Hytrel	X	-	-	-	Oil / Service Fluids
DAB05-APCC-2-0	Alum / Poly	Hytrel	X	-	Nitrile	-	Oil / Service Fluids
DAB05-APCC-B-P	Alum / Poly	Hytrel	X	X	Nitrile	No-drip	Oil / Service Fluids
DAB05-APCC-B-D	Alum / Poly	Hytrel	X	X	-	X	Oil / Service Fluids
DAB05-APCC-B-L	Alum / Poly	Hytrel	X	X	Reinforced Nitrile	X	Oil / Service Fluids
DAB05-ASAA-2-A	Alum / SS	Santoprene	X	-	-	-	Water / Antifreeze

*Check compatibility for suitability in service with material(s) being pumped



Diaphragm Pump Accessories

Hose

1/2" (12.7 mm) ID hose comes in 10' (3.0 m) lengths.

Model	Material	For use with	Fittings end / end	Dispensing nozzle used with (order separately)
621517-10	Nitrile	Polypropylene	Cam / bare	N/A
621516-10	Nitrile	Polypropylene	Cam / brass 1/4"-18 (6.3 mm) NPT male	635129
621523-10	Nitrile	Polypropylene	Cam / non-drip nozzle	N/A
621515-10	EPDM	Polypropylene	Cam / bare	N/A
621519-10	Vinyl	Polypropylene	Cam / bare	N/A
621514-10	EPDM	Polypropylene	Cam / 1" (25.4) NPT	95199
622514-10	Nylon	Polypropylene	1/2" (12.7 mm) NPT / 1/2" (12.7 mm) NPT 316 stainless steel	
621518-10	Nitrile	Aluminum	Cam / bare	N/A
621520-10	Nitrile	Aluminum	Cam / brass 1/4"-18 (6.3 mm) NPTF	635129
621524-10	Nitrile	Aluminum	Cam / non-drip nozzle	N/A

Note: Hose requires 95189 to adapt to 1/2" port.



621514-10, 95200, 95199
Hose, swivel, and dispensing nozzle



621516-10

Hose and dispensing bibb

Fluid Dispensing Nozzles

Model	Description
95199	Composite Nozzle High-flow nozzle works like gasoline nozzle; features tough composite (polypropylene) construction for caustic service
95200	Swivel 1" (25.4 mm) (M) X 1" (25.4) NPT (F) Polypropylene hose swivel attaches between hose and dispensing nozzle and allows operator to rotate freely; use with 95199
77617	Oil Tapper Fitting Plated carbon steel 1/2"-14 (12.7 mm) NPTF x 3/8"-18 (9.5 mm) NPTF -1; used to attach 95183 oil tapper to 1/2" aluminum pump
635129	Bibb with Trigger 1/4" (6.3 mm) NPT(F) inlet, zinc die casting with brass, and nitrile seals for water or oil service; radiator-type bibb has 1/4" (6.3 mm) fluid inlet and non-drip tip



621523-10
Hose and non-drip nozzle

Foot Valves

Recommended for use with dispensing nozzle. Assembly includes housing, ball check, and O-ring.

Model	Description
637336	Polypropylene with Viton O-ring and ball. Use with 67231
637337	Stainless steel with Viton O-ring and ball. Use with 67231-6 or 67231-7



637336
Foot valve

Drum Bung Adapter Kits

Kit contains base, bung adapter, bung seal, siphon tube, weather seal, and hardware for 55-gallon (208.1 L) drums.

Model	Base material	Tube material	Weather seal	Base seal
67231	Polypropylene	Polypropylene	UHMW PE	Viton
67231-6	Aluminum	Stainless Steel	Viton	Viton
67231-7	Stainless Steel	Stainless Steel	Viton	Viton

Note: Fasteners are 300 Series Stainless Steel



Drum adapter kit

Bulk Tank Adapter Kits

Kit contains base, threaded adapter, and hardware.

Model	Description
67234	Polypropylene / Viton O-ring seal
67234-7	300 series stainless steel



67234
Tank Adapter

Pump Outlet Adapter

Model	Description
95189	Composite Fitting - 1/2" (12.7 mm) NPT (in) x MaleCam adapter (polypropylene)
95190	Aluminum Fitting - 1/2" (12.7 mm) NPT (in) x MaleCam adapter (aluminum)

Suction Tubes

Model	Description	Pumps used with
SUCTION TUBES		
91020-1	1/2" (12.7 mm) galvanized suction tube for 5-gal containers; 16" (406.4 mm) long	1/2" (12.7 mm) diaphragm pumps
65986-1	Siphon tube has 6' (1.8 m) long, 3/4" (19.1 mm) ID hose with 3/4" (19.1 mm) NPT (M) outlet; hose is Neoprene over Thiokol	Drum cover for closed drum with 2" (50.8 mm) bung opening
66779	For pumping from 55-gal (208.1 L) drum; PVC tube has foot valve for positive priming; includes 76193 bung adapter, adjustable to approximately 35-1/2" (901.7 mm); 1" (25.4 mm) NPT (F) fluid outlet	Stub pumps and diaphragm pumps
61409	For pumping from 55-gal (208.1 L) drum; 90° PVC siphon tube, 35-1/2" (901.7 mm) long with 2" (50.8 mm) bung adapter for 55 gal (208.1 L) drums that can easily be cut to desired length on site; 1/2" (12.7 mm) NPT (F) outlet	1/2" (12.7 mm) diaphragm pumps and stub pumps
61412	For pumping from 55-gal (208 L) drum; Threads directly into pump inlet, includes 2" (50.8 mm) bung adapter 36-1/4" (.92 m) long; schedule 80 PVC pipe can easily be cut to desired length on site; 1/2" (12.7 mm) NPT (M) fluid outlet	1/2" (12.7 mm) diaphragm pump

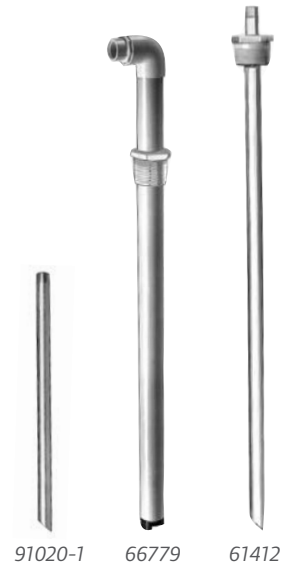

91020-1

66779

61412

Wall-mount Bracket

Model	Description	Pumps used with
DIAPHRAGM PUMPS		
76763	Wall-mount bracket allows pump to be located convenient to container	1/2" (12.7 mm) diaphragm pumps
66100	Wall-mount bracket has removable mounting plate	1" (25.4 mm) diaphragm pumps
62133	Wall-mount bracket	1-1/2" (38.1 mm) diaphragm pumps

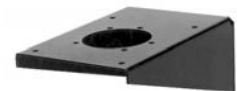

76763

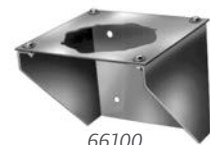

66100



Accessories

NON-METERED AND METERED

Non-metered Fluid Control Handles

Model	Description	Max working pressure psi (bar)	Fluid inlet NPT (F) in (mm)	Fluid outlet
MOTOR OIL, GEAR OIL, TRANSMISSION FLUID				
HIGH-VOLUME				
635193	Has flexible rubber hose with non-drip nozzle; use with 1:1 and 3:1 pumps; Non-drip tip	600 (41)	3/4" (19.1)	629212
635395-2	Has flexible rubber hose with non-drip nozzle; use with 5:1 and 9:1 pumps; non-drip tip	900 (63)	3/4" (19.1)	629212
STANDARD-VOLUME				
635392	Has flexible rubber hose, built-in swivel and filter, and non-drip nozzle; non-drip tip	1,000 (69)	1/2" (12.7)	60164
635399	Has flexible rubber hose, built-in swivel, and right-angle non-drip nozzle; non-drip tip	1,000 (69)	1/2" (12.7)	70790
WATER, ANTIFREEZE				
635129	Radiator bibb	300 (21)	1/4" (6.3)	Non-drip tip



635193



635399



635392

Digital, Metered Fluid Control Handles

Our metered control handle features a patented oval gear wheel design for precise and reliable measurement. Its digital LCD readout operates on two standard alkaline batteries.

- Lightweight
- Precise
- Fast reset
- Totalizes

Model	Max flow rate gpm (L)	Meter / totalizing increments	Max working pressure psi (bar)	Fluid inlet NPT (F) in (mm)	Fluid outlet
METERED, RIGID NOZZLE MODELS					
635390-11	4 (15)	Pints / gallons	1,000 (69)	1/2" (12.7)	Non-drip tip
635390-22	4 (15)	Quarts / gallons	1,000 (69)	1/2" (12.7)	Non-drip tip
635390-33	4 (15)	Liters / liters	1,000 (69)	1/2" (12.7)	Non-drip tip
NON-METERED, RIGID NOZZLE MODELS (HANDLE AND NOZZLE ONLY)					
635391-11	4 (15)	-	1,000 (69)	1/2" (12.7)	Non-drip tip
METERED, FLEXIBLE NOZZLE MODELS					
635390-1	4 (15)	Pints / gallons	1,000 (69)	1/2" (12.7)	Non-drip tip
635390-2	4 (15)	Quarts / gallons	1,000 (69)	1/2" (12.7)	Non-drip tip
635390-3	4 (15)	Liters / liters	1,000 (69)	1/2" (12.7)	Non-drip tip
NON-METERED, FLEXIBLE NOZZLE MODELS (HANDLE AND NOZZLE ONLY)					
635391-1	4 (15)	-	1,000 (69)	1/2" (12.7)	Non-drip tip



635390-X

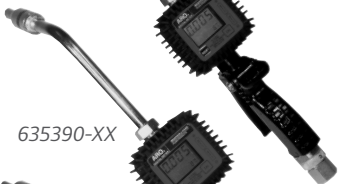

635390-XX



635391-11



635391-1

Digital, Metered Fluid Control Handles *(continued)*

Model	Max flow rate gpm (L)	Meter / totalizing increments	Max working pressure psi (bar)	Fluid NPT (F) in (mm)	inlet
METER ONLY					
635190-1	4 (15)	Pints / gallons	1,000 (69)	1/2" (12.7)	
635190-2	4 (15)	Quarts / gallons	1,000 (69)	1/2" (12.7)	
635190-3	4 (15)	Liters / liters	1,000 (69)	1/2" (12.7)	
METER, CONTROL HANDLES (WITHOUT NOZZLES)					
635390-30	4 (15)	Liters / liters	1,000 (69)	1/2" (12.7)	



635190-X
Order protective boot
74066 separately.

Metered Fluid Control Handles

Model	Units Of measure	Totalizing increments	Working pressure psi (bar)	Inlet size in (mm)	Fluid outlet
PRESET, DIGITAL METERED FLOW CONTROL					
Preset unit automatically shuts off when set quantity of fluid is delivered and meter indicator returns to zero. Totalizer registers up to 9,999 units.					
635360-2	Quarts	Gallons	1,000 (69)	1/2" (12.7)	Non-drip flex extension
635360-22	Quarts	Gallons	1,000 (69)	1/2" (12.7)	Non-drip rigid extension
Preset unit automatically shuts off when set quantity of fluid is delivered and meter indicator returns to zero. Totalizer registers up to 9,999 units.					
635364	1 to 60 quarts	Gallons	1,000 (69)	1/2" (12.7)	9/16" (14.3 mm) diameter non-drip tip
635365	1 to 60 gallons	Gallons	1,000 (69)	1/2" (12.7)	9/16" (14.3 mm) diameter non-drip tip
635367	1 to 60 liters with auto shut-off	Liters	1,000 (69)	1/2" (12.7)	9/16" (14.3 mm) diameter non-drip tip



635360-2

635365

Non-drip Nozzle / Hose

Model	Description	Fluid inlet NPT in (mm)	Length in (mm)	Max working pressure psi (bar)
MOTOR OIL, GEAR OIL, TRANSMISSION FLUID				
629212	Non-drip nozzle / hose	3/4" (19.1)	12" (305)	900 (62)
629226	Non-drip nozzle / hose	1/2" (12.7)	11" (279)	900 (62)
629516	Non-drip nozzle / hose	1/2" (12.7)	13" (330)	1,000 (69)
629521	Right-angle nozzle / hose	1/2" (12.7)	15" (381)	1,000 (69)
6786	Right-angle, rigid, non-drip nozzle	1/4" (6.3)	6-1/2" (165)	1,000 (69)
60798	Rigid, non-drip nozzle	1/2" (12.7)	5-1/2" (133)	1,000 (69)
NOZZLE, FLEXIBLE HOSE, WITH NON-DRIP TIP				
629245-1	Flexhose, non-drip tip	1/2" (12.7)	15" (381)	1,000 (69)
NOZZLE, RIGID TUBE WITH NON-DRIP TIP				
629245-2	Rigid tube, non-drip tip	1/2" (12.7)	13" (330)	1,000 (69)



629212

629226

629516

629521

6786

High-pressure Grease Control Handles

Model	Description	Max working pressure psi (bar)	Fluid inlet NPT (F) in (mm)	Fluid outlet in (mm)
GREASE CONTROL HANDLES				
636101	Dispenses lubrication at line pressure for lubricating grease fittings; does not include nozzle or hydraulic coupler; for applications requiring high-flow capacity; remove the 1/8" (3.2 mm) (M) x 3/8" (9.5 mm) (M) adapter for 3/8" (9.5 mm) (F) porting	7,500 (517)	3/8" (9.5) (F)	11/16" - 16 (17.5) (M) or 1/8" (3.2) NPT (F)
636111	Dispenses lubricant at line pressure for lubricating grease fittings; includes inlet material filter and curved nozzle with hydraulic coupler; remove the 1/8" (3.2 mm) (M) x 3/8" (9.5 mm) (M) adapter for 3/8" (9.5 mm) (F) porting	7,500 (517)	1/8" (3.2) (M) or 3/8" (9.5) (F)	Hydraulic coupler
636103	High-pressure booster handle delivers line pressure for normal lubrication; trigger booster feature delivers 10,000 psi (689 bar) to loose tougher fittings; includes curved nozzle with hydraulic coupler, inlet material filter and manual pressure vent for easy disconnection; do not use with whip hose	7,500 (517)	1/8" (3.2) (M) or 3/8" (9.5) (F)	Hydraulic coupler
WHIP HOSES FOR GREASE CONTROL HANDLES*				
629742	Extra-long, wire braid (624201-02) whip hose with hydraulic coupler and swivel; overall length of 29-1/2" (749 mm); for use with coupler 636111 high-pressure control handle; allows operator to access hard-to-reach fittings	5,000 (345)	1/8" (3.2) (F)	636046 hydraulic

*WARNING: Not for use with 636103 high-pressure booster handle.

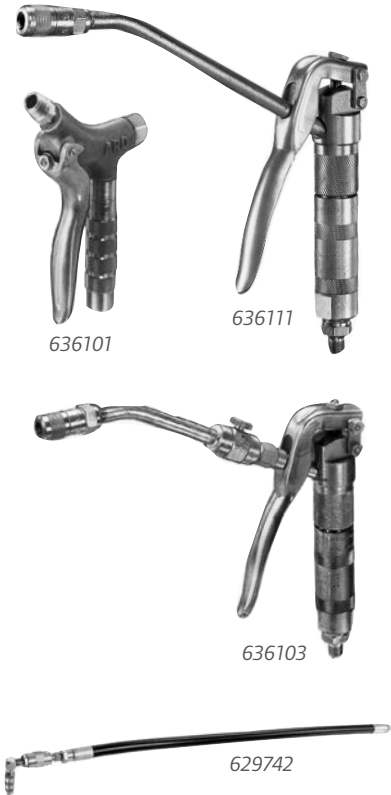

Specialty Application Control Handle

Model	Description
WATER, ANTIFREEZE, WINDSHIELD FLUID	
635129	Fluid dispensing nozzle — 635129 bibb with trigger 1/4" (6.3 mm) NPT(F) inlet, zinc die casting with brass, and nitrile seals for water or oil service; radiator-type bibb has 1/4" (6.3 mm) fluid inlet and non-drip tip



Hand-operated Pumps

Motor Oil, Gear Oil, Transmission Fluid

Model	Description
5-GAL	
611170	Capable of high-volume delivery; includes 621597-5 hose / dispensing, 2:1, 4:1, 7:1 nozzle assembly with 5' (1.5 m), 1/2" (12.7 mm) ID hose and 72006 drum cover



611170
Container not included.

Grease Gun Accessories

Button head coupler

636020

Standard button coupler. Can be converted to either push-on or pull-on.

636024

Standard button coupler. Can be converted to either push-on or pull-on.



Model	Inlet thread connection in (mm)	Length in (mm)	Max working pressure psi (bar)
636020	7/16" - 27 (11.1) (F)	-	8,000 (552)
636024	1/8" (3.2) NPT (F)	-	8,000 (552)
636027	1/8" (3.2) NPT (F)	1-5/8" (41)	6,000 (414)
636028	1/8" (3.2) NPT (F)	1-5/8" (41)	10,000 (689)
636046	1/8" (3.2) NPT (F)	1-7/16" (37)	6,000 (414)

Standard Hydraulic Couplers

636027

Small-diameter hydraulic coupler.



636028

Reversible jaw hydraulic coupler.



636046

Small-diameter hydraulic coupler with ball check.

Swivels

Model	Thread Size NPT x NPT in	Type of Seals	Max Working Pressure psi (bar)
STRAIGHT SWIVEL			
636075	1/8" (M) x 1/8" (F)	Fabric with neoprene	10,000 (689.4)
636085	3/8" (M) x 3/8" (F)	Fabric with neoprene	10,000 (689.4)
635107	3/8" (M) x 1/2" (F)	Fabric with neoprene	2,000 (137.8)
635117	1/2" (M) x 1/2" (F)	Fabric with neoprene	2,000 (137.8)
635108	3/4" (M) x 3/4" (F)	Fabric with neoprene	1,000 (68.9)
Z 360° SWIVEL			
636077	1/8" (M) x 1/8" (F)	Fabric with neoprene	10,000 (689.4)
636083	1/8" (F) x 3/8" (F)	Fabric with neoprene	10,000 (689.4)
636084	1/8" (F) x 1/4" (F)	Fabric with neoprene	10,000 (689.4)
636086-B	1/4" (F) x 1/4" (M)	Fabric with neoprene	6,700 (461.8)
636087-B	1/4" (F) x 1/4" (M)	Fabric with neoprene	6,700 (461.8)
Includes 67176-5 edge-type filter element			
636088	3/8" (M) x 3/8" (F)	Fabric with neoprene	10,000 (689.4)
635106	1/2" (F) x 3/8" (M)	Fabric with neoprene	10,000 (689.4)



Grease Fitting Accessories

Model	Description	Thread size NPT in (mm)	Height in (mm)
STRAIGHT			
6000	Straight	1/8" (3.2) (M)	21/32" (16.7)
6001	Straight	1/8" (3.2) (M)	1-1/4" (31.7)
6026	Straight	1/4" (6.3) (M)	7/8" (22.2)
6010	Long straight	1/4" - 28 (6.3)	11/16" (17.5)
ELBOW			
6005	45° elbow	1/8" (3.2) (M)	7/8" (22.2)
6011	45° elbow (short)	1/4" - 28 (6.3)	13/16" (20.6)
DRIVE TYPE FITTINGS			
6060	Straight	5/16" (7.9) serrated	5/8" (15.9)
6069	Straight	3/16" (4.8) serrated	19/32" (15.1)
ELBOW BODIES			
6045	90° elbow	1/8" (3.2) (M) x 1/8" (3.2) (F)	1" (25.4)

Model	Description
GREASE FITTING EASY-OUT TOOLS	
636053	Four-function tool <ul style="list-style-type: none"> • Easy-out for removing broken fittings • 1/8" (3.2 mm) NPT tap • 3/8" (9.5 mm) socket for removing hydraulic fittings • 7/16" (11.1 mm) socket for removing hydraulic fittings
636054	Four-function tool <ul style="list-style-type: none"> • Easy-out for removing broken fittings • 1/4"-28 (6.3 mm) tap • 5/16" (7.9 mm) socket for removing hydraulic fittings • 3/8" (9.5 mm) socket for removing hydraulic fittings



General Installation Accessories

Overrun Controls

Model	Air inlet NPT(F) in (mm)	Air outlet NPT(F) in (mm)	Pressure range psi (bar)	For use with
ARO-STOP® VALVES				
ARO-STOP® valves shut off air to pump when material container is empty or fluid line is broken. Both have quick-set and reset features.				
635040	1/4" (6.3)	1/4" (6.3)	20 – 175 (1.4 – 12.1)	LM Series and (1.4 - 12) 61204X-X Pumps and 1/2" (12.7 mm) diaphragm pump (includes connecting hose)
(max flow rate of 23 scfm @ 90 psi)				
23644-400	1/2" (12.7)	1/2" (12.7) NPT (M)	20 – 175 (1.4 – 12.1)	AFX Series only (1.4 - 12) and 1" (25.4 mm) diaphragm pump



Protect your investment

Pump run away happens when a material container is depleted and the pump cycles fast and needlessly. It's not good. So, protect your pump investment with an ARO-STOP® valve.



635040



23644-400

Pressure Relief Valve / Valve Kit

Model	Description
PRESSURE RELIEF VALVE / VALVE KITS	
61117	Pressure relief valve is used on material outlet side of pump to automatically allow bleed-back of material to container in applications where thermal expansion is present.
61118	Pressure relief valve kit includes 61117 relief valve, reducing bushing, compression coupling, 3' (0.9 m) of plastic drain tubing, and grommet (for drum attachment)

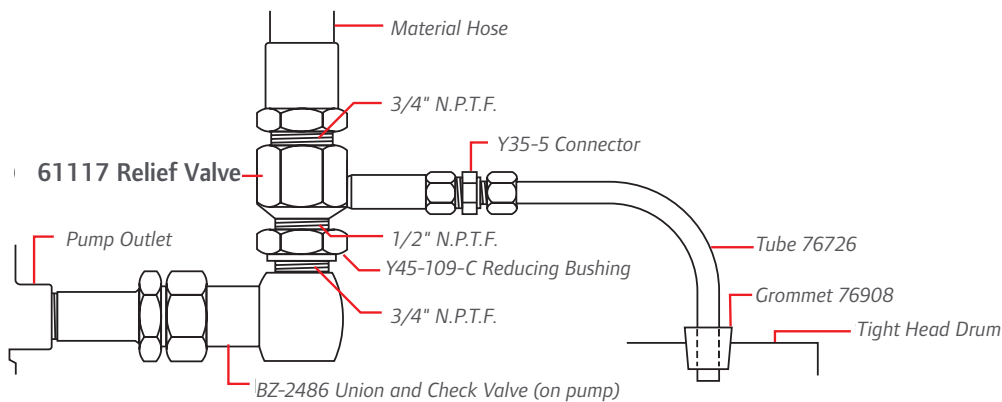

General Installation Accessories

General Accessories

640058-2

Dolly for 16-gal (60.6 L) keg.

94421

Drum cover for 16-gal (60.6 L) keg.

640165

Follower plate for 3" (76.2 mm) LM Series and 120-lb (54.4 kg) container. For use with LM Series grease.

640015-1

Follower plate for 3" (76.2 mm) LM Series and 400-lb (181.4 kg) container. For use with LM Series grease.



640015-1

640095-1-B

Follower plate for 2" (50.8 mm) Thunder Series and 35-lb (15.9 kg) container. For use with LM Series grease.



640095-2-B

640095-2-B

Follower plate for 3" (76.2 mm) LM Series and 35-lb (15.9 kg) container. For use with LM Series grease.

67145-2

Bung adapter for 3" (76.2 mm) LM Series grease pump. For use with LM Series grease.



67145-X

67145-3-B

Bung adapter for 2" (50.8 mm) LM Series oil pump. For use with LM Series oil.



67145-X-B

67145-4-B

Bung adapter for 3" (76.2 mm) LM Series oil pump. For use with LM Series oil.

61118

Pressure relief valve kit.

77617

Oil tapper fitting (converts oil tapper to 1/2", 12.7 mm inlet).

640164

Tie-down kit for 16-gal / 120-lb (60.6 L / 54.4 kg) containers.

71027-1

Tie-down kit for 55-gal / 400-lb (208.1 L / 181.4 kg) containers.

Dispensing Accessories

621516-10

10' (3.0 m) hose and dispensing bibb for use with diaphragm pump.



621516-10

635129

Dispensing bibb for use with diaphragm pump.

621523-10

10' (3.0 m) hose with no-drip nozzle. For use with diaphragm pump.



621523-10

95189

Poly cam coupler 1/2" (12.7 mm) NPT (M)

95190

Aluminum cam coupler 1/2" (12.7 mm) NPT (M)

Installation Accessories

65986-1

Siphon tube with 6' (1.8 m) hose for 55-gal (208.1 liter) drum with 2" (50.8 mm) bung. For use with LM Series and diaphragm pumps.

61601

Siphon tube with 6' (1.8 m) hose for 55-gal (208.1 liter) drum for wall-mounted pump. For use with LM Series pump.



61601

66779

Siphon tube for 55-gal (208.1 liter) drum. For use with LM Series and diaphragm pumps.

66779-1

Siphon tube for 55-gal (208.1 liter) drum. For use with LM Series and diaphragm pumps.

66779-2

Siphon tube with 6' (1.8 m) hose for AFX Series container. For use with LM Series and diaphragm pumps.

622701-6

6' (1.8 m) siphon hose. For use with LM Series and diaphragm pumps.

61113

Wall-mount for stub pumps. For use with LM Series pump.

61412

Siphon tube for 1/2" (12.7 mm) diaphragm pump.

76763

Wall-mount for 1/2" (12.7 mm) diaphragm pumps.

66100

Wall-mount for 1" (25.4 mm) diaphragm pumps.



Accessories

HIGH AND LOW PRESSURE

High-pressure Hose

Model	ID in (mm)	OD in (mm)	Fitting threads both ends in (mm)	Max pressure psi (bar)	Length ft (m)
BUNA-N TUBE, NEOPRENE COVER					
1-WIRE BRAID					
623501-2	1/2" (12.7)	29/32" (23.0)	1/2" (12.7) NPT (M)	2,000 (138)	2' (0.6)
623501-5	1/2" (12.7)	29/32" (23.0)	1/2" (12.7) NPT (M)	2,000 (138)	5' (1.5)
623501-6	1/2" (12.7)	29/32" (23.0)	1/2" (12.7) NPT (M)	2,000 (138)	6' (1.8)
623501-8	1/2" (12.7)	29/32" (23.0)	1/2" (12.7) NPT (M)	2,000 (138)	8' (2.4)
2-WIRE BRAID					
624201-2	1/4" (6.3)	11/16" (17.5)	1/8" (3.2) NPT (F)	5,000 (345)	2' (0.6)
624201-6	1/4" (6.3)	11/16" (17.5)	1/8" (3.2) NPT (F)	5,000 (345)	6' (1.8)
624201-10	1/4" (6.3)	11/16" (17.5)	1/8" (3.2) NPT (F)	5,000 (345)	10' (3)
624201-30	1/4" (6.3)	11/16" (17.5)	1/8" (3.2) NPT (F)	5,000 (345)	30' (9.1)
624401-4	3/8" (9.5)	27/32" (21.4)	3/8" (9.5) NPT (M)	4,000 (276)	4' (1.2)
624401-8	3/8" (9.5)	27/32" (21.4)	3/8" (9.5) NPT (M)	4,000 (276)	8' (2.4)
624601-4	3/4" (19.1)	1-1/4" (31.7)	3/4" (19.1) NPT (M)	2,250 (155)	4' (1.2)
ELASTOMER TUBE, POLYESTER COVER					
1-WIRE BRAID					
628067-3	1" (25.4)	1-1/4" (31.7)	1" (25.4) NPT (M)	800 (55)	3' (0.9)

In selecting a hose, be sure the hose material is compatible with the fluid being pumped and that the maximum working pressure will not be exceeded in the application. Only those hose length options listed with each model are available. Substitute -XX with -5, -15, -25, etc., to indicate length selection. (Example: Substitute -XX with length selection, such as -50. If length is single digit, use that digit only. Do not add zeros.)

***CAUTION: These hoses cannot be used with 100:1 ratio pumps.**

Never use a hose with a maximum pressure rating lower than the highest pressure the pump can generate.

Low-pressure Hose

Model	ID in (mm)	OD in (mm)	Fitting threads both ends in (mm)	Max pressure psi (bar)	Length ft (m)
NEOPRENE TUBE, NEOPRENE COVER					
2-FABRIC BRAID					
622651-5	3/4" (19.1)	1-3/16" (30.2)	3/4" (19.1) NPT (M)	600 (41)	5' (1.5)
622651-6	3/4" (19.1)	1-3/16" (30.2)	3/4" (19.1) NPT (M)	600 (41)	6' (1.8)
622651-10	3/4" (19.1)	1-3/16" (30.2)	3/4" (19.1) NPT (M)	600 (41)	10' (3)
622651-15	3/4" (19.1)	1-3/16" (30.2)	3/4" (19.1) NPT (M)	600 (41)	15' (4.6)
BUNA-N TUBE, NEOPRENE COVER					
2-FABRIC BRAID					
622201-3	1/4" (6.3)	5/8" (15.9)	1/4" (6.3) NPT (M)	250 (17)	3' (0.9)
622201-5	1/4" (6.3)	5/8" (15.9)	1/4" (6.3) NPT (M)	250 (17)	5' (1.5)
622201-25	1/4" (6.3)	5/8" (15.9)	1/4" (6.3) NPT (M)	250 (17)	25' (7.6)



Accessories

VALVES / COUPLINGS

Fluid Control Valves

Model	Inlet outlet NPT in (mm)	Body material	Seat material	Max working pressure psi (bar)
BALL VALVES				
Used to control the on-off flow of fluid material or air. Select proper working pressure and material compatibility for application.				
66592	1/2" (12.7) (F)	Carbon steel	PTFE	2,000 (138)
66593	3/8" (9.5) NPS (M) x 3/8" (9.5) (M)	303 stainless steel	PTFE	4,000 (276)
PLUG VALVES				
Y28-1	1/4" (6.3) (F)	Brass	N/A	150 (10)
Y28-2	1/8" (3.2) (F)	Brass	N/A	150 (10)
NEEDLE VALVES				
92818	1/4" (6.3) (F) x 1/4" (6.3) (M)	Brass	Leather	125 (9)
GLOBE VALVES				
Y26-1	3/4" (19.1) (F)	Brass	Graphite	125 (9)
BALL VALVES				
104077-2	1/4" (6.3) (F)	Nickel-plated brass	PTFE	225 (16)
104077-3	3/8" (9.5) (F)	Nickel-plated brass	PTFE	225 (16)
104077-4	1/2" (12.7) (F)	Nickel-plated brass	PTFE	225 (16)



66592



Y28-1

Fittings

Model	Thread size NPT in (mm)	Material of construction
STRAIGHT COUPLINGS — 150 PSI (10 BAR) MAX		
6,750 PSI (446 BAR) MAX		
77617	3/8" (9.5) (M) x 1/2" (12.7) (M)	Zinc-plated steel
5,000 PSI (345 BAR) MAX		
76751	1/4" (6.3) (M) x 11/16"-16 (17.5) (M)	Steel
8,000 PSI (552 BAR) MAX		
2722	1/8" (3.2) (M) x 11/16"-16" (17.5) (M)	Steel
73581	1/4" (6.3) (M) x 3/8" (9.5) (M)	Steel
76493	1/8" (3.2) (M) x 3/8" (9.5) (M)	Steel
REDUCING BUSHINGS — 150 PSI (10 BAR) MAX		
Y45-5-C	1/4" (6.3) (F) x 1/2" (12.7) (M)	Iron
Y45-9-C	1/2" (12.7) (F) x 3/4" (19.1) (M)	Iron



77617

Fittings *(continued)*

Model	Thread size NPT in (mm)	Material of construction
3,000 PSI (207 BAR) MAX		
Y45-102-C	1/8" (3.2) (F) x 3/8" (9.5) (M)	Steel
Y45-105-C	1/4" (6.3) (F) x 1/2" (12.7) (M)	Steel
Y45-106-C	3/8" (9.5) (F) x 1/2" (12.7) (M)	Steel
Y45-109-C	1/2" (12.7) (F) x 3/4" (19.1) (M)	Steel
10,000 PSI (690 BAR) MAX		
6788	1/4" (6.3) (F) x 1/2" (12.7) (M)	Steel
STREET ELBOWS — 150 PSI (10 BAR) MAX		
Y43-1-C	1/8" (3.2) (M) x 1/8" (3.2) (F)	Iron
Y43-2-C	1/4" (6.3) (M) x 1/4" (6.3) (F)	Iron
Y43-4-C	1/2" (12.7) (M) x 1/2" (12.7) (F)	Iron
Y43-5-C	3/4" (19.1) (M) x 3/4" (19.1) (F)	Iron
Y43-6-C	1" (25.4) (M) x 1" (25.4) (F) plated	Iron
STRAIGHT COUPLINGS — 150 PSI (10 BAR) MAX		
Y43-44	1/2" (12.7) (F) x 1/2" (12.7) (F)	Iron
Y43-48-C	1-1/2" (38.1) (F) x 1-1/2" (38.1) (F)	Iron
REDUCING COUPLINGS — 8,000 PSI (552 BAR) MAX		
4280	1/8" (3.2) (F) x 3/8" (9.5) (F)	Steel
SHORT NIPPLES — 150 PSI (10 BAR) MAX		
Y27-2-C	1/4" (6.3) (M) x 1/4" (6.3) (M)	Plated iron
Y27-52-C	1/4" (6.3) (M) x 1/4" (6.3) (M)	Plated iron
Y27-54-C	1/2" (12.7) (M) x 1/2" (12.7) (M)	Plated iron
Y27-55-C	3/4" (19.1) (M) x 3/4" (19.1) (M)	Plated iron
Y27-56-C	1" (25.4) (M) x 1" (25.4) (M)	Plated iron
Y27-58-C	1-1/2" (38.1) (M) x 1-1/2" (38.1) (M)	Plated iron
8,000 PSI (552 BAR) MAX		
676	1/8" (3.2) (M) x 1/8" (3.2) (M)	Steel
1950	1/4" (6.3) (M) x 1/4" (6.3) (M)	Steel
70749	1/2" (12.7) (M) x 1/2" (12.7) (M)	Steel
LONG NIPPLES — 150 PSI (10 BAR) MAX		
LENGTH — 2" (51 MM)		
Y44-11-C	1/4" (6.3)	Plated iron
LENGTH — 2-1/2" (63.5 MM)		
Y44-12-C	1/4" (6.3)	Plated iron
ELBOWS — 150 PSI (10 BAR) MAX		
Y43-12-C	1/4" (6.3) (F) x 1/4" (6.3) (F)	Iron
Y43-15-C	3/4" (19.1) (F) x 3/4" (19.1) (F)	Iron
3,000 PSI (207 BAR) MAX		
Y43-214-N	1/2" (12.7) (F) x 1/2" (12.7) (F)	Steel
Y43-215	3/4" (19.1) (F) x 3/4" (19.1) (F)	Steel



Y45-106-C



Y43-2-C



Y43-44



4280



676



Y43-214-N

Fittings (continued)

Model	Thread size NPT in (mm)	Material of construction	Max pressure psi (bar)
SWIVEL UNIONS			
75364	1/4" (6.3) (M) x 1/4" (6.3) (F)	Steel	10,000 (690)
75366	1/2" (12.7) (M) x 1/2" (12.7) (F)	Steel	6,750 (466)
75367	3/4" (19.1) (M) x 3/4" (19.1) (F)	Steel	4,375 (302)
75368	1" (25.4) (M) x 1" (25.4) (F)	Steel	3,550 (245)
75369	1/4" (6.3) (F) x 1/4" (6.3) (F)	Steel	10,000 (690)
PLAIN TEE — FEMALE			
Y43-32-C	1/4" (6.3) x 1/4" (6.3) x 1/4" (6.3)	Iron	150 (10)
Y43-233-C	3/8" (9.5) x 3/8" (9.5) x 3/8" (9.5)	Steel	3,000 (207)
PIPE PLUGS — MALE			
Y17-50	1/8" (3.2) countersunk (hex)	Steel	10,000 (690)
Y17-51	1/4" (6.3) countersunk (hex)	Steel	10,000 (690)
FEMALE ADAPTER			
4280	3/8" (9.5) (F) x 1/8" (3.2) NPT (F)	Steel	8,000 (552)
ADAPTER UNIONS			
Y167-3	1/2" (12.7) (F) x 3/8" (9.5) NPT (M)	Steel	6,000 (414)
Y167-4	3/4" (19.1) (F) x 1/2" (12.7) NPT (M)	Steel	5,000 (345)
Y167-5	1/2" (12.7) (F) x 1/4" (6.3) NPT (M)	Steel	6,000 (414)
4295	1/8" (3.2) PTF SAE short (F) x 7/16"-27 (11.1) (M)	Steel	8,000 (552)
4616	1/2" (12.7) (F) x 1-3/8"-18 (34.9) (M)	Steel	8,000 (552)



75364



Y43-233-C



Y17-10



92021

Fluid Couplers

Model	Description
92021	Quick connect fluid coupler (female) — 3/4" (19.1) NPT (F) couples with 92022 fluid connector

WARNING: To ensure safe operation, be sure the maximum working pressure of your fluid handling system does not exceed the maximum working pressure of the fittings.

Fluid Ball Check Unions

Model	Body material	Ball material	Seat material	Inlet NPT in (mm)	Outlet NPT in (mm)	Max working pressure psi (bar)
66559	Carbon steel	440C stainless steel	440 F stainless steel	1" (25.4) (M)	1" (25.4) (F)	8,000 (552)



66559

Used to prevent back flow of material.

 <p>1/8" and 1/4" Ports Max Inlet Press: Poly bowl 150 psi Metal bowl 250 psi Series size: Miniature</p>	 <p>1/4" and 3/8" Ports Max Inlet Press: Poly bowl 150 psi Metal bowl 250 psi Series size: Compact</p>	 <p>3/8", 1/2" and 3/4" Ports Max Inlet Press: Poly bowl 150 psi Metal bowl 250 psi Series size: Standard</p>	 <p>3/4" and 1" Ports Max Inlet Press: Metal bowl 250 psi Series size: Heavy Duty</p>	 <p>1", 1-1/4", 1-1/2", 2" and 3" Ports Max Inlet Press: Filter Metal bowl 300 psi Lubricator Metal bowl 200 psi Series size: Super Duty</p>
---	---	--	--	--

- ▶ **SAFETY:** Designed with locking bowls and clear multilingual markings
- ▶ **BEST-IN-CLASS AIR FLOW PERFORMANCE:**
 38% better than the competition
- ▶ **MODULARITY:** All ARO-Flo products are designed to integrate with each other
- ▶ **QUICK ASSEMBLY:** Can be easily, safely and quickly assembled or disassembled with a minimum of tools – no fuss or complications

	1/8" Port Size	1/4" Port Size	3/8" Port Size	1/2" Port Size	3/4" Port Size	1" Port Size	1-1/2" Port Size	2" Port Size
1000 Series	46 scfm*							
1500 Series		85 scfm*						
2000 Series			150 scfm*					
3000 Series					215 scfm*			
Super Duty Series						1200 scfm		
Specialty Regulators	Precision, Stainless Steel and Brass Regulators							

* Flow rates based off of Filter/Regulator/Lubricator combination unit. Individual units flow rates are higher.



- | | |
|---------------------------------|------------------------------|
| 1 Modular Pipe Adapter | 7 Regulator |
| 2 T-Brackets | 8 ARO-Flo Check Valve |
| 3 Modular Spacers | 9 Manifold Port Block |
| 4 Modular Lock-Out Valve | 10 Pressure Switch |
| 5 Soft-Start Valve | 11 Lubricator |
| 6 Filter w/indicator | |



Ingersoll Rand attests that ARO-Flo Series of filters, regulators, lubricators (1000, 1500, 2000, 3000 Series) and select accessories are out of scope for ATEX Directive 94/9/EEC or 2014/34/EU. The products listed in IRITS-1215-197 certificate can be used in group II, category 2 environment; Gas and Dust with temperature a T6 (Ex II 2GD T6) if all conditions set up in the Instruction Manual are met. Instruction Manuals and certificate regarding ATEX Declaration can be found at AROZONE.COM

► **Piston Pump Selection Guide** *(Most popular)*

Pump Motor Size	Filter Metal Bowl w/Sight Glass	Regulator	Piggyback, Poly Bowl w/Guard	Piggyback, Poly Bowl w/Guard, Auto Drain	Piggyback, Metal Bowl w/Sight Glass	Piggyback, Metal w/ Sight Glass, Auto Drain	FRL Combo (3 Piece) Metal Bowl w/Sight Glass	F/R-L Combo (2 Piece) Metal Bowl w/Sight Glass	FRL Port Size
2"	F35221-410	R37221-600	<i>P39224-600</i>	<i>P39224-604</i>	<i>P39224-610</i>	P39224-614	C38221-810	<i>C38221-610</i>	1/4" NPT
3"	F35221-410	R37221-600	<i>P39224-600</i>	<i>P39224-604</i>	<i>P39224-610</i>	P39224-614	C38221-810	<i>C38221-610</i>	1/4" NPT
4.25"	F35341-410	R37341-600	<i>P39344-600</i>	<i>P39344-604</i>	<i>P39344-610</i>	P39344-614	C38341-810	<i>C38341-610</i>	1/2" NPT
6"	F35341-410	R37341-600	<i>P39344-600</i>	<i>P39344-604</i>	<i>P39344-610</i>	P39344-614	C38341-810	<i>C38341-610</i>	1/2" NPT
8"	F35351-410	R37351-600	<i>P39354-600</i>	<i>P39354-604</i>	<i>P39354-610</i>	P39354-614	C38351-810	<i>C38351-610</i>	3/4" NPT
10"	F35451-410	R37451-600			<i>P39454-610</i>	P39454-614	C38451-810	<i>C38451-610</i>	3/4" NPT
12"	F35451-410	R37451-600			<i>P39454-610</i>	P39454-614	C38451-810	<i>C38451-610</i>	3/4" NPT

2"	F352B1-410	R372B1-600	<i>P392B4-600</i>	<i>P392B4-604</i>	<i>P392B4-610</i>	P392B4-614	C382B1-810	<i>C382B1-610</i>	1/4" BSP
3"	F352B1-410	R372B1-600	<i>P392B4-600</i>	<i>P392B4-604</i>	<i>P392B4-610</i>	P392B4-614	C382B1-810	<i>C382B1-610</i>	1/4" BSP
4.25"	F353D1-410	R373D1-600	<i>P393D4-600</i>	<i>P393D4-604</i>	<i>P393D4-610</i>	P393D4-614	C383D1-810	<i>C383D1-610</i>	1/2" BSP
6"	F353D1-410	R373D1-600	<i>P393D4-600</i>	<i>P393D4-604</i>	<i>P393D4-610</i>	P393D4-614	C383D1-810	<i>C383D1-610</i>	1/2" BSP
8"	F353E1-410	R373E1-600	<i>P393E4-600</i>	<i>P393E4-604</i>	<i>P393E4-610</i>	P393E4-614	C383E1-810	<i>C383E1-610</i>	3/4" BSP
10"	F354E1-410	R374E1-600			<i>P394E4-610</i>	P394E4-614	C384E1-810	<i>C384E1-610</i>	3/4" BSP
12"	F354E1-410	R374E1-600			<i>P394E4-610</i>	P394E4-614	C384E1-810	<i>C384E1-610</i>	3/4" BSP

► **Diaphragm Pump Selection Guide** *(Most popular)*

Pump Size	Coalescing Filter Metal Bowl w/Sight Glass	Regulator	Piggyback, Poly Bowl w/Guard	Piggyback, Poly Bowl w/Guard, Auto Drain	Piggyback, Metal Bowl w/Sight Glass	Piggyback Metal Bowl w/Sight Glass, Auto Drain	FRL Combo (3 Piece) Metal Bowl w/Sight Glass	FRL Combo (2 Piece) Metal Bowl w/Sight Glass	FRL Port Size
1/4", 3/8", 1/2", 3/4"	F35121-320	R37121-600	<i>P39124-600</i>	<i>P39124-604</i>	<i>P39124-620</i>	P39124-624	C38121-820	C38121-620	1/4" NPT
1"	F35221-310	R37221-600	<i>P39224-600</i>	<i>P39224-604</i>	<i>P39224-610</i>	P39224-614	C38221-810	C38221-610	1/4" NPT
3:1 Ratio	F35341-310	R37341-600	<i>P39344-600</i>	<i>P39344-604</i>	<i>P39344-610</i>	P39344-614	C38341-810	C38341-610	1/2" NPT
1-1/2"	F35341-310	R37341-600	<i>P39344-600</i>	<i>P39344-604</i>	<i>P39344-610</i>	P39344-614	C38341-810	C38341-610	1/2" NPT
2"	F35351-310	R37351-600	<i>P39354-600</i>	<i>P39354-604</i>	<i>P39354-610</i>	P39354-614	C38351-810	C38351-610	3/4" NPT
3"	F35451-410	R37451-600			<i>P39454-610</i>	P39454-614	P39454-611	C38451-810	3/4" NPT

1/4", 3/8", 1/2", 3/4"	F351B1-420	R371B1-600	<i>P391B4-600</i>	<i>P391B4-604</i>	<i>P391B4-620</i>	P391B4-624	C381B1-820	C381B1-620	1/4" BSP
1"	F352B1-410	R372B1-600	<i>P392B4-600</i>	<i>P392B4-604</i>	<i>P392B4-610</i>	P392B4-614	C382B1-810	C382B1-610	1/4" BSP
3:1 Ratio	F353D1-410	R373D1-600	<i>P393D4-600</i>	<i>P393D4-604</i>	<i>P393D4-610</i>	P393D4-614	C383D1-810	C383D1-610	1/2" BSP
1-1/2"	F353D1-410	R373D1-600	<i>P393D4-600</i>	<i>P393D4-604</i>	<i>P393D4-610</i>	P393D4-614	C383D1-810	C383D1-610	1/2" BSP
2"	F353E1-410	R373E1-600	<i>P393E4-600</i>	<i>P393E4-604</i>	<i>P393E4-610</i>	P393E4-614	C383E1-810	C383E1-610	3/4" BSP
3"	F354E1-410	R374E1-600			<i>P394E4-610</i>	P394E4-614	P394E4-611	C384E1-810	3/4" BSP

Warranty

AIR SYSTEMS COMPONENTS AND LUBRICATION EQUIPMENT

Air Systems Components Warranty

Ingersoll Rand® Fluid Products warrants to the original-use purchaser of the Ingersoll Rand® / ARO® air systems components depicted in this catalog that Ingersoll Rand® will repair or replace, free of charges, including return shipping costs within the continental United States of America, any such product that under normal use and service proves defective in material or workmanship, as determined by Ingersoll Rand inspection, two years from date of purchase, provided the claimed defective product, or part thereof, is promptly returned to the Ingersoll Rand® Service Repair Center or a factory-authorized service repair center, with transportation charges prepaid.

If Ingersoll Rand® inspection discloses no defect in material or workmanship, repair or replacement and return will be made at customary charges.

The foregoing warranty supersedes, voids, and is in lieu of all or any other warranties, expressed or implied, and no warranty of merchantability or fitness for particular purpose is intended or made. The sole obligation of Ingersoll Rand® and the sole remedy of the original-use purchaser is as stated above and in no event shall Ingersoll Rand® be liable for any special, direct, indirect, incidental, consequential; or other damages or expenses of any nature including, without limitation, loss of profits or production time incurred by the original-use purchaser or any other party.

Lubrication Equipment Warranty

Ingersoll Rand® warrants to the original-use purchaser of the products depicted in this catalog that Ingersoll Rand® will repair or replace, free of charges, including return shipping costs within the continental United States of America, any such product that under normal use and service proves defective in material and workmanship, as determined by Ingersoll Rand® inspection, within (A) one year from date of purchase of said products, other than the following, (B) five years from date of purchase of LM and LP Series pumps, (C) five years from date of purchase of a diaphragm pump, and (D) five years from date of purchase of Ingersoll Rand / ARO®-manufactured swivels, non-metered control handles, 4-1/4", 6", 8" pumps, drains, follower plates, tie-downs, siphon tubes, and drum covers, provided the claimed defective product, or part thereof, is promptly returned to the Ingersoll Rand® factory or Customer Service Center with transportation charges prepaid.

This warranty does not cover failure of parts or components due to normal wear or damage, or wear that in the judgement of Ingersoll Rand® / ARO® arises from misuse, abrasion, corrosion, negligence, accident, substitution of non-Ingersoll Rand® / ARO® parts, faulty installation, or tampering.

If Ingersoll Rand® inspection discloses no defect in material or workmanship, repair or replacement and return will be made at customary charges.

Equipment not covered by Ingersoll Rand® warranty: accessories or components of equipment sold by Ingersoll Rand that are not manufactured by Ingersoll Rand® (such as switches, hoses, meters, etc.) are subject to the warranty, if any, of their manufacturer. Ingersoll Rand® will provide the purchaser with reasonable assistance in making such claims.

The foregoing warranty supersedes, voids, and is in lieu of all or any other warranties, expressed or implied, and no warranty of merchantability or fitness for particular purpose is intended or made. The sole obligation of Ingersoll Rand® and the sole remedy of the original-use purchaser is as stated above and in no event shall Ingersoll Rand® be liable for any special, direct, indirect, incidental, consequential, or other damages or expenses of any nature including, without limitation, loss of profits or production time incurred by the original-use purchaser or any other party.



About ARO®

ARO® is a worldwide manufacturer of fluid management products that are skillfully engineered to deliver performance and serviceability, allowing success to flow freely in our customers' businesses. That's why ARO® is fluid intelligence—the smart choice in fluid management products for industrial operations.

With over an 85-year legacy of premier product performance and service excellence, ARO® provides fluid management equipment for customers and industries around the globe, including chemical, manufacturing, energy, pharmaceutical, mining and more.

ARO® has the right product to meet our customers' specific needs. We offer air-operated diaphragm pumps, piston pumps and packages, filters, regulators, and lubricators (FRLs), lubrication equipment, and pneumatic valves and cylinders.

ARO®

Distributed by:

www.AROzone.com

arotechsupport@irco.com

youtube.com/aropumps

(800) 495-0276



IRCO.com

Ingersoll Rand (NYSE:IR), driven by an entrepreneurial spirit and ownership mindset, is committed to helping make life better. We provide innovative and mission-critical industrial, energy, medical and specialty vehicle products and services across 40+ respected brands designed to excel in even the most complex and harsh conditions where downtime is especially costly. Our employees connect to customers for life by delivering proven expertise, productivity and efficiency improvements.

We are committed to using environmentally conscious print practices

©2016 Ingersoll Rand

IRITS-1016-204 EN 0919