



LMI[®]

an Accudyne Industries brand



ROYTRONIC EXCEL™ Series AD Electronic Metering Pumps

Instruction Manual/Programming Guide

Manual No : 2024

Rev. : E

Rev. Date : 11/2015

BPE BURT | PROCESS
EQUIPMENT

FOR SALES AND SUPPORT CALL
TOLL FREE 877-742-2878

Return to BurtProcess.com



LMI[®]

an Accudyne Industries brand

Model AD 2 5 1 - 8 3 8 S I

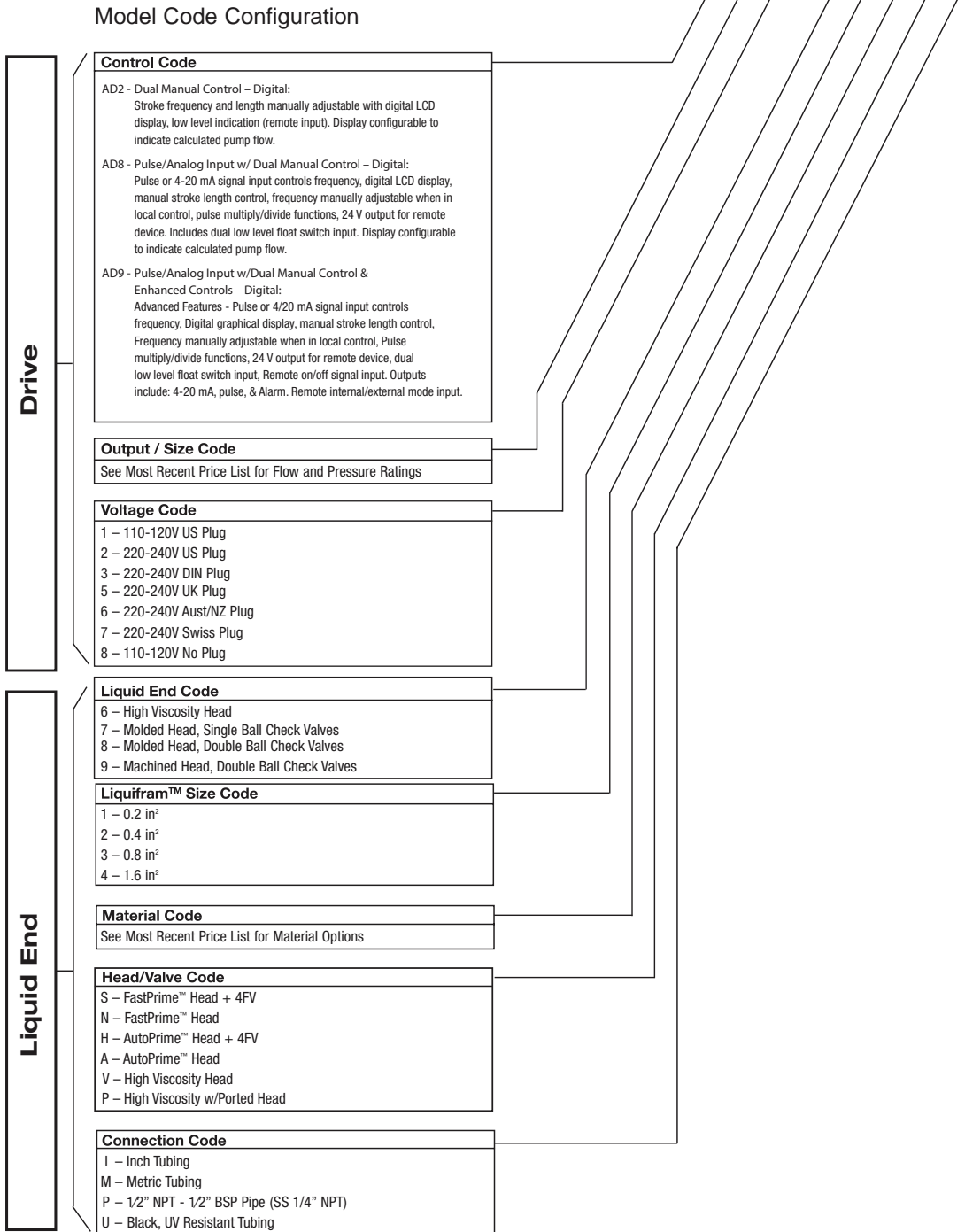

**Note: Not all configurations are available. Please See your local distributor or price list for available options.*

ROYTRONIC EXCEL™ Series AD

PRECAUTIONS

The following precautions should be taken when working with LMI® metering pumps. Please read this section carefully prior to installation.

Protective Clothing



ALWAYS wear protective clothing, face shield, safety glasses and gloves when working on or near your metering pump. Additional precautions should be taken depending on the solution being pumped. Refer to SDS precautions from your solution supplier.

Water Pre-Prime



All LMI® pumps are pre-primed with water when shipped from the factory. If your solution is not compatible with water, disassemble the Pump Head Assembly. Thoroughly dry the pump head, valves, seal rings, balls and LIQUIFRAM™ (diaphragm). Reassemble head assembly tightening screws in a crisscross pattern. Refill the pump head with the solution to be pumped before priming the pump. (This will aid in priming.)

Liquid Compatibility



The evaluation performed by UL was tested with water only. LMI® pumps are tested to NSF 50 for use on muriatic acid (40%) and sodium hypochlorite (12.5%). The pumps are certified to NSF 61 with: sodium hypochlorite (12.5%), sulfuric acid (98.5%), sodium hydroxide (50%), and hydrochloric acid (30%). Determine if the materials of construction included in the liquid handling portion of your pump are adequate for the solution (chemical) to be pumped. Always refer to the solution supplier and the LMI® Chemical Resistance Chart for compatibility of your specific LMI® metering pump. Contact your local LMI® distributor for further information.

Tubing Connections



Inlet and outlet tubing or pipe sizes must not be reduced. Make certain that all tubing is SECURELY ATTACHED to fittings prior to start-up (see Section 2.3, Tubing Connections). ALWAYS use LMI® supplied tubing with your pump, as the tubing is specifically designed for use with the pump fittings. It is recommended that all tubing be shielded to prevent possible injury in case of rupture or accidental damage. If tubing is exposed to sunlight, black UV resistant tubing should be installed. Check tubing frequently for cracks and replace as necessary.

Vinyl Tubing



Your carton may contain a roll of clear vinyl tubing; this is only for connection to the return line of the FASTPRIME™ Head and must not be used as discharge tubing.

Fittings and Machine Threads



All fittings should be hand-tightened. An additional 1/8 - 1/4 turn after the fitting is snug may be necessary to provide a leak-proof seal. Excessive overtightening or use of a pipe wrench can cause damage to the fittings, seals, or pump head.

Most LMI® pumps have straight screw machine threads on the head and fittings and are sealed by the O-rings. DO NOT use PTFE tape or pipe dope to seal threads. PTFE Tape may only be used on the 1/2" NPT thread side of the Injection Check Valve, the stainless steel liquid end connections, except for the head's discharge port, or if piping is directly connected to the pipe threads of the suction or discharge fittings.

Plumbing



Always adhere to your local plumbing codes and requirements. Be sure installation does not constitute a cross connection. Check local plumbing codes for guidelines. LMI® is not responsible for improper installations.

Back Pressure / Anti-Syphon Valve



If you are pumping downhill or into low or no system pressure, a back pressure/anti-syphon device such as LMI®'s Four Function Valve should be installed to prevent over pumping or syphoning. Contact your LMI® distributor for further information.

Electrical Connections



To reduce the risk of electrical shock, the metering pump must be plugged into a properly grounded grounding-type receptacle with ratings conforming to the data on the pump control panel. The pump must be connected to a good ground. DO NOT USE ADAPTERS! All wiring must conform to local electrical codes. If the supply cord is damaged, it must be replaced by the manufacturer, stocking distributor, or authorized repair center in order to avoid a hazard.

Fuse (all models) and Battery (AD9 only)



Caution, Battery may explode if mistreated. Do not recharge, disassemble or dispose of in fire. The battery and fuse are internal, factory serviceable parts, and must be replaced by the factory or a qualified distributor with parts of the same type and rating.

Flooding



Install this pump in a location where flooding cannot occur.

Ground Fault Circuit Interrupter



To reduce the risk of electric shock, install only on a circuit protected by a Ground Fault Circuit Interrupter (GFCI).

Line Depressurization

To reduce the risk of chemical splash during disassembly or maintenance, all installations should be equipped with line depressurization capability. Using LMI®'s Four-Function Valve (4 FV) is one way to include this feature.

Over Pressure Protection

To ensure safe operation of the pump it is recommended that some type of safety/pressure relief valve be installed to protect the piping and other system components from failing due to excessive pressure.

Chemical Concentration

There is a potential for elevated chemical concentration during periods of no flow, for example, during backwash in the system. Steps, such as turning the pump off, should be taken during operation or installation to prevent this. See your distributor about other external control options to help mitigate this risk.

Retightening Components

Plastic materials will typically exhibit creep characteristics when under pressure over a period of time and to insure a proper fit it may be necessary to retighten the head bolts periodically. To insure proper operation, we recommend tightening the bolts to 25 inch-pounds after the first week of operation and on a monthly basis thereafter.

Flow Display

The default flow value as shown on the pump display is accurate at maximum pressure and 100% stroke length. If your operating conditions differ from this, then calibration is necessary in order to display an accurate measure of the flow.



TABLE OF CONTENTS - Manual

SECTION 1 - INTRODUCTION	1
1.1 SPECIFICATIONS	1
1.2 UNPACKING CHECK LIST	2
SECTION 2 - INSTALLATION	3
2.1 PUMP LOCATION AND INSTALLATION	3
2.2 PUMP MOUNTING	3
2.2.1 Flooded Suction	3
2.2.2 Suction Lift - Wall Bracket Mount	3
2.2.3 Suction Lift - Tank Mount	3
2.2.4 Suction Lift - Shelf Mount	3
2.3 TUBING CONNECTIONS	5
2.4 FOUR-FUNCTION VALVES (4-FV)	6
2.5 FOUR-FUNCTION VALVES INSTALLATION	7
2.6 FAST PRIME™	8
2.7 AUTO PRIME™	8
2.8 FOOT VALVE / SUCTION TUBING INSTALLATION	9
2.9 INJECTION CHECK VALVE AND DISCHARGE TUBING INSTALLATION	10
SECTION 3 - OPERATION	11
3.1 OUTPUT ADJUSTMENT CONTROLS	11
3.2 START-UP AND ADJUSTMENT	14
3.2.1 Start-Up/Priming for FASTPRIME™ Heads (LE-XXXNX)	14
3.2.2 Start-Up/Priming for Pump Supplied with 4-FV (LE-XXXSX or LE-XXXHX)	14
3.2.3 Start-Up/Priming for AUTOPRIME™ Heads (LE-XXXAX or LE-XXXHX)	15
3.3 OUTPUT ADJUSTMENT	15
3.3.1 Total Pump Output	15
3.3.2 Calibrating the Displayed Flow (AD2, AD8)	15
3.4 METHODS OF EXTERNALLY TRIGGERING OR PACING AD8 AND AD9 PUMPS	17
3.4.1 Control Modes	19
3.4.1.1 Local/Internal Mode	19
3.4.1.2 Changing Displayed Flow Units (AD2, AD8)	19
3.4.1.3 Remote Mode (for AD8)	19
3.4.1.3.1 Divide Mode (for AD8)	19
3.4.1.3.2 Multiply Mode (for AD8)	19
3.4.1.3.3 Analog Mode (for AD8)	20

SECTION 4 - SPARE PARTS REPLACEMENT AND ROUTINE MAINTENANCE	21
4.1 DEPRESSURIZING THE DISCHARGE LINE (FOR PUMPS EQUIPPED WITH A 4-FV ONLY).....	21
4.2 DEPRESSURIZING THE DISCHARGE LINE (FOR SINGLE BALL FASTPRIME™ HEADS ONLY)	21
4.3 LIQUIFRAM™ (DIAPHRAGM) REPLACEMENT	22
4.4 START-UP / PRIMING FOR AUTOPRIME™ HEADS	23
4.5 INJECTION CHECK VALVE PARTS REPLACEMENT	24
4.6 FASTPRIME™ VALVE O-RING REPLACEMENT	25
4.7 DRIVE PARTS LIST.....	27
4.8 EPU Wiring Diagram	28
4.9 LIQUID END PARTS	29
SECTION 5 - WIRING DIAGRAMS	32
SECTION 6- TROUBLESHOOTING	39



TABLE OF CONTENTS - Programming Guide

1.0 INTRODUCTION	42
2.0 FEATURES	43
3.0 KEYPAD/DISPLAY: DESCRIPTION AND FUNCTION	44
3.1 POWER BUTTON	44
3.2 MODE SELECTION BUTTON	44
3.3 UP AND DOWN BUTTONS	44
3.4 GRAPHICAL DISPLAY	45
3.5 STROKE ADJUSTMENT KNOB	45
3.6 PUMP ON / OFF LED	45
3.7 LOW LEVEL INDICATOR LED	45
4.0 OPERATION OF THE SERIES AD9	46
4.1 PUMP START / STOP	46
4.2 PUMP SPEED	46
4.3 PRIMING THE PUMP	46
4.4 LOCKING / UNLOCKING THE PUMP	47
4.5 ALARM/ICON AREA	48
5.0 CONTROL MODE SELECTION MENU	49
5.1 MANUAL MODE (INTERNAL)	50
5.2 PULSE MULTIPLY MODE (EXTERNAL)	51
5.3 PULSE DIVIDE MODE (EXTERNAL)	52
5.4 ANALOG MODE (EXTERNAL)	53
5.4.1 Programming the Analog Mode Response Curve	54
5.5 TIMED EVENT MODE (INTERNAL)	55
5.5.1 Programming Timed Events	56
6.0 ADVANCED CONFIGURATION MENU	57
6.1 SET UNITS	57
6.2 SET BATCH MODE	58
6.3 SET PULSE WIDTH	58
6.4 SET LOCK MODE CONFIGURATION	58
6.5 SET CLOCK	59
6.6 PUMP CALIBRATION	60
6.6.1 Single-Point Calibration Procedure	61
6.6.2 Two-Point Calibration Procedure	62
6.7 CONFIGURE ALARM OUTPUT	64
6.7.1 Configure Alarm Output Mask	64
6.8 SET REMOTE INTERNAL-EXTERNAL MODE INPUT	65
6.9 DIGI-PULSE™ FLOW MONITORING SETUP	66
6.10 SET PERCENT-OF-TIME OPERATION	67
6.11 LOAD FACTORY DEFAULTS	68
6.12 VIEW PUMP INFORMATION	68

LIST OF ILLUSTRATIONS

FIGURE 1. ROYTRONIC EXCEL™ Series AD9 Control Panel.	44
FIGURE 2. Single-Point Calibration	60
FIGURE 3. Two-Point Calibration	60

SECTION 1 - INTRODUCTION

LMI® is the world's most versatile manufacturer of economical and efficient metering pumps. This manual addresses the installation, maintenance and troubleshooting procedures for manually and externally controlled pumps. LMI® has a worldwide network of stocking representatives and authorized repair centers to give you prompt and efficient service.

Note:

Please review this manual carefully. Pay particular attention to warnings and precautions. Always follow good safety procedures, including the use of proper clothing, eye and face protection.

1.1 SPECIFICATIONS

	AD2XY (where X is any number; where Y is 1, or 8)	AD2XY (where X is any number; where Y is 2,3,4,5,6,7, or 9)	AD8XY, or AD9XY (where X is any number; where Y is any number)
Operating Temperature	14 to 113°F -10 to 45°C	14 to 113°F -10 to 45°C	14 to 113°F -10 to 45°C
Voltage	110 to 120 V	220 to 240 V	95 to 240 V
Frequency	50 to 60 Hz	50 to 60 Hz	50 to 60 Hz
Max. Current	2.0 A	1.0 A	1.4 A
Wattage	25 W	22 W	20 W

Table 1

	AD2	AD8	AD9
Battery	N/A	N/A	Panasonic BR1225 or Renata CR1225 or Energizer/Eveready CR1220
Fuse	Bel Fuse 5HT1.25-R Time-lag, 5mm x 20mm	Bel Fuse 5HT 2-R Time-lag, 5mm x 20mm	Bel Fuse 5H 2-R Time-lag, 5mm x 20mm

Table 2

Note:

The battery and fuse are internal, factory serviceable parts, and must be replaced by the factory or a qualified distributor with parts of the same type and rating.

1.2 UNPACKING CHECK LIST

Your carton will contain many or all of the following items. Please notify the carrier immediately if there are any signs of damage to the pump or its parts.

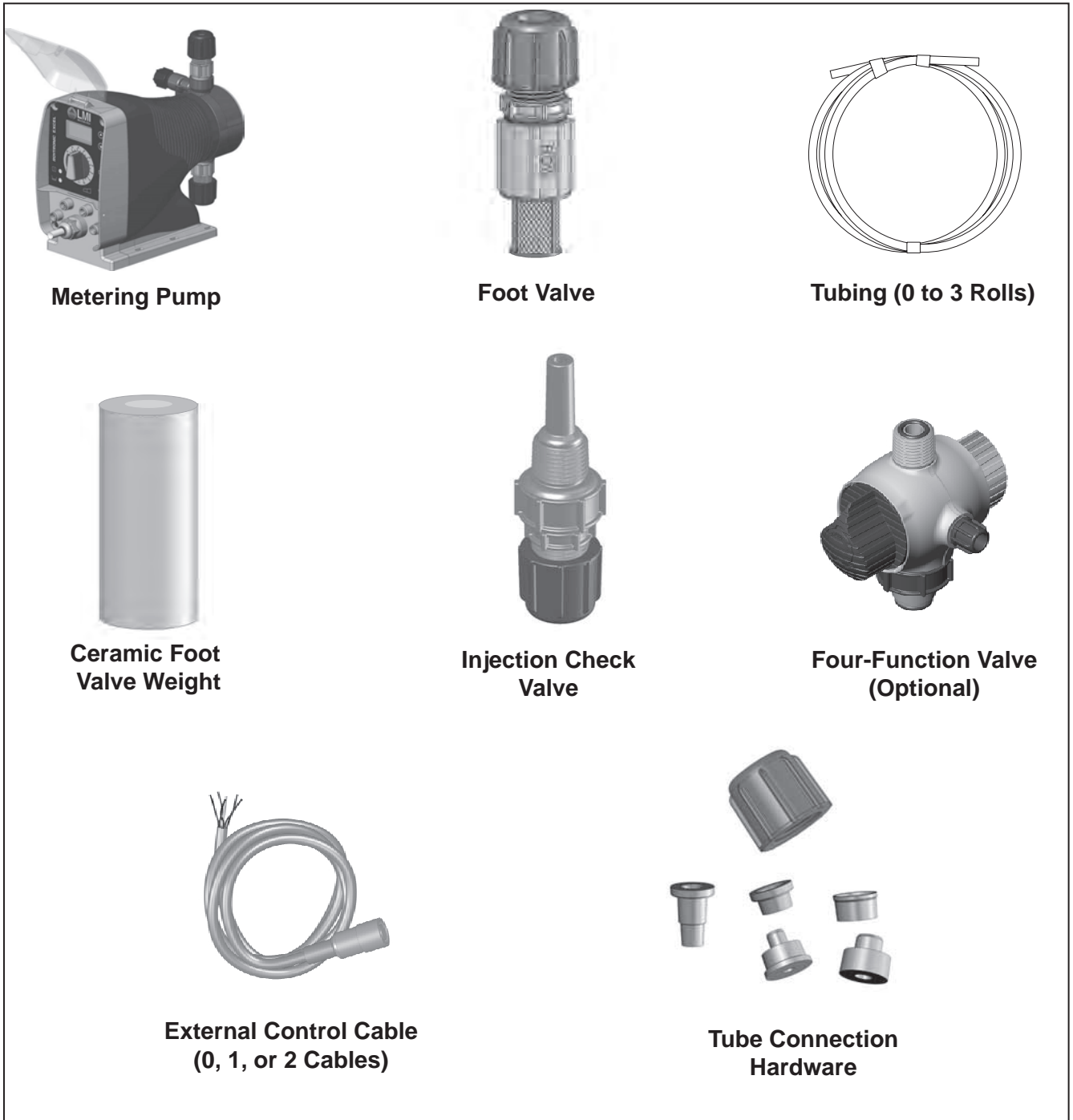

Figure 1. Unpacking Check Sheet

SECTION 2 - INSTALLATION

2.1 PUMP LOCATION AND INSTALLATION

Locate pump in an area convenient to solution tank and electrical supply.

The pump should be accessible for routine maintenance, and should not be operated in ambient temperatures above 113°F (45°C). If the pump will be exposed to direct sunlight, LMI® black, UV resistant tubing should be installed.

This pump is cord connected and not intended for permanent mounting to a building. However, temporary mounting to stabilize the pump during operation may be necessary as long as tools are not required for the installation or removal of the pump.

2.2 PUMP MOUNTING

The pump can be mounted in one of two ways:

- A. **FLOODED SUCTION** (ideal installation); or
- B. **SUCTION LIFT** - when suction lift is less than 5 feet (1.5 m) for solutions having a specific gravity of water or viscosity of less than 100 cSt (centistokes). For denser or more viscous solutions, consult distributor.

Note that suction conditions can affect the performance of the pump. This effect is more pronounced with lower pressure pumps. Consult your distributor for additional information.

Your LMI® metering pump must be mounted so that the suction and discharge valves are vertical. **NEVER position pump head and fittings horizontally.**

2.2.1 Flooded Suction

For flooded suction the pump is mounted at the base of the storage tank. This installation is the most trouble-free, and is recommended for very low outputs, solutions that gasify, and high-viscosity solutions. Since the suction tubing is filled with solution, priming is accomplished quickly and the chance of losing prime is reduced. A foot valve is not necessary in a flooded suction installation.

When pumping downhill or into low or no pressure system, a back pressure/anti-syphon device should be installed to prevent overpumping or syphoning. Although popular for all solutions, LMI® recommends flooded suction installations for all high-viscosity fluid applications.

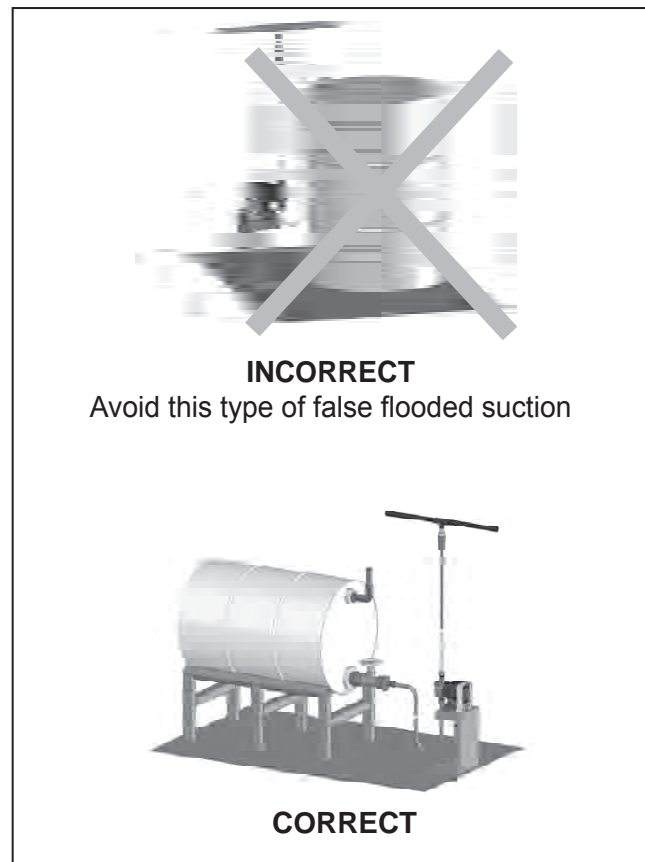

Figure 2. Flooded Suction Pump Mounting

2.2.2 Suction Lift - Wall Bracket Mount

The pump may be mounted using an LMI® Wall Mount Bracket Assembly (part no. 34643) directly above the solution tank. A pump mounted in this manner allows for easy changing of solution tanks or drums.

2.2.3 Suction Lift - Tank Mount

The pump may be mounted on a LMI® 10-gallon tank (part no. 27421), 35-gallon tank (part no. 27400), and 50-gallon tank (part no. 26350).

2.2.4 Suction Lift - Shelf Mount

The pump may be mounted on a shelf (customer supplied) maintaining a suction lift of less than 5 ft (1.5 m).

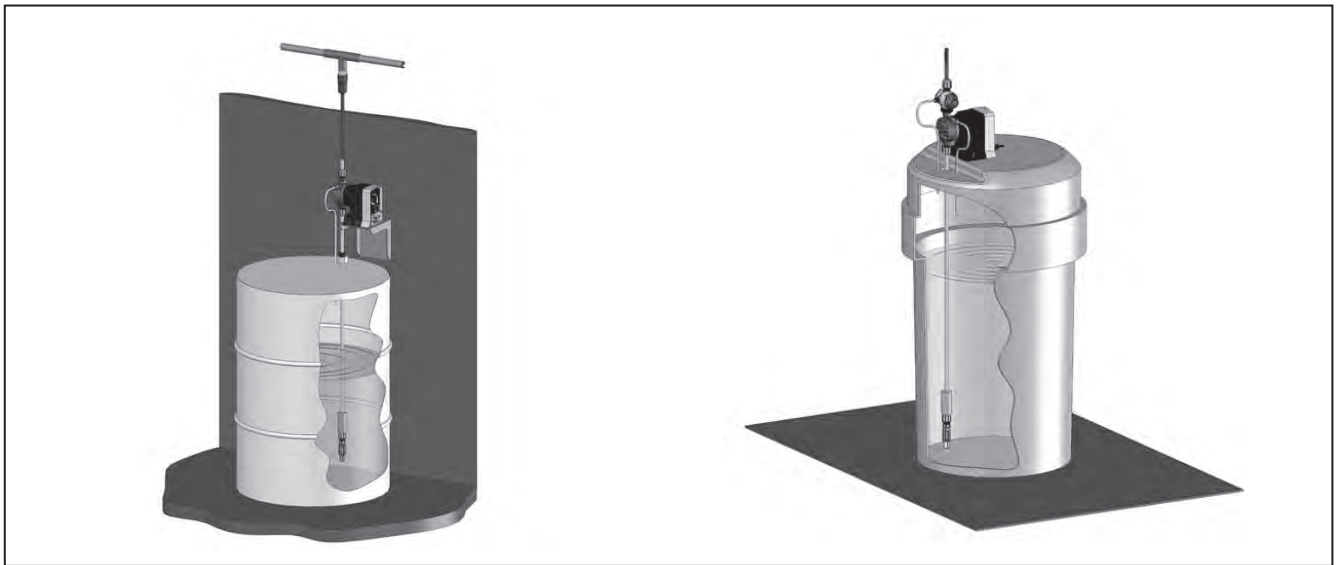

Figure 3

SECTION 2 - INSTALLATION

2.3 TUBING CONNECTIONS

1. Insert tubing through Coupling Nut. Tubing should enter the smaller end of the Coupling Nut first, orienting the larger opening of the Coupling Nut toward the tubing end.
- 2a. For 1/4" OD tubing: Position the Female Ferrule so that 1/4" to 3/8" (5-10 mm) of tubing protrudes from the Female Ferrule. Orient the raised collar of the Ferrule toward the Coupling Nut (reference *Figure 4*).
- 2b. For 3/8" or 1/2" OD tubing: Position a Female Ferrule about 1 inch (25 mm) from end of tubing. Orient the raised collar of the Female Ferrule toward the Coupling Nut. Then, insert the Male Ferrule onto the end of the tube, pushing the tube into the bottom of the groove in the Male Ferrule. Then slide the Female Ferrule down the tubing and with your fingers, press tightly into the Male Ferrule (reference *Figure 5*).
3. Firmly hand tighten the Coupling Nut onto the fitting.

Note:

Tightening with pliers may cause the Ferrules to break.

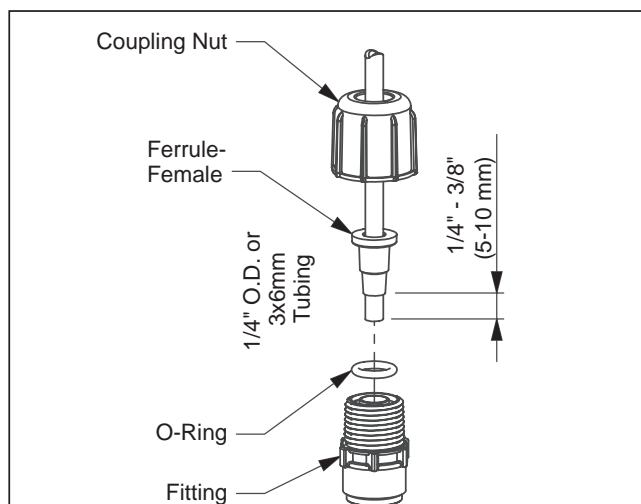

Figure 4

⚠ CAUTION

A. USE ONLY LMI® TUBING. ALWAYS USE LMI® SUPPLIED TUBING WITH YOUR PUMP, AS THE TUBING IS SPECIFICALLY DESIGNED FOR USE WITH THE PUMP FITTINGS.

B. DO NOT USE CLEAR VINYL TUBING ON THE DISCHARGE SIDE OF THE PUMP. THE PRESSURE CREATED BY THE PUMP CAN RUPTURE VINYL TUBING.

C. BEFORE INSTALLATION, ALL TUBING MUST BE CUT WITH A CLEAN SQUARE END.

D. VALVE AND HEAD CONNECTIONS FROM THE FACTORY ARE CAPPED OR PLUGGED TO RETAIN PRE-PRIME WATER. REMOVE AND DISCARD THESE CAPS OR PLUGS BEFORE CONNECTING TUBING.

DO NOT USE PLIERS OR PIPE WRENCH ON COUPLING NUTS OR FITTINGS.

DO NOT REUSE FERRULES. USE ONLY NEW FERRULES.

Replacement Ferrules, and Coupling Nuts are available as the following kit numbers.

Tube Size	Kit Number
1/2" Tube	77382
3/8" Tube	77383
1/2" Tube	77384
3 x 6 mm Tube	77378
6 x 8 mm Tube	77379
9 x 12 mm Tube	77380

*One kit is needed for each end of the tube.

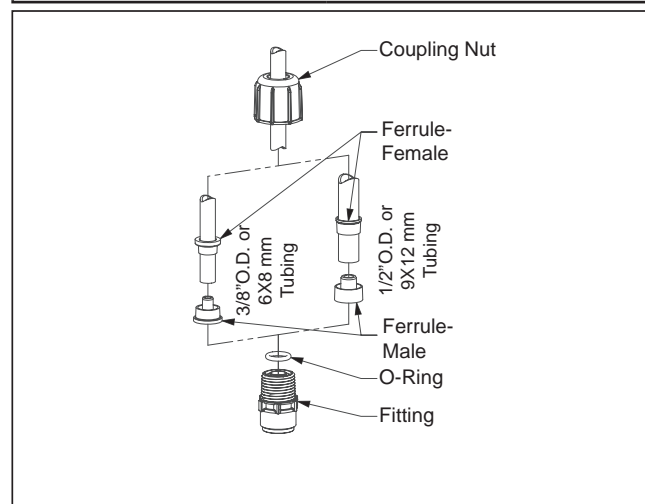

Figure 5

2.4 FOUR-FUNCTION VALVES (4-FV)

Your pump may be equipped with a 4-FV, or standard discharge valve. If your pump is not equipped with a four-function valve and you feel it is needed in your application, it can be purchased as an accessory. Contact your local LMI® stocking distributor. The features of a 4-FV are listed below.

1. **Pressure Relief:** If the discharge line is over pressurized, the valve opens sending solution back to the supply tank.
2. **Line Depressurization:** Opening the relief knob provides line drain back to the supply tank.

3. **Anti-Syphon:** Prevents syphoning when pumping solution downhill or into a vacuum.

4. **Back Pressure:** Supplies approximately 20 psi back pressure to prevent overpumping when little or no system back pressure is present.

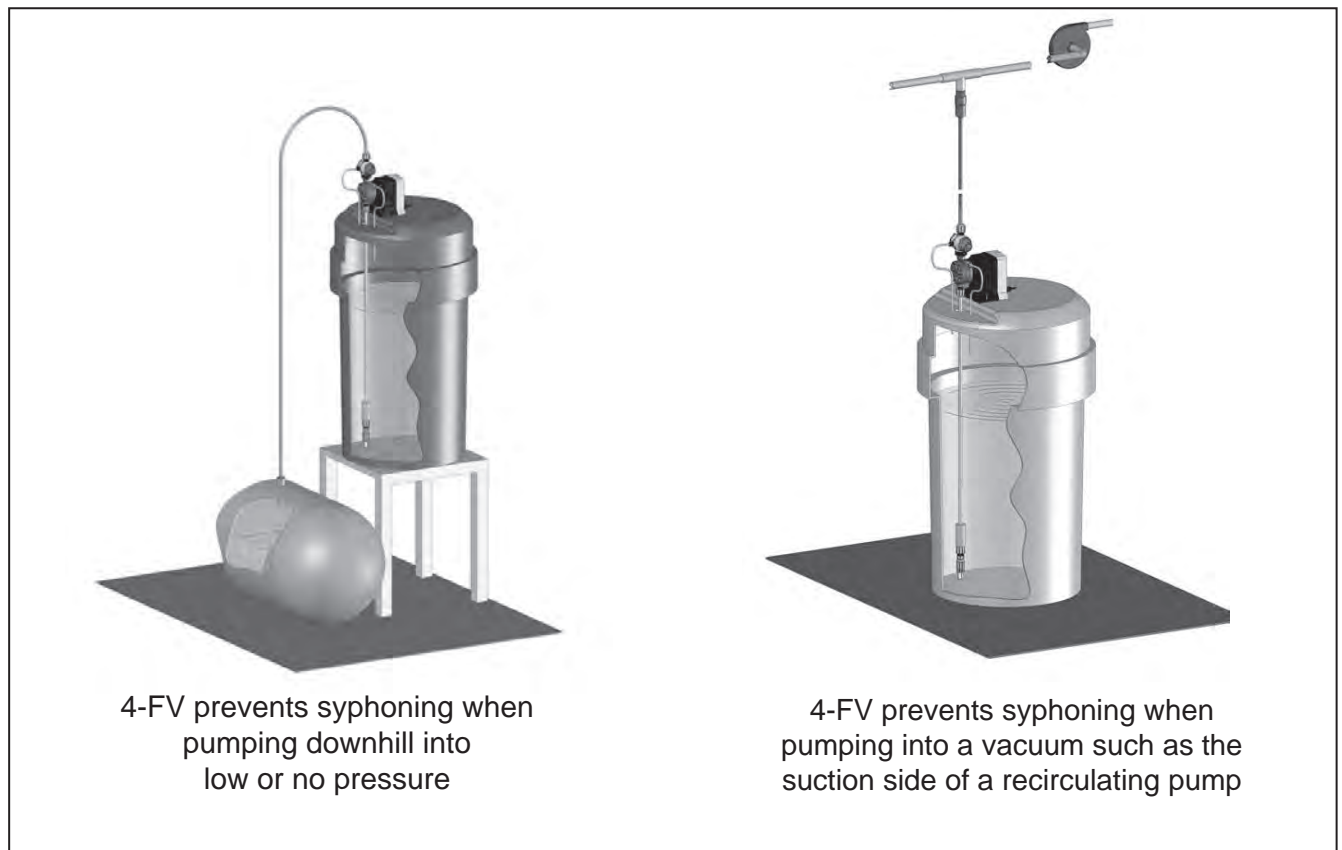

Figure 6. Typical Installations Requiring the Anti-Syphon Feature of a Four-Function Valve

SECTION 2 - INSTALLATION

2.5 FOUR-FUNCTION VALVE INSTALLATION

To install a 4-FV, the 4-FV Fitting and Coupling Nut should be assembled with the appropriate cartridges into the discharge port of the pump. Use a 13/16" or 20 mm socket to tighten fitting. Tightening to 50 inch-pounds is recommended. Do not over tighten.

To assemble the Four-Function Valve Body, insert the large opening on the Four-Function Valve Body into the 4-FV Coupling Nut and hand tighten. You can position the valve to have the Bleed Nut pressure relief port in any convenient location by tightening the 4-FV Coupling Nut with the Bleed Nut positioned 90° CCW from desired location, then holding the 4-FV Coupling Nut stationary while turning the 4-FV Body the final 90° to desired position. Next, insert the 1/4" tubing through the Bleed Nut. Ensure that about 1/4" (6 mm) of tubing is protruding through the tip of the Bleed Nut. Firmly hand tighten the Bleed Nut in the hole on the side of the 4-FV. This tubing should be routed back to the supply tank. To ensure proper function of the priming function, the end of this tubing should not be submerged in the solution.

CAUTION THIS RETURN LINE TUBING MUST BE SECURED TO ENSURE PUMPED SOLUTION WILL SAFELY RETURN TO SUPPLY.

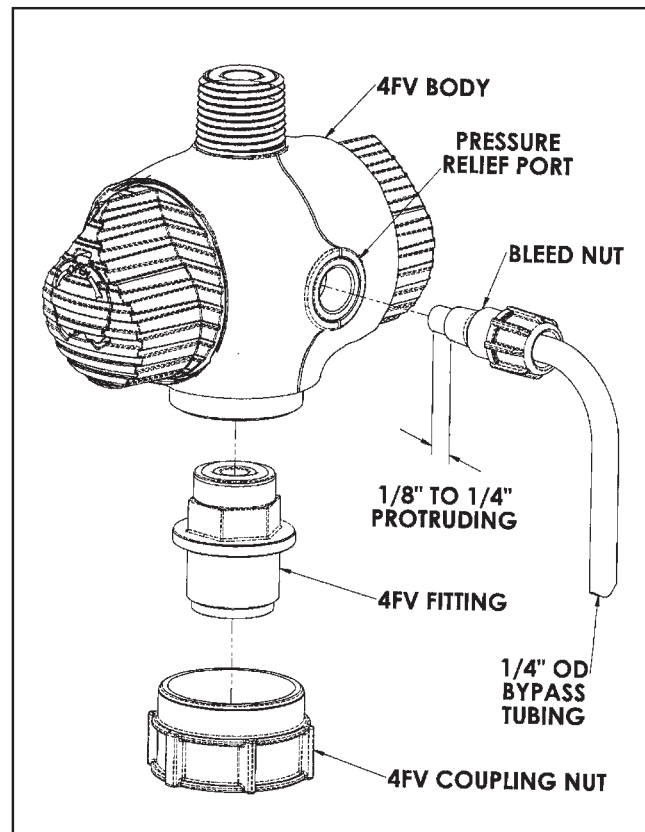

Figure 7. Four-Function Valve Tubing Connection

2.6 FASTPRIME™

The FASTPRIME™ Head is equipped with a valve that allows for opening the head to atmospheric pressure. When installing a pump equipped with a FASTPRIME™ Head connect the 3/8" outer diameter clear vinyl tubing provided with the pump to the barbed nozzle. Route the vinyl return line back to the solution tank. This tubing must not be submerged in the solution.

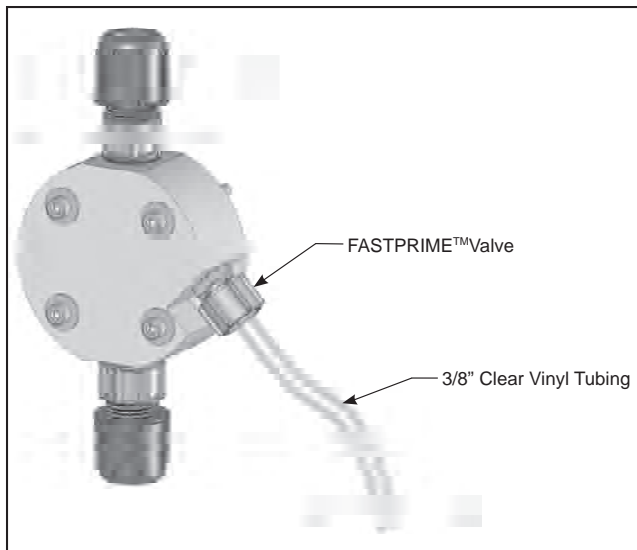

Figure 8. FASTPRIME™ Head

2.7 AUTOPRIME™

Pumps installed with the AUTOPRIME™ Liquid End are equipped with a valve that allows for constant removal of vapors and gasses inherent with effervescent chemicals such as Sodium Hypochlorite and Hydrogen Peroxide. The valve keeps the pump primed automatically. When installing a pump equipped with an AUTOPRIME™ Liquid End, connect the 1/2" OD Polyethylene tubing to the top vertical fitting, and route this line back to the supply tank. To ensure priming, this tubing should not be submerged in the solution. The horizontal fitting is the discharge, and the bottom vertical fitting is the suction.

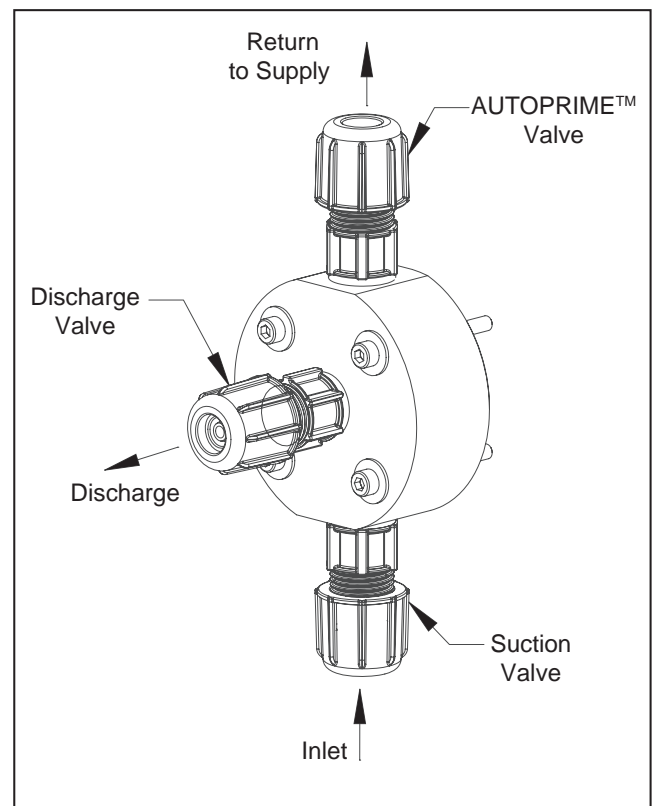

Figure 9. AUTOPRIME™ Liquid End Example

SECTION 2 - INSTALLATION

2.8 FOOT VALVE / SUCTION TUBING INSTALLATION

The Foot Valve acts as a check valve to keep the pump primed in suction lift applications.

The foot valve is designed to be submersed in the solution tank or drum and must sit in a vertical position at the bottom. Position approximately 2 inches (50 mm) off the bottom if the tank or drum contains sediment.

Note:

Pump models equipped with high-viscosity liquid ends are not equipped with foot valves. Flooded suction is recommended. A 1/2" NPT connector is included for flooded suction installations.

The ceramic weight, when installed, positions the foot valve in a vertical position.

1. Attach the foot valve to one end of the suction tubing (see Tubing Connections, Section 2.3).
2. Slide the ceramic weight over the tubing end until it contacts the top of the foot valve coupling nut.
3. Place foot valve and tubing into the solution tank. Check that the foot valve is vertical and approximately 2 inches (50 mm) from the bottom of the tank or drum (see illustration). Connect the other end of the tubing to the suction side of the pump head (bottom side) (see Tubing Connections, Section 2.3).

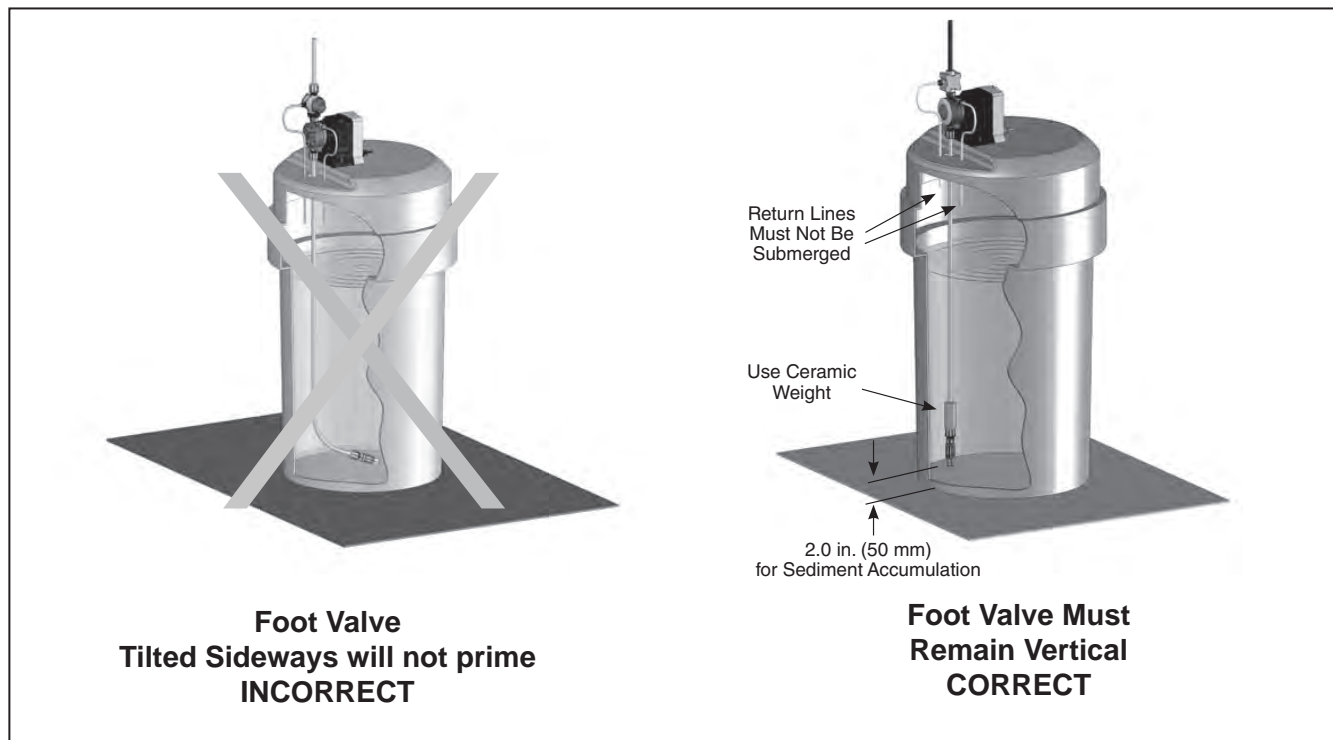

Figure 10. Foot Valve / Suction Tubing Installation

2.9 INJECTION CHECK VALVE AND DISCHARGE TUBING INSTALLATION

The Injection Check Valve prevents backflow from a treated line. Install the injection check valve at the location where chemical is being injected into the system. Any size Female NPT fitting or pipe tee with a reducing bushing to ½" Female NPT will accept the injection check valve. PTFE tape should only be used on threads that are connected with pipes.

When installing the Injection Check Valve, be sure to position it so that the valve enters the bottom of your pipe in a vertical position. Variations left and right within 80° acceptable (See illustration).

After cutting an appropriate length of tubing, connect tubing to the injection check valve then back to the discharge side of the pump head. Make sure it does not crimp or come into contact with hot or sharp surfaces (see Tubing Connections, Section 2.3).

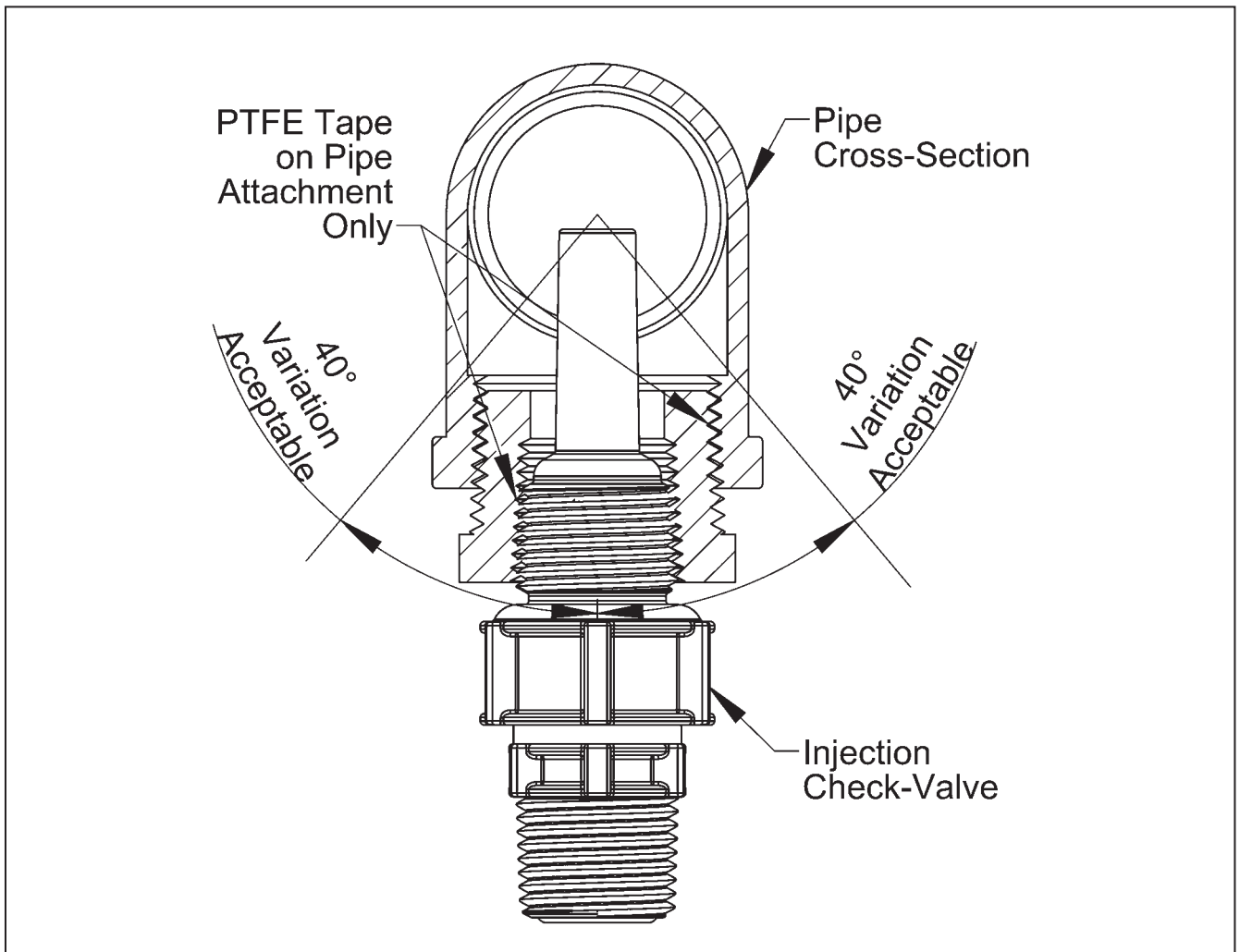

Figure 11. Typical Injection Check Valve Installation

SECTION 3 - OPERATION

3.1 OUTPUT ADJUSTMENT CONTROLS

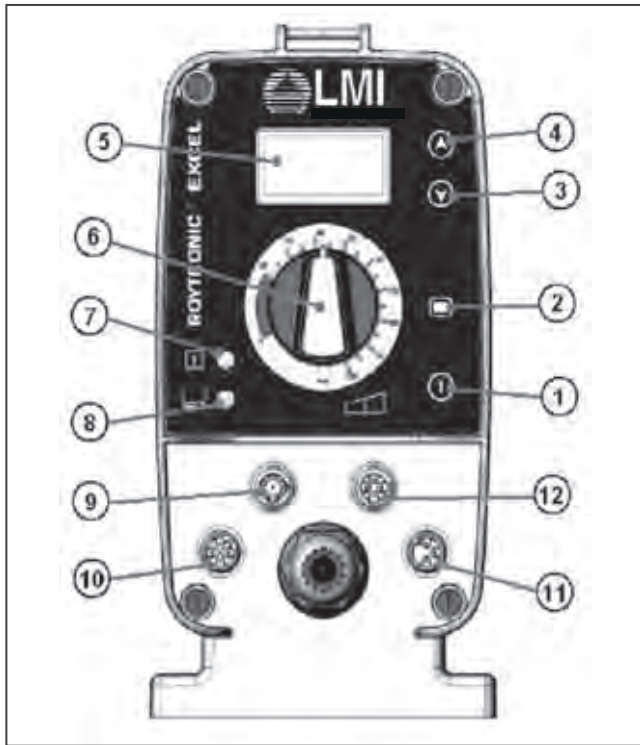
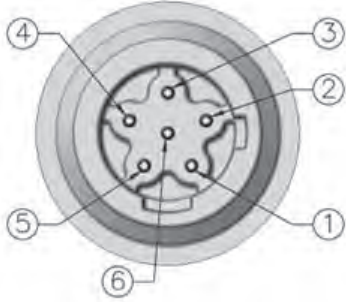

Figure 12

- 1. Power Button:** This button allows convenient starting and stopping of the pump.
- 2. Mode Selection Button:** For pumps with external control capability (AD8, AD9) this button switches pump operation between internal and external modes. When operating in internal mode the Pulse Indicator Light will flash green while pumping. When operating in external mode the Pulse Indicator Light will flash yellow while pumping.
- 3. Down Button:** This button reduces the stroke speed of the pump. It will reduce the stroke speed by 1 each time it is pressed. If this button is held down, it will rapidly reduce the stroke speed. When a speed of 1 stroke per minute (SPM) is reached the speed can be further reduced by pressing this button again to enter stroke per hour settings.
- 4. Up Button:** This button increases the stroke speed of the pump. It will increase the stroke speed by 1 each time it is pressed. If this button is held down, it will rapidly increase the stroke speed. When a speed of 59 strokes per hour (SPH) is reached the speed can be further increased by pressing this button again to enter stroke per minute settings.
- 5. LCD Display:** This display will show the stroke speed of the pump. Pumps with theoretical (AD2, AD8, AD9) or actual (AD9 when combined with a flow meter) flow will display the flow here.
- 6. Stroke Adjustment Knob:** This knob provides adjustment of the stroke length. Turning this knob clockwise increases the stroke length, which results in a higher amount of chemical displaced per stroke. It is recommended that the stroke range stay between 20% and 100%.
- 7. Pulse Indicator Light:** This light will flash green when pumping in internal mode and will flash yellow when pumping in external mode. The light is on between strokes and off during the actual stroke.
- 8. Low-Level Indicator Light:** For units with Single-Level Float Sensors this light will turn red when the Low-Level Sensor registers empty. This will turn the pump off. For units compatible with Dual-Level Sensors (AD8, AD9) the light will turn yellow when a low level is registered, and red when an empty level is registered. The pump will turn off when it registers an empty level.

9. Output, Alarm & Remote Mode Connector (6-Pin): This connector is used for the special functions associated with the AD9 controls. For the AD9 this connector is associated with the 4-20ma out, Alarm Out, and Internal/ External remote modes.



1. Alarm Out (Red/White) - Programmed as either an Alarm Output or Internal/External mode indicator. As an Alarm Output, pins 1 and 2 will give a closure (solid state) triggered by: empty tank indication, input pulse error, exceed batch error, or flow switch activation. For remote mode indication it is open for internal mode and closed for external.
2. Alarm Return (Red) - Return side for the above pin 1 Alarm Out.
3. Remote Internal/External Mode (AD9) (Green) - This pin is programmed as Internal/ External remote mode control for an AD9. If programmed as the Internal/External control, a closure will put the AD9 into external mode.

4. Pulse Out (AD9) (Red/Yellow) - On the AD9 this pin gives a 100ms pulse output for each pump stroke.
5. 4-20mA Out (AD9) (Red/Black) - On the AD9 this pin is the positive 4-20ma output. This output will show you 4ma when the pump is idle, 20ma at max stroke speed.
6. Ground/Return Connection (Red / Blue) - Common Ground

10. External Control Connector (5-Pin):

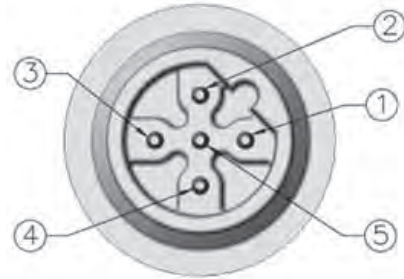

This connector is for the connection of various options and accessories that can be used to externally control the pump. The pin functions (and the wire color for the standard LMI® external control cable) are as follows:

1. Remote On/Off Signal (Brown)
2. Ground/Return Connection (White)
3. External Pulse Signal (Blue)
4. 24V 75 mA* Power Supply (Black)
5. 4-20mA Input Signal (Green/Yellow)

SECTION 3 - OPERATION

11. Low-Level Connector (3-Pin):

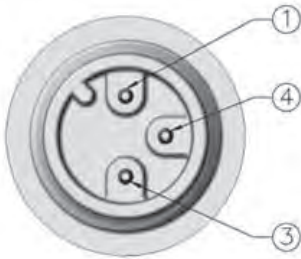

This connector is for the connection of a Low-Level Sensor (49246) or a Dual-Level Sensor (49249). The Tank Empty input connections are always active for all models in all functional modes. The Tank Low input connections are always active for models equipped with dual level functionality (AD8, AD9). If the fluid level drops below the top float on a Dual-Level Sensor, the Low-Level Indicator Light will turn yellow. If the fluid level drops below the float on a Low-Level Sensor, or the bottom float on a Dual-Level Sensor, the Low-Level Indicator Light will turn red, and the pump will stop. The pump is designed to recognize an open circuit as full and a closed circuit as low or empty. There is a five second delay between triggering the sensor, and the pump's reaction. This is intended to avoid triggering during refilling your supply tank. The pin functions are as follows:

1. Tank Empty Signal
3. Tank Low Signal
4. Ground/Return Connection

12. Flow Monitor / Meter Connector (4-Pin):

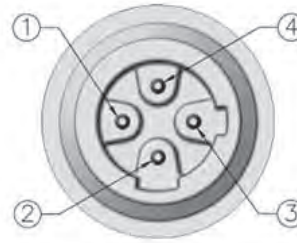

This connector will be used with a Milton Roy flow meter or the Milton Roy DIGI-PULSE™ flow monitor (FM-ROY-9). The pin functions are as follows:

1. Flow Meter In – A closure between this pin and ground registers a pulse for the flow meter/monitor.
2. 24 Volt 75 mA* Supply – Supply voltage for a Milton Roy flow meter.
3. Ground/Return Connection – Common ground
4. Flow Meter Sense – The condition of this pin will set the pump into the Digipulse or Flow Meter mode. This will automatically occur when the Milton Roy device is connected. A connection to ground indicates the use of a flow meter, while an open circuit indicates a flow monitor.

Note:

The total current output of the 5-pin and 4-pin connectors should not exceed 75 mA.

3.2 START-UP AND ADJUSTMENT

1. The pump is normally self-priming if suction lift is 5 ft (1.5m) or less and the steps below are followed.
2. Pumps are shipped from the factory with water in the pump head to aid in priming.

3.2.1 Start-Up/Priming for FASTPRIME™ Heads (LE-XXXNX)

▲ CAUTION READ THIS ENTIRE SECTION COMPLETELY BEFORE PROCEEDING.

When all precautionary steps have been taken, the pump is mounted, and the tubing is securely attached, you may now start priming the pump.

1. Plug in or switch the pump on.
2. While the pump is running, set the Speed Adjustment Knob and the Stroke Adjustment Knob at 100%.
3. Turn The FASTPRIME™ knob 1 to 2 turns counter-clockwise ↺.
4. The suction tubing should begin to fill with solution from the tank.
5. A small amount of solution will begin to discharge out the return line of the FASTPRIME™ valve. Once this happens, turn the knob clockwise ↻ until hand tight and **SHUT THE PUMP OFF**.
6. The pump is now primed.
7. Proceed to output adjustment, Section 3.3.

Note:

If the pump does not self-prime, remove the fitting on the discharge side of the pump head. Remove the check valve and pour water or solution into the port until the head is filled. Replace valve, then follow start up/priming steps.

3.2.2 Start-Up/Priming for Pump Supplied with 4-FV (LE-XXXSX or LE-XXXHX)

▲ CAUTION READ THIS ENTIRE SECTION COMPLETELY BEFORE PROCEEDING.

When all precautionary steps have been taken, the pump is mounted, and the tubing is securely attached, you may now start priming the pump.

1. Plug in or switch the pump on.
2. While the pump is running, set the Speed Adjustment Knob and the Stroke Adjustment Knob at 100%.
3. Open the relief side (black knob) of the 4-FV by turning to the stop (about 1/8 turn).
4. The suction tubing should begin to fill with solution from the tank.
5. A small amount of solution will begin to discharge out the return line of the 4-FV. Once this happens, return the knob to the 12:00 position and **SHUT THE PUMP OFF**.
6. The pump is now primed.
7. Proceed to output adjustment, Section 3.3.

Note:

If the pump does not self-prime, remove the 4-FV on the discharge side of the pump head. Remove the check valve and pour water or solution into the port until the head is filled. Replace valve, then follow start up / priming steps.

SECTION 3 - OPERATION

3.2.3 Start-Up/Priming for AUTOPRIME™ Heads (LE-XXXAX or LE-XXXHX)

⚠ CAUTION READ THIS ENTIRE SECTION COMPLETELY BEFORE PROCEEDING.

When all precautionary steps have been taken, the pump is mounted, and the tubing is securely attached, you may prime the pump.

1. Plug in or switch on the pump.
2. While the pump is running, set the speed knob and the stroke knob at 100%.
3. The suction tubing should begin to fill with solution from the tank as the AUTOPRIME™ valve purges air from the pump head.
4. Once the solution begins to exit the pump head through both the discharge valve and the AUTOPRIME™ valve, **SHUT THE PUMP OFF**.
5. The pump is now primed.
6. Proceed to output adjustment, Section 3.3.

3.3 OUTPUT ADJUSTMENT

Once the pump has been primed, an appropriate output adjustment **MUST** be made. Pump output should be calculated and adjustments made accordingly.

3.3.1 Total Pump Output

Calculate the approximate output of the pump as follows:

PUMP OUTPUT :
MAX PUMP OUTPUT X % SPEED X % STROKE
Example: AD251-938SI

Use Max Output (from dataplate on side of pump) = 1 GPH (1 gallon per hour).

If the pump is set at 60 strokes per minute (out of a possible 120 SPM) and 70% stroke length, the approximate pump output is:

$$1.0 \times 60/120 \times 0.70 = 0.35 \text{ GPH.}$$

Multiply by 24 (hours in one day) to calculate in gallons per day.

Note:

When converting between different units, remember these conversion factors:

$$1 \text{ Gallon} = 3.785 \text{ Liters}$$

$$1 \text{ Day} = 1,440 \text{ Minutes}$$

$$120 \text{ SPM} = 7,200 \text{ SPH}$$

⚠ CAUTION IT IS IMPORTANT TO NOTE THAT THIS IS ONLY AN APPROXIMATE OUTPUT AND IT DOES NOT ACCOUNT FOR TOLERANCE VARIATIONS IN PUMP COMPONENTS OR FLOW VARIATIONS DUE TO PRESSURE SENSITIVITY, OR VISCOSITY EFFECTS. VARIATIONS DUE TO THESE EFFECTS CAN BE SIGNIFICANT, NECESSITATING CALIBRATION FOR YOUR PUMP.

3.3.2 Calibrating the Displayed Flow (AD2, AD8)

The Roytronic Excel Pumps are equipped to display a theoretical flow rate based upon the pump's stroke speed and stroke length. These calculations are based upon factory test conditions which may be significantly different from your application. It is necessary for the user to perform the following calibration procedure when the pump is connected to your system, and using the actual chemical. This one-point calibration procedure will greatly improve the accuracy of the pump's calculated flow. The closer the pump's stroke length is to the typical use stroke length, the more accurate the result. We recommend using the approximate settings determined in section 3.3.1 as a starting point for calibration.

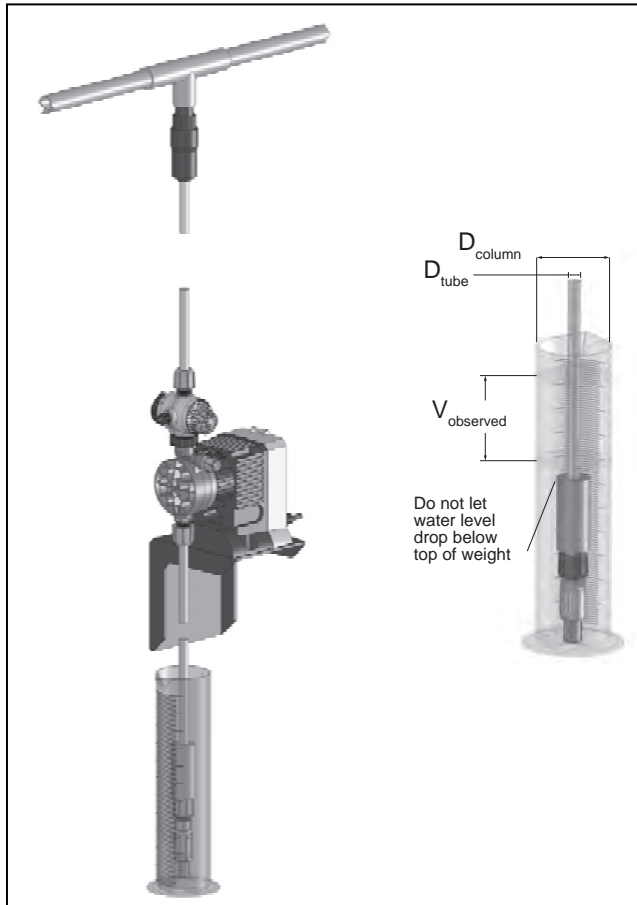

Figure 13

1. Prepare a flow measuring device such as a graduated cylinder or a scale sensitive to a gram.
2. Ensure the pump is primed following the procedures in 3.2.
3. Put the pump into Internal Mode and use the Power Button Ⓢ to turn the pump off.
4. Hold the Up Button Ⓢ and Down Button Ⓢ in at the same time for 8 seconds until 'CAL' is displayed on the LCD Display, then release the buttons. Note 'FLO' will be displayed first. Continue to press the buttons until 'CAL' is displayed.
5. Push the Power Button Ⓢ and release until a "0" is displayed.
6. Note the reading on the calibration device. If using a graduated cylinder note the starting liquid level. If using a scale note the displayed weight, or reset the scale's display to zero.
7. Push the Power Button Ⓢ and release to start the pump. Notice that the display will count the total number of strokes. (The screen will show SPH).
8. Allow the pump to run; the accuracy will improve with more strokes. Use the Power Button Ⓢ to stop the pump. The number of strokes will be displayed up to 999 strokes. If you will be pacing the pump externally, note the number of strokes.
9. Press and release the Power Button Ⓢ again. This will display the pump's estimated volume pumped in mL. (The screen will show ml/h).

10. Use the Up \uparrow and Down \downarrow Buttons to match the displayed volume to the measured volume. If using a graduated cylinder, the presence of the tubing will cause the measurement to be slightly higher than actual. The measurement should be adjusted using the formulas shown below. If using a scale, the number of grams can be divided by the specific gravity of your chemical to determine the number of mL pumped. If the pump will be controlled externally, the output volume per stroke can be determined by dividing the measured output by the number of strokes.
11. Once the displayed value has been adjusted, hold and release the Power Button Ⓞ to return the pump to internal mode.

$$V_{\text{Actual}} = V_{\text{Observed}} * R$$

where $R = 1 - (D_{\text{Tubes}} / D_{\text{Column}})^2$

For accuracy, it is important that the water level does not drop below the top of the ceramic foot valve weight.

Note:

If you will be using the pump at a different stroke length, or pressure, the pump should be recalibrated under those conditions using the procedure above to ensure accuracy.

3.4 METHODS OF EXTERNALLY TRIGGERING OR PACING AD8 AND AD9 PUMPS

Method of Triggering AD8 and AD9 Pumps through External Control Connector.

Switch or transistors must be capable of switching 24V DC at 15 milliamperes. Minimum time in low impedance state (ON) is 25 milliseconds. Minimum time in high impedance state (OFF) is 50 milliseconds.

The remote on/off input (using pins 1 and 2) is active in all modes. In the out-of-box configuration, the pump will run when contacts are open. The pump is monitoring these pins for a change in closure condition. Regardless of the pump being on or off, when the contacts close, then the pump will turn on. When the contacts open, the pump will turn off.

The Power Button overrides the remote on/off and can still be used to turn the pump on and off. If the contacts are closed when the on/off button is pressed, the pump will turn off. To restart the pump remotely, the contacts must be opened and then closed again.

These pumps have two operating modes: Local (Pulse Indicator Light flashes green) and Remote (Pulse Indicator Light flashes yellow). Pressing the Mode Selection Button switches between Local and Remote modes. The default configuration for operating mode is Local mode.

SECTION 3 - OPERATION

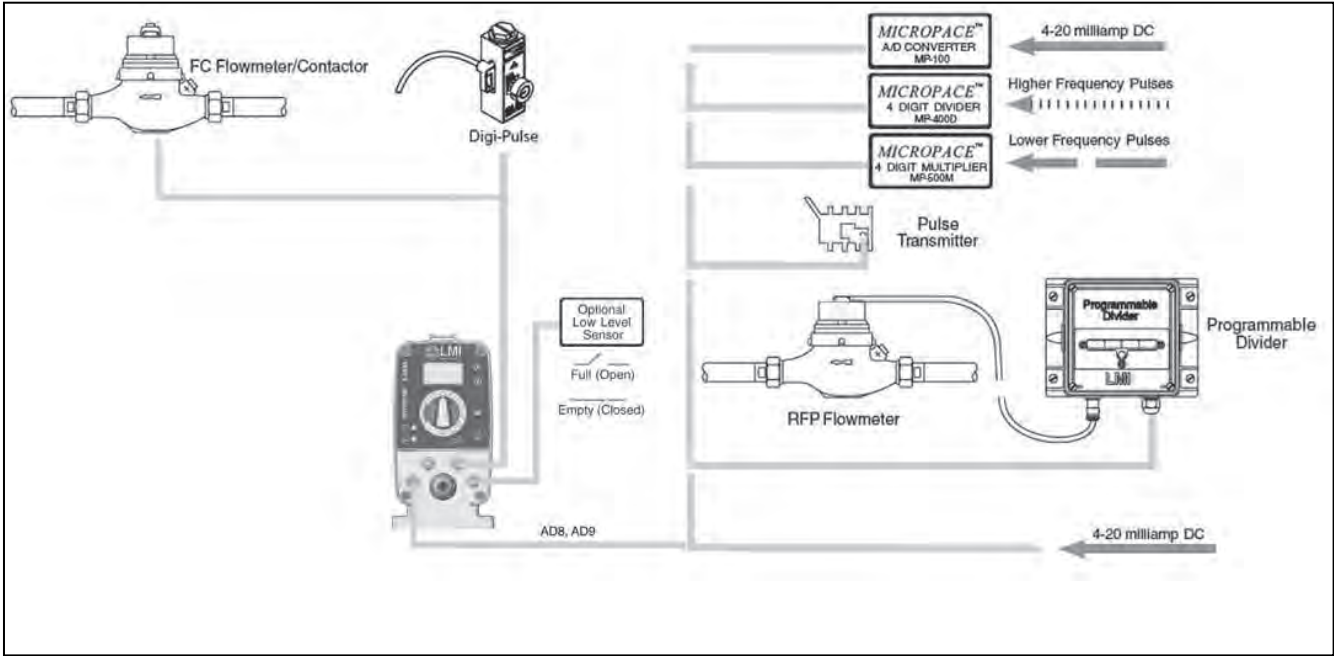
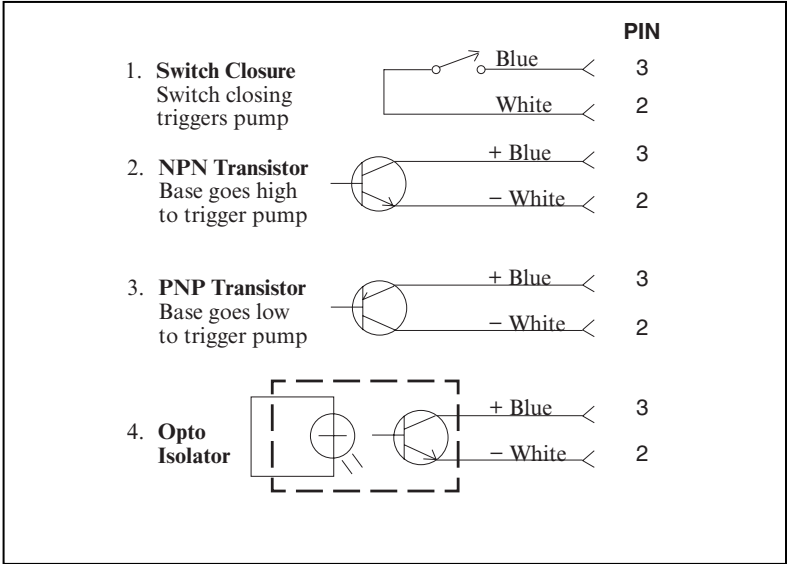

Figure 14. Methods of Externally Triggering or Pacing AD8 and AD9 Pumps



3.4.1 Control Modes

3.4.1.1 Local/Internal Mode

1. When in local mode Roytronic Excel pumps run at the speed indicated on the LCD Display.
2. The stroking speed can be adjusted from the maximum speed of 120 strokes per minute (SPM) down to 1 stroke per hour (SPH).

3.4.1.2 Changing Displayed Flow Units (AD2, AD8)

1. When in Internal Mode use the Power Button to turn the pump off.
2. Hold the Up Button and Down Button in at the same time until 'FLO' is displayed on the LCD Display, then release the buttons.
3. Use the Up or Down Buttons to select the desired units of measure.
4. Press the Power Button and the pump will return to internal mode with the desired units displayed.

3.4.1.3 Remote Mode (for AD8)

In Remote mode the pump can be controlled in a variety of ways: pulse divide, pulse multiply, or analog milliamp input. To cycle through the available modes, start in external mode, then press and hold the Power Button and Mode Selection Button simultaneously for about five seconds.

3.4.1.3.1 Divide Mode (for AD8)

The pump is in Divide Mode when a division symbol (\div) is shown on the left-hand side of the LCD Display. Use the Up Button and Down Button to select the number of incoming pulses received before a stroke occurs. Once the Power Button is pushed to turn the pump on, the LCD Display will show the approximate stroke rate of the pump based on the incoming pulses.

If it is necessary to change the pulse duration required to recognize a pulse from the factory default of 60 ms, hold both the Up Button and Down Button until a number appears followed by the letter 'm'. This number is the minimum required time in milliseconds needed to count as a pulse. Use the Up Button and Down Button to adjust this number as needed. If no button is pressed for about 4 seconds, the pump will save the value and return to the previous screen.

3.4.1.3.2 Multiply Mode (for AD8)

The pump is in Multiply Mode when a multiplication symbol (X) is shown on the left-hand side of the LCD Display. Use the Up Button and Down Button to select the number of strokes that will occur for each incoming pulse. Once the Power Button is pushed to turn the pump on, the LCD Display will count down the number of strokes starting at the multiplier value each time a pulse input is recognized. The strokes will occur every half second until it has counted down to zero. The pump will then wait for the next pulse input.

If it is necessary to change the pulse duration required to recognize a pulse from the factory default of 60 ms, hold both the Up Button and Down Button until a number appears followed by the letter 'm'. This number is the minimum required time in milliseconds needed to count as a pulse. Use the Up Button and Down Button to adjust this number as needed. If no button is pressed for about 4 seconds, the pump will save the value and return to the previous screen.

3.4.1.3.3 Analog Mode (for AD8)

The pump is in Analog Mode when 'mA' is shown on the left-hand side of the LCD Display.

Pressing the Up or Down Button will display 'P1' and the milliamp input that corresponds to zero strokes. The Up and Down Buttons can be used to adjust this value. Pressing the Power Button (or waiting for about 8 seconds) will display 'P2' and the milliamp input that corresponds to max stroke rate. Note that the maximum stroke rate will be either 120 strokes per minute or 59 strokes per hour. This depends on the stroke speed set in Internal Mode.

SECTION 4 - MAINTENANCE

4.0 SPARE PARTS REPLACEMENT AND ROUTINE MAINTENANCE

LMI® metering pumps are designed for trouble-free operation, yet routine maintenance of elastomeric parts is essential for optimum performance. This involves replacing the LIQUIFRAM™, cartridge valves, O-rings, and the injection check valve spring. LMI® recommends replacing these parts at least once a year; however, frequency will depend on your particular application.

4.1 DEPRESSURIZING THE DISCHARGE LINE (FOR PUMPS EQUIPPED WITH A 4-FV ONLY)

CAUTION ALWAYS WEAR PROTECTIVE CLOTHING, FACE SHIELD, SAFETY GLASSES AND GLOVES WHEN PERFORMING ANY MAINTENANCE OR REPLACEMENT ON YOUR PUMP.

CAUTION TO REDUCE THE RISK OF CHEMICAL SPLASH DURING DISASSEMBLY OR MAINTENANCE, ALL INSTALLATIONS SHOULD BE EQUIPPED WITH LINE DEPRESSURIZATION CAPABILITY. USING LMI®'S FOUR-FUNCTION VALVE (4-FV) IS ONE WAY TO INCLUDE THIS FEATURE.

CAUTION READ STEPS 1 AND 2 BELOW BEFORE PROCEEDING.

1. Be sure the Injection Check Valve is properly installed and is operating. If a shut off valve has been installed downstream of the Injection Valve, it should be closed.

CAUTION BE SURE YOUR RELIEF TUBING IS CONNECTED TO YOUR 4-FV AND RUNS BACK TO YOUR SOLUTION DRUM OR TANK.

2. Turn the black knob on the 4-FV 1/8 turn to the stop. Turn and hold the yellow knob for a few seconds. The discharge line is now depressurized. Keep both valve knobs open until solution drains back down the discharge tubing into the solution tank or drum. Then release the yellow knob, and turn the black knob to its normal position.

4.2 DEPRESSURIZING THE DISCHARGE LINE (FOR DOUBLE BALL FASTPRIME™ HEADS ONLY)

CAUTION ALWAYS WEAR PROTECTIVE CLOTHING, FACE SHIELD, SAFETY GLASSES AND GLOVES WHEN PERFORMING ANY MAINTENANCE OR REPLACEMENT ON YOUR PUMP.

CAUTION READ STEPS 1 AND 2 BELOW BEFORE PROCEEDING.

1. Be sure the Injection Check Valve is properly installed and is operating. If a shut off valve has been installed downstream of the Injection Valve, it should be closed.

CAUTION BE SURE YOUR RELIEF TUBING IS CONNECTED TO YOUR FASTPRIME™ VALVE AND RUNS BACK TO YOUR SOLUTION DRUM OR TANK.

2. Turn the FASTPRIME™ knob one-and-a-half turns counter-clockwise. The discharge line is now depressurized. Keep valve open until solution drains back down the discharge tubing into solution drum or tank. Then turn the knob clockwise to tighten knob to closed position.

4.3 LIQUIFRAM™ (DIAPHRAGM) REPLACEMENT

▲ CAUTION ALWAYS WEAR PROTECTIVE CLOTHING, FACE SHIELD, SAFETY GLASSES AND GLOVES WHEN WORKING NEAR OR PERFORMING ANY MAINTENANCE OR REPLACEMENT ON YOUR PUMP. SEE SDS INFORMATION FROM SOLUTION SUPPLIER FOR ADDITIONAL PRECAUTIONS.

LMI® metering pumps are designed for trouble-free operation, yet routine maintenance of elastomeric parts is essential for optimum performance. This involves replacing the LIQUIFRAM™, cartridge valves, O-rings and the injection check valve spring. LMI® recommends replacing these parts at least once a year; however, frequency will depend on your particular application.

When replacing the LIQUIFRAM™, the cartridge valves, or O-rings, the injection check valve spring should also be replaced (see next Section 4.4). A Spare Parts Kit or RPM PRO PAC™ kit containing these parts may be obtained from your local distributor.

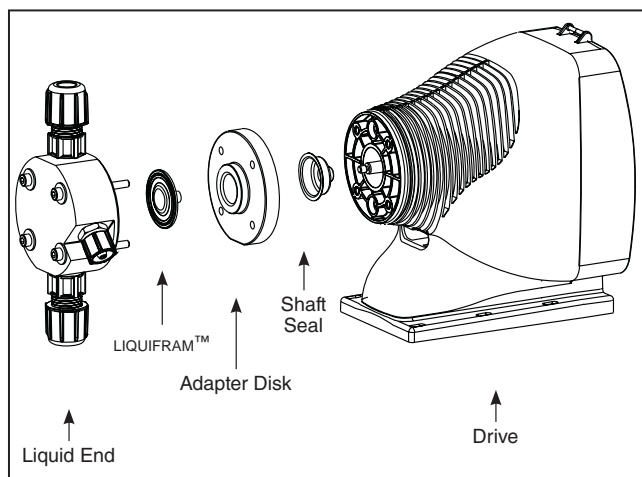

Figure 15. LIQUIFRAM™ (Diaphragm) Replacement

Replacing the LIQUIFRAM™:

1. Carefully depressurize, drain, and disconnect the discharge line (see previous sections in this manual).

2. Place the Foot Valve into a container of water or other neutralizing solution. Turn the pump on to flush the head assembly. Once the pump head has been flushed, lift the Foot Valve out of the solution and continue to pump air into the pump head until the pump head is purged of water or neutralizing solution.

Note:

If the liquid cannot be pumped due to LIQUIFRAM™ rupture, carefully disconnect the suction and discharge tubing using protective clothing, gloves and face shield, immerse the head in water or other neutralizing solution.

3. Remove the four metric screws and washers from the head using an M4 Allen wrench.
4. Start the pump. While running, set the Stroke Adjustment Knob to 0% and then turn the pump off.
5. With the unit off, unscrew the LIQUIFRAM™ by carefully grasping the outer edge and turning it counter-clockwise \cup . Discard old LIQUIFRAM™. Remove the Adapter Disk (located behind the LIQUIFRAM™) and ensure that the diameter of the raised section is the same as the diameter of the replacement LIQUIFRAM™.
6. Check condition of the Shaft Seal. Replace Shaft Seal if necessary.
7. Replace the Adapter Disk so that the drain hole of the disk is oriented downward, and the mounting holes line up with the mounting holes of the pump.

▲ CAUTION BE CAREFUL NOT TO SCRATCH THE FLUOROFILM™ FACE OF THE NEW LIQUIFRAM™.

8. Screw on the new LIQUIFRAM™ clockwise until turned all the way in. Start the pump and turn the stroke knob to 100%. Stop the pump.
9. Remount the pump head using the four (4) screws and washers. Tighten in a criss-cross pattern. Torque screws to 25 inch-pounds. After one week of operation, recheck the screws and tighten if necessary.

SECTION 4 - MAINTENANCE

4.4 CARTRIDGE VALVE AND O-RING REPLACEMENT

▲ CAUTION ALWAYS WEAR PROTECTIVE CLOTHING, FACE SHIELD, SAFETY GLASSES AND GLOVES WHEN WORKING ON OR PERFORMING ANY MAINTENANCE OR REPLACEMENT ON YOUR PUMP. SEE SDS INFORMATION FROM SOLUTION SUPPLIER FOR ADDITIONAL PRECAUTIONS.

Refer to the LMI® Metering Pump Price List for the proper Spare Parts Kit or RPM PRO PAC™ kit number or contact your local LMI® stocking distributor.

1. Carefully depressurize and disconnect the discharge line (see Section 4.1 or 4.2 in this manual).
2. Place the Foot Valve into a container of water or other neutralizing solution. Turn the pump on to flush the head assembly. Once the pump has been flushed, lift the Foot Valve out and continue to pump to let air into the pump head until pump is purged of water or neutralizing solution.

Note:

If the liquid cannot be pumped due to LIQUIFRAM™ rupture, carefully disconnect the suction and discharge tubing using protective clothing, gloves and face shield. Remove the four screws and washers from the head and immerse the head in water or other neutralizing solution.

Spare part replacement kits include specific instructions for valve replacement. Please follow the instructions included with the replacement kit.

3. Carefully disconnect one tubing connection and fitting at a time, then remove and replace the worn valve and O-rings. If necessary, carefully loosen stuck valves by prying side to side using a small screwdriver through the center hole of the valve.

Note:

Before disassembling the check valves, note the orientation of the valve.

4. Install new check valves in each location. Ensure that the cartridges are oriented correctly.

4.5 INJECTION CHECK VALVE PARTS REPLACEMENT

CAUTION DEPRESSURIZE AND DRAIN PIPELINE (OR ISOLATE INJECTION CHECK VALVE POINT USING VALVES) SO THAT INJECTION CHECK VALVE CAN SAFELY BE DISASSEMBLED.

CAUTION ALWAYS WEAR PROTECTIVE CLOTHING, FACE SHIELD, SAFETY GLASSES AND GLOVES WHEN WORKING NEAR OR PERFORMING ANY MAINTENANCE OR REPLACEMENT ON YOUR PUMP. SEE SDS INFORMATION FROM SOLUTION SUPPLIER FOR ADDITIONAL PRECAUTIONS.

Refer to the LMI® Metering Pump Price List for the proper Spare Parts Kit or RPM PRO PAC™ kit number or contact your local LMI® stocking distributor.

1. Isolate Injection Check Valve and depressurize pipe or drain pipeline.

2. Carefully depressurize and disconnect the discharge line (see Section 5.1 or 5.2 in this manual).

Spare part replacement kits include specific instructions for valve replacement. Please follow the instructions included with the replacement kit.

3. Carefully disconnect the tubing leading to the Injection Check Valve, then remove the Injection Check Valve Fitting. Remove and replace the worn spring, seat, ball, and O-ring.

Note:

Before disassembling the check valves, note the orientation of the valve.

4. Install a new spring, seat, ball, and O-ring. Ensure that the parts are oriented correctly.

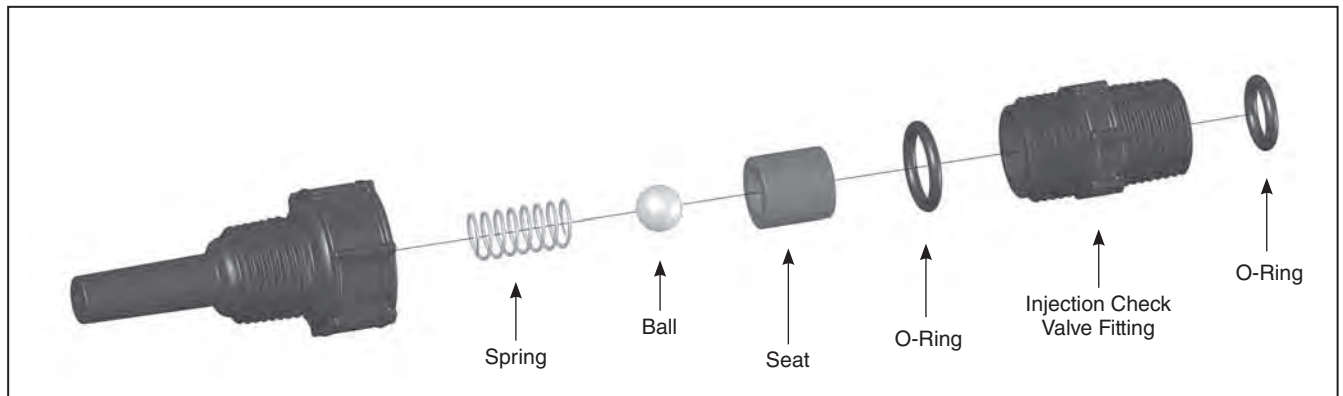

Figure 16. Injection Check Valve Parts Replacement

SECTION 4 - MAINTENANCE

4.6 FASTPRIME™ VALVE O-RING REPLACEMENT

CAUTION ALWAYS WEAR PROTECTIVE CLOTHING, FACE SHIELD, SAFETY GLASSES AND GLOVES WHEN PERFORMING ANY MAINTENANCE OR REPLACEMENT ON YOUR PUMP.

Refer to the LMI® Metering Pump Price List for the proper Spare Parts Kit or RPM PRO PAC™ kit number or contact your local LMI® stocking distributor.

1. Be sure the Injection Check Valve is properly installed and is operating. If a shut off valve has been installed downstream of the Injection Valve, it should be closed.

CAUTION BE SURE YOUR RELIEF TUBING IS CONNECTED TO YOUR FASTPRIME™ VALVE AND RUNS BACK TO YOUR SOLUTION DRUM OR TANK.

2. Turn the FASTPRIME™ Knob one-and-a-half turns counter-clockwise. This will depressurize the head. Keep valve open. Carefully remove the return line by gently pulling tubing and moving it from side to side to gradually back tubing off of the barbed fitting.

3. Hold return line tubing upright until solution drains back into solution drum or tank.
4. Using a 3/4" (or 19mm) socket or wrench remove Retaining Nut, and pull out the entire FASTPRIME™ Valve assembly. Remove and replace the two small O-rings.
5. Reinsert the FASTPRIME™ Valve assembly and retighten the Retaining Nut. Then turn the FASTPRIME™ Knob clockwise to tighten knob to closed position. To avoid damaging the parts, it is important that the flange on the FASTPRIME™ Valve is flush with the Retaining Nut prior to reassembly.
6. Recut 1 to 2 inches off the tip of the return line and ensure the end is squared. Press the return line tubing on completely past the barbs.

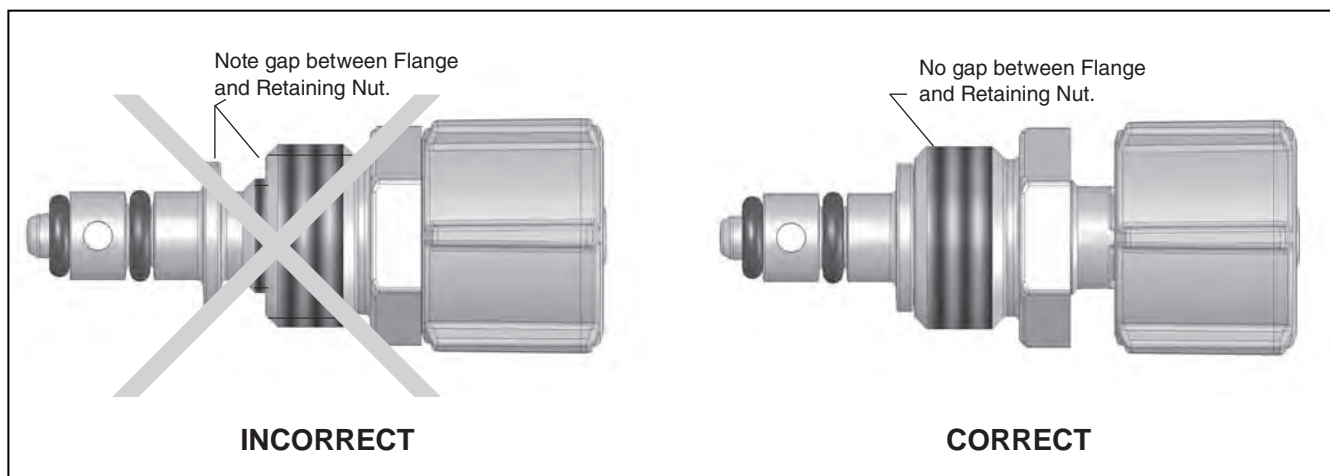

Figure 17a

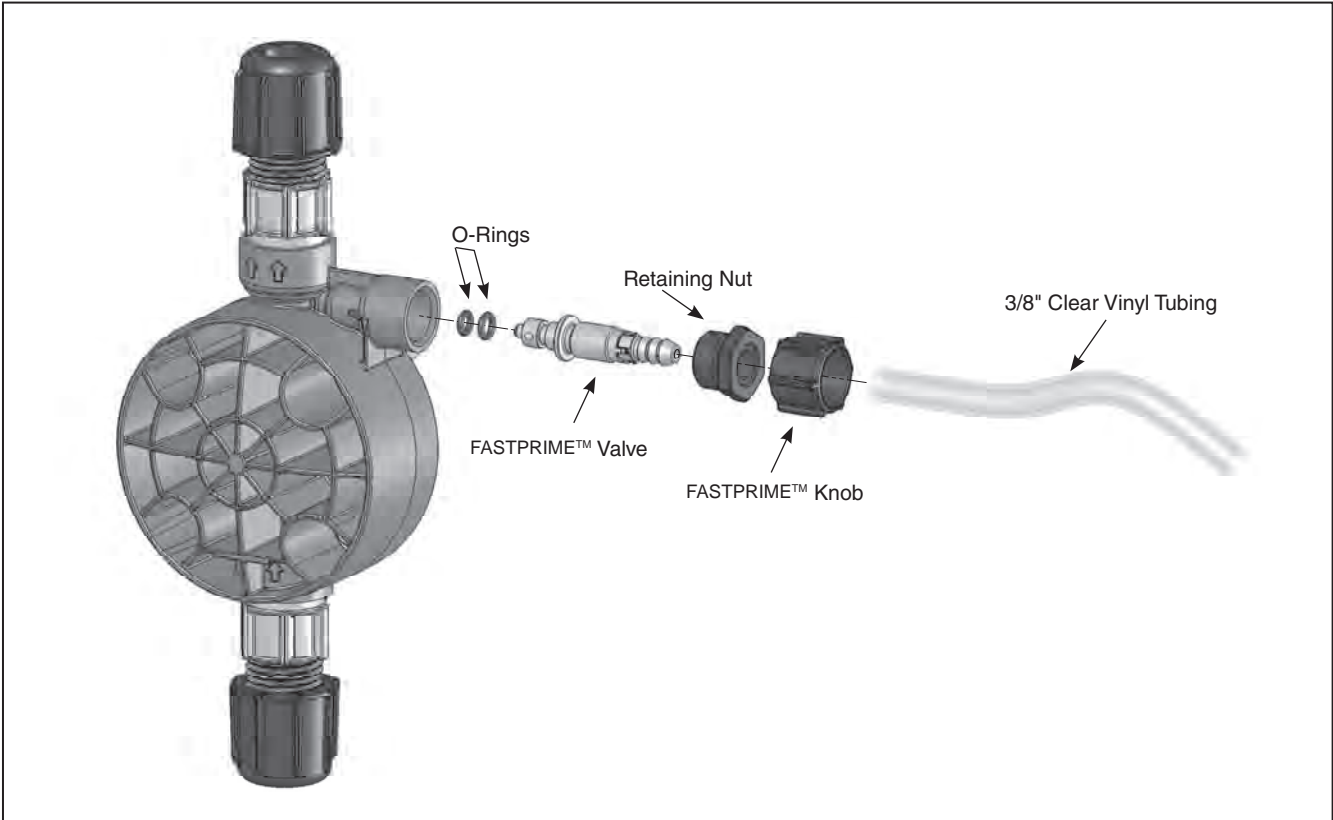

Figure 17b. FASTPRIME™ Valve O-Ring Replacement

SECTION 4 - MAINTENANCE

4.7 DRIVE PARTS LIST

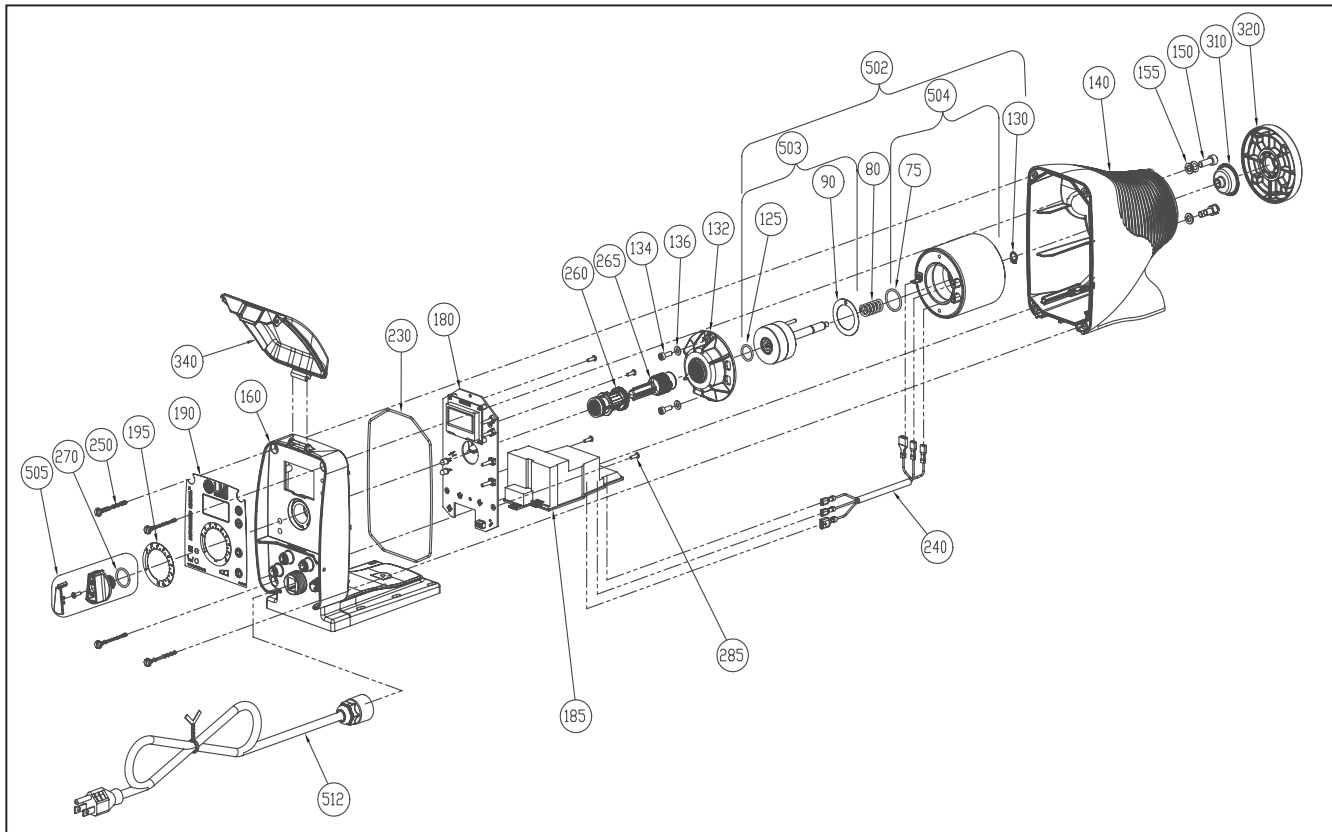

Figure 18. Drive Parts List

Bubble Number	Description	Bubble Number	Description
75	EPU O-Ring	195	Stroke Dial
80	EPU Return Spring	230	Control Panel O-Ring
90	EPU Shim	240	Wire Harness
125	Plunger O-Ring	250	Drive Assembly Screws
130	Retaining Ring	260	Female Stroke Shaft
132	Stroke Bracket	265	Male Stroke Shaft
134	Stroke Bracket Screw	270	Stroke Shaft O-Ring
136	Stroke Bracket Washer	285	PCB Attachment Screw
140	Drive Housing	310	Shaft Seal
150	EPU Attachment Bolt	320	Adapter Disk
155	EPU Attachment Washer	340	Clear Cover
160	Control Panel	502	EPU Assembly
180	Control Board	503	Plunger Assembly
185	Power Board	504	Pole Piece Assembly
190	Nameplate	505	Stroke Knob Assembly
		512	Power Cord Assembly

Table 3. Drive Parts List

4.8 EPU WIRING DIAGRAM

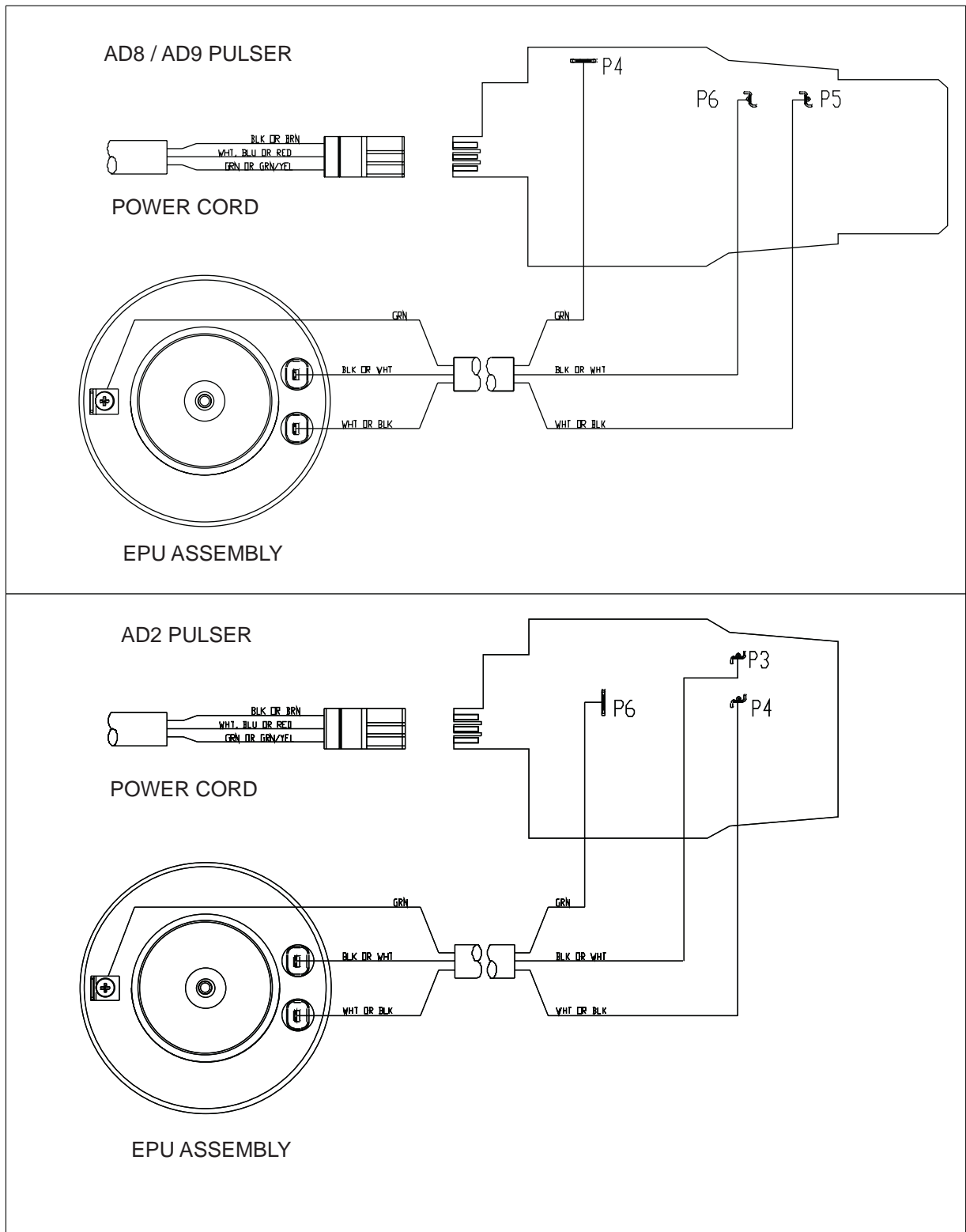

Figure 19. EPU Wiring Diagram

SECTION 4 - MAINTENANCE

4.9 LIQUID END PARTS

For the latest and most accurate information on your liquid end, please refer to the Liquid End Sheets available in the LMI® Online Library at: www.lmipumps.com.

1. Select "Online Literature Library" in the Navigation Bar on left.

2. Once on Online Literature Library use "Product" drop down to select "Liquid Handling Assemblies."

3. Select "Gallery" or "Index" to view Liquid End sheets.

The following images are for reference and may not represent your particular liquid end.

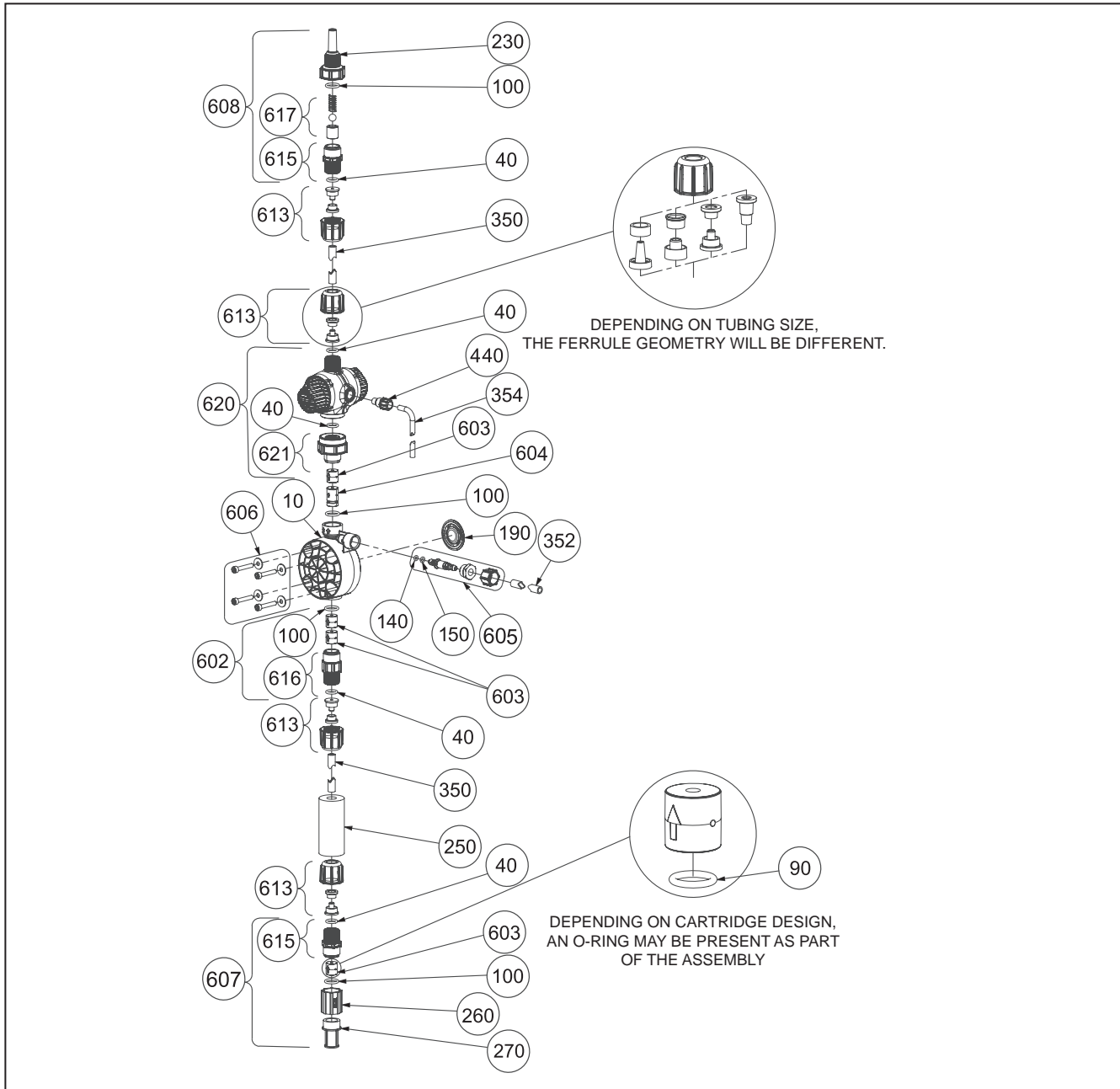

Figure 20. FASTPRIME™ Liquid End Assembly

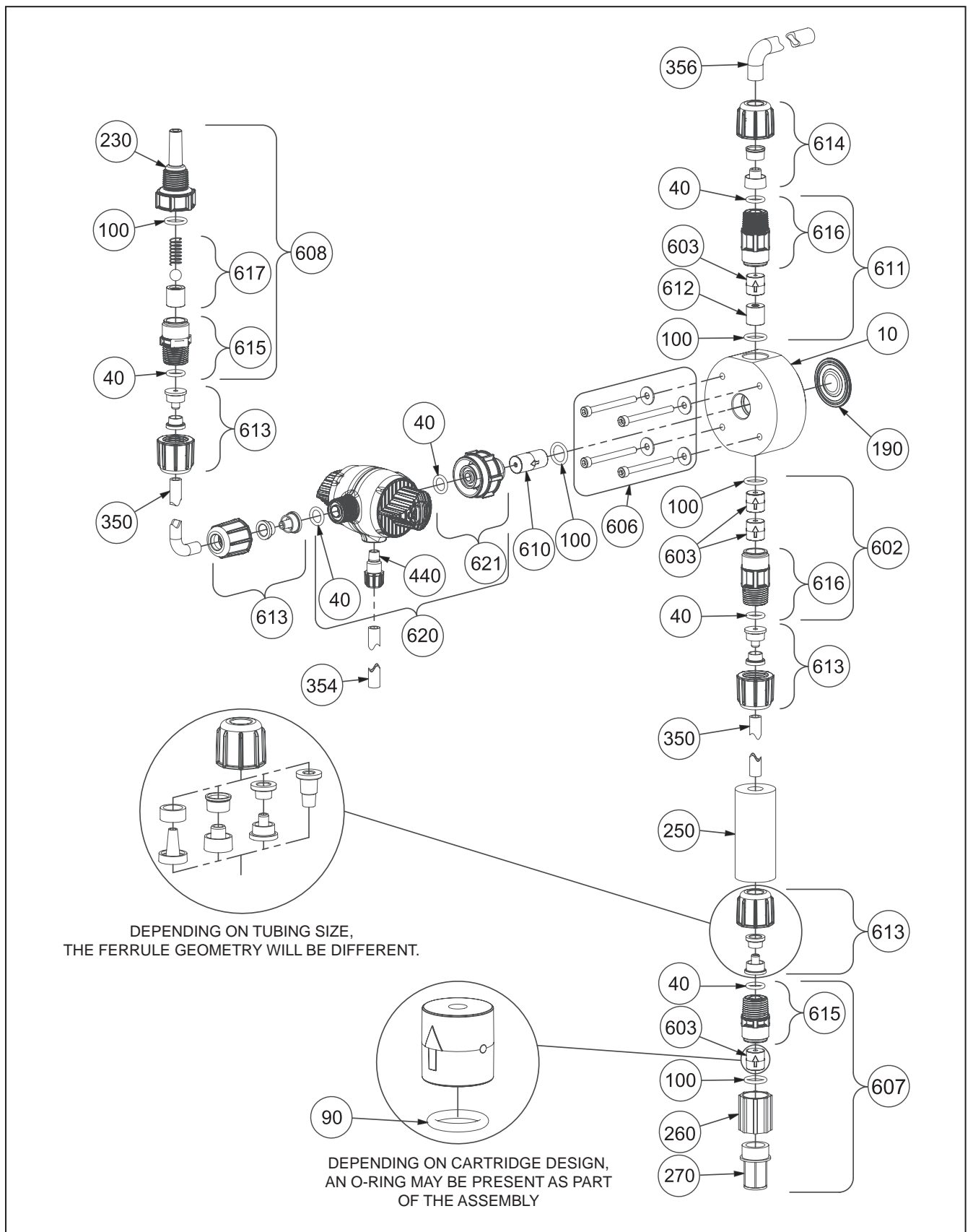

Figure 21. AUTOPRIME™ Liquid End Assembly

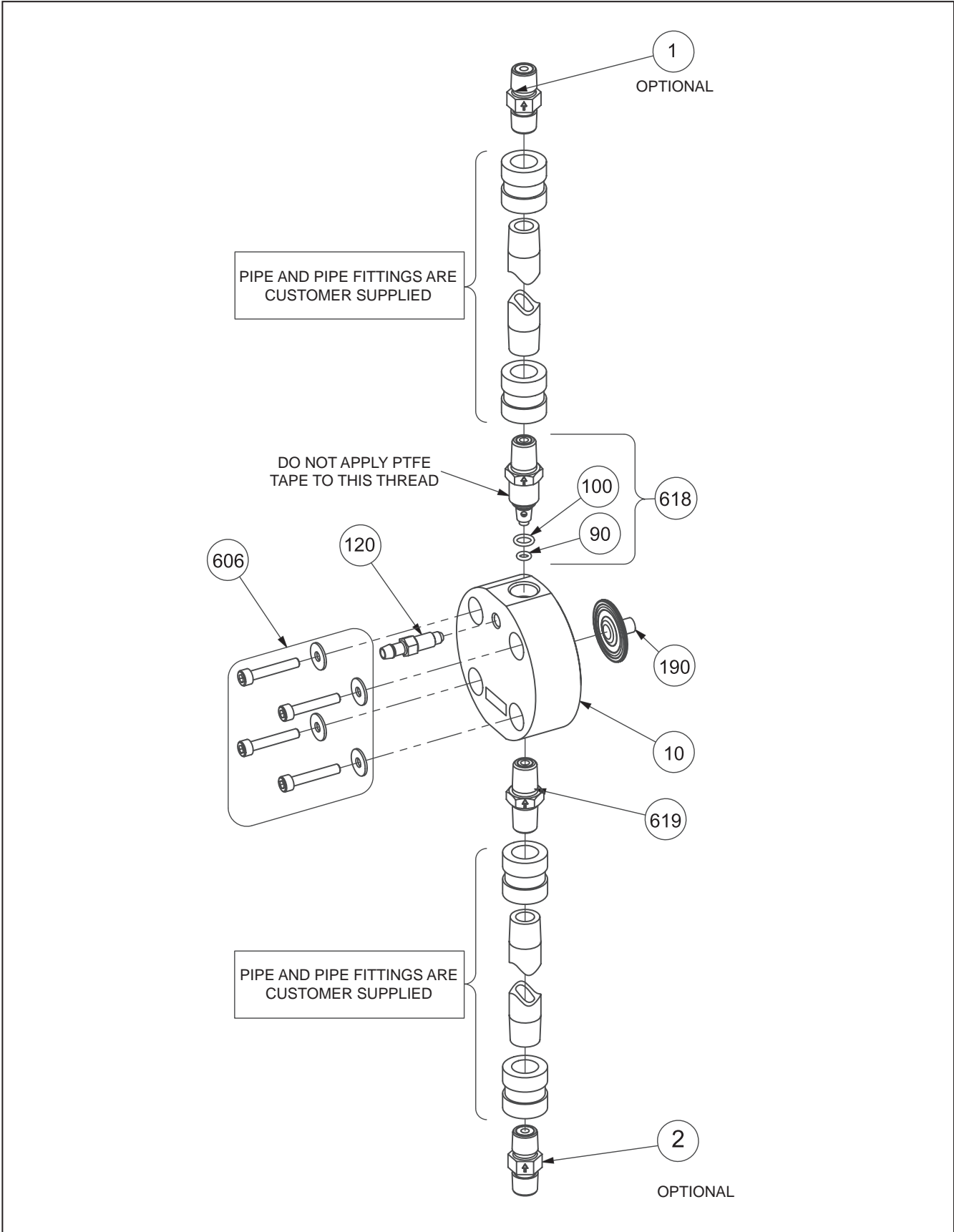
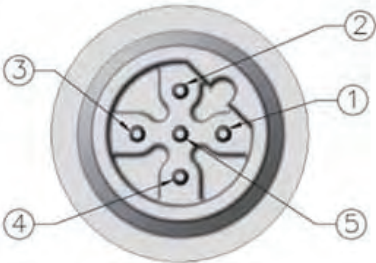

Figure 22. Stainless Steel Liquid End Assembly



5 PIN CONNECTOR

USE 5 PIN CABLE (LMI P/N 48414)

PIN	WIRE	SIGNAL
1	Brown	Remote On-Off
2	White	Ground-Return
3	Blue	External Pulse Input
4	Black	Power Supply, 24V 75 mA
5	Green-Yellow	4-20 mA Input

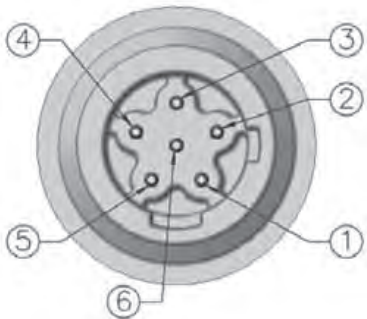

6 PIN CONNECTOR

USE 6 PIN CABLE (LMI P/N 49035)

PIN	WIRE	SIGNAL
1	Red-White	Alarm Output or Internal-External indicator
2	Red	Alarm Return
3	Green	Remote Internal-External mode
4	Red-Yellow	Pulse Output
5	Red-Black	4-20 mA Output
6	Red-Blue	Ground-Return

SECTION 5 - WIRING DIAGRAMS

INPUT WIRING DIAGRAM

HALL EFFECT FLOWMETER INPUT CONNECTION REFERENCE:

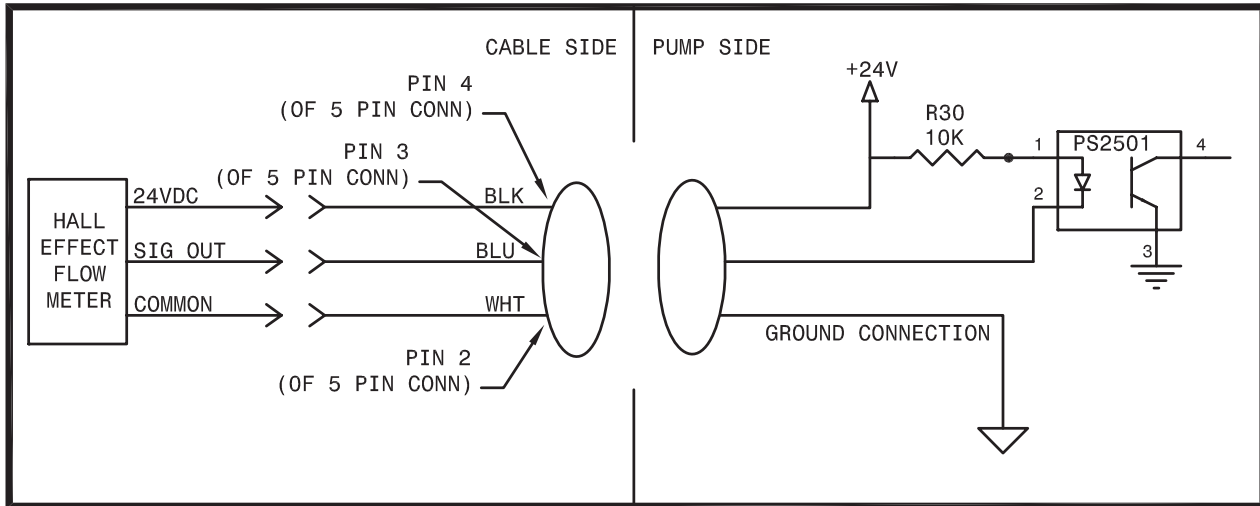

TANK ON INPUT CONNECTION REFERENCE:

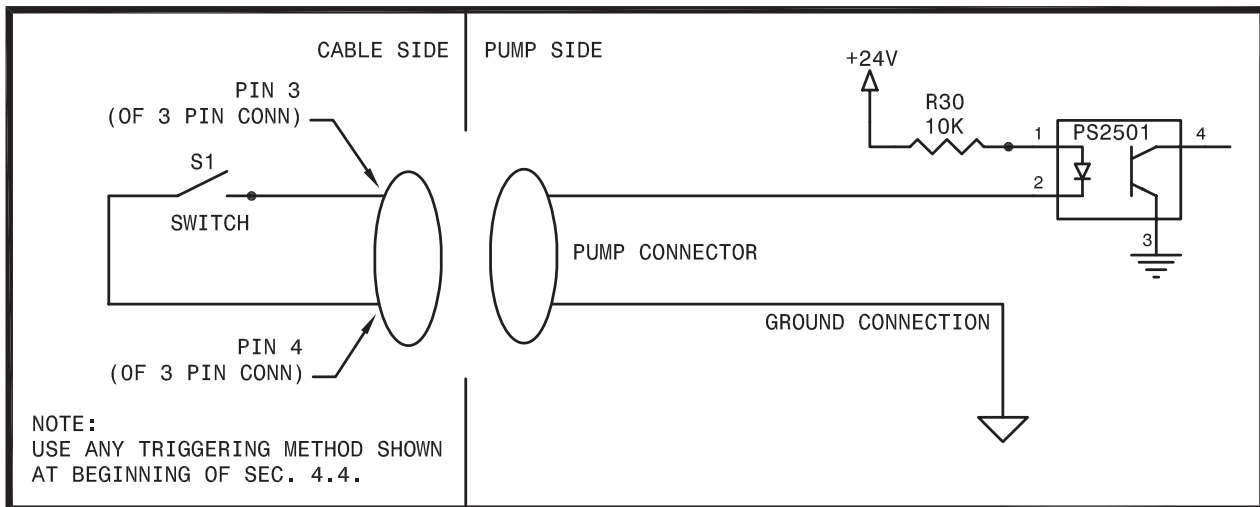

NOTE:

A Cable Cord set for this application is included with an optional LMI® dual switch assembly P/N 49249.

INPUT WIRING DIAGRAM

**TANK EMPTY
INPUT CONNECTION REFERENCE:**

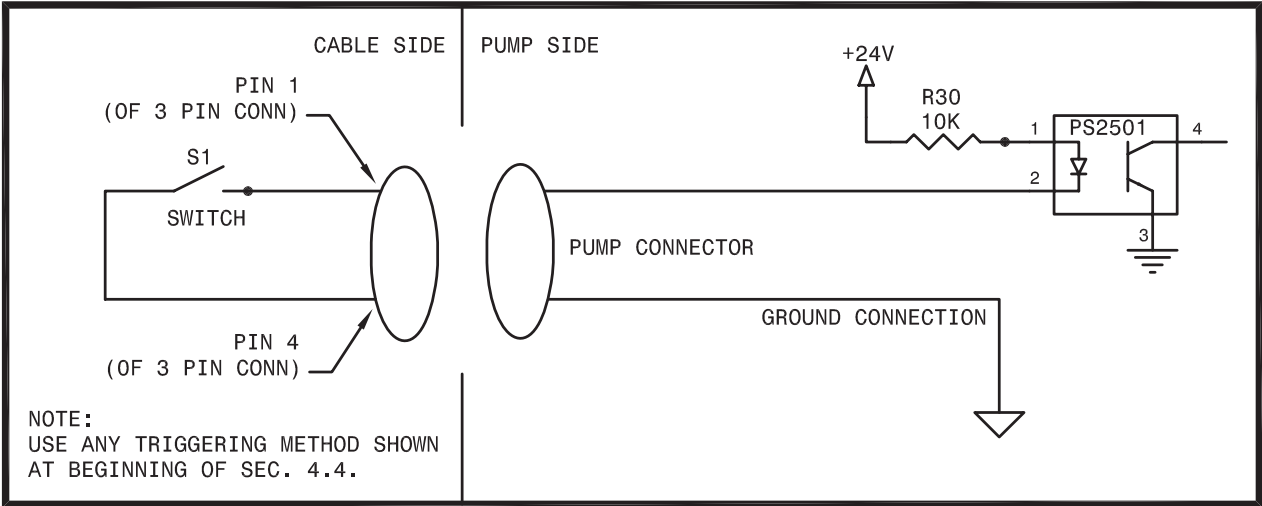

NOTE:
A Cable cord set for this application is included with an optional LMI® low level switch assembly P/N 49246 or a LMI® dual level switch assembly P/N 49249.

**REMOTE ON-OFF
INPUT CONNECTION REFERENCE:**

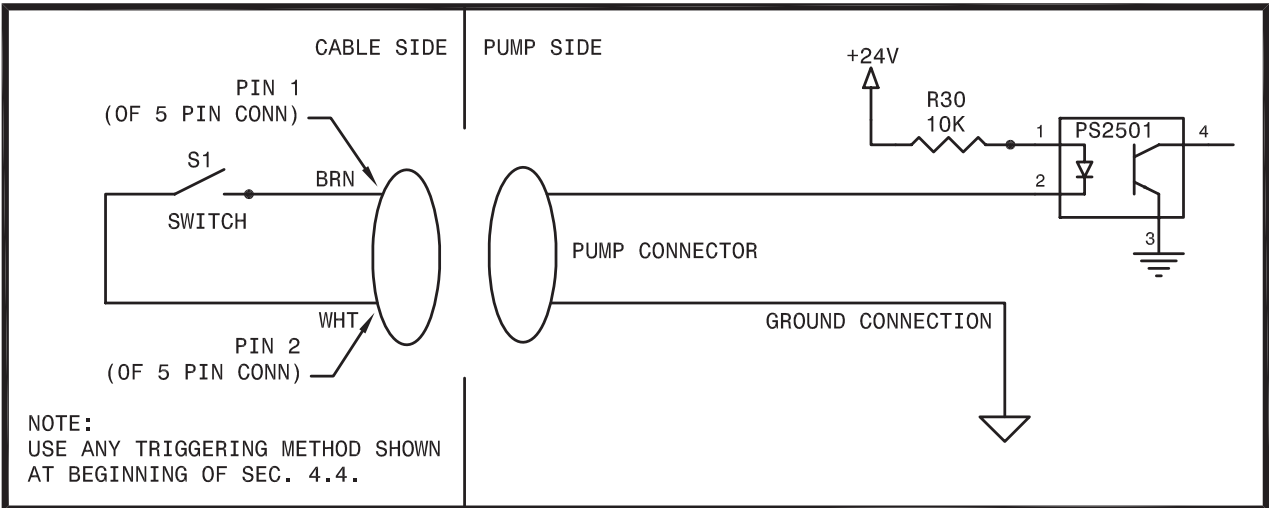

SECTION 5 - WIRING DIAGRAMS

INPUT WIRING DIAGRAM

EXTERNAL PULSE INPUT CONNECTION REFERENCE:

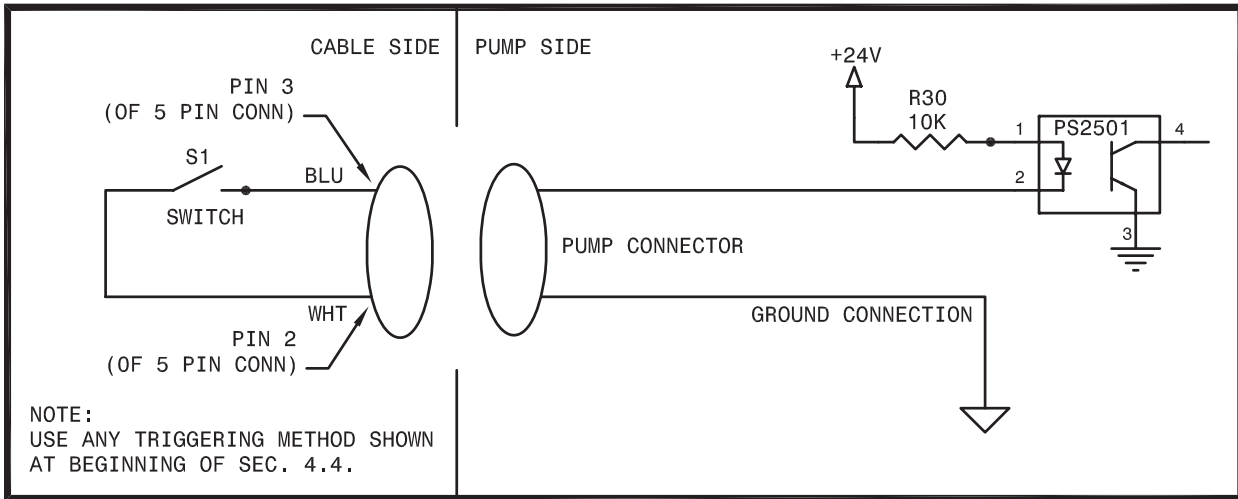

INTERNAL / EXTERNAL CONTROL INPUT CONNECTION REFERENCE:

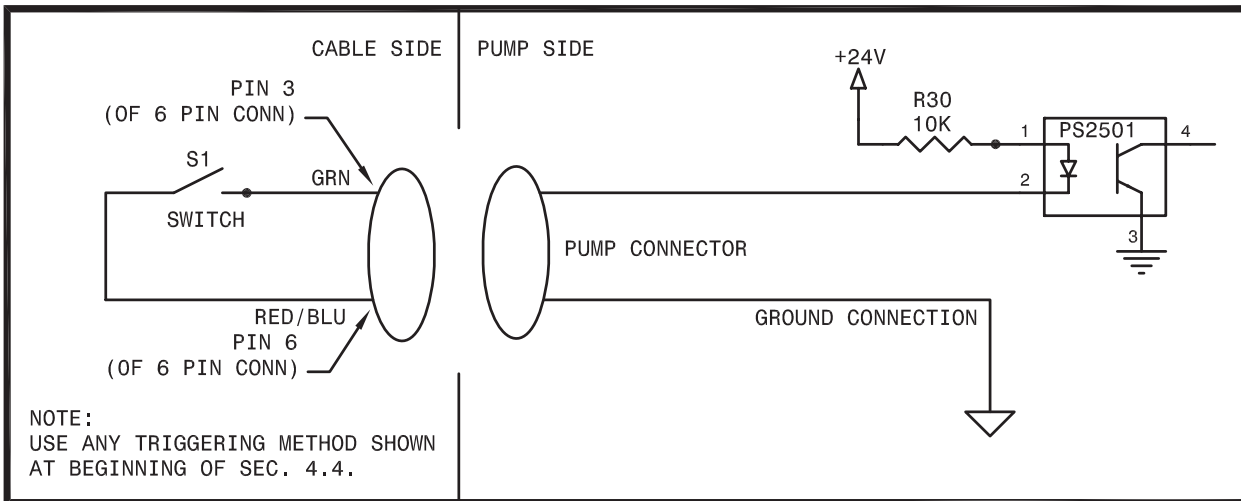

INPUT WIRING DIAGRAM

4 - 20 MA
INPUT CONNECTION REFERENCE:

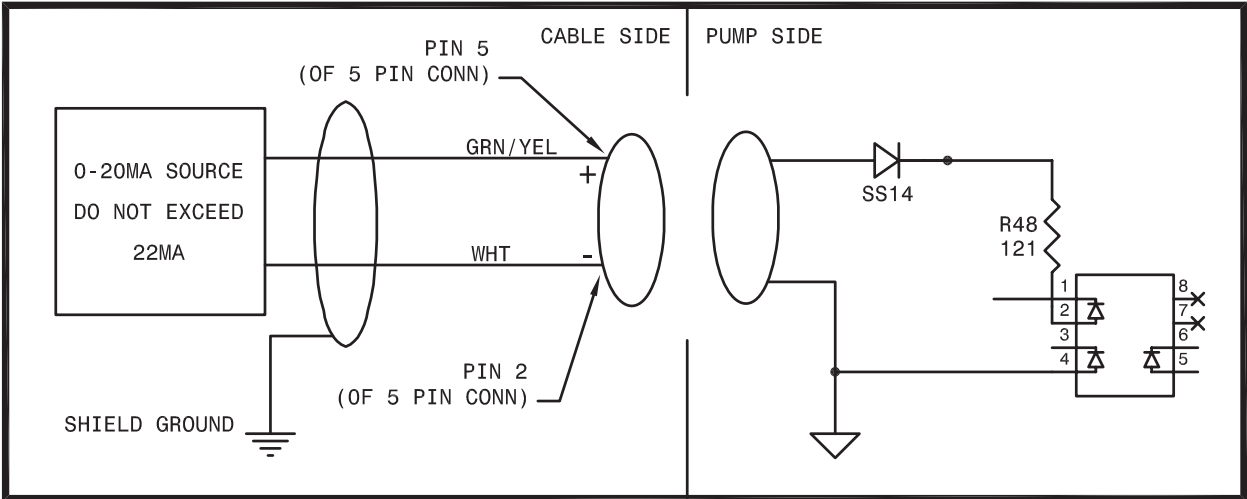

NOTE:
0 to 20 input impedance is dynamic and will work with supply currents needing 130 Ohm or above impedance.

SECTION 5 - WIRING DIAGRAMS

OUTPUT WIRING DIAGRAM

PULSE OUTPUT CONNECTION REFERENCE:

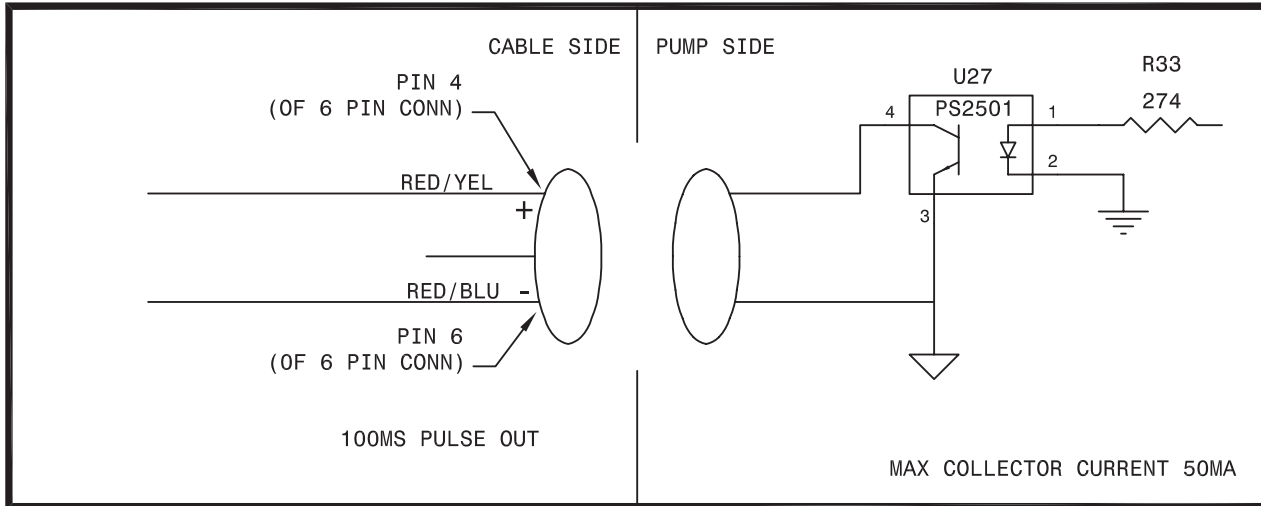

NOTE:

When using a "PULL UP" option use a 10K resistor and a 24VDC source (can be used with Pin 5 of 5 Pin CONN).

4 TO 20 MA OUTPUT CONNECTION REFERENCE:

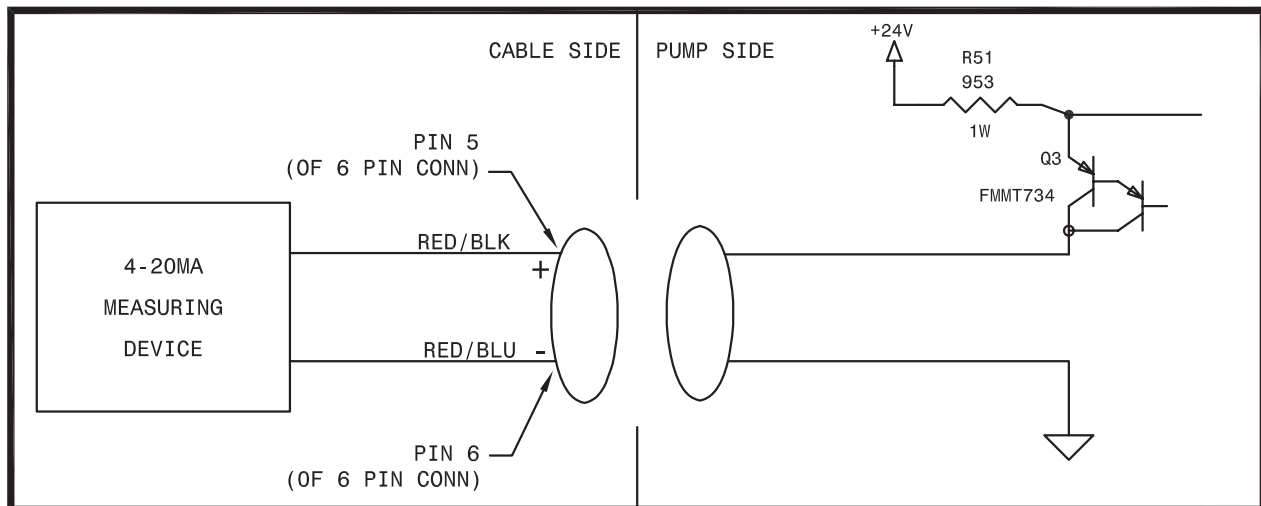

OUTPUT WIRING DIAGRAM

ALARM
OUTPUT CONNECTION REFERENCE:

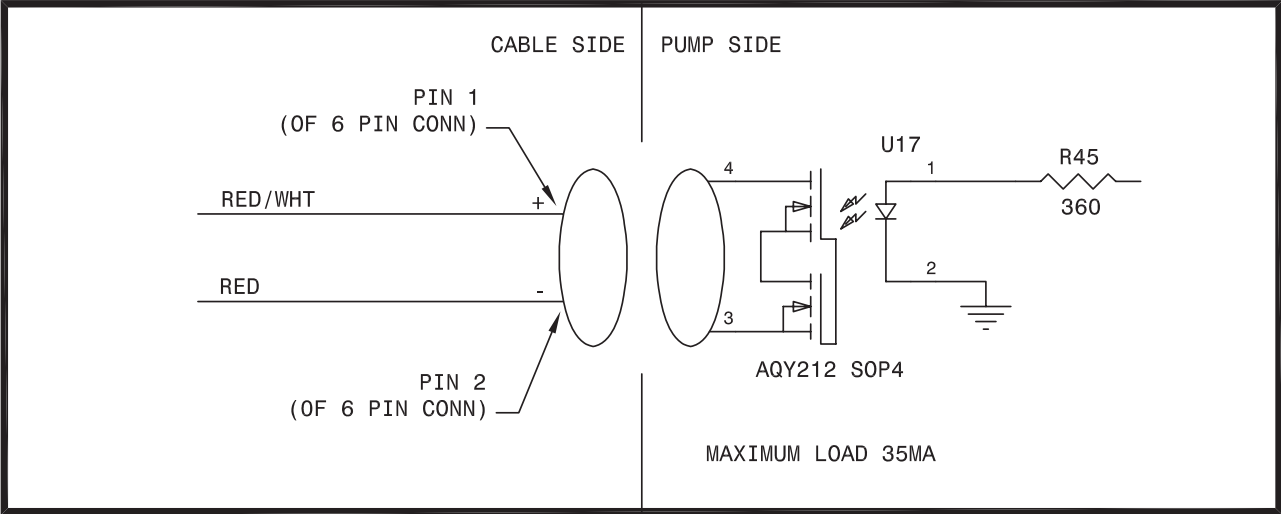

NOTE:
Use to switch on 24V source or less. Do not use to switch on AC line Voltage without Relay.
Relay coils should be 24VDC or less with maximum Current of 35 mA.

SECTION 6 - TROUBLESHOOTING

PROBLEM	POSSIBLE CAUSE	SOLUTION
Pump Will Not Prime	1. Pump not turned on or plugged in.	1. Turn on pump/plug in pump.
	2. Output dials not set properly.	2. Always prime pump with speed and stroke at 100%.
	3. Foot Valve not in vertical position on bottom of tank.	3. Foot Valve must be vertical (<i>see Foot Valve Installation, Section 2.7</i>).
	4. Pump suction lift too high.	4. Maximum suction lift is 5 ft (1.5 m). Pumps with High Viscosity Liquid Handling Assemblies require flooded suction.
	5. Suction tubing is curved or coiled in tank.	5. Suction tubing must be vertical. Use LMI® ceramic weight supplied with pump (<i>see Section 2.7</i>).
	6. Fittings are over tightened.	6. Do not overtighten fittings. This causes seal rings to distort and not seat properly which causes pump to leak back or lose prime.
	7. Air trap in suction valve tubing.	7. Suction tubing should be as vertical as possible. AVOID FALSE FLOODED SUCTION! (<i>see Section 2.2.1</i>).
	8. Too much pressure at discharge (Pumps without multi-function valve.)	8. Shut off valves in pressurized line. Disconnect tubing at injection check valve (<i>see Priming Section 3.2</i>). When pump is primed, reconnect discharge tubing.
	9. Air leak around fitting.	9. Check for missing or damaged O-rings at ends of fittings.
Pump Loses Prime	1. Solution container ran dry.	1. Refill container with solution and reprime (<i>see Section 3.2</i>).
	2. Foot Valve is not in a vertical position on the bottom of the tank.	2. Foot Valve must be vertical (<i>see Foot Valve Installation, Section 2.7</i>).
	3. Pump suction lift is too high.	3. Maximum suction lift is 5 ft (1.5 m). Pumps with High Viscosity Liquid Handling Assemblies require flooded suction.
	4. Suction tubing is curved or coiled in tank.	4. Suction tubing must be vertical. Use LMI® ceramic weight supplied with pump (<i>see Section 2.7</i>).
	5. Fittings are over tightened.	5. DO NOT OVERTIGHTEN FITTINGS. This causes seal rings to distort and not seat properly which causes pump to leak back or lose prime.
	6. Air trap in suction valve tubing.	6. Suction tubing should be as vertical as possible. AVOID FALSE FLOODED SUCTION! (<i>see Section 2.2.1</i>).
	7. Air leak on suction side.	7. Check for pinholes, cracks. Replace if necessary.

PROBLEM	POSSIBLE CAUSE	SOLUTION
Leakage at tubing	1. Worn tubing ends.	1. Cut about 1 in (25 mm) off tubing and then replace as before.
	2. Loose or cracked fitting.	2. Replace fitting if cracked. Carefully hand tighten fittings. DO NOT USE PIPE WRENCH. An additional 1/8 or 1/4 turn may be necessary.
	3. Worn seal rings.	3. Replace balls and seal rings(see <i>Section 4.4</i>).
	4. Solution attacking Liquid Handling Assembly.	4. Consult your local distributor for alternate materials.
Low Output or Failure to Pump Against Pressure	1. Pump's maximum pressure rating is exceeded by injection pressure.	1. Injection pressure cannot exceed pump's maximum pressure. See pump data plate.
	2. Worn Seal Rings.	2. Worn seal rings or cartridge valves may need replacement (see <i>Section 4.4</i>).
	3. Ruptured LIQUIFRAM™.	3. Replace LIQUIFRAM™ (see <i>Section 4.3</i>).
	4. Incorrect stroke length.	4. Recalibrate Output (see <i>Section 3.3.2</i>).
	5. Tubing run on discharge may be too long.	5. Longer tubing runs may create frictional losses sufficient to reduce pump's pressure rating Consult factory for more information.
	6. Clogged Foot Valve strainer.	6. Remove Foot Valve strainer when pumping slurries or when solution particles cause strainer to clog.
Failure to Run	1. Pump not turned on or plugged in.	1. Turn on or plug in pump.
	2. EPU failure.	2. Disassemble pump and measure resistance across the EPU terminals. If this measures as an open circuit then the EPU should be replaced. (see <i>Section 4.8</i>).
	3. Pulser failure.	3. The pulser should be replaced if EPU checks out OK. Consult supplier or factory.
Excessive Pump Output	1. Syphoning. (Pumping downhill without a multi-function valve).	1. Move injection point to a pressurized location or install an LMI® 4-FV (see <i>Section 2.4</i>).
	2. Little or no pressure at injection point.	2. If pressure at injection point is less than 25 psi (1.7 Bar), an LMI® 4-FV should be installed see <i>Section 2.4</i>).
	3. Excessive strokes per minute.	3. Replace pulser or resistor. Consult factory.



LMI[®]

an Accudyne Industries brand



ROYTRONIC EXCEL[™] Series AD9 Programming Guide Electronic Metering Pumps

Manual No : 2032
Rev. : D
Rev. Date : 11/2015



LMI[®]

an Accudyne Industries brand

The Series AD9 electronic metering pump offers an extensive range of features, including microprocessor control for accurate and flexible automation in response to instrument signals. The microprocessor design employs a graphical display and tactile response keypad. All external inputs and outputs are opto-isolated from the microprocessor.

This manual is a supplement which describes programming and operation for the AD9 series. For complete details on Installation, Maintenance and Troubleshooting, please refer to the ROYTRONIC EXCEL™ Instruction Manual (P/N 2024).

⚠ CAUTION SPECIFIC PRECAUTIONS SHOULD BE TAKEN WHEN WORKING WITH ALL LMI® METERING PUMPS. PLEASE REFER TO THE PRECAUTIONS SECTION, SEC. 1.0, OF THE ROYTRONIC EXCEL™ INSTRUCTION MANUAL (P/N 2024).

SECTION 2 - FEATURES

1. Stroke speed adjustment 1-59 SPH (strokes per hour) to 1-120 SPM (strokes per minute).
2. Operating mode selection.
3. Flexible slope adjustable response to mA input signals.
4. Divide or multiply (batch) incoming pulses (1 to 9999).
5. Batch accumulation option.
6. Timed event mode for internal operation.
7. Percent-of-time operation for internal and external modes.
8. Keypad locking.
9. Low-level warning and empty-level shutoff with alarm output.
10. Programmable flow monitoring with alarm output (with FM-ROY-9 DIGI-PULSE™).
11. Continuous non-volatile memory (EEPROM)-no battery required.
12. Remote ON/OFF control.
13. Remote Internal/External mode control.
14. Pulse (pacing) output.
15. Universal voltage input (95-240V) with automatic line voltage compensation and over voltage protection.
16. Programmable menu for optional features parameters.
17. Theoretical flow display.
18. Single-Point and Two-Point calibration.
19. Fixed-time priming mode.
20. Configurable output alarms.
21. 4-20mA output for remote monitoring of stroke speed.

SECTION 3 - KEYPAD/DISPLAY: DESCRIPTION AND FUNCTION

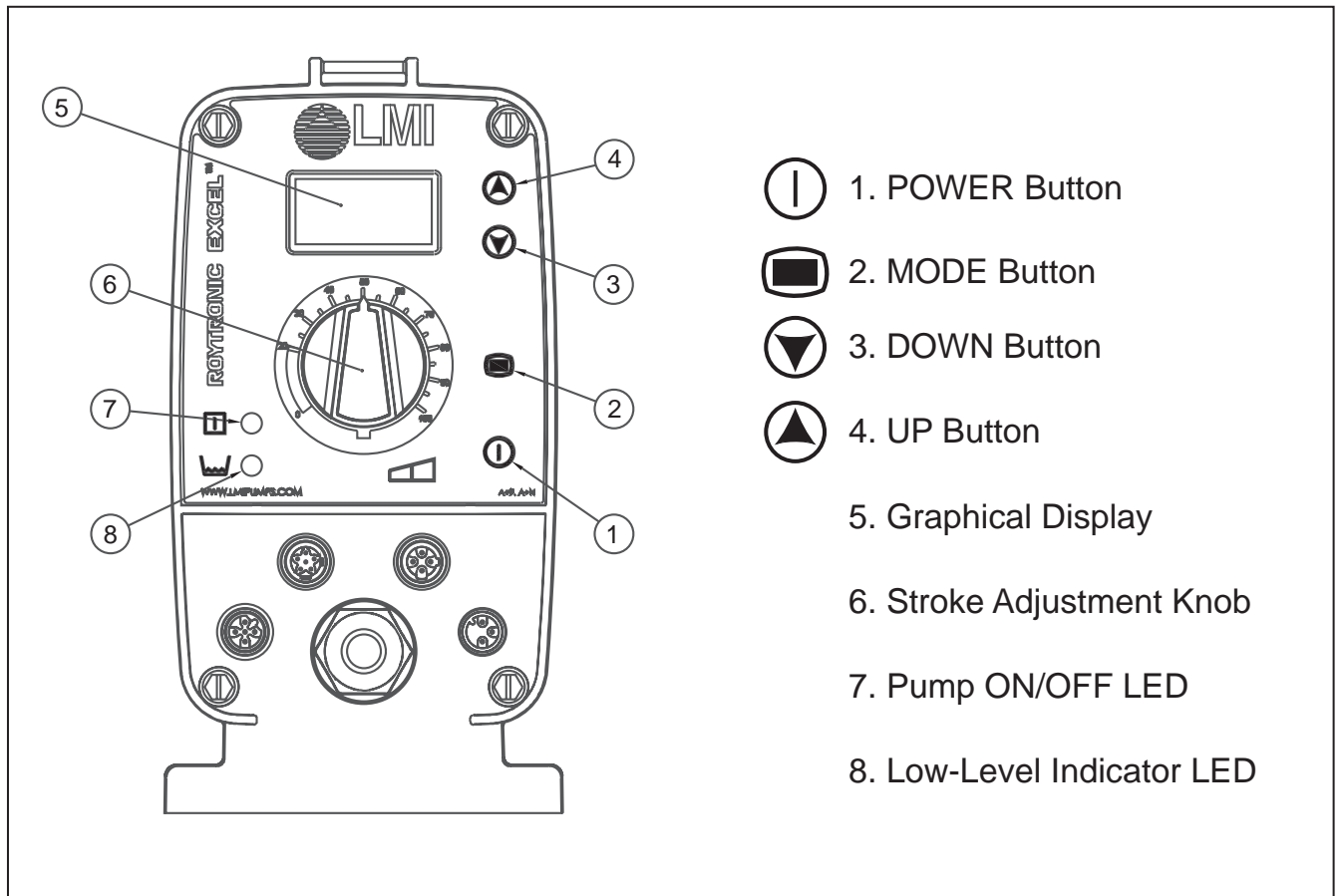







Figure 1. ROYTRONIC EXCEL™ Series AD9 Control Panel



3.1 POWER BUTTON

The  POWER button turns the pump ON or OFF. If the pump is not running, pressing this button will cause the pump to start running. If the pump is running, pressing the  POWER button will stop the pump. The  POWER button is also used to prime the pump as described in *Sec. 4.3*. When in a programming screen or a selection menu, the  POWER button is generally used to enter/select the associated item.

3.2 MODE SELECTION BUTTON

The  MODE button is used to enter the main selection menu. The  MODE button can also often be used to exit the current programming menu. Details of its use will be covered in greater detail later in this supplement.

3.3 UP AND DOWN BUTTONS

The  UP and  DOWN buttons are used to change parameters (i.e. stroke frequency) as well as to navigate the selection menus. These functions are covered in greater detail later in this supplement.

SECTION 3 - KEYPAD/DISPLAY: DESCRIPTION AND FUNCTION

3.4 GRAPHICAL DISPLAY

A graphical display is used to show the current operational state of the pump as well as a variety of specialized programming menus.

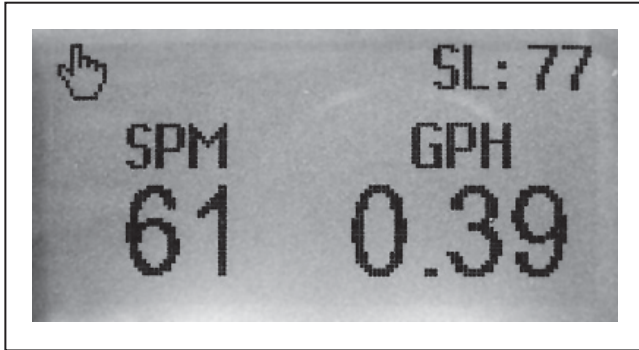

Manual Operating Mode Display

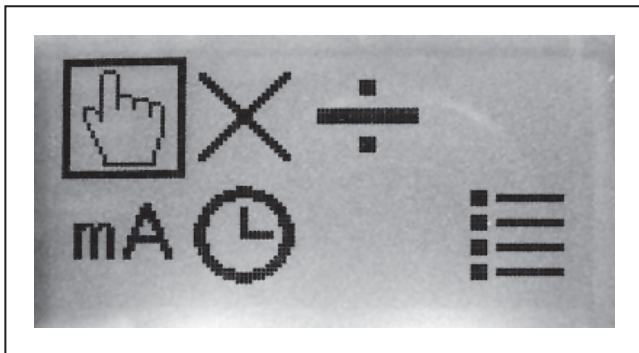

Control Mode Selection Display

3.5 STROKE ADJUSTMENT KNOB

The Stroke Adjustment Knob is used to adjust the stroke length of the pump. As this knob is adjusted, the stroke length and associated flow will be displayed on the current operating mode display.

3.6 PUMP ON/OFF LED

When the pump is started, the  Pump ON/OFF LED will be green when in internal mode and yellow when in an external mode. The LED will also briefly pulse OFF during an actual pump stroke. When the pump is not running, the Pump ON/OFF LED will be OFF.

3.7 LOW LEVEL INDICATOR LED

The  Low Level Indicator LED will normally be OFF. However, in the event that an external level sensor is connected to the pump, the LED will turn yellow if a Tank Low input signal is detected or red if a Tank Empty input signal is detected. If both Tank Low and Tank Empty conditions are present, the Tank Empty takes priority. The pump will not stroke when in a Tank Empty condition.

SECTION 4 - OPERATION OF THE SERIES AD9

This pump features EEPROM nonvolatile memory. The pump will always power up in the last used mode. When shipped from the factory the pump will power up in the Manual mode (see Sec. 5.1), with the pump OFF and a speed setting of 120 SPM.

NOTE:

If the power to the pump is cut less than 15 seconds after the last programmed values have been set, the latest changes will NOT be stored in nonvolatile memory. Allow at least 15 seconds before disconnecting from power to ensure that the latest changes are stored.

4.1 PUMP START/STOP

Press the **⏻** POWER button to start or stop the pump. When the pump is OFF, the **⏻** Pump ON/OFF LED will be OFF. When the pump is ON, the **⏻** Pump ON/OFF LED will illuminate. Each time the pump strokes, the **⏻** Pump ON/OFF LED will flash OFF.

4.2 PUMP SPEED

The speed may be changed with the pump ON or OFF. To increase or decrease the speed, press or hold the **⬆** UP or **⬇** DOWN button. The range runs from 0 SPH to 120 SPM. While normally the speed will be set in SPM, if settings of SPH are desired, hold the **⬇** DOWN button until the display reads 1 SPM, then continue to hold it down. The display will then show SPH 59. The speed can be further reduced to 1 SPH with the **⬇** DOWN button.

4.3 PRIMING THE PUMP

The priming function allows a fixed-time prime period of 60 seconds and enables priming of the pump in any control mode. To begin priming, hold down the **⏻** POWER button for approximately 5 seconds. The pump will begin operating. Use the **⬆** UP and **⬇** DOWN buttons to vary the stroking speed. To stop priming before the priming cycle is complete, push the **⏻** POWER button. The pump will automatically stop after 60 seconds, and revert to the last used control mode.

Display Overview:

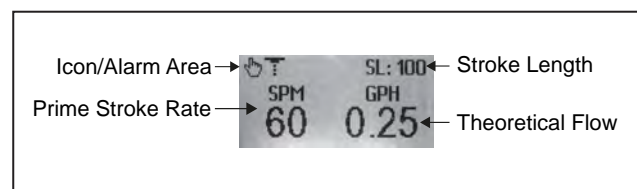

- 1. Icon/Alarm Area:** The **T** icon indicates the pump is in prime mode. Depending on advanced pump configuration options and any alarms alerts detected, other icons may be present as well (see Sec. 4.5).
- 2. Stroke Length:** The numeric stroke length value indicates the current stroke length setting (in percent).
- 3. Prime Stroke Rate:** Indicates the stroke speed of the pump while priming (1-120 SPM).
- 4. Theoretical Flow:** The theoretical flow based on stroke speed, stroke length, and calibration settings (see Sec. 6.6 for calibration information).

NOTE:



The prime stroke rate is independent of the current control mode stroke rate.



SECTION 4 - OPERATION OF THE SERIES AD9

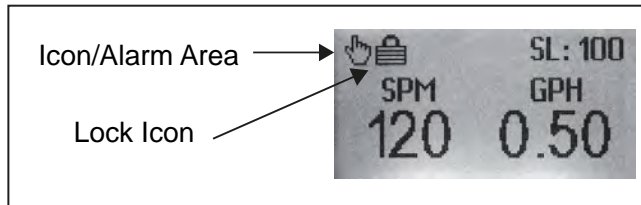

4.4 LOCKING/UNLOCKING THE PUMP

The pump has several lock modes to prevent casual tampering. For a complete description of the lock modes and how to configure them, see Sec. 6.4. A Lock Icon  in the Icon/Alarm Area indicates that the pump has been locked.



To activate the pump lock, depress the  DOWN and  MODE buttons simultaneously for about 1 second until the Lock Icon  appears in the Icon/Alarm area.

To unlock a locked pump, depress the  DOWN and  MODE buttons simultaneously for about 1 second until the Lock Icon  disappears in the Icon/Alarm area or until prompted for the unlock pass code (see below).

To enter the unlock pass code, use the  UP and  DOWN buttons to edit each digit. Use the  POWER button to advance to the next digit. If the pass code is incorrect, the pump will remain locked.

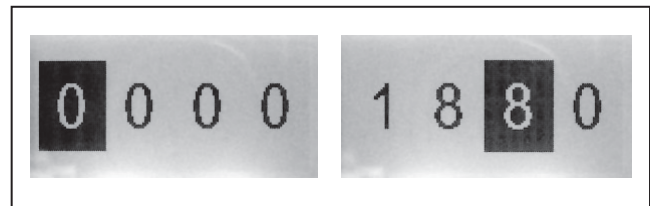

Example of entering an unlock pass code

NOTE:

Activating the pump lock is effective immediately. Do not activate unless you have made note of the unlock pass code, which is configured in Sec. 6.4. If the pass code is misplaced while the lock is active, the pump must be returned to the factory in order to be reset.

After approximately 2 minutes of inactivity, the unlock pass code display will close and revert back to the current control mode display.

4.5 ALARM/ICON AREA

The upper left portion of every Control Mode Display contains an icon/alarm notification area, which graphically displays operational information. If no alarm conditions exist, the display will only show configuration information. If one or multiple alarm conditions exist, the display will alternate every few seconds between showing configuration information and showing alarm information. Alarm information will always be preceded by the  icon.

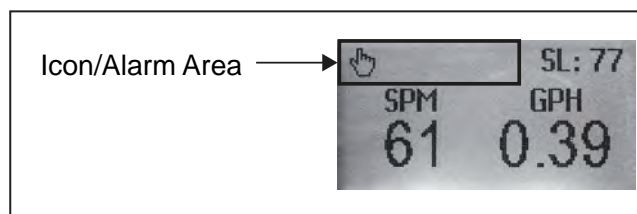

Configuration Icon Definitions:



















ICON	NAME	DESCRIPTION
	Manual Control Mode	Pump is in Manual Control Mode (See Sec. 5.1)
	Pulse Multiply Control Mode	Pump is in Pulse Multiply Control Mode (See Sec. 5.2)
	Pulse Divide Control Mode	Pump is in Pulse Divide Control Mode (See Sec. 5.3)
	Analog Control Mode	Pump is in Analog Control Mode (See Sec. 5.4)
	Timed Event Control Mode	Pump is in Timed Event Control Mode (See Sec. 5.5)
	Prime	The pump is priming (See Sec. 4.3)
	Keypad Locked	The keypad is locked (See Sec. 4.4)
	Digi-Pulse™ Flow Monitoring	Digi-Pulse™ flow switch monitoring is enabled (See Sec. 6.9)
	Percent-of-Time	Percent-of-Time Functionality Enabled (See Sec. 6.10)
	Batch Mode	Batch Mode Enabled (See Sec. 6.2)
	1-Point Calibration	Pump user-calibrated : 1-point (See Sec. 6.6.1)
	2-Point Calibration	Pump user-calibrated : 2-point (See Sec. 6.6.2)

Table1. Configuration Icon Definitions

SECTION 4 - OPERATION OF THE SERIES AD9

Alarm Icon Definitions:

ICON	NAME	DESCRIPTION
	Stroke length alarm	The pump is user-calibrated and the stroke length is operating outside the allowable range
	Digi-Pulse™ flow switch alarm **	Digi-Pulse™ Flow Monitoring is enabled and the missed strokes threshold has been reached
	Analog input alarm	The 4-20ma input current exceeds 21.5 mA
	Incoming pulse rate alarm	The input pulse rate results in a stroke rate exceeding 120 SPM
	Batch alarm	Pulses are received before current batch action is completed
	Low tank alarm	Corresponds to the external Tank Level Low input
	Empty tank alarm**	Corresponds to the external Tank Empty input

** = *The pump will stop stroking in this condition*

Table 2. Alarm Icon Definitions

SECTION 5 - CONTROL MODE SELECTION MENU

This menu is used to select the control mode or enter into the advanced configuration menu. There are 2 internal control modes and 3 external control modes. In order to operate the pump in an external control mode, a remote device must be connected to the pump through the 5-Pin connector.





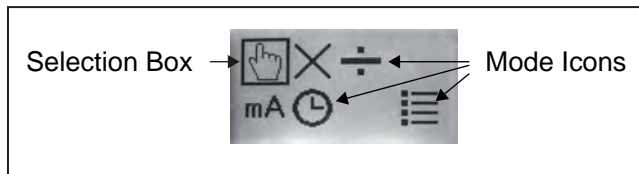

With the pump turned OFF, push the **MODE** button to bring up the Control Mode Selection Menu. Use the **UP** and **DOWN** buttons to scroll through the modes. Once the desired mode is selected, use the **POWER** button to enter that mode. Push and hold the **MODE** button for approximately 2 seconds to exit the menu.

Display Overview:



Control Mode Selection Menu

1. Mode Icons: Each icon represents a different control mode, as follows:

-  = Manual Mode - Internal (Sec. 5.1).
-  = Pulse Multiply Mode - External (Sec. 5.2).
-  = Pulse Divide Mode - External (Sec. 5.3).
-  = Analog mA Mode - External (Sec. 5.4).
-  = Timed Event Mode - Internal (Sec. 5.5).
-  = Advanced Configuration Options (Sec. 6.0).

2. Selection Box: Indicates the currently selected item.

NOTE:

After approximately 2 minutes of inactivity, the mode selection menu will automatically close and revert back to the prior display.

While in this menu, all external outputs will return to their default "OFF" state and all external inputs will be ignored.

5.1 MANUAL MODE (INTERNAL)

This mode is used when external devices are not being used to control the pump. While in manual mode, the stroke speed is varied by using the **UP** and **DOWN** buttons. To turn the pump ON or OFF, push the **POWER** button or toggle the remote ON/OFF. The **Pump ON/OFF LED** will illuminate green when the pump is ON.

Display Overview:

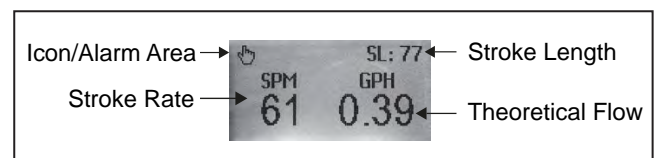

Manual Mode Display

- 1. Icon/Alarm Area:** The  icon indicates the pump is in the manual mode. Depending on advanced pump configuration options and any alarms alerts detected, other icons may be present as well (see Sec. 4.5).
- 2. Stroke Length:** The numeric stroke length value indicates the current stroke length setting (in percent).
- 3. Stroke Rate:** Indicates the stroke speed of the pump (1-59SPH or 1-120 SPM).
- 4. Theoretical Flow:** The theoretical flow based on stroke speed, stroke length, and calibration settings (see Sec. 6.6 for calibration information).

SECTION 5 - CONTROL MODE SELECTION MENU

5.2 PULSE MULTIPLY MODE (EXTERNAL)

This mode is used to control the pump with an external device connected to the appropriate contacts of the 5-Pin connector. With the pump OFF, use the **▲** UP and **▼** DOWN buttons to vary the strokes-per-pulse parameter. To turn the pump ON or OFF, push the **Ⓚ** POWER button, or toggle the remote ON/OFF. The **□** Pump ON/OFF LED will illuminate yellow when the pump is ON. With the pump turned ON, and a pulse is received, the pump will begin running, with the remaining pulses counting down on the display.

If a pulse is received before the countdown is complete and Batch Mode is OFF (see Sec. 6.2), the **⚠** error code (see Sec. 4.5) is displayed and the pump batch count then restarts from the strokes-per-pulse setpoint. The fault will be corrected when the pump completes the current batch OR the pump is stopped.

If a pulse is received before the countdown is complete and Batch Mode is ON (see Sec. 6.2), the pump will accumulate strokes (up to a maximum of 9999), allowing all strokes to be accounted for.

Display Overview:

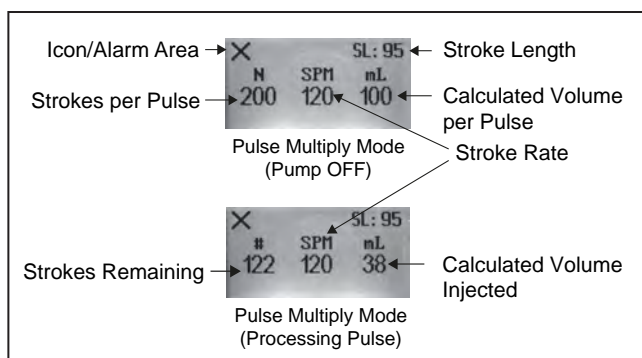

- Icon/Alarm Area:** The **×** icon indicates the pump is in the pulse multiply mode. Depending on advanced pump configuration options and any alarms/alerts detected, other icons may be present as well (see Sec. 4.5).
- Stroke Length:** The numeric stroke length value indicates the current stroke length setting (in percent).
- Stroke Rate:** Indicates the stroke speed of the pump (1-59 SPH or 1-120 SPM). To allow true flow proportioning, this is set in manual mode (see Sec. 5.1).
- Strokes per Pulse (Pump OFF only):** Number of strokes (1-9999) to occur for each valid pulse input. See Sec. 6.3 to define a valid pulse.
- Strokes Remaining (Pump ON only):** Number of strokes remaining for the current batch cycle.
- Calculated Volume per Pulse (Pump OFF only):** The calculated flow based on stroke count, stroke length, and calibration settings (see Sec. 6.6 for calibration information).
- Calculated Volume Injected (Pump ON only):** The calculated flow based on strokes made, stroke length, and calibration settings (see Sec. 6.6 for calibration information).

NOTE:

The pump will ignore the pulse input while the pump is OFF.

Depressing the **▲** UP and **▼** DOWN buttons simultaneously will cycle through alternate display formats, as shown below:

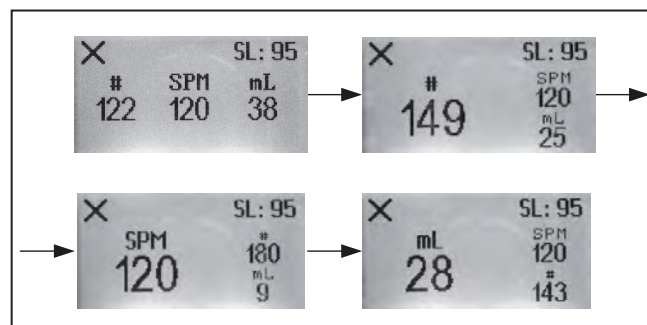

SECTION 5 - CONTROL MODE SELECTION MENU

5.3 PULSE DIVIDE MODE (EXTERNAL)

This mode is used to control the pump with an external device connected to the appropriate contacts of the 5-Pin connector. With the pump OFF, use the \blacktriangle UP and \blacktriangledown DOWN buttons to vary the pulses-per-stroke parameter. To turn the pump ON or OFF, push the Ⓚ POWER button or toggle the remote ON/OFF. The Ⓚ Pump ON/OFF LED will illuminate yellow when the pump is ON. With the pump turned ON, the pump will pulse after the programmed number of pulses has been received.

Display Overview:

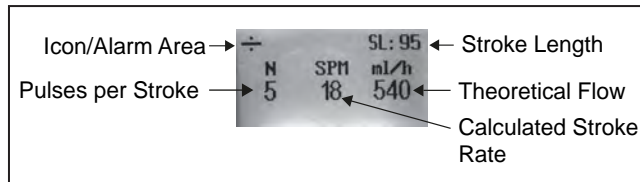

- 1. Icon/Alarm Area:** The \div icon indicates the pump is in the pulse divide mode. Depending on advanced pump configuration options and any alarms/alerts detected, other icons may be present as well (see Sec. 4.5).
- 2. Stroke Length:** The numeric stroke length value indicates the current stroke length setting (in percent).
- 3. Calculated Stroke Rate:** Indicates the calculated stroke rate of the pump (0-120 SPM) based on the rate of incoming pulses and the divide value.

4. Pulses per Stroke: Number (1-9999) of valid pulses to detect before performing a pump stroke. See Sec. 6.3 to define a valid pulse.

5. Theoretical Flow: The theoretical flow based on stroke speed, stroke length, and calibration settings (see Sec. 6.6 for calibration information).

NOTE:

The pump will display the calculated stroke rate and theoretical flow with the pump ON and OFF.

A $\text{>}}\text{]]}$ fault will be indicated if the calculated stroke rate exceeds 120 SPM (see Sec. 4.5).

Depressing the \blacktriangledown UP and \blacktriangle DOWN buttons simultaneously will cycle through alternate display formats, as shown below:

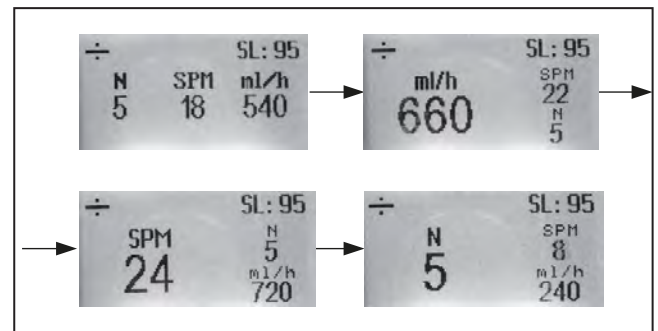

SECTION 5 - CONTROL MODE SELECTION MENU

5.4 ANALOG MODE (EXTERNAL)

This mode is used to control the pump with an external device connected to the appropriate contacts of the 5-Pin connector. With the pump OFF, press the ▲ UP or ▼ DOWN button to change the response curve (see Sec. 5.4.1). To manually turn the pump ON or OFF, push the Ⓚ POWER button or toggle the remote ON/OFF. The □ Pump ON/OFF LED will illuminate yellow when the pump is ON.

Display Overview:

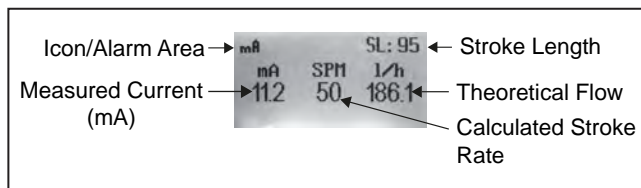

- 1. Icon/Alarm Area:** The mA icon indicates the pump is in the analog mode. Depending on advanced pump configuration options and any alarms/alerts detected, other icons may be present as well (see Sec. 4.5).
- 2. Stroke Length:** The numeric stroke length value indicates the current stroke length setting (in percent).
- 3. Calculated Stroke Rate:** Indicates the calculated stroke speed of the pump (0-59 SPH, 0-120 SPM) based on the analog set points and measured current.

- 4. Measured Current:** Measured current value (0-24.0 mA).
- 5. Theoretical Flow:** The theoretical flow based on calculated stroke speed, stroke length, and calibration settings (see Sec. 6.6 for calibration information).

NOTE:

The pump will display the calculated stroke rate and theoretical flow with the pump ON and OFF.

A >mA fault (see Sec. 4.5) will be indicated if the 4-20mA input exceeds 21.5mA.

The pump will not stroke if the 4-20ma input signal is 0.5mA or less.

Depressing the ▲ UP and ▼ DOWN buttons simultaneously will cycle through alternate display formats, as shown below:

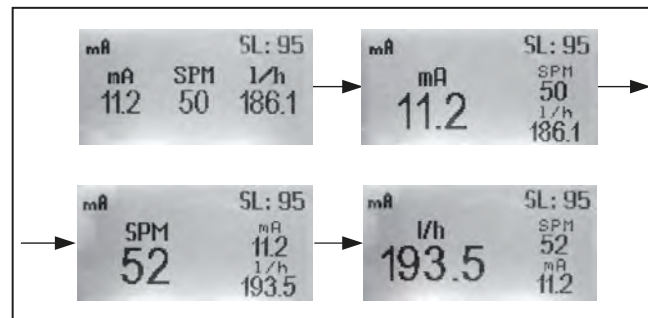

SECTION 5 - CONTROL MODE SELECTION MENU

5.4.1 Programming the Analog Mode Response Curve

Use the \blacktriangle UP or \blacktriangledown DOWN button to move the selection box to the parameter you wish to change. Use the Ⓚ POWER button to toggle to the parameter's edit mode - a black background indicates the parameter is in edit mode. While in edit mode, use the \blacktriangle UP and \blacktriangledown DOWN buttons to set the value. Use the Ⓚ POWER button to exit edit mode and save the setting.

<table border="1"> <thead> <tr> <th></th> <th>mA</th> <th>SPM</th> </tr> </thead> <tbody> <tr> <td>P1</td> <td>4.0</td> <td>0</td> </tr> <tr> <td>P2</td> <td>20.0</td> <td>120</td> </tr> </tbody> </table> <p>Parameter Selected</p>		mA	SPM	P1	4.0	0	P2	20.0	120	<table border="1"> <thead> <tr> <th></th> <th>mA</th> <th>SPM</th> </tr> </thead> <tbody> <tr> <td>P1</td> <td>4.0</td> <td>0</td> </tr> <tr> <td>P2</td> <td>20.0</td> <td>120</td> </tr> </tbody> </table> <p>Placed Into Edit Mode</p>		mA	SPM	P1	4.0	0	P2	20.0	120
	mA	SPM																	
P1	4.0	0																	
P2	20.0	120																	
	mA	SPM																	
P1	4.0	0																	
P2	20.0	120																	
<table border="1"> <thead> <tr> <th></th> <th>mA</th> <th>SPM</th> </tr> </thead> <tbody> <tr> <td>P1</td> <td>4.0</td> <td>0</td> </tr> <tr> <td>P2</td> <td>20.0</td> <td>110</td> </tr> </tbody> </table> <p>Parameter Modified</p>		mA	SPM	P1	4.0	0	P2	20.0	110	<table border="1"> <thead> <tr> <th></th> <th>mA</th> <th>SPM</th> </tr> </thead> <tbody> <tr> <td>P1</td> <td>4.0</td> <td>0</td> </tr> <tr> <td>P2</td> <td>20.0</td> <td>110</td> </tr> </tbody> </table> <p>Parameter Saved</p>		mA	SPM	P1	4.0	0	P2	20.0	110
	mA	SPM																	
P1	4.0	0																	
P2	20.0	110																	
	mA	SPM																	
P1	4.0	0																	
P2	20.0	110																	

Use either the Ⓚ MODE button or navigate using the \blacktriangle UP or \blacktriangledown DOWN buttons to exit the programming mode. The valid range for the mA value is 0.0 to 20.0 mA. The valid range for the SPM value is 0 to 120 SPM or 0-59 SPH.

The programming of points P1 and P2 when plotted will result in a graph similar to one of the 2 charts below (Pa = lowest programmed mA value; Pb = highest programmed mA value). The pump will vary its stroke speed linearly between points Pa and Pb based on the mA input signal. If the mA input signal exceeds Pb, the stroke speed will remain (plateau) at the speed corresponding to Pb. If the mA input drops to less than Pa, the stroke speed will remain (plateau) at the speed corresponding to Pa. Regardless of settings, if the mA input drops to 0.5 mA or below, the pump will stop stroking.

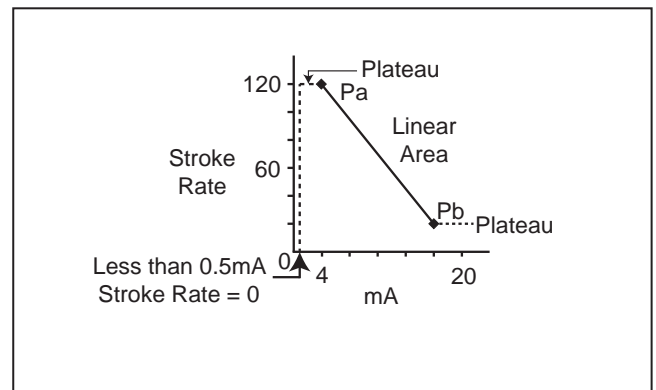
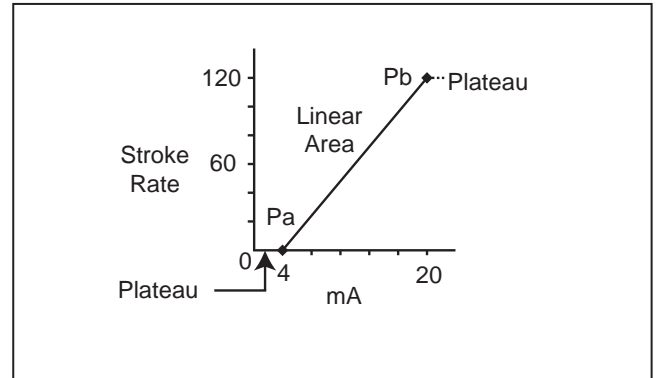

Display Overview:

	Selection Box	mA	SPM
Point 1 (P1) Settings	→ P1	4.0	0
Point 2 (P2) Settings	→ P2	20.0	120

- 1. Selection Box:** indicates the currently selected item.
- 2. Point 1 (P1) Settings:** the settings (mA and stroke rate) corresponding to set point P1.
- 3. Point 2 (P2) Settings:** the settings (mA and stroke rate) corresponding to set point P2.

NOTE :

Parameter changes are saved when editing is complete and go into effect immediately.

SECTION 5 - CONTROL MODE SELECTION MENU

5.5 TIMED EVENT MODE (INTERNAL)

With the pump OFF, press the \uparrow UP or \downarrow DOWN button to view and/or program the timed events (see Section. 5.5.1). To turn the pump ON or OFF, push the Ⓚ POWER button or toggle the remote ON/OFF. The Ⓚ Pump ON/OFF LED will illuminate green when the pump is ON.

Display Overview:

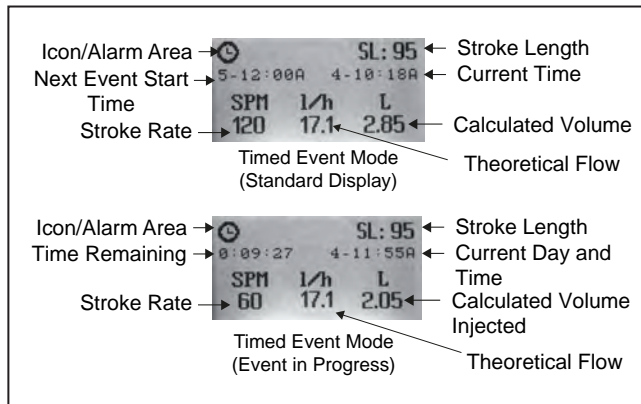

- 1. Icon/Alarm Area:** The Ⓚ icon indicates the pump is in the Timed Event mode. Depending on advanced pump configuration options and any alarms/alerts detected, other icons may be present as well (see Sec. 4.5).
- 2. Stroke Length:** The numeric stroke length value indicates the current stroke length setting (in percent).
- 3. Next Event Start Day and Time:** The Day and Time of the next timed event. See below for the displayed format. The '*' character in this field indicates that no events are enabled (see Sec. 5.5.1 for event programming information).

- 4. Current Day and Time:** The current Day and Time (see below for time format description).
- 5. Stroke Rate:** Indicates the stroke speed of the pump (1-59SPH or 1-120 SPM) for the currently running event or the next scheduled event.
- 6. Theoretical Flow:** The theoretical flow based on stroke speed, stroke length, and calibration settings (see Sec. 6.6 for calibration information).
- 7. Calculated Volume:** The calculated volume based on event duration, stroke rate, stroke length, and calibration settings (see Sec. 6.6 for calibration information).
- 8. Time Remaining (Event in Progress Only):** Remaining time of event.
- 9. Calculated Volume Injected (Event in Progress Only):** The calculated volume based on strokes made, stroke length, and calibration settings (see Sec. 6.6 for calibration information).

NOTE:

The displayed format for time is: D – H:MMx, where D = Day of Week (1-7), H = Hour (1-12), MM = Minute (0-59), x = A for AM or P for PM.

SECTION 5 - CONTROL MODE SELECTION MENU

5.5.1 Programming Timed Events

One timed event may be programmed to execute for each of 7 days. Each event has a uniquely programmable start time, duration, and stroke rate.

Use the \blacktriangle UP or \blacktriangledown DOWN button to move the selection box to the parameter you wish to change. Use the Ⓚ POWER button to toggle the parameter's edit mode. A black background indicates the parameter is in edit mode. The Event Enabled parameter will be toggled ON/OFF rather than going into an edit mode.

While in edit mode, use the \blacktriangle UP and \blacktriangledown DOWN buttons to set the value. The valid range for the day value is 1-7. As the day value is changed, the start time, duration, and stroke rate will be updated to reflect the programming for the selected day. A checked event enabled box indicates that the currently displayed event is enabled. The valid range for the duration value is 1 minute to 24 hours. The valid range for the SPM value is 0 to 120 SPM or 0-59 SPH.

Use the Ⓚ POWER button to exit the edit mode and save the setting. Use the Ⓜ MODE button to exit the programming mode.

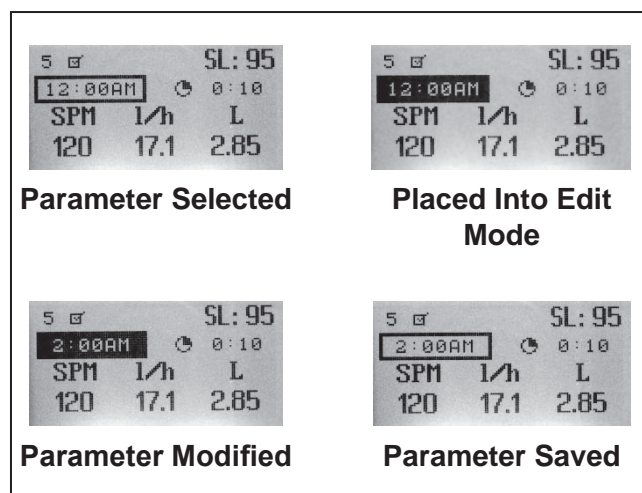

Display Overview:

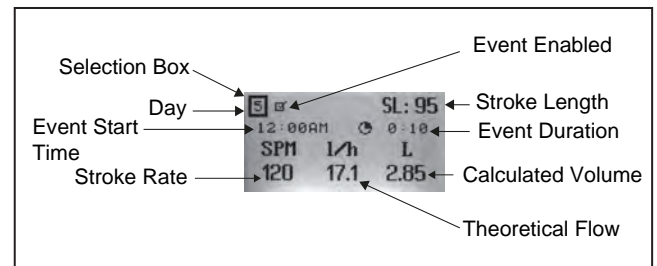

- 1. Selection Box:** Indicates the currently selected item.
- 2. Day:** Day of currently displayed event.
- 3. Event Enabled:** Indicates whether currently displayed event is enabled (checked = enabled).
- 4. Stroke Length:** The numeric stroke length value indicates the current stroke length setting (in percent).
- 5. Event Start Time:** The Day and Time of the next timed event (see Sec. 5.5 for time format).
- 6. Event Duration:** Duration / Run-Time of currently displayed event (format Hours:Minutes).
- 7. Stroke Rate:** Indicates the stroke speed of the pump (1-59SPH or 1-120 SPM) for the currently running event or the next scheduled event.
- 8. Theoretical Flow:** The theoretical flow based on stroke speed, stroke length, and calibration settings (see Sec. 6.6 for calibration information).
- 9. Calculated Volume:** The calculated based on event duration, stroke rate, stroke length, and calibration settings (see Sec. 6.6 for calibration information).

NOTE:

Parameter changes are saved when editing is complete and go into effect immediately.

After approximately 2 minutes of inactivity, the programming menu will automatically close and revert back to the main analog mode display.

SECTION 6 - ADVANCED CONFIGURATION MENU

Use the \blacktriangle UP and \blacktriangledown DOWN buttons to select the desired mode. Push and hold the $\text{\textcircled{1}}$ POWER button for approximately 1 second to select the desired mode. Push and hold the $\text{\textcircled{M}}$ MODE button for approximately 2 seconds to exit the menu.

Display Overview:

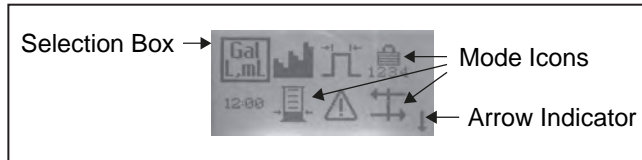

1. Mode Icons: Each icon represents a different control mode, as follows:

- = Set Units (Sec. 6.1)
- = Set Batch Mode (Sec. 6.2)
- = Set Pulse Width (Sec. 6.3)
- = Set Lock Mode Configuration (Sec. 6.4)
- = Set Clock (Sec. 6.5)
- = Calibrate Pump (Sec. 6.6)
- = Set Alarm / Internal-External Output (Sec. 6.7)
- = Set Remote Internal-External Mode Input (Sec. 6.8)
- = Digi-Pulse™ Setup (Sec. 6.9)
- = Set Percent-of-Time Operation (Sec. 6.10)
- = Load Factory Defaults (Sec. 6.11)
- = View Pump Information (Sec. 6.12)

2. Selection Box: Indicates the currently selected item.

3. Arrow Indicator: An arrow appearing on the upper or lower right of the display indicates that more icons are available via scrolling.

NOTE:

Parameter changes are saved when editing is complete and go into effect immediately.

After approximately 2 minutes of inactivity, the mode selection menu will automatically close and revert back to the most recent control mode display.

6.1 Gal L,mL SET UNITS

Use the \blacktriangle UP and \blacktriangledown DOWN buttons to select the desired units. Push the $\text{\textcircled{1}}$ POWER button to selected the item and return to the advanced configuration menu.

Display Overview:

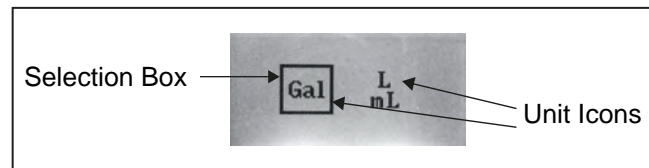





1. Unit Icons:

- Gal** = English Units
(i.e. Gallons per hour - GPH).
- L**
mL = Metric Units (i.e. Liters, milliliters).

2. Selection Box: Indicates the currently selected item.

SECTION 6 - ADVANCED CONFIGURATION MENU

6.2 SET BATCH MODE

Batch mode applies only to the Pulse Multiply Mode (see Section. 5.2). Use the  UP and  DOWN buttons to select On or Off. Push the  POWER button to select the item and return to the advanced configuration menu. Use the  MODE button to return to the advanced configuration menu without saving changes.

Display Overview:

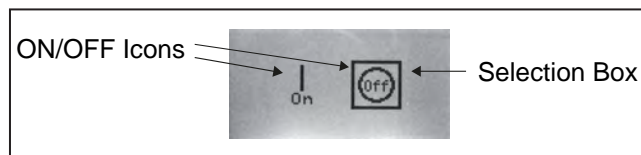





1. ON/OFF Icons:

 = Batch Mode ON (Stroke counter will accumulate when pulses are detected during an existing pump cycle)

 = Batch Mode OFF (Stroke counter will reset if a pulse is detected during an existing pump cycle)

2. **Selection Box:** Indicates the currently selected item.

6.3 SET PULSE WIDTH





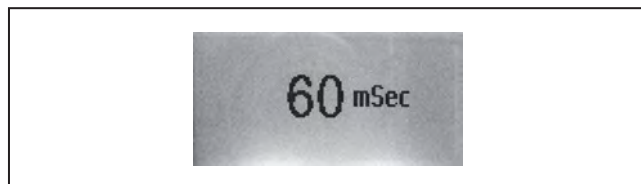

Use the  UP and  DOWN arrows to change the value for the pulse width. The valid range is 4 mSec - 60 mSec (in 4 mSec increments). Push the  POWER button to save the value and return to the advanced configuration menu. Use the  MODE button to return to the advanced configuration menu without saving changes.

Display Overview:



Pulse width (in milliseconds)

6.4 SET LOCK MODE CONFIGURATION

This menu is used to select the desired lock mode and to set the pass code; when you exit this menu, the lock is not activated (see Sec. 4.4 to activate the lock). Use the  UP or  DOWN button to select the desired parameter. Use the  POWER button to toggle to parameter's edit mode. A black background indicates the parameter is in edit mode. While in edit mode, use the  UP and  DOWN buttons to set the value. While setting the unlock pass code, use the POWER button to advance to the next digit, and the  MODE button to go back to the prior digit. Use the  MODE button to return to the advanced configuration menu.

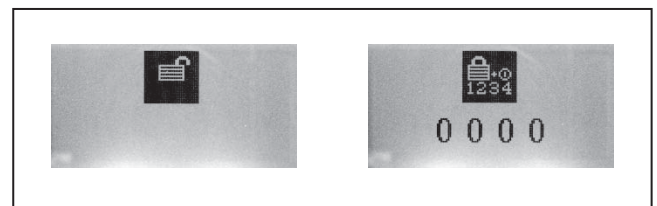

Example: Editing Lock Mode

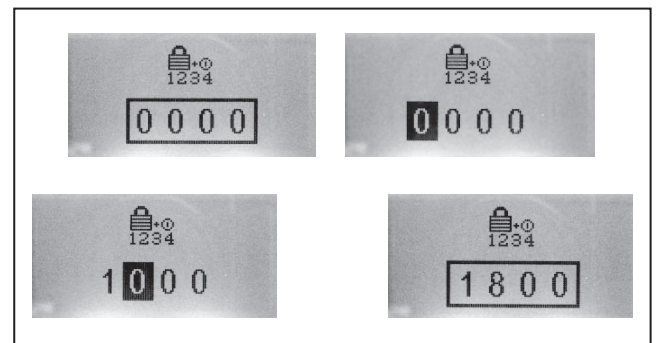

Example: Editing Unlock Pass Code

SECTION 6 - ADVANCED CONFIGURATION MENU

Display Overview:

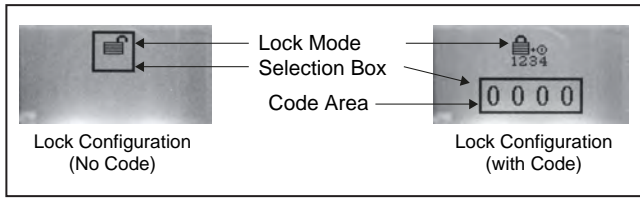

1. Lock Mode:

The icon corresponding to the current lock mode configuration.



= Always unlocked (default).



= All buttons locked out except the POWER button.



= All buttons locked out.



= All buttons locked out except the POWER button and an unlock pass code required to unlock pump.



= All buttons locked out and an unlock pass code required to unlock pump.

2. Code Area (on appropriate lock modes only):

Displays 4-digit unlock pass code.

3. Selection Box: Indicates the currently selected item.

NOTE:

Make note of the pass code you have selected. This will be required to unlock the pump. If the pass code is misplaced and the lock is activated, the pump must be returned to the factory in order to be reset (see Section 4.4 to unlock the pump).

6.5 12:00 SET CLOCK

The clock will only be displayed when operating in Timed Event Mode (see Sec. 5.5). Use the UP or DOWN button to edit the highlighted parameter. Use the POWER button to advance to the next parameter. Use the MODE button to go back to the prior parameter.

Display Overview:

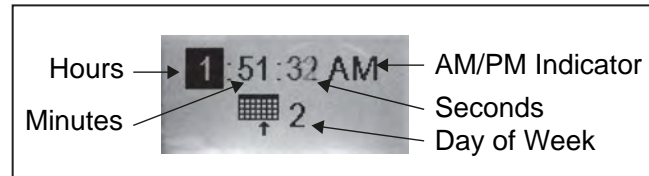



1. Hours (1-12).
2. Minutes (0-59).
3. Seconds (0-59).
4. AM/PM Indicator (AM or PM).
5. Day of Week (1-7).

6.6 PUMP CALIBRATION

Pump calibration will increase the accuracy of the various displayed flow rates and volumes. In Single-Point Calibration (see *first diagram below*), the pump is calibrated to a specific stroke length and flow rate (P1), changing the slope of the flow line as indicated in the diagram. The “Calibration Region” extends to +/- 10% of the calibrated stroke length. As a result, the Single-Point Calibration should only be used if the stroke-length is to be maintained within 10% of the calibration setting.

In Two-Point Calibration (see *second diagram below*), the pump is calibrated to two specific stroke length and flow rate combinations (Pa and Pb), changing the slope and the offset of the flow line as indicated in the diagram. Pa and Pb stroke lengths must differ by at least 10%. The “Calibration Region” extends from -10% of Pa to +10% of Pb stroke lengths. The Two-Point Calibration will always result in a larger “Calibration Region” than the Single-Point Calibration.

When a pump has been calibrated, the  or  icon is displayed in the Icon/Alarm area of the display (see Sec. 4.5). If the stroke length is adjusted outside the calibration region, the **SL** alarm icon will be displayed in the Icon/Alarm area of the display.

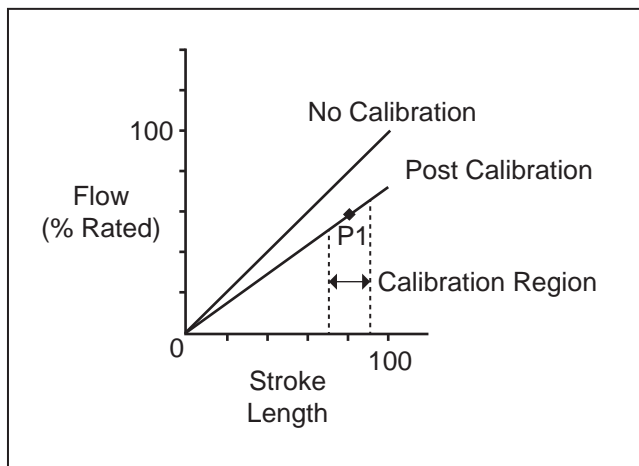

Figure 2. Single-Point Calibration

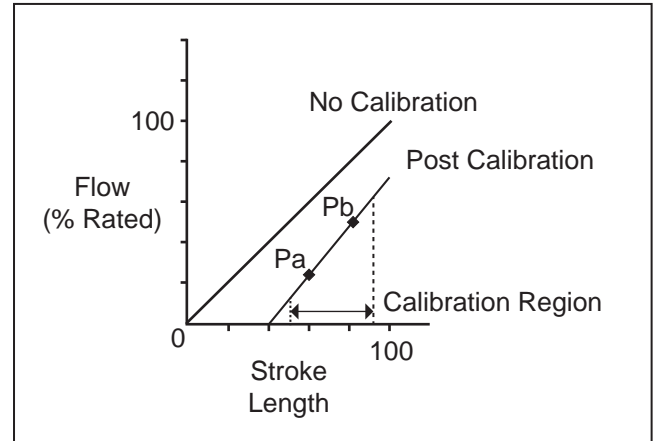



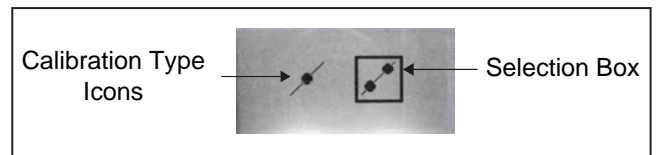



Figure 3. Two-Point Calibration

Use the  UP or  DOWN button to select the desired calibration mode. Use the  POWER button to select the mode (see Sec. 6.6.1 for *single-point calibration procedure* or Sec. 6.6.2 for *two-point calibration procedure*). Use the  MODE button to return to the advanced configuration menu without making changes.

Display Overview:



1. Calibration Type Icons: The icons corresponding to the following calibration types:

 = Single-Point Calibration

 = Two-Point Calibration

2. Selection Box: Indicates the currently selected item.

SECTION 6 - ADVANCED CONFIGURATION MENU

6.6.1 Single-Point Calibration Procedure

During calibration, accuracy improves as stroke count increases. As a result, a minimum of 100 strokes should be used to calibrate the pump. The maximum number of strokes in the calibration process is 9999. The stroke length cannot be changed during calibration step 3 below. If the stroke length is changed, a **SL** error icon will display, the pump will stop, and the stroke count and pump output will be reset to zero. Stroke speed may only be adjusted in step 2. In general, the **MODE** button may be used to step back in the calibration procedure.

Procedure:

1. Upon selecting single-point calibration, the **1** icon will be displayed indicating that pump is ready to begin calibration.

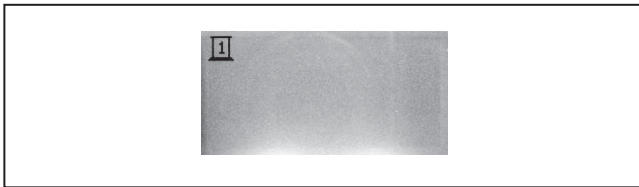

2. Press the **POWER** button. The pump will begin pulsing. Adjust the stroke length knob to the desired setting for calibration. Use the **UP** or **DOWN** buttons to adjust the stroke speed to the desired setting for calibration. Press the **POWER** button when adjustments are complete. The pump will stop pulsing.

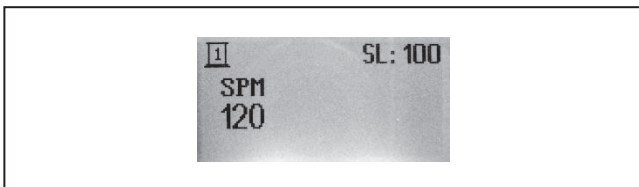

3. Press the **POWER** button to begin calibration of the pump. The pump will start pulsing. The display will begin counting the strokes and displaying the accumulated volume. The volume displayed is based upon the pre-existing settings. Press the **POWER** button when the desired number of strokes has occurred.

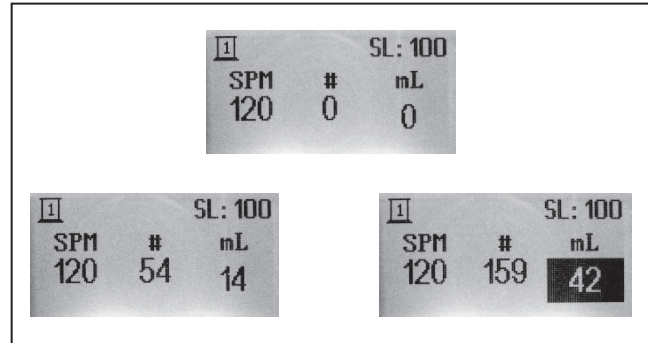

4. Use the **UP** or **DOWN** buttons to edit the highlighted volume as necessary. Press the **POWER** button when complete.

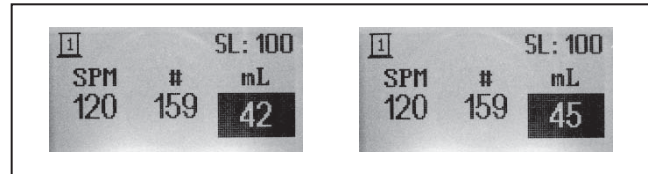

5. Use the **UP** or **DOWN** buttons to select whether to (Save) or (abandon) the displayed calibration settings. Press the **POWER** button to accept the selection and then return to the main calibration menu.

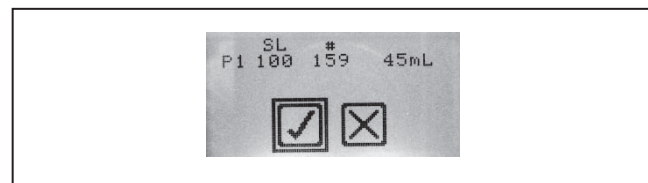

SECTION 6 - ADVANCED CONFIGURATION MENU

6.6.2 Two-Point Calibration Procedure

During calibration, accuracy improves as stroke count increases. As a result, a minimum of 100 strokes should be used to calibrate the pump. The maximum number of strokes in the calibration process is 9999. The stroke length cannot be changed during calibration steps 3 and 7. If the stroke length is changed, a **SL** error icon will display, the pump will stop, and the stroke count and pump output will be reset to zero. Stroke speed may only be adjusted in calibration steps 2 and 6. In general, the **MODE** button may be used to move back in the calibration procedure.

Procedure:

1. Upon selecting two-point calibration, the **1** icon will be displayed indicating that the pump is ready to begin calibration of point one.

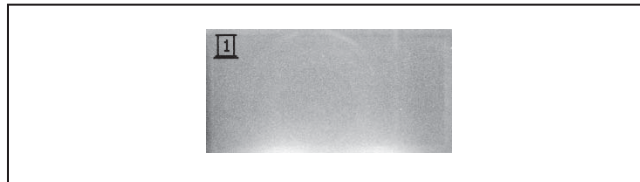

2. Press the **POWER** button. The pump will begin pulsing. Adjust the stroke length knob to the desired setting for calibration of point 1. Use the **UP** or **DOWN** buttons to adjust the stroke speed to the desired setting for calibration of point 1. Press the **POWER** button when adjustments are complete. The pump will stop pulsing.

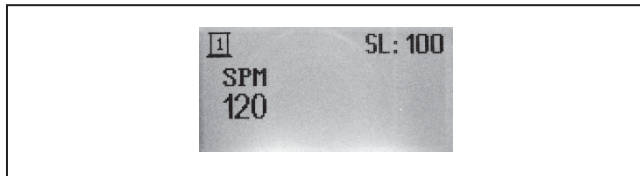

3. Press the **POWER** button to begin the calibration of point 1. The pump will start pulsing. The display will begin counting the strokes and displaying the accumulated volume. The volume displayed is based upon the pre-existing settings. Press the **POWER** button when the desired number of strokes has occurred.

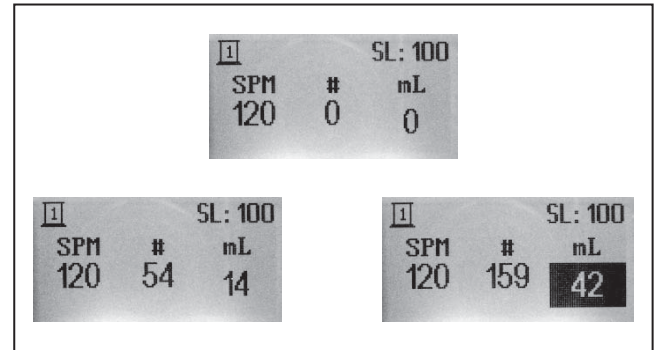

4. Use the **UP** or **DOWN** buttons to edit the highlighted volume as necessary. Press the **POWER** button when complete.

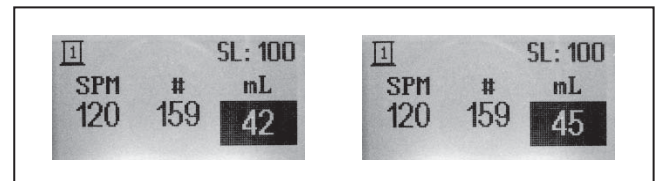

5. The **2** icon will now be displayed, indicating that the pump is ready to begin calibration of point two.

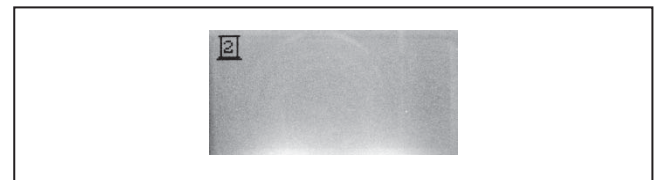

SECTION 6 - ADVANCED CONFIGURATION MENU

6. Press the **Ⓜ** POWER button. The pump will begin pulsing. Adjust the stroke length knob to the desired setting for calibration of point 2. Use the **⬆** UP or **⬇** DOWN buttons to adjust the stroke speed to the desired setting for calibration of point 2. Press the **Ⓜ** POWER button when adjustments are complete. The pump will stop pulsing. The two stroke length settings must be at least 10% apart. If not, a <10 error icon will display.

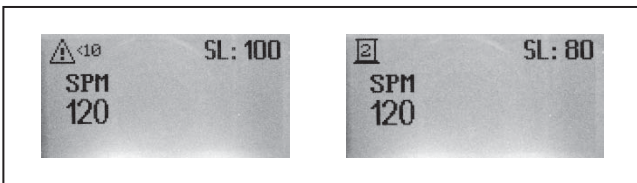

7. Press the **Ⓜ** POWER button to begin calibration of point 2. The pump will start pulsing. The display will begin counting the strokes and displaying the accumulated volume. The volume displayed is based upon the pre-existing settings. Press the **Ⓜ** POWER button when the desired number of strokes has occurred.

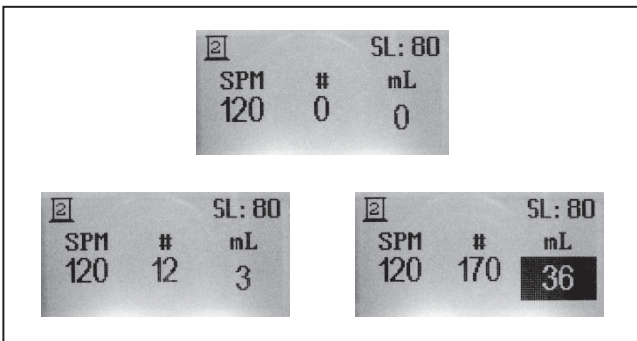

8. Use the **⬆** UP or **⬇** DOWN buttons to edit the highlighted volume as necessary. Press the **Ⓜ** POWER button when complete.

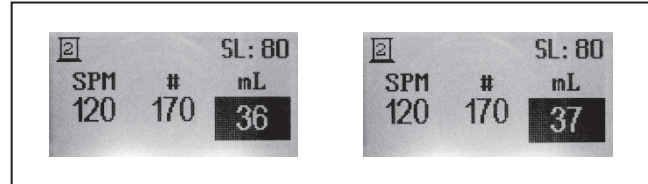



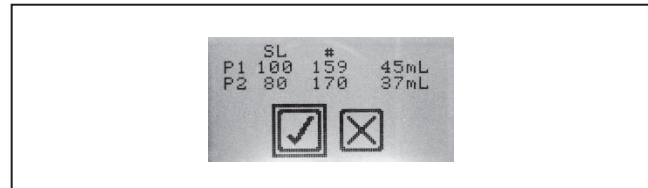

9. Use the **⬆** UP or **⬇** DOWN buttons to select whether to (Save) or (abandon) the displayed calibration settings. Press the **Ⓜ** POWER button to accept the selection and then return to the main calibration menu.



SECTION 6 - ADVANCED CONFIGURATION MENU

6.7 CONFIGURE ALARM OUTPUT

This feature is used to configure the alarm output, which is indicated on the appropriate contacts of the 6-Pin connector. The alarm output can be configured in one of two ways: it can be used to indicate the alarm status or it can be used to indicate whether the pump is in an internal or external control mode. If the alarm output is configured to indicate the alarm status, then open contacts indicate that there is no alarm. When an alarm is active, the contacts will be closed. If the alarm output is configured to indicate the internal external mode status, then open contacts indicates the pump is in an internal mode; closed contacts indicates the pump is in an external mode.

Use the  UP or  DOWN button to select the desired configuration. Use the  POWER button to select the configuration. If alarm output indicates alarm status is selected, the Alarm Output Mask configuration menu will display next (see Sec. 6.7.1). Use the  MODE button to return to the advanced configuration menu without making changes.

Display Overview:

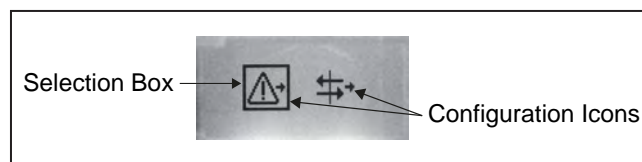







1. Configuration Icons:

 = Alarm output indicates alarm status.

 = Alarm output indicates Internal/External Mode status.

2. **Selection Box:** Indicates the currently selected item

6.7.1 Configure Alarm Output Mask

Use the  UP or  DOWN button to select the desired alarm to enable/disable. Use the  POWER button to toggle the associated status check box. Use either the  MODE button or navigate using the  UP or  DOWN buttons to save the data and return to the configure alarm output menu.

Display Overview:

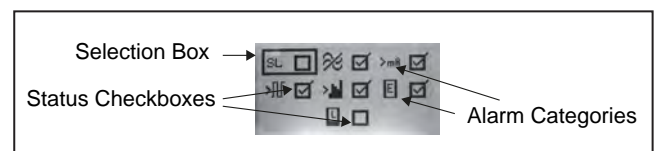

1. **Alarm Categories** (see Sec. 4.5 for descriptions of each alarm condition)

SL = Stroke length alarm.

 = DIGI-PULSE™ flow switch alarm.

>mf = Analog input alarm.

 = Incoming pulse rate alarm.

 = Batch alarm.

 = Empty tank alarm.

 = Low tank alarm.

2. **Status Check boxes:** Indicates if the alarm output will be enabled (checked) or ignored (unchecked) when the associated alarm condition is detected.

3. **Selection Box:** Indicates the currently selected item.





SECTION 6 - ADVANCED CONFIGURATION MENU

6.8 SET REMOTE INTERNAL-EXTERNAL MODE INPUT

This feature is used to switch from an internal control mode to an external control mode remotely by using the appropriate contacts of the 6-Pin connector. There are two internal control modes and 3 external control modes (see Sec. 5.0). The remote internal/external inputs are only monitored when the contacts are switched from open to closed, or vice versa. As a result, the control mode can always be changed from the pump, regardless of the closure status of these contacts.

If the pump is in an internal mode and the contacts on the remote internal/external input are closed, the pump will switch to the programmed external mode. If the pump is in an external mode and the contacts are opened, the pump will switch to the programmed internal mode.

If the pump is in an internal mode and the contacts are opened, no action will be taken—the pump will remain in the pre-existing control mode. In this case, if the pre-existing control mode differs from the programmed control mode, the pre-existing control mode takes priority. Conversely, if the pump is in an external mode and the contacts are closed, no action will be taken.

Use the  POWER button to toggle to parameter's edit mode. A black background indicates the parameter is in edit mode. While in edit mode, use the  UP and  DOWN buttons to set the value. Use the POWER button to exit edit mode and save the setting. Use the  MODE button to return to the advanced configuration menu.

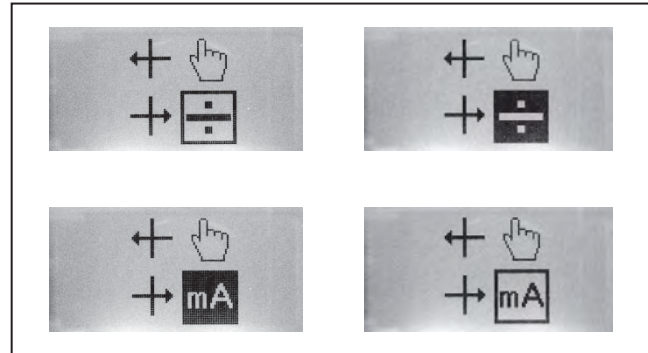

Example: Editing the External Control Mode Parameter

Display Overview:

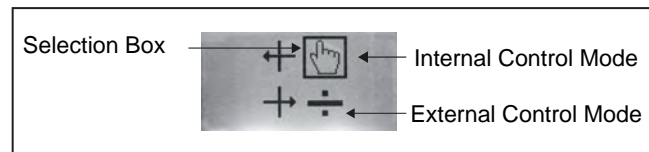

1. Internal Control Mode: The following are valid internal type control modes:

 = Manual

 = Timed Event

2. External Control Mode: The following are valid external type control modes:

 = Pulse Multiply







 = Pulse Divide

 = Analog (mA)

3. Selection Box: Indicates the currently selected item.

6.9 DIGI-PULSE™ FLOW MONITORING SETUP

This feature is used in conjunction with the LMI® Series FM-ROY-9 Digi-Pulse™ Flow Monitor (refer to DIGI-PULSE™ Flow Monitor Instructions P/N 1865). This device is designed to monitor the output flow from a pump. It may be set to deliver a pulse signal output for each successful pump stroke registered. If the flow stops or lessens, the pulse outputs will cease. With the FMROY- 9 connected to the 4-Pin connector, the presence or lack of pulses can be detected.

Use the  UP or  DOWN button to select the icon. Use the  POWER button to toggle the Function Enabled Indicator. Use the  POWER button to toggle the Missing Pulses parameter's edit mode. While in edit mode, use the  UP and  DOWN buttons to set the value. Use the  MODE button to return to the advanced configuration menu.

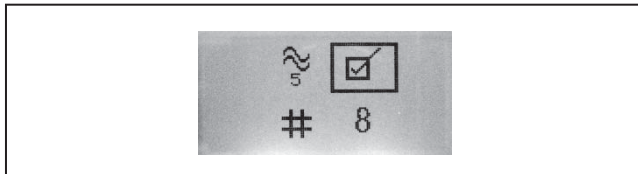

Example: Enabling the Function

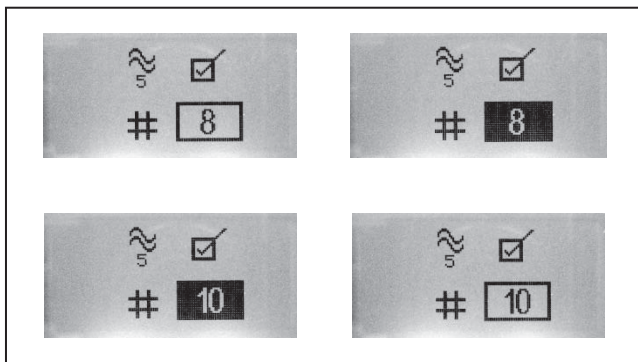

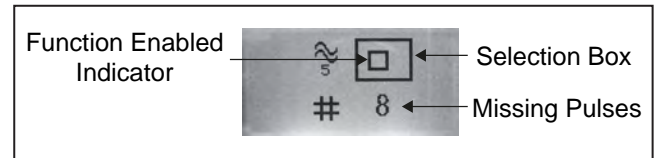

Example: Editing the Missing Pulses Parameter

Display Overview:



- 1. Function Enabled Indicator:** Check box indicating if DIGI-PULSE™ Flow Monitoring functionality is enabled (checked=enabled).
- 2. Missing Pulses:** Number of missing pulses to detect before issuing pump alarm. The valid range is 0-255. The factory default is 8. A setting of 1 is the most sensitive; a setting of 255 is the least sensitive.
- 3. Selection Box:** Indicates the currently selected item.

When flow monitoring is enabled, the  icon is displayed in the Icon/Alarm area of the display (see Sec. 4.5). If, for example, the Missing Pulses parameter is set to 5 and 5 strokes of the pump occur without any pulse being received from the FM-ROY-9, the  alarm icon will be displayed in the Alarm/Icon area of the display (see Sec. 4.5). The pump will stop and the alarm outputs will be activated, if enabled (see Sec. 6.7). Pressing the  POWER button clears the alarm.

SECTION 6 - ADVANCED CONFIGURATION MENU

6.10 % SET PERCENT-OF-TIME OPERATION

This feature allows time-based cycling of the pump in Manual, Pulse Divide, and Analog Control Modes. The pump cycles on and off based on the configuration parameters. Use the \blacktriangle UP or \blacktriangledown DOWN button to select the % icon. Use the Ⓚ POWER button to toggle the Function Enabled Indicator. Use the Ⓚ POWER button to toggle the parameter's edit mode (Percent of Time and Cycle Duration parameters). While in edit mode, use the \blacktriangle UP and \blacktriangledown DOWN buttons to set the value. Use the Ⓚ MODE button to return to the advanced configuration menu.

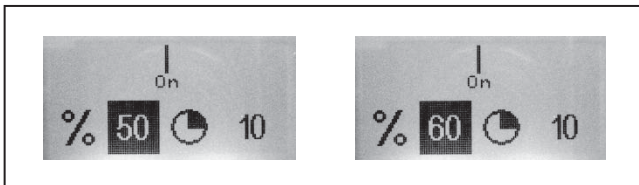

Example: Editing Percent-of-Time Parameter

Display Overview:

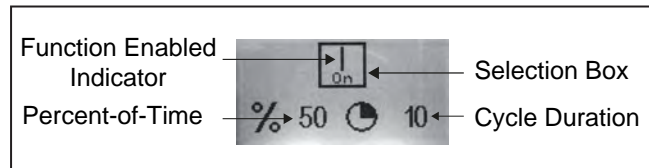

1. Function Enabled Indicator: Indicates if Percent-of-Time functionality is enabled.

Ⓚ = Function OFF / Disabled.

Ⓚ = Function ON / Enabled.

2. Percent of Time (Function ON only): Percent of time cycle to enable pump stroking (0-100).

3. Cycle Duration (Function ON only): Total cycle time in minutes (1-1440).

4. Selection Box: Indicates the currently selected item.

For example, if % = 20 and Ⓚ = 10, then the pump will cycle continuously as follows: run for 2 minutes, stop for 8 minutes. When this feature is enabled, the % icon is displayed in the Icon/Alarm area of the display (see Sec. 4.5).

SECTION 6 - ADVANCED CONFIGURATION MENU

6.11 ↻ LOAD FACTORY DEFAULTS

This feature will return the pump parameters to their factory default settings. Push the **ⓘ** POWER button to highlight the confirmation box. Push the **▲** UP or **▼** DOWN button to check or uncheck the box. Push the **ⓘ** POWER button to load factory defaults and return pump to default state (see Sec. 4.0). Use the **Ⓜ** MODE button to return to the advanced configuration menu without saving changes.

Display Overview:

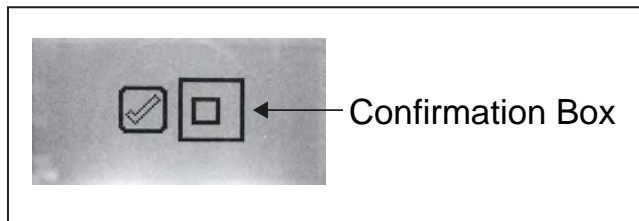

1. **Confirmation Box:** Check this box to confirm operation

6.12 ⓘ VIEW PUMP INFORMATION

This feature displays the pump firmware version. Use the **Ⓜ** MODE button to return to the advanced configuration menu.

Display Overview:

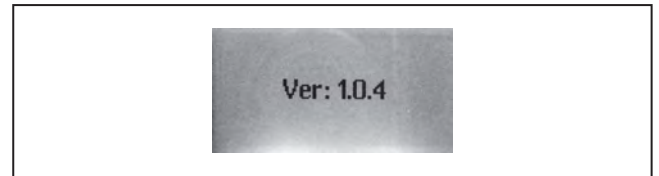

We are a proud member of Accudyne Industries, a leading global provider of precision-engineered, process-critical, and technologically advanced flow control systems and industrial compressors. Delivering consistently high levels of performance, we enable customers in the most important industries and harshest environments around the world to accomplish their missions.



**FOR SALES AND SUPPORT CALL
TOLL FREE 877-742-2878**

Return to BurtProcess.com

LMI® is a registered trademark of Milton Roy, LLC.
ROYTRONIC EXCEL™ is a trademark of Milton Roy, LLC.
DIGI-PULSE™ is a trademark of Milton Roy, LLC.
© 2015, 2011 Milton Roy, LLC.

info@lmipumps.com
www.lmipumps.com

