

FLEX-PRO[®]

Peristaltic Metering Pump



SERIES A3F and A4F

Operating Manual

Exclusive:

TFD system
Tube Failure Detection

Patent No. 7,001,153 & 7,284,964



ProSeries[®]
by Blue-White Ind.

Protected by Patents: 7,001,153;
7,284,964; 4,496,295
and other patents pending

5300 Business Drive, Huntington Beach, CA 92649 USA

Phone: 714-893-8529 FAX: 714-894-9492

E mail: sales@blue-white.com or techsupport@blue-white.com URL: www.blue-white.com

TABLE OF CONTENTS

<u>Section</u>	<u>Heading</u>	<u>Page</u>
1.0	Introduction	2
1.1	Available Models	3
2.0	Specifications	4
2.1	Materials of Construction	4
3.0	Features	5
3.1	Agency Listings	5
4.0	Installation.	6
4.1	Mounting Location	6
4.2	Dimensions	6
4.3	Installing the Discharge Injection Fitting and Suction Strainer	7
5.0	Input Power Connections	8
5.1	Wiring Terminals and I/O Schematics	9
6.0	How to Operate Flex-Pro	10
7.0	Pump Output Speed Adjustment	11
8.0	Contact Closure Input.	11
9.0	Set FVS (flow verification system).	12
10.0	Pump Tube Timer	13
11.0	TFD (tube failure detection)	13
12.0	Alarm relay	13
13.0	Reverse Rotor Rotation	14
14.0	How To Maintain the Pump.	15
15.0	Tube Replacement.	16
16.0	Model A3 Replacement Parts List	18
17.0	Model A4 Replacement parts List	19
18.0	Tubing Data	20
18.1	Tube Life Estimates	20
18.2	Output Versus Fluid Viscosity	22

1.0 Introduction

Congratulations on purchasing the Flex-Pro variable speed Peristaltic Metering Pump. A peristaltic pump is a type of positive displacement pump used for pumping a variety of fluids.

Your Flex-Pro pump is pre-configured for the tubing that shipped with your metering pump. The tubing assembly has an Identification number printed for easy re-order.

Please Note: Your new pump has been pressure tested at the factory with clean water before shipping. You may notice trace amounts of clean water in the pre-installed tube assembly. This is part of our stringent quality assurance program at Blue-White Industries.

1.1 Available Models

Feed Rate			Max Speed	Max Pressure	Max Temperature	A3 Model Numbers		
Norprene® A3 Tube Pumps								
Meets FDA criteria for food Excellent chemical resistance CIP SIP								
GPH	LPH	ML/Min	RPM	PSI (bar)	F (C)	115V AC	230V AC	220V AC
.001 - 2.10	.003 - 7.8	.05 - 132	125	125 (8.6)	185 (85)	A3F24-*ND	A3F25-*ND	A3F26-*ND
.010 - 25.3	.038 - 96.0	.6 - 1596	125	125 (8.6)	185 (85)	A3F24-*NJ	A3F25-*NJ	A3F26-*NJ
.013 - 33.3	.050 - 126	.8 - 2100	125	125 (8.6)	185 (85)	A3F24-*NK	A3F25-*NK	A3F26-*NK
.013 - 33.3	.050 - 126	.8 - 2100	125	30 (2.1)	185 (85)	A3F24-*NKL	A3F25-*NKL	A3F26-*NKL
Flex-A-Prene® A3 Tube Pumps								
Meets FDA criteria for food Excellent chemical resistance Extra long tube life								
GPH	LPH	ML/MIN	RPM	PSI (bar)	F (C)	115V AC	230V AC	220V AC
.002 - 4.8	.007 - 18.0	.12 - 300	125	110 (7.6)	185 (85)	A3F24-*NEE	A3F25-*NEE	A3F26-*NEE
.008 - 19.0	.030 - 72.0	.48 - 1200	125	110 (7.6)	185 (85)	A3F24-*NGG	A3F25-*NGG	A3F26-*NGG
Norprene® Chemical A3 Tube Pumps								
Meets FDA criteria for food Superior chemical resistance								
GPH	LPH	ML/Min	RPM	PSI (bar)	F (C)	115V AC	230V AC	220V AC
.006 - 14.5	.022 - 55.1	.4 - 920	125	50 (3.4)	130 (54)	A3F24-*TH	A3F25-*TH	A3F26-*TH
.011 - 28.5	.043 - 108.0	.7 - 1800	125	50 (3.4)	130 (54)	A3F24-*TK	A3F25-*TK	A3F26-*TK
Tygothane® A3 Tube Pumps								
Meets FDA criteria for food Resistant to oils, greases and fuels								
GPH	LPH	ML/Min	RPM	PSI (bar)	F (C)	115V AC	230V AC	220V AC
.002 - 4.6	.007 - 17.4	.1 - 290	125	65 (4.5)	130 (54)	A3F24-*GE	A3F25-*GE	A3F26-*GE
.004 - 10.1	.015 - 38.4	.3 - 637	125	65 (4.5)	130 (54)	A3F24-*GG	A3F25-*GG	A3F26-*GG
.010 - 24.9	.038 - 94.2	.6 - 1570	125	65 (4.5)	130 (54)	A3F24-*GH	A3F25-*GH	A3F26-*GH
.011 - 28.5	.043 - 108.0	.7 - 1800	125	65 (4.5)	130 (54)	A3F24-*GK	A3F25-*GK	A3F26-*GK
Feed Rate			Max Speed	Max Pressure	Max Temperature	A4 Model Numbers		
Norprene® A4 Tube Pumps								
Meets FDA criteria for food Excellent chemical resistance CIP SIP								
GPH	LPH	ML/Min	RPM	PSI (bar)	F (C)	115V AC	230V AC	220V AC
.01 - 28.5	.04 - 108	.7 - 1800	125	125 (8.6)	185 (85)	A4F24-*NH	A4F25-*NH	A4F26-*NH
.02 - 44.4	.07 - 168	1.1 - 2800	125	100 (6.9)	185 (85)	A4F24-*NJ	A4F25-*NJ	A4F26-*NJ
.02 - 50.7	.08 - 192	1.3 - 3200	125	80 (5.5)	185 (85)	A4F24-*NK	A4F25-*NK	A4F26-*NK
.02 - 54.0	.09 - 204	1.4 - 3400	125	100 (6.9)	185 (85)	A4F24-*NHH	A4F25-*NHH	A4F26-*NHH
.04 - 100.0	.15 - 378	2.5 - 6300	125	50 (3.4)	185 (85)	A4F24-*NL	A4F25-*NL	A4F26-*NL
.06 - 158.5	.24 - 600	4.0 - 10000	125	30 (2.0)	185 (85)	A4F24-*NP	A4F25-*NP	A4F26-*NP
Norprene® A4 Low Pressure Tube Pumps								
Meets FDA criteria for food Excellent chemical resistance Extra long life at low pressures								
GPH	LPH	ML/Min	RPM	PSI (bar)	F (C)	115V AC	230V AC	220V AC
.02 - 50.7	.07 - 192	1.3 - 3200	125	30 (2.1)	185 (85)	A4F24-*NKL	A4F25-*NKL	A4F26-*NKL
.04 - 111	.17 - 420	2.8 - 7000	125	30 (2.1)	185 (85)	A4F24-*NKKL	A4F25-*NKKL	A4F26-*NKKL
Norprene® Chemical A4 Tube Pumps								
Meets FDA criteria for food Superior chemical resistance								
GPH	LPH	ML/Min	RPM	PSI (bar)	F (C)	115V AC	230V AC	220V AC
.01 - 20.6	.03 - 78	.5 - 1300	125	30 (2.1)	130 (54)	A4F24-*TH	A4F25-*TH	A4F26-*TH
.02 - 42.8	.06 - 162	1.1 - 2700	125	30 (2.1)	130 (54)	A4F24-*TK	A4F25-*TK	A4F26-*TK
.02 - 50.7	.08 - 192	1.3 - 3200	125	30 (2.1)	130 (54)	A4F24-*THH	A4F25-*THH	A4F26-*THH
Tygothane® A4 Tube Pumps								
Meets FDA criteria for food Resistant to oils, greases and fuels								
GPH	LPH	ML/Min	RPM	PSI (bar)	F (C)	115V AC	230V AC	220V AC
.01 - 39.6	.06 - 150	1.0 - 2500	125	65 (4.5)	130 (54)	A4F24-*GH	A4F25-*GH	A4F26-*GH
.02 - 55.5	.09 - 210	1.4 - 3500	125	65 (4.5)	130 (54)	A4F24-*GK	A4F25-*GK	A4F26-*GK
.04 - 100	.20 - 378	2.5 - 6300	125	65 (4.5)	130 (54)	A4F24-*GKK	A4F25-*GKK	A4F26-*GKK

- The Flex-Pro Pump's motor speed is linear over the entire 0.05% to 100% adjustment range.
- Output versus pressure is nearly linear in all models. Larger tubes exhibit greater losses.
- See the instruction manual for output versus viscosity curves.
- For optimum tube life, specify the pump to operate at the lowest possible RPM and pressure.
- Output based on testing with water at 72 F, 5 foot suction lift, atmospheric conditions at sea level.

- * Inlet/outlet connection type
- S = 3/8" OD x 1/4" ID tubing compression type connections (A3 models only)
- M = 1/2" male NPT (available on A3 & A4 models)
- B = 1/2" ID tubing barb type connections (A3 Flex-A-Prene® and A4 models only)
- C = 1/2" - 3/4" tri-clamp connections (A3 Flex-A-Prene® models only)
- Q = Quick Disconnect (A3 Flex-A-Prene® models only)

2.0 Specifications

Maximum working pressure (excluding pump tubes):

125 psig (8.6 bar)

Note: see individual pump tube assembly maximum pressure ratings.

Maximum Fluid temperature (excluding pump tubes):

3/8" OD x 1/4" ID tubing connections: 130° F (54° C)

M/NPT connections: 185° F (85° C)

Note: see individual pump tube assembly maximum temperature ratings.

Ambient Operating Temperature

14°F to 115°F (-10°C to 46°C)

Ambient Storage Temperature

-40°F to 158°F (-40°C to 70°C)

Operating Voltage:

A3 MODELS: 96 to 264VAC-50/60Hz, 220W

A4 MODELS: 96 to 264VAC-50/60Hz, 350W

Power Cord Options:

115V60Hz = NEMA 5/15 (USA)

230V60Hz = NEMA 6/15 (USA)

220V50Hz = CEE 7/VII (EU)

240V50Hz = AS 3112 (Australia/New Zealand)

Enclosure:

NEMA 4X (IP66), Polyester powder coated aluminum.

Maximum Overall Dimensions:

A3 models: 8-1/8"W x 10-3/4"H x 15-1/4"D (20.6W x 27.3H x 38.9D cm)

A4 models: 12-1/8"W x 14-1/4"H x 18-5/8"D (30.8W x 36.1H x 47.3D cm)

Approximate shipping wt:

A3 models: 33 lb. (15.0 Kg)

A4 models: 58 lb. (26.3 Kg)

2.1 Materials of construction

Wetted components:

Pump Tube Assembly (Model Specific - 2 provided):

Tubing: Norprene® or Norprene® Chemical or Tygothane®

Adapter fittings: .PVDF

Injection / Back-flow Check valve:

Body & insert: PVDF

Check Ball: Ceramic

Spring: Hastelloy C-276

Ball Seat O-ring: Viton® (optional EP)

Static Seal O-ring: Viton® (optional EP)

Duckbill anti-scale valve: Santoprene®

Ancillary Items provided

With "S" tubing type connections only:

Suction Tubing: 3/8" OD x 1/4" ID x 10' Clear PVC

Discharge Tubing: 3/8" OD x 1/4" ID x 10' Polyethylene (LLDPE)

Suction Strainer: Polypropylene

With "B" tubing and "M" M/NPT connections only:

Suction Strainer:

Body: PVDF

Check Ball: Ceramic

Ball Seat O-ring: Viton® (optional EP)

For "C" Tri-clamp and "Q" Quick Disconnect connections only:

(Available on A3 Flex-A-Prene® only)

Suction Strainer: Polypropylene

Motor speed adjustment range 2,500:1:

0.05% - 100% motor speed

Motor speed adjustment resolution:

0.1% increments > 10% motor speed

0.01% increments > 1% motor speed and < 10%

0.001% increments < 1% motor speed

Maximum viscosity:

12,000 Centipoise

Maximum suction lift:

30 ft. Water, 0 psig (4.5 m, 0 bar)

Display

3 color VGA backlit LCD, UV resistant.

Display Languages

English, Spanish, French or German selectable.

Keypad

Ten button positive action tactile switch keypad.

Security

Programmable 4-digit password.

Non-Wetted components:

Enclosure:

413 Aluminum (Polyester powder coated)

Pump Head:

Valox® (PBT) thermoplastic

Pump Head Cover:

Polycarbonate for added strength and chemical resistance.

Permanently lubricated sealed motor shaft support ball bearing.

Cover Screws:

Stainless Steel

Roller Assembly:

Rotor:Valox® (PBT)

Rollers:Nylon

Roller Bearings:SS Ball Bearings

Motor Shaft:

Chrome plated steel

TFD System Sensor pins:

Hastelloy C-276

Power Cord:

3 conductor, SJTW-A Water-resistant

Tube Installation Tool:

GF Nylon

Mounting Brackets and Hardware:

316 Stainless Steel

3.0 Features

- Peristaltic pump design does not have valves that can clog requiring maintenance.
- Self priming - even against maximum line pressure. By-pass valves are not required. Cannot vapor lock or lose prime. Syphoning cannot occur.
- Output rates to: 158.5 GPH (600 LPH) and pressures to 125 PSI (8.6 Bar).
- No maintenance brushless variable speed motor.
- Specially engineered tubing for long life at high pressures.
- Patented Tube Failure Detection (TFD) system. Senses tube failure by detecting chemical in the pump head. No false triggering.
- 2500:1 turndown ratio.
- Remote start/stop.
- Operator friendly digital touch pad.
- VGA Graphic multi-color backlit LCD displays remote/local control status, motor speed, output rate, service and alarm status.
- Outputs include one 250V/6A Form C no/nc relay assigned to monitor both the TFD, FVS systems.
- Two CNC precision machined squeeze rollers and two alignment rollers for optimum squeeze, unparalleled accuracy, and tube life.
- Heavy duty rotor - single piece plastic rotor means no flexing and increased accuracy (no metal springs or hinges to corrode).
- Inject at maximum PSI in either direction (clockwise and counter clockwise).
- Compatible with Blue-White's output Flow Verification Sensor (FVS) system.

Enclosure Rating:

NEMA 4X: Constructed for either indoor or outdoor use to provide a degree of protection to personnel against incidental contact with enclosed equipment; to provide a degree of protection against falling dirt, rain, sleet, snow, windblown dust, splashing water, and hose-directed water; and that will be undamaged by external formation of ice on enclosure.

IP66: No ingress of dust; complete protection against contact. Water projected in powerful jets against enclosure from any direction shall have no harmful effects.

3.1 Agency Listings





This pump is ETL listed to conform to the following:
 UL Standard 778 as a motor operated water pump
 CSA Standard C22.2 as process control equipment



This pump complies to the Machinery Directive 98/37/EC, BS EN 60204-1, Low Voltage Directive 73/23/EC BS EN 61010-1, EMC Directive 89/336/EC, BS EN 50081-1/BS EN 50082-1.

Symbol	Explanation
	WARNING, risk of electric shock
	CAUTION, refer to users' guide
	GROUND, PROTECTIVE CONDUCTOR TERMINAL

4.0 Installation

CAUTION 	Risk of chemical overdose. Be certain pump does not overdose chemical during backwash and periods of no flow in circulation system.
CAUTION 	Always wear protective clothing, face shield, safety glasses and gloves when working on or near your metering pump. Additional precautions should be taken depending on solution being pumped. Refer to MSDS precautions from your solution supplier.
CAUTION 	All diagrams are strictly for guideline purposes only. Always consult an expert before installing metering pump on specialized systems. Metering pump should be serviced by qualified persons only.

4.1 Mounting Location

Choose an area located near chemical supply tank, chemical injection point, and electrical supply. Install pump where it can be easily serviced.

- 316SS Mounting brackets are included. Mount pump to a secure surface using enclosed mounting hardware.
- Mount pump close to injection point. Keep inlet (suction) and outlet (discharge) tubing as short as possible. Longer discharge tubing increases back pressure at pump head.
- A back flow prevention check valve is recommended at the discharge of the pump to prevent system fluid from flowing back through the pump during tube replacement or if the tube should rupture.
- A pressure relief valve is recommended at the discharge of the pump to prevent premature wear and damage to the pump tube in the event the discharge line becomes blocked.
- The Flex-Pro does not require back pressure. Pressure regulator valves are not required. Keep the discharge pressure as low as possible to maximize tube life.
- An anti-syphon valve is not required. Syphoning cannot occur.

4.2 Dimensions

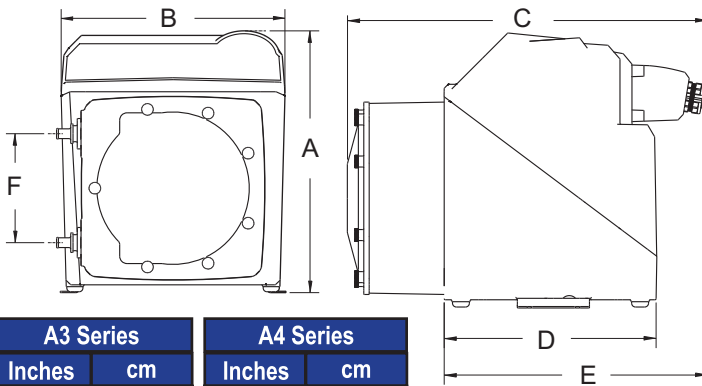

Dim	A3 Series		A4 Series	
	Inches	cm	Inches	cm
A	10-3/4"	27.3	14-1/4"	36.1
B	8-1/8"	20.6	12-1/8"	30.8
C	15-1/4"	38.9	18-5/8"	47.3
D	10"	25.4	11"	27.9
E	12-1/4"	31.0	13-5/8"	34.6
F	4-1/4"	10.7	6"	15.2

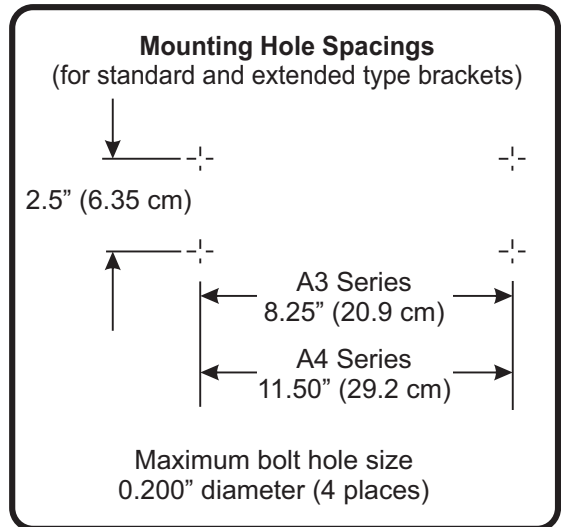

Optional Extended Brackets Model Number 72000-380

Stainless Steel extended brackets allow pump to be securely mounted to most any surface; floor, shelf, or skid. Brackets lift pump up 4-1/2 inches (11.43 cm), for easy pump access in hard to reach areas.

- Raise metering pump 4-1/2 inches (11.43 cm) off ground or a surface.
- Made out of tough Stainless Steel.
- Provides a stable mounting surface.

Model #	Description
72000-380	Extended Mounting Bracket, 1 Pair, SS, 4 SS Screws



4.3 Installing Discharge Injection Fitting and Suction Strainer

CAUTION Proper eye and skin protection must be worn when installing and servicing pump.

CAUTION This Pump Has Been Evaluated for Use with Water Only.

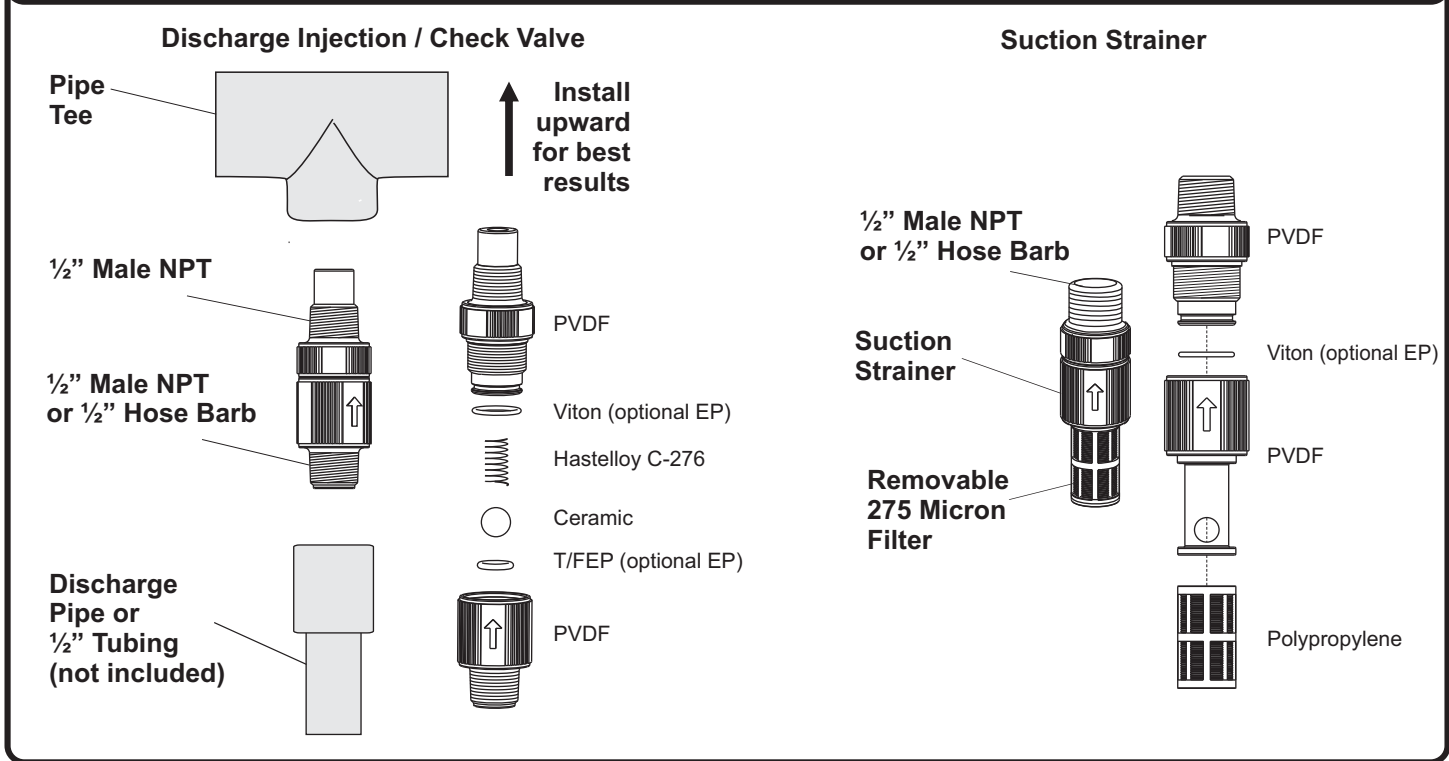

1/2" Male NPT Connection and 1/2" Hose Barb Models

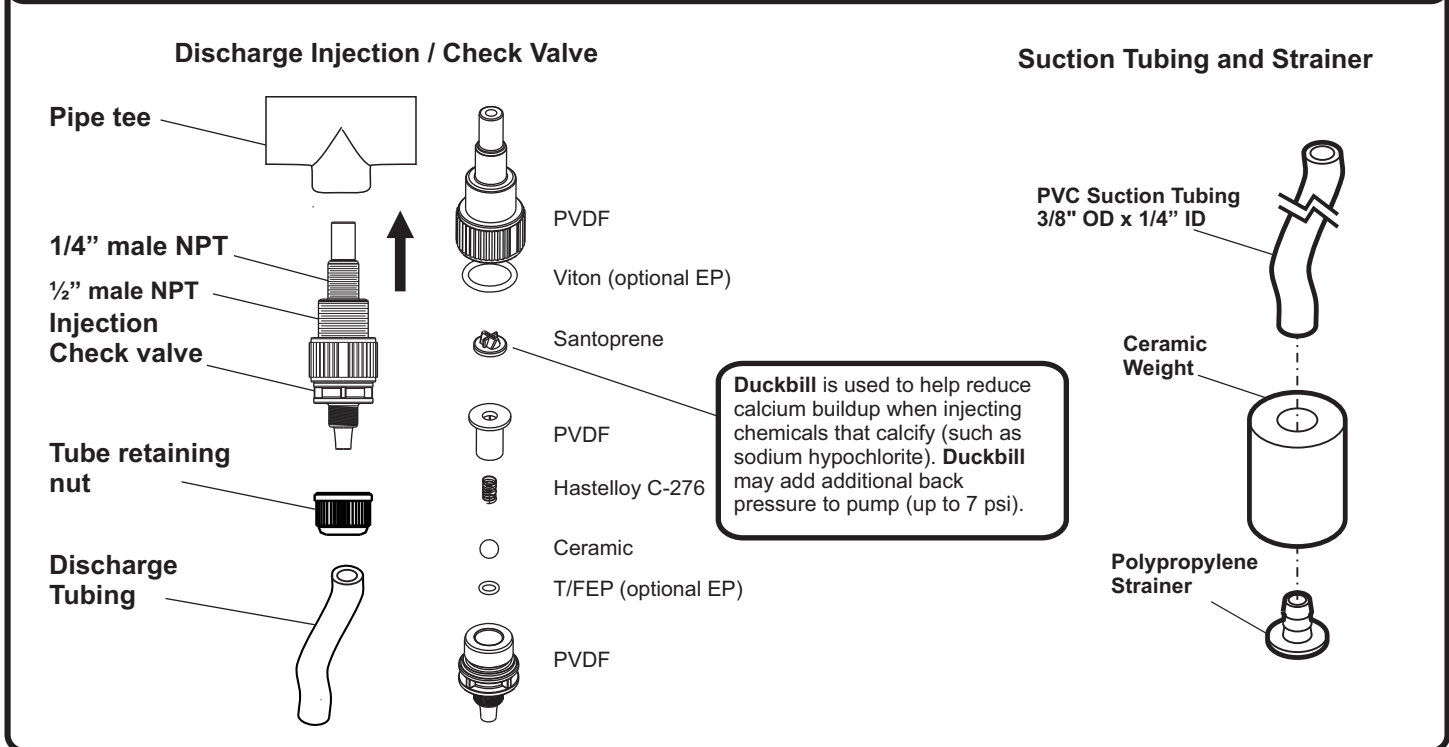

3/8" OD x 1/4" ID Tubing and Tri-Clamp connection Models



5.0 Input Power Connections

WARNING 	Risk of electric shock – cord connected models are supplied with a grounding conductor and grounding-type attachment plug. To reduce risk of electric shock, be certain that it is connected only to a properly grounded, grounding-type receptacle.
WARNING 	Electrical connections and grounding (earthing) must conform to local wiring codes. Be certain that a grounding conductor is connected to terminal T11-1 located in the wiring compartment.
WARNING 	Risk of electric shock - Disconnect electricity before removing the wiring compartment cover.

- Be certain to connect pump to proper supply voltage. Using incorrect voltage will damage pump and may result in injury. Voltage requirement is printed on pump serial label.
- Input power range is 96VAC to 264VAC 50/60 Hz.
- Voltage Selection is automatically detected and adjusted by power supply. No mechanical switch necessary.
- Use voltage your power cord is rated for.
- Cord connected models are supplied with a ground wire conductor and a grounding type attachment plug (power cord). To reduce risk of electric shock, be certain that power cord is connected only to a properly grounded, grounding type receptacle.
- Permanently connected models must be properly grounded. Be certain that a grounding conductor is connected to terminal T11-1 located in the wiring compartment.
- Never strap control (input / output) cables and power cables together.
- **Power Interruption:** This pump has an auto-restart feature which will restore pump to operating state it was in when power was lost.

Note: When in doubt regarding your electrical installation, contact a licensed electrician.

WIRING COMPARTMENT COVER

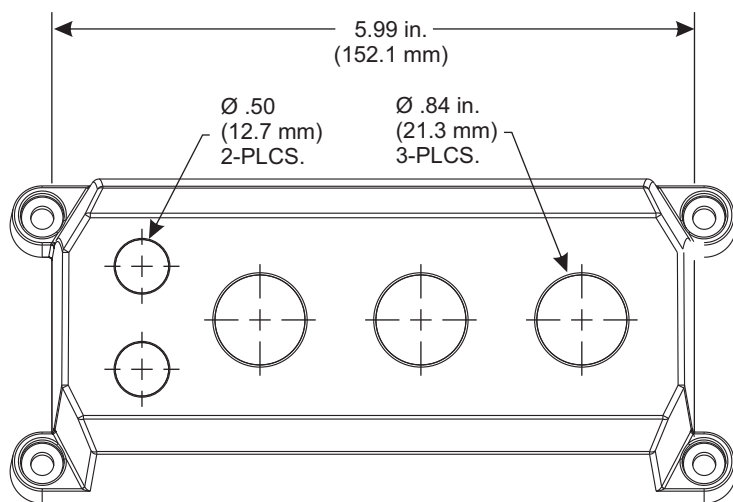

POWER CORD OPTIONS

Three power cord plug types available.
Power cord length is 6 feet (3.83 meters)



115V 60Hz
NEMA 5/15 (USA)
max: 125V AC

230V 60Hz
NEMA 6/15 (USA)
max: 250V AC

240V 50Hz
CEE 7/VII (EU)
max: 250V AC

Cable and conduit connectors included

QTY. DESCRIPTION

- | | |
|---|--|
| 2 | .50 INCH (12.7 mm) LIQ-TIGHT HOLE PLUGS (MAT'L = NEOPRENE), PRE-INSTALLED |
| 3 | .875 INCH (22.2 mm) LIQ-TIGHT HOLE PLUGS (MAT'L = NEOPRENE), 2 PRE-INSTALLED |
| 2 | .50 INCH (12.7 mm) LIQ-TIGHT CONNECTORS FOR PASS THRU CORDS (MAT'L = NYLON)
ACCEPTABLE CABLE DIAMETER .118 TO .255 INCH (3.0 TO 6.5 MM), NOT INSTALLED |
| 3 | .875 INCH (22.2 mm) METALLIC LIQ-TIGHT CONNECTORS FOR PASS THRU CORDS (MAT'L = NYLON)
ACCEPTABLE CABLE DIAMETER .200 TO .395 INCH (5.1 TO =10.0 MM), 1 PRE-INSTALLED WITH POWER CORD MODELS |
| 2 | METALLIC LIQ-TIGHT CONNECTORS FOR .50 INCH FLEXIBLE CONDUIT (MAT'L = DIE CAST ZINC), NOT INSTALLED |

5.1 Wiring Terminals and I/O Schematics

WARNING

Risk of electric shock - All wiring must be insulated and rated 300V minimum.

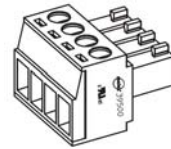
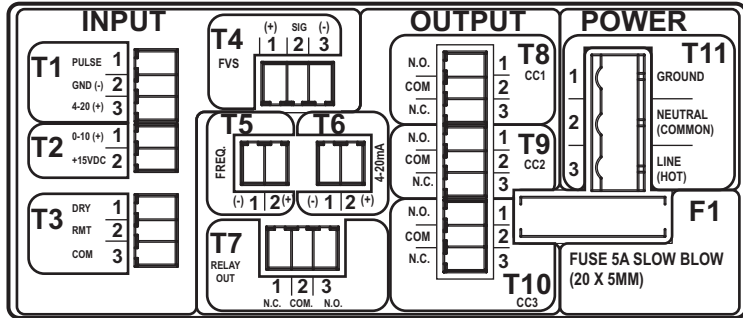

Terminals T1 thru T10
Plug type
16 - 24 AWG

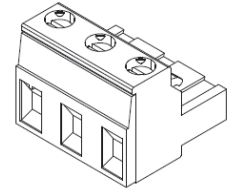

Power Input Terminal T11
Plug type
14 - 30 AWG

Shielded cables should be used on all input signal wires.

FUNCTION	TERMINAL	PIN #	RATING	ELECTRICAL SP.	
NOT USED	T1	3	(+) POSITIVE		
	T1	2	(-) NEGATIVE		
NOT USED	T1	1	(+) POSITIVE		
	T1	2	(-) NEGATIVE		
NOT USED	T2	1	(+) POSITIVE		
	T1	2	(-) NEGATIVE		
INPUT: FVS (FLOW VERIFICATION SENSOR)	T4	1	(+) POSITIVE		
	T4	2	SIGNAL		
	T4	3	(-) NEGATIVE		
INPUT: REMOTE START / STOP (DRY CONTACT C.)	T3	1	(-) NEGATIVE	NO VOLTAGE	
	T3	2	(+) POSITIVE		
INPUT: REMOTE START / STOP (WET CONTACT C.)	T3	2	(+) POSITIVE	6 TO 30 VOLT DC 1 AMP MAX.	
	T3	3	(-) NEGATIVE		
NOT USED	T6	2	(+) POSITIVE		<p>NOTE: USE ONLY DRY CONTACT FOR REMOTE S/S WHEN USING 4-20mA INPUT OR 0-10V DC</p>
	T6	1	(-) NEGATIVE		
NOT USED	T5	2	(+) POSITIVE		
	T5	1	(-) NEGATIVE		
OUTPUT: RELAY, 10 AMP	T7	1	NORM. CLOSED	6 AMP MAX AT 250 VAC, 5 AMP MAX AT 30 VOLT DC	
	T7	2	COMMON		
	T7	3	NORM. OPEN		
NOT USED	T8	1	NORM. OPEN		<p>SWITCH LOAD 10 AMP MAX @ 250V AC 8 AMP MAX @ 30V DC</p>
	T8	2	COMMON		
	T8	3	NORM. CLOSED		
NOT USED	T9	1	NORM. OPEN		
	T9	2	COMMON		
	T9	3	NORM. CLOSED		
NOT USED	T10	1	NORM. OPEN		
	T10	2	COMMON		
	T10	3	NORM. CLOSED		
INPUT: POWER	T11	1	GROUND	96 TO 264 VOLT AC, 50 / 60 HZ A3 = 220W A4 = 350W	
	T11	2	NEUTRAL		
	T11	3	LINE (HOT)		
FUSE	F1	NA	5 AMP	5A SLOW BLOW (20 X 5MM)	

6.0 How To Operate Flex-Pro

Flex-Pro F Series, Control Panel - Button Operation

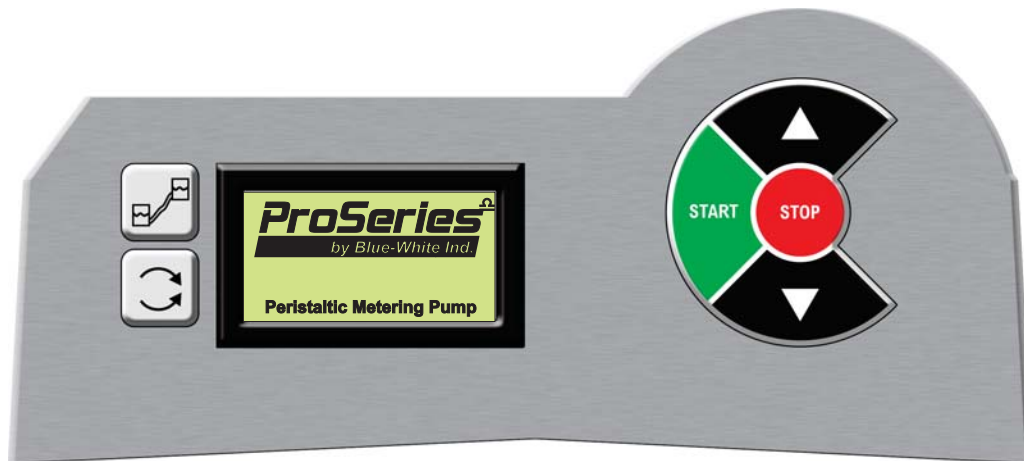

To STOP pump at any time

Pump can be stopped at any time by pressing STOP button. STOP button overrides all other controls and stops pump. Display will read OFF if pump has been stopped in this manner. Pump will not respond to incoming input signals while in OFF state. When START button is pressed, pump will start according to it's previous operating state.



To START pump

Press START button to start pump. If a remote start/stop input signal is used, the pump will begin "listening" for the input signal. Pressing the START button repeatedly will toggle the display to indicate the %SPEED, RPM, and Tube Timer Hours.

UP Arrow



Press UP arrow to increase pump output.
Press UP arrow to navigate through menu items.

DOWN Arrow



Press DOWN arrow to increase pump output.
Press DOWN arrow to navigate through menu items.



To PRIME pump

Press PRIME button to start 60 second prime feature. Pump will run at full speed for 60 seconds or until STOP or START button is pressed. STOP button will stop pump and display will read OFF. START button will stop prime feature and jump back into previous operating state.



To REVERSE ROTATION of rotor

Press REVERSE ROTATION button to reverse flow. A3V pump display will guide you through reverse rotor rotation process.

7.0 Pump Output Speed Adjustment

Press UP arrow to increase pump output. Press DOWN arrow to increase pump output.

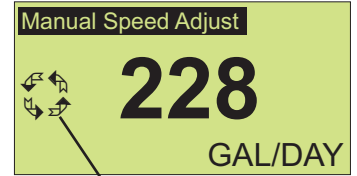

Displays current rotor direction

Tip! Pressing the START button repeatedly will toggle the display to indicate the %SPEED, RPM, and Tube Timer Hours.

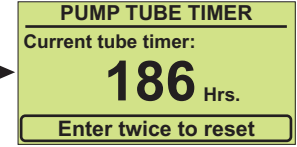
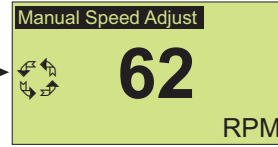
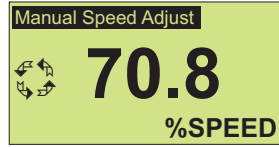

Tube Timer Displays for 4 seconds.

8.0 Contact Closure Input (Remote Start/Stop)

Used to remotely start and stop the pump using a close=stop or open=stop signal. If the pump must start when the loop is open, then select “Close: Stop Pump” option. Can be used with an external foot pedal, a PLC, contact closure, or other similar external devices.

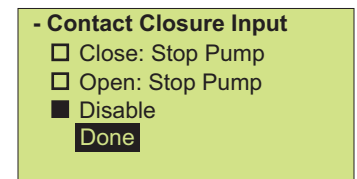

Default settings: Disable

CC Input Range: 6 - 30 VDC
or
Dry Contact Closure (no voltage required)
[See section 5.1 for wire connections]

Navigate to **Contact Input** menu by holding the START button for 5 seconds.

Press UP or DOWN arrow to scroll through your options.

Press START to make a selection. The radio button (square box) is now filled in next to your selection.

Press DOWN arrow to scroll down to Done selection. Then press START.

IMPORTANT: To begin operation, press the START button to place pump in STANDBY. The display background will turn blue indicating the pump has been stopped remotely. When the pump is started by the remote contact, the display background will turn green.

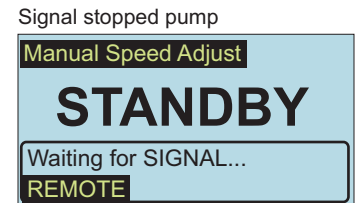

IMPORTANT: If the Contact Closure Input is enabled, the pump will display STANDBY if the pump has been stopped by the Remote Contact Closure. **Please use caution in this mode as the pump may Start at anytime. If you must perform maintenance to the pump, Press STOP button.**

When Contact Closure Input is enabled, the word **Remote** will always be displayed on the lower left side of the display screen.

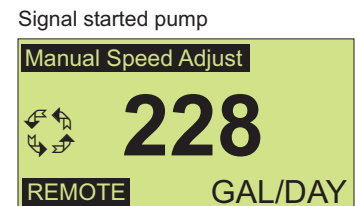

10.0 Pump Tube Timer

Flex-Pro has a built in Pump Tube Timer. Timer starts when rotor is rotating and stops when rotor is idle. To view current Pump Tube Timer value, press START button repeatedly until the Tube Timer screen appears. Screen will display current Pump Tube Time in run-time hours. The Tube Timer screen will display for 4 seconds and then switch back to the previous operating display screen.

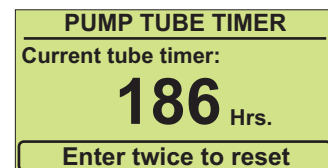

While displayed, press DOWN arrow button twice to reset Pump Tube Timer to zero.

When replacing pump tube, pump will ask you if you'd like to reset Pump Tube Timer. If you choose YES, screen will display current Pump Tube Time for 5 seconds before timer is reset to zero.

11.0 TFD (Tube Failure Detection)

Flex-Pro is equipped with a *Tube Failure Detection* System which is designed to stop the pump and provide an output alarm (see Output menu) in the event pump the tube should rupture and chemical enters the pump head. The pump will detect a chemical with a conductivity reading greater than 500 microsiemens. Chemicals with a conductivity of less than 500 microsiemens will not be detected.

This patented system is capable of detecting the presence of a large number of chemicals including Sodium Hypochlorite (Chlorine), Hydrochloric (muriatic) Acid, Sodium Hydroxide, and many others. The system will not be triggered by water (rain, condensation, etc.) or silicone oil (roller and tubing lubricant).

If system has detected chemical, pump tube must be replaced and pump head and roller assembly must be thoroughly cleaned. Failure to clean the roller assembly will void warranty.

If TFD alarm occurs, pump will stop, close an alarm output (if configured), and screen will flash TFD with an alarm icon.

Confirm Chemical Detection - To determine if your chemical will be detected by the system, remove the pump head cover and the pump tube and roller assembly. Place a small amount of chemical in the bottom of the pump head - just enough to cover the sensors. Replace the pump head cover only. When asked if the tube was replaced, select "no" and press enter. Turn on the pump (press start). If the TFD system detects the chemical, the pump will stop after a two second confirmation period and the TFD Alarm screen will display. If the TFD system does not detect the chemical, the pump will continue to run after the confirmation period. Carefully clean the chemical out of the pump head being sure to remove all traces of the chemical from sensor probes. Replace the roller assembly and tubing. Replace the pump head cover. Press the START button to clear the alarm condition and restart the pump.

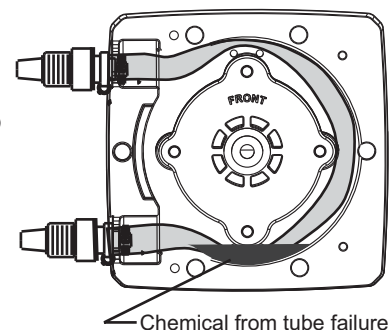

When a TFD alarm occurs



12.0 Alarm Relay

Pump has a built in 6 amp alarm output relay. Relay is pre-configured to energize on tube failure detection (TFD) and on Flow Verification Sensor (FVS).

A Flow Verification Sensor must be installed and configured for relay to trigger on no-flow conditions.

9.0 Set FVS (Flow Verification System)

Used to monitor pump output. If pump does not dispense fluid when pump head rotor is turning, pump will go into an alarm mode and stop pump. Blue-White offers a flow verification sensor that can easily attach to fitting on pump.

Default settings: 000 (off)

Navigate to **Set FVS** menu by pressing **UP** and **DOWN** arrows at the same time, then select Input Setup, then **Set FVS**.

Press UP or DOWN arrow to set the FVS delay time in seconds.

Press START to save changes and exit FVS screen.

Flow Verification System (sensor sold separately)

Flex-Pro is equipped with a *Flow Verification System* which is designed to stop pump and energize a 6 amp relay in event sensor does not detect chemical during pump operation. This could indicate a clogged injection fitting, empty chemical solution tank, worn pump tube, loose tubing connection, etc.

To allow pump to clear any gasses that may have accumulated during stopper operation (such as with chlorine), an alarm delay time value from 1-255 seconds must be programmed (An alarm delay value of 000 seconds disables FVS system).

If FVS alarm occurs, pump will stop, send an external signal (if setup), and screen will flash FVS with an alarm icon.

To clear FVS alarm, you must press START button or re-cycle power (unplug power to pump, then plug back in).

Install FVS Flow Sensor - Flow Verification Sensor (FVS) should be installed on the inlet (suction) side of the pump tube. Sensor includes a PVC tubing insert, located inside sensors female thread connection, that is designed to seal sensor onto pump tube inlet adapter. Thread sensor onto pump tube until tubing insert is snug against pump tube inlet fitting - do not over-tighten.

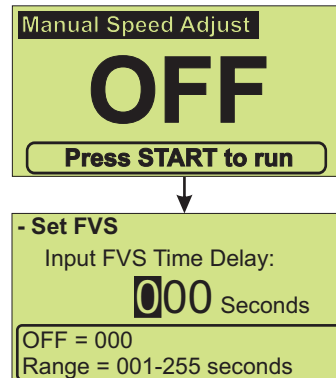

When a FVS alarm occurs

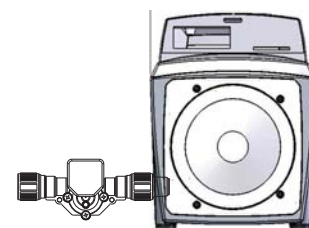

Confirm the FVS flow range - Flow Verification Sensor (FVS) will only function within its operating range. See chart for available ranges.



NOTE: For low viscosity (water-like) fluids only. Consult the factory if attempting to use with viscous fluids.

SENSOR MODEL NUMBER		OPERATING FLOW RANGE (ml/min)
3/8" OD tube connections	1/2" F/NPT connections	
FV-100-6V	FV-100-3V	30-300
FV-200-6V	FV-200-3V	100-1000
FV-300-6V	FV-300-3V	200-2000
FV-400-6V	FV-400-3V	300-3000
FV-500-6V	FV-500-3V	500-5000
FV-600-6V	FV-600-3V	700-7000



13.0 Reverse Rotor Rotation

Increase tube life with this feature!

CAUTION 	Prior to service, pump clean water through the pump and suction / discharge line to remove chemical.
CAUTION 	Always wear protective clothing, face shield, safety glasses and gloves when working on or near your metering pump. Additional precautions should be taken depending on solution being pumped. Refer to MSDS precautions from your solution supplier.

Pump rotor can reverse rotation by pressing REVERSE ROTATION button. This process can be used for many reasons throughout various industries.

Two reasons for reversing current rotor rotation; to purge chemical from tubing and to extend tube life.

Plan ahead before reversing rotor rotation. If checkvalves are installed, make necessary arrangements to allow back flow.

CAUTION 	Failure to install checkvalves in their proper flow direction can cause excess pressure (PSIg) build up in system and can result in tube rupture. Always use extreme caution and ensure proper connections when using this feature.
---	---

If your desire is to simply extend tube life:

Typically tubing fails on outlet side (pressure side) of tube assembly in pump head.

Reversing rotation, moves outlet side (pressure side) to opposite side of tube assembly, greatly increasing tube life.

Stop pump before tube failure occurs.

 Disconnect power from pump. Carefully purge any pressure in discharge line of pump. Disconnect suction end tubing and discharge end tubing from pump head tubing.

IMPORTANT! Swap sides of suction (inlet) and discharge (outlet) tubing. No need to remove Pump Head Cover.

Double check all connections before starting pump.

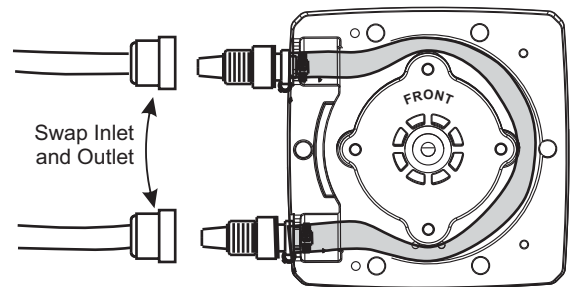
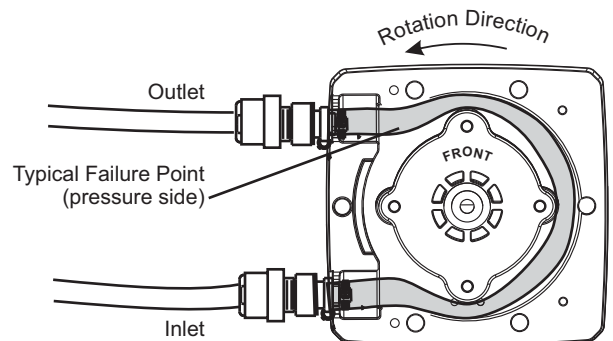

14.0 How to Maintain Pump

CAUTION

Always wear protective clothing, face shield, safety glasses and gloves when working on or near your metering pump. Additional precautions should be taken depending on solution being pumped. Refer to MSDS precautions from your solution supplier.

Routine Inspection and Maintenance

Pump requires very little maintenance. However, pump and all accessories should be checked weekly. This is especially important when pumping chemicals. Inspect all components for signs of leaking, swelling, cracking, discoloration or corrosion. Replace worn or damaged components immediately.

Cracking, crazing, discoloration and the like during first week of operation are signs of severe chemical attack. If this occurs, immediately remove chemical from pump. Determine which parts are being attacked and replace them with parts that have been manufactured using more suitable materials. Manufacturer does not assume responsibility for damage to pump that has been caused by chemical attack.

How to Clean and Lubricate Pump

Pump will require occasional cleaning. The amount will depend on severity of service.

☞ When changing pump tube assembly, pump head chamber, roller assembly and pump head cover should be wiped free of any dirt and debris.





☞ Pump head cover bearing may require grease periodically. Apply a small amount of grease (Aeroshell aviation grease #5 or equivalent) when necessary.

☞ Although not necessary, 100% silicon lubrication may be used on the roller assembly and tube assembly.

☞ Periodically clean injection/check valve assembly, especially when injecting fluids that calcify such as sodium hypochlorite. These lime deposits and other build ups can clog fitting, increase the back pressure and interfere with check valve operation.

☞ Periodically clean suction strainer.

15.0 Tube Replacement

CAUTION 	Prior to service, pump clean water through the pump and suction / discharge line to remove chemical.
CAUTION 	Always wear protective clothing, face shield, safety glasses and gloves when working on or near your metering pump. Additional precautions should be taken depending on solution being pumped. Refer to MSDS precautions from your solution supplier.
CAUTION 	Use provided Tube Installation Tool to leverage tubing into pump head, NOT YOUR FINGERS .
CAUTION 	Use extreme caution when replacing pump tube. Be careful of your fingers and DO NOT place fingers near rollers .

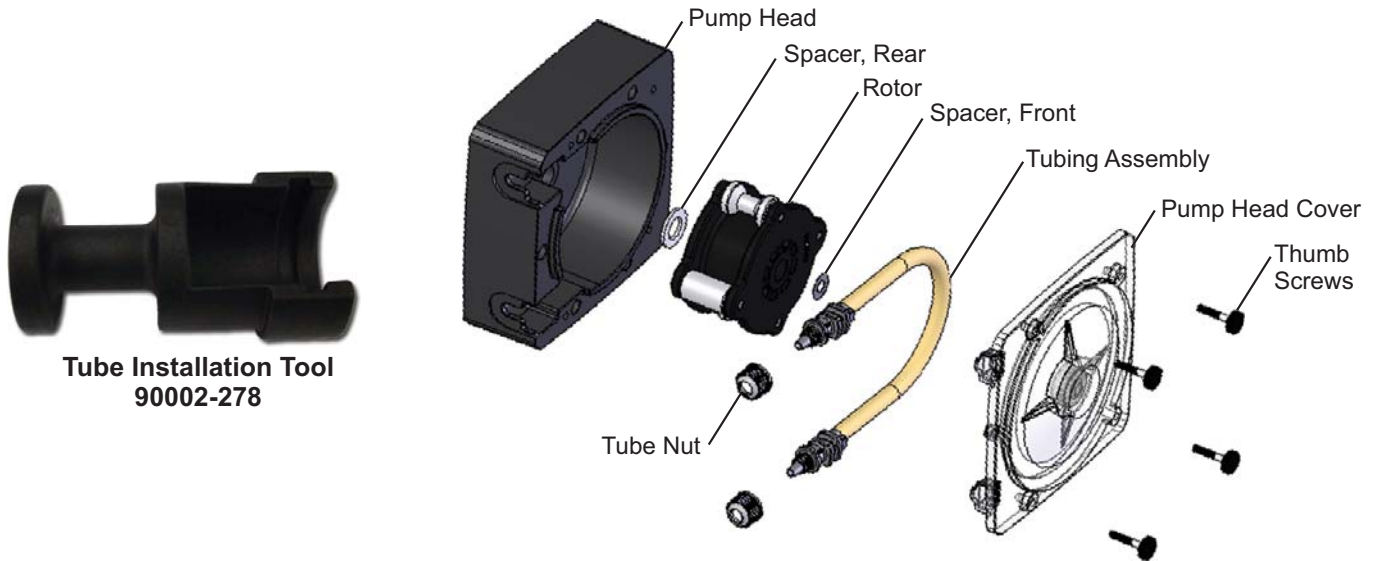

Remove **Pump Head Cover** by unscrewing four **Thumb Screws**. Pull out **Pump Head Cover**.

Pump will detect **Pump Head Cover** is removed and enter MAINTENANCE MODE.

Rotor will rotate at a maximum of 6 RPM for your safety.

Pull out suction side of **Tubing Assembly**.

Press START button. While rotor is rotating, pull out old **Tube Assembly**.

TIP! Let pump do the work for you. Just guide tubing out between two rollers located on **Rotor**.

Press STOP button at any time to stop the pump.

Pull out suction line adapter from Pump Head. Pull out **Tubing Assembly** as the **Rotor** rotates around.

Stop pump by pressing STOP button.

Thoroughly clean **Pump Head** and **Rotor**. **Rotor** can be removed by pulling straight out. After cleaning process, push **Rotor** back on shaft. See drawing above for proper assembly. IMPORTANT! **Rotor** direction; the word "FRONT" on **Rotor** must face front of pump.

Locate your new tubing and Tube Installation Tool. Please see next page on how to install new **Tube Assembly** into **Pump Head**.

MAINTENANCE MODE

Pump Cover Removed!

MAINTENANCE MODE

- Cover was removed!
- Motor Speed = 6 RPM

Press **START** to run
Press **STOP** to stop

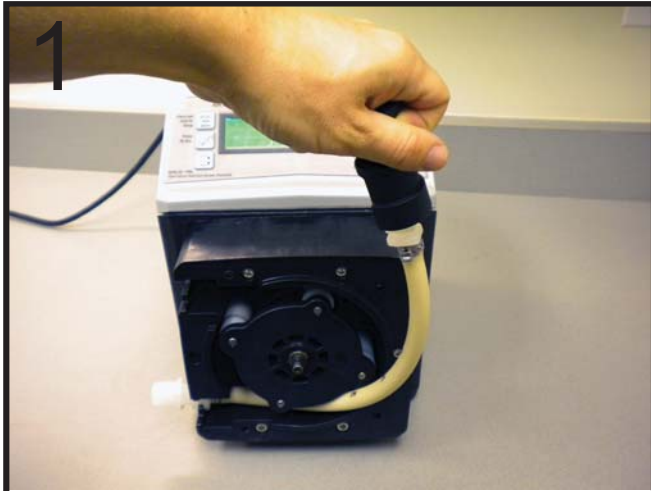

1
Insert suction fitting into pump head. Remove your fingers from pump head. Start pump by pressing **START** button. Grab hold of Tube Installation Tool and use it to leverage tubing into pump head.



2
Introduce tubing into pump head while the rotor is rotating. Avoid using fingers to guide the tubing. Stop pump at anytime by pressing **STOP** button. Start pump by pressing **START** button.

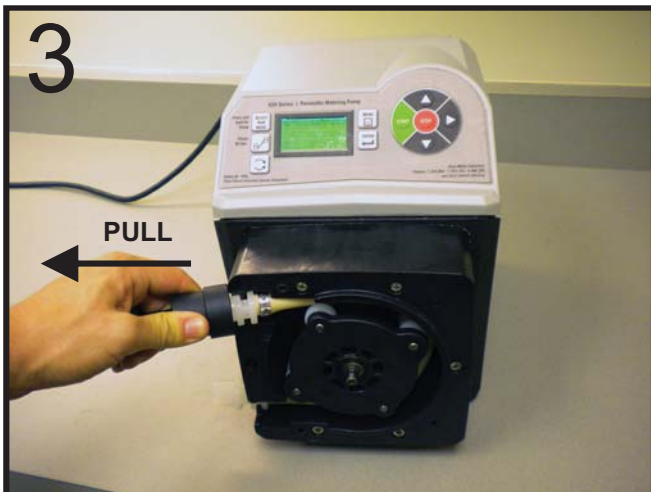

3
Continue to follow rotation of rotor while directing tube into pump head. At this point, you may need to pull Tube Installation Tool to stretch tubing into position. Let rotor spin a few rotations while pulling Installation tool so fitting can be properly installed.



4
Continue to pull Tube Installation Tool to allow enough room to slide discharge fitting into pump head tongue and groove. Once discharge fitting is secured in pump head, stop pump by pressing **STOP** button. Replace pump head cover. Pump will ask you if you'd like to reset tube timer. If you choose **yes**, current tube time will display for 5 seconds before resetting to zero. Make note of your displayed tube life. Select Yes again to reset tube life timer.

Re-attach **Pump Head Cover** using the four **Thumb Screws**.

Pump will detect **Pump Head Cover** is installed and begin to exit **MAINTENANCE MODE**.

Pump will ask you if Tube was replaced. Yes / No

If Yes is selected, pump ask you to reset Tube Timer. Yes / No

If Yes is selected, pump will display Current Tube Timer briefly (5 seconds) before resetting to zero.

The pump can now begin normal operation.

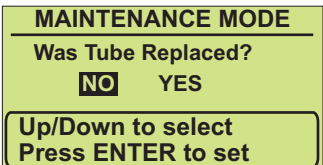
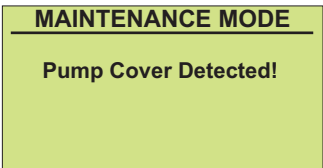

16.0 Flex-Pro Model A3 replacement parts list

	Item	Description	Part Number	QTY
	2	Spacer, Back	90011-184	1
Norprene®	3	Roller Assembly Complete (Rotor), For ND Tubes	A3-SND-R	1
	4	Tube Assembly, 3/8" tube connect, Norprene ND (.075 ID)	A3-SND-T	1
	4	Tube Assembly, 1/2" Male NPT connect, Norprene ND (.075 ID)	A3-MND-T	1
Norprene®	3	Roller Assembly Complete (Rotor), For NJ, NK, NKL, Tubes	A3-SNH-R	1
	4	Tube Assembly, 3/8" tube connect, Norprene NJ (.312 ID)	A3-SNJ-T	1
	4	Tube Assembly, 1/2" Male NPT connect, Norprene NJ (.312 ID)	A3-MNJ-T	1
	4	Tube Assembly, 3/8" tube connect, Norprene NK (.375 ID)	A3-SNK-T	1
	4	Tube Assembly, 1/2" Male NPT connect, Norprene NK (.375 ID)	A3-MNK-T	1
	4	Tube Assy, 3/8" tube cont, Norprene NKL (.375 ID) Low Pressure (30 psi max)	A3-SNKL-T	1
	4	Tube Assy, 1/2" Male NPT, Norprene NKL (.375 ID) Low Pressure (30 psi max)	A3-MNKL-T	1
Flex-A-Prene®	3	Roller Assembly Complete (Rotor), For NEE and NGG Tubes	A3-SNGG-R	1
	4	Tube Assembly, Quick Disconnect, Flex-A-Prene NEE (0.93 ID)	A3-QNEE-T	1
	4	Tube Assembly, 1/4" Tube Compression, Flex-A-Prene NEE (0.93 ID)	A3-SNEE-T	1
	4	Tube Assembly, 1/2" Male NPT, Flex-A-Prene NEE (0.93 ID)	A3-MNEE-T	1
	4	Tube Assembly, 1/2" Hose Barb, Flex-A-Prene NEE (0.93 ID)	A3-BNEE-T	1
	4	Tube Assembly, 1/2" - 3/4" Sanitary Fitting, Flex-A-Prene NEE (0.93 ID)	A3-CNEE-T	1
	4	Tube Assembly, Quick Disconnect, Flex-A-Prene NEE (0.187 ID)	A3-QNGG-T	1
	4	Tube Assembly, 1/4" Tube Compression, Flex-A-Prene NEE (0.187 ID)	A3-SNGG-T	1
	4	Tube Assembly, 1/2" Male NPT, Flex-A-Prene NEE (0.187 ID)	A3-MNGG-T	1
	4	Tube Assembly, 1/2" Hose Barb, Flex-A-Prene NEE (0.187 ID)	A3-BNGG-T	1
	4	Tube Assembly, 1/2" - 3/4" Sanitary Fitting, Flex-A-Prene NEE (0.187 ID)	A3-CNGG-T	1
Tygothane®	3	Roller Assembly Complete (Rotor), For GE, GG, GH, GK Tubes	A3-SGE-R	1
	4	Tube Assembly, 3/8" tube connect, Tygothane GE (.125 ID)	A3-SGE-T	1
	4	Tube Assembly, 1/2" Male NPT connect, Tygothane GE (.125 ID)	A3-MGE-T	1
	4	Tube Assembly, 3/8" tube connect, Tygothane GG (.187 ID)	A3-SGG-T	1
	4	Tube Assembly, 1/2" Male NPT connect, Tygothane GG (.187 ID)	A3-MGG-T	1
	4	Tube Assembly, 3/8" tube connect, Tygothane GH (.250 ID)	A3-SGH-T	1
	4	Tube Assembly, 1/2" Male NPT connect, Tygothane GH (.250 ID)	A3-MGH-T	1
	4	Tube Assembly, 3/8" tube connect, Tygothane GK (.375 ID)	A3-SGK-T	1
	4	Tube Assembly, 1/2" Male NPT connect, Tygothane GK (.375 ID)	A3-MGK-T	1
Norprene® Chemical	3	Roller Assembly Complete (Rotor), For TH, TK Tubes	A3-STH-R	1
	4	Tube Assembly, 3/8" tube connect, Norprene Chemical TH (.250 ID)	A3-STH-T	1
	4	Tube Assembly, 1/2" Male NPT, Norprene Chemical TH (.250 ID)	A3-MTH-T	1
	4	Tube Assembly, 3/8" tube connect, Norprene Chemical TK (.375 ID)	A3-STK-T	1
	4	Tube Assembly, 1/2" Male NPT, Norprene Chemical TK (.375 ID)	A3-MTK-T	1
	6	Pump Head Cover, Polycarbonate - New design, backwards compatible	A3-SXX-C	1
	7	Thumb Screw	90011-183	4
	8	Tube Nut, Compression, For 3/8" Tubing	C-330-6	2
Not Shown		Stainless Steel mounting bracket kit (pair)	72000-379	1
Not Shown		Stainless Steel extended mounting bracket kit (pair)	72000-380	1
Not Shown		Rubber feet	90003-561	4

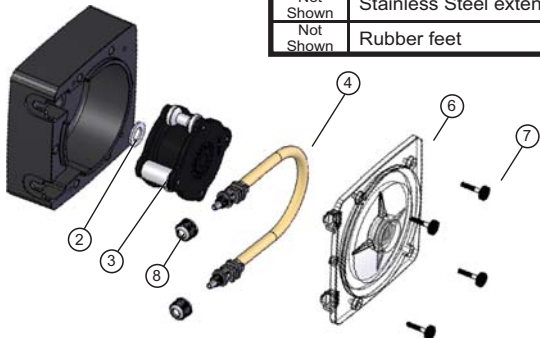

Flex-A-Prene® Upgrade Kit

Model #	Description
72000-537	Roller Assembly and Pump Head Cover

Upgrade existing A3 pumps with Flex-A-Prene® Upgrade Kit to be compatible with all new Flex-A-Prene® tubes.

17.0 Flex-Pro Model A4 replacement parts list

	Item	Description	Part Number	QTY
	2	Spacer, two spacers required, A4 (replaces 90011-184)	90011-217	2
Norprene®	3	Roller Assy Complete (A4 Rotor), For NH, NJ, NK Tubes	A4-MNH-R	1
	4	Tube Assembly, 1/2" hose barb, Norprene NH (.25 ID)	A4-BNH-T	1
	4	Tube Assembly, 1/2" Male NPT, Norprene NH (.25 ID)	A4-MNH-T	1
	4	Tube Assembly, 1/2" hose barb, Norprene NJ (.31 ID)	A4-BNJ-T	1
	4	Tube Assembly, 1/2" Male NPT, Norprene NJ (.31 ID)	A4-MNJ-T	1
	4	Tube Assembly, 1/2" hose barb, Norprene NK (.38 ID)	A4-BNK-T	1
	4	Tube Assembly, 1/2" Male NPT, Norprene NK (.38 ID)	A4-MNK-T	1
Norprene®	3	Roller Assy Complete (A4 Rotor), For NL, NP Tubes	A4-MNL-R	1
	4	Tube Assembly, 1/2" hose barb, Norprene NL (.50 ID)	A4-BNL-T	1
	4	Tube Assembly, 1/2" Male NPT, Norprene NL (.50 ID)	A4-MNL-T	1
	4	Tube Assembly, 1/2" hose barb, Norprene NP (.75 ID)	A4-BNP-T	1
	4	Tube Assembly, 1/2" Male NPT, Norprene NP (.75 ID)	A4-MNP-T	1
Norprene® and Norprene® Chemical	3	Roller Assy Complete (A4 Rotor), For NKL, NHH, NKLL, TH, TK, THH, TTK Tubes	A4-MTH-R	1
	4	Tube Assy, 1/2" Male NPT, Norprene NKL (.38 ID)	A4-MNKL-T	1
	4	Tube Assy, 1/2" hose barb, Norprene NKL (.38 ID)	A4-BNKL-T	1
	4	Tube Assy, 1/2" hose barb, Dual Norprene NH & NH (.25 + .25 ID)	A4-BNHH-T	1
	4	Tube Assy, 1/2" Male NPT, Dual Norprene NH & NH (.25 + .25 ID)	A4-MNHH-T	1
	4	Tube Assy, 1/2" hose barb, Dual Norprene NKL & NKL (.38 + .38 ID)	A4-BNKKL-T	1
	4	Tube Assy, 1/2" Male NPT, Dual Norprene NKL & NKL (.38 + .38 ID)	A4-MNKKL-T	1
	4	Tube Assembly, 1/2" hose barb, Norprene Chemical TH (.25 ID)	A4-BTH-T	1
	4	Tube Assembly, 1/2" Male NPT, Norprene Chemical TH (.25 ID)	A4-MTH-T	1
	4	Tube Assembly, 1/2" hose barb, Norprene Chemical TK (.38 ID)	A4-BTK-T	1
	4	Tube Assembly, 1/2" Male NPT, Norprene Chemical TK (.38 ID)	A4-MTK-T	1
	4	Tube Assy, 1/2" hose barb, Dual Norprene Chemical TH & TH (.25 + .25 ID)	A4-BTHH-T	1
	4	Tube Assy, 1/2" Male NPT, Dual Norprene Chemical TH & TH (.25 + .25 ID)	A4-MTHH-T	1
	4	Tube Assy, 1/2" hose barb, Dual Norprene Chemical TK & TK (.38 + .38 ID)	A4-BTKK-T	1
	4	Tube Assy, 1/2" Male NPT, Dual Norprene Chemical TK & TK (.38 + .38 ID)	A4-MTKK-T	1
Tygothane®	3	Roller Assy Complete (A4 Rotor), For GH, GK, GHH, GKK Tubes	A4-MGH-R	1
	4	Tube Assembly, 1/2" hose barb, Tygothane GH (.25 ID)	A4-BGH-T	1
	4	Tube Assembly, 1/2" Male NPT, Tygothane GH (.25 ID)	A4-MGH-T	1
	4	Tube Assembly, 1/2" hose barb, Tygothane GK (.38 ID)	A4-BGK-T	1
	4	Tube Assembly, 1/2" Male NPT, Tygothane GK (.38 ID)	A4-MGK-T	1
	4	Tube Assy, 1/2" hose barb, Dual Tygothane GH & GH (.25 + .25 ID)	A4-BGHH-T	1
	4	Tube Assy, 1/2" Male NPT, Dual Tygothane GH & GH (.25 + .25 ID)	A4-MGHH-T	1
	4	Tube Assy, 1/2" hose barb, Dual Tygothane GK & GK (.38 + .38 ID)	A4-BGKK-T	1
	4	Tube Assy, 1/2" Male NPT, Dual Tygothane GK & GK (.38 + .38 ID)	A4-MGKK-T	1
Not Shown	Stainless Steel mounting bracket kit (pair)	72000-379	1	
Not Shown	Stainless Steel extended mounting bracket kit (pair)	72000-380	1	
Not Shown	Rubber feet	90003-561	4	

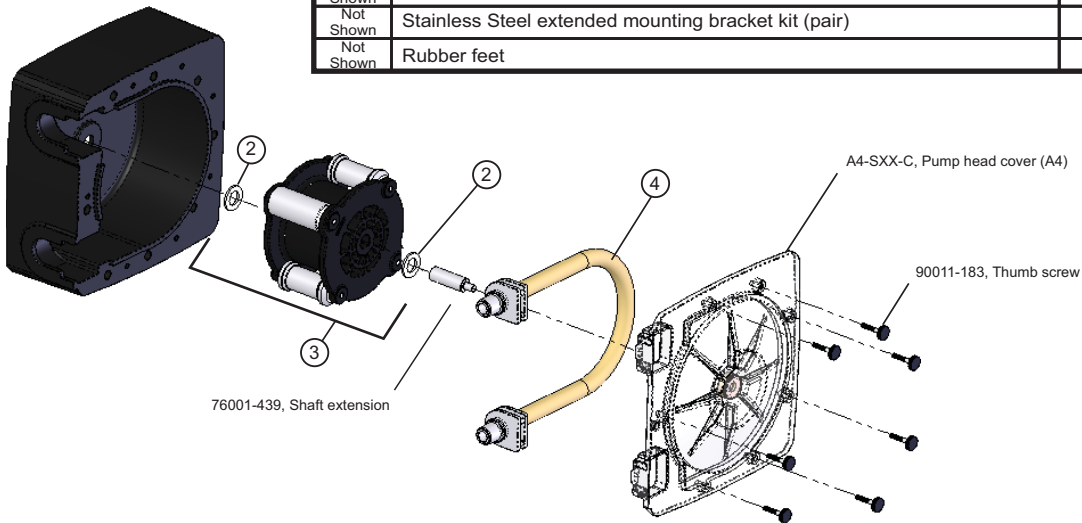

LIMITED WARRANTY

Your new Flex-Pro pump is a quality product and is warranted for 24 months from date of purchase (proof of purchase is required). The pump will be repaired or replaced at our discretion. Pump Head and roller assembly is warranted against damage from chemical attack when proper TFD (Tube Failure Detection) system instructions and maintenance procedures are followed.

WHAT IS NOT COVERED

- **Pump Tube Assemblies and rubber components – They are perishable and require periodic replacement.**
- **Pump removal, or re-installation, and any related labor charge.**
- **Freight to the factory, or ProSeries service center.**
- **Pumps that have been tampered with, or in pieces.**
- **Damage to the pump that results from misuse, carelessness such as chemical spills on the enclosure, abuse, lack of maintenance, or alteration which is out of our control.**
- **Pumps damaged by faulty wiring, power surges or acts of nature.**

Blue-White Industries does not assume responsibility for any loss, damage, or expense directly or indirectly related to or arising out of the use of its products. Failure must have occurred due to defect in material or workmanship and not as a result of operation of the product other than in normal operation as defined in the pump manual.

Warranty status is determined by the pump's serial label and the sales invoice or receipt. The serial label must be on the pump and legible. The warranty status of the pump will be verified by Blue-White or a factory authorized service center.

OTHER IMPORTANT WARRANTY INFORMATION

Please be advised; injection and metering devices are not intended as a means of treating water to render it suitable for human consumption. When used as hypochlorinators, they are meant to destroy bacteria and algae contamination, before its removal by filtration. Acid and soda injectors are used for PH control (balance). Blue-White injectors are factory tested with water only for pressure and performance. Installers and operators of these devices must be well informed and aware of the precautions to be taken when injecting various chemicals -especially those considered hazardous or dangerous, eye protection must be worn when working around this product or any other metering type of pump.

Should it become necessary to return the pump for repair or service, you must attach information regarding the chemical used as some residue may be present within the unit which could be a hazard to service personnel.

Blue-White Industries will not be liable for any damage that may result by the use of chemicals with their injectors and its components. Thank you.

PROCEDURE FOR IN WARRANTY REPAIR

Contact the factory to obtain a RMA (Return Material Authorization) number. Carefully pack the pump to be repaired. It is recommended to include foot strainer and injection/check valve fitting since these devices may be clogged and part of the problem. Please enclose a brief description of the problem as well as the original invoice or sales receipt, or copy showing the date of purchase. Prepay all shipping costs. COD shipments will not be accepted. Warranty service must be performed by the factory or an authorized ProSeries service center. Damage caused by improper packaging is the responsibility of the sender. When In-Warranty repair or replacement is completed, the factory pays for return shipping to the dealer or customer.



Users of electrical and electronic equipment (EEE) with the WEEE marking per Annex IV of the WEEE Directive must not dispose of end of life EEE as unsorted municipal waste, but use the collection framework available to them for the return, recycle, recovery of WEEE and minimize any potential effects of EEE on the environment and human health due to the presence of hazardous substances. The WEEE marking applies only to countries within the European Union (EU) and Norway. Appliances are labeled in accordance with European Directive 2002/96/EC. Contact your local waste recovery agency for a *Designated Collection Facility* in your area.

ProSeries[®]
by Blue-White Ind.

5300 Business Drive, Huntington Beach, CA 92649 USA

Phone: 714-893-8529 FAX: 714-894-9492

E mail: sales@blue-white.com or techsupport@blue-white.com URL: www.blue-white.com