

# DMX 221

## Dosing pump

### Installation and operating instructions



## Declaration of conformity

### GB: EC declaration of conformity

We, Grundfos, declare under our sole responsibility that the product DMX 221, to which this declaration relates, is in conformity with these Council directives on the approximation of the laws of the EC member states:

- Machinery Directive (2006/42/EC).  
Standards used: EN 809:1998+A1:2009, EN ISO 12100-1+A1:2009, EN ISO 12100-2+A1:2009.
- Low Voltage Directive (2006/95/EC).  
Standard used: EN 61010-1:2001 (second edition).
- EMC Directive (2004/108/EC).\*

\* Only for products with control variant AR or AT.

This EC declaration of conformity is only valid when published as part of the Grundfos installation and operating instructions.

### DE: EG-Konformitätserklärung

Wir, Grundfos, erklären in alleiniger Verantwortung, dass das Produkt DMX 221, auf das sich diese Erklärung bezieht, mit den folgenden Richtlinien des Rates zur Angleichung der Rechtsvorschriften der EU-Mitgliedsstaaten übereinstimmt:

- Maschinenrichtlinie (2006/42/EG).  
Normen, die verwendet wurden: EN 809:1998+A1:2009, EN ISO 12100-1+A1:2009, EN ISO 12100-2+A1:2009.
- Niederspannungsrichtlinie (2006/95/EG).  
Norm, die verwendet wurde: EN 61010-1:2001 (zweite Ausgabe).
- EMV-Richtlinie (2004/108/EG).\*

\* Nur für Produkte mit Steuerungsvariante AR oder AT.

Diese EG-Konformitätserklärung gilt nur, wenn sie in Verbindung mit der Grundfos Montage- und Betriebsanleitung veröffentlicht wird.

### ES: Declaración CE de conformidad

Nosotros, Grundfos, declaramos bajo nuestra propia responsabilidad que el producto DMX 221, al cual se refiere esta declaración, está conforme con las Directivas del Consejo en la aproximación de las leyes de los Estados Miembros del EM:

- Directiva de Maquinaria (2006/42/CE).  
Normas aplicadas: EN 809:1998+A1:2009, EN ISO 12100-1+A1:2009, EN ISO 12100-2+A1:2009.
- Directiva de Baja Tensión (2006/95/CE).  
Norma aplicada: EN 61010-1:2001 (segunda edición).
- Directiva EMC (2004/108/CE).\*

\* Solo para productos con variante de control AR o AT.

Esta declaración CE de conformidad sólo es válida cuando se publique como parte de las instrucciones de instalación y funcionamiento de Grundfos.

### HR: EZ izjava o usklađenosti

Mi, Grundfos, izjavljujemo pod vlastitom odgovornošću da je proizvod DMX 221, na koji se ova izjava odnosi, u skladu s direktivama ovog Vijeća o usklađivanju zakona država članica EU:

- Direktiva za strojeve (2006/42/EZ).  
Korištene norme: EN 809:1998+A1:2009, EN ISO 12100-1+A1:2009, EN ISO 12100-2+A1:2009.
- Direktiva za niski napon (2006/95/EZ).  
Korištena norma: EN 61010-1:2001 (drugo izdanje).
- Direktiva za elektromagnetsku kompatibilnost (2004/108/EZ).\*

\* Samo za proizvode s vrstom upravljanja AR ili AT.

Ova EZ izjava o sukladnosti važeća je jedino kada je izdana kao dio Grundfos montažnih i pogonskih uputa.

### LV: EK atbilstības deklarācija

Sabiedrība GRUNDFOS ar pilnu atbildību dara zināmu, ka produkts DMX 221, uz kuru attiecas šīs paziņojums, atbilst šādām Padomes direktīvām par tuvināšanas EK dalībvalstu likumdošanas normām:

- Mašīnbūves direktīva (2006/42/EK).  
Piemērotie standarti: EN 809:1998+A1:2009, EN ISO 12100-1+A1:2009, EN ISO 12100-2+A1:2009.
- Zema sprieguma direktīva (2006/95/EK).  
Piemērotais standarts: EN 61010-1:2001 (otrā versija).
- Elektromagnētiskās saderības direktīva (2004/108/EK).\*

\* Tikai produktiem ar AR vai AT kontroles variantu.

Šī EK atbilstības deklarācija ir derīga vienīgi tad, ja ir publicēta kā daļa no GRUNDFOS uzstādīšanas un ekspluatācijas instrukcijām.

### CZ: ES prohlášení o shodě

My firma Grundfos prohlašujeme na svou plnou odpovědnost, že výrobek DMX 221, na nějž se toto prohlášení vztahuje, je v souladu s ustanoveními směrnice Rady pro sblížení právních předpisů členských států Evropského společenství v oblastech:

- Směrnice pro strojní zařízení (2006/42/ES).  
Použité normy: EN 809:1998+A1:2009, EN ISO 12100-1+A1:2009, EN ISO 12100-2+A1:2009.
- Směrnice pro nízkonapětové aplikace (2006/95/ES).  
Použitá norma: EN 61010-1:2001 (druhé vydání).
- Směrnice pro elektromagnetickou kompatibilitu (EMC) (2004/108/ES).\*

\* Pouze pro výrobky s variantou řízení AR nebo AT.

Toto ES prohlášení o shodě je platné pouze tehdy, pokud je zveřejněno jako součást instalačních a provozních návodů Grundfos.

### GR: Δήλωση συμμόρφωσης EC

Εμείς, η Grundfos, δηλώνουμε με αποκλειστικά δική μας ευθύνη ότι τα προϊόντα DMX 221, στα οποία αναφέρεται η παρούσα δήλωση, συμμορφώνονται με τις εξής Οδηγίες του Συμβουλίου περί προσέγγισης των νομοθεσιών των κρατών μελών της ΕΕ:

- Οδηγία για μηχανήματα (2006/42/ΕC).  
Πρότυπα που χρησιμοποιήθηκαν: EN 809:1998+A1:2009, EN ISO 12100-1+A1:2009, EN ISO 12100-2+A1:2009.
- Οδηγία χαμηλής τάσης (2006/95/ΕC).  
Πρότυπο που χρησιμοποιήθηκε: EN 61010-1:2001 (δεύτερη έκδοση).
- Οδηγία Ηλεκτρομαγνητικής Συμβατότητας (EMC) (2004/108/ΕC).\*

\* Μόνο για προϊόντα με τύπο ελέγχου AR ή AT.

Αυτή η δήλωση συμμόρφωσης EC ισχύει μόνον όταν συνοδεύει τις οδηγίες εγκατάστασης και λειτουργίας της Grundfos.

### FR : Déclaration de conformité CE

Nous, Grundfos, déclarons sous notre seule responsabilité, que le produit DMX 221, auquel se réfère cette déclaration, est conforme aux Directives du Conseil concernant le rapprochement des législations des Etats membres CE relatives aux normes énoncées ci-dessous :

- Directive Machines (2006/42/CE).  
Normes utilisées : EN 809:1998+A1:2009, EN ISO 12100-1+A1:2009, EN ISO 12100-2+A1:2009.
- Directive Basse Tension (2006/95/CE).  
Norme utilisée : EN 61010-1:2001 (deuxième édition).
- Directive Compatibilité Electromagnétique CEM (2004/108/CE).\*

\* Uniquement pour produits avec variante de commande AR ou AT.

Cette déclaration de conformité CE est uniquement valide lors de sa publication dans la notice d'installation et de fonctionnement Grundfos.

### IT: Dichiarazione di conformità CE

Grundfos dichiara sotto la sua esclusiva responsabilità che il prodotto DMX 221, al quale si riferisce questa dichiarazione, è conforme alle seguenti direttive del Consiglio riguardanti il riavvicinamento delle legislazioni degli Stati membri CE:

- Direttiva Macchine (2006/42/CE).  
Norme applicate: EN 809:1998+A1:2009, EN ISO 12100-1+A1:2009, EN ISO 12100-2+A1:2009.
- Direttiva Bassa Tensione (2006/95/CE).  
Norma applicata: EN 61010-1:2001 (seconda edizione).
- Direttiva EMC (2004/108/CE).\*

\* Solo per prodotti con varianti di controllo AR o AT.

Questa dichiarazione di conformità CE è valida solo quando pubblicata come parte delle istruzioni di installazione e funzionamento Grundfos.

### HU: EK megfeleléségi nyilatkozat

Mi, a Grundfos, egyedüli felelősséggel kijelentjük, hogy a DMX 221 termék, amelyre jelen nyilatkozik vonatkozik, megfelel az Európai Unió tagállamainak jogi irányelveit összehangoló tanács alábbi előírásainak:

- Gépek (2006/42/EK).  
Alkalmazott szabványok: EN 809:1998+A1:2009, EN ISO 12100-1+A1:2009, EN ISO 12100-2+A1:2009.
- Kisfeszültségű Direktíva (2006/95/EK).  
Alkalmazott szabvány: EN 61010-1:2001 (második kiadás).
- EMC Direktíva (2004/108/EK).\*

\* Csak AR illetve AT vezérlési változat esetén.

Ez az EK megfeleléségi nyilatkozat kizárólag akkor érvényes, ha Grundfos telepítési és üzemeltetési utasítás részeként kerül kiadásra.

**NL: EC overeenkomstigheidsverklaring**

Wij, Grundfos, verklaren geheel onder eigen verantwoordelijkheid dat het product DMX 221 waarop deze verklaring betrekking heeft, in overeenstemming is met de Richtlijnen van de Raad in zake de onderlinge aanpassing van de wetgeving van de EG lidstaten betreffende:

- Machine Richtlijn (2006/42/EC).  
Gebruikte normen: EN 809:1998+A1:2009, EN ISO 12100-1+A1:2009, EN ISO 12100-2+A1:2009.
  - Laagspannings Richtlijn (2006/95/EC).  
Gebruikte norm: EN 61010-1:2001 (tweede editie).
  - EMC Richtlijn (2004/108/EC).\*
- \* Enkel voor producten met besturingsvariant AR of AT.

Deze EC overeenkomstigheidsverklaring is alleen geldig wanneer deze gepubliceerd is als onderdeel van de Grundfos installatie- en bedieningsinstructies.

**PT: Declaração de conformidade CE**

A Grundfos declara sob sua única responsabilidade que o produto DMX 221, ao qual diz respeito esta declaração, está em conformidade com as seguintes Directivas do Conselho sobre a aproximação das legislações dos Estados Membros da CE:

- Directiva Máquinas (2006/42/CE).  
Normas utilizadas: EN 809:1998+A1:2009, EN ISO 12100-1+A1:2009, EN ISO 12100-2+A1:2009.
  - Directiva Baixa Tensão (2006/95/CE).  
Norma utilizada: EN 61010-1:2001 (segunda edição).
  - Directiva EMC (compatibilidade electromagnética) (2004/108/CE).\*
- \* Apenas para produtos com sistema de controlo AR ou AT.

Esta declaração de conformidade CE é apenas válida quando publicada como parte das instruções de instalação e funcionamento Grundfos.

**RO: Declarație de conformitate CE**

Noi, Grundfos, declarăm pe propria răspundere că produsele DMX 221, la care se referă această declarație, sunt în conformitate cu aceste Directive de Consiliu asupra armonizării legilor Statelor Membre CE:

- Directiva Utilaje (2006/42/CE).  
Standarde utilizate: EN 809:1998+A1:2009, EN ISO 12100-1+A1:2009, EN ISO 12100-2+A1:2009.
  - Directiva Tensiune Joasă (2006/95/CE).  
Standard utilizat: EN 61010-1:2001 (a doua ediție).
  - Directiva EMC (2004/108/CE).\*
- \* Numai pentru produsele cu variantă control AR sau AT.

Această declarație de conformitate CE este valabilă numai când este publicată ca parte a instrucțiunilor Grundfos de instalare și funcționare.

**SE: EG-försäkran om överensstämmelse**

Vi, Grundfos, försäkrar under ansvar att produkten DMX 221, som omfattas av denna försäkran, är i överensstämmelse med rådets direktiv om inbördes närmande till EU-medlemsstaternas lagstiftning, avseende:

- Maskindirektivet (2006/42/EG).  
Tillämpade standarder: EN 809:1998+A1:2009, EN ISO 12100-1+A1:2009, EN ISO 12100-2+A1:2009.
  - Lågspänningsdirektivet (2006/95/EG).  
Tillämpad standard: EN 61010-1:2001 (andra upplagan).
  - EMC-direktivet (2004/108/EG).\*
- \* Endast för produkter med styrenhetsvariant AR eller AT.

Denna EG-försäkran om överensstämmelse är endast giltig när den publiceras som en del av Grundfos monterings- och driftsinstruktion.

**CN: EC 产品合格声明书**

我们格兰富在我们的全权责任下声明，产品 DMX 221，即该合格证所指之产品，符合欧共体使其成员国法律趋于一致的以下欧共理事会指令：

- 机械设备指令 (2006/42/EC)。  
所用标准：EN 809:1998+A1:2009, EN ISO 12100-1+A1:2009, EN ISO 12100-2+A1:2009。
  - 低电压指令 (2006/95/EC)。  
所用标准：EN 61010-1:2001 (第 2 版)。
  - 电磁兼容性指令 (2004/108/EC)。\*
- \* 仅对控制选项为 AR 或 AT 的型号有效。

本 EC 合格性声明仅在作为格兰富安装与操作指导手册的一部分时有效。

**PL: Deklaracja zgodności WE**

My, Grundfos, oświadczamy z pełną odpowiedzialnością, że nasze wyroby DMX 221, których deklaracja niniejsza dotyczy, są zgodne z następującymi wytycznymi Rady d/s ujednolicenia przepisów prawnych krajów członkowskich WE:

- Dyrektywa Maszynowa (2006/42/WE).  
Zastosowane normy: EN 809:1998+A1:2009, EN ISO 12100-1+A1:2009, EN ISO 12100-2+A1:2009.
  - Dyrektywa Niskonapięciowa (LVD) (2006/95/WE).  
Zastosowana norma: EN 61010-1:2001 (drugie wydanie).
  - Dyrektywa EMC (2004/108/WE).\*
- \* Tylko dla produktów w wersji sterowania AR lub AT.

Deklaracja zgodności WE jest ważna tylko i wyłącznie wtedy kiedy jest opublikowana przez firmę Grundfos i umieszczona w instrukcji montażu i eksploatacji.

**RU: Декларация о соответствии ЕС**

Мы, компания Grundfos, со всей ответственностью заявляем, что изделия DMX 221, к которым относится настоящая декларация, соответствуют следующим Директивам Совета Евросоюза об унификации законодательных предписаний стран-членов ЕС:

- Механические устройства (2006/42/ЕС).  
Применявшиеся стандарты: EN 809:1998+A1:2009, EN ISO 12100-1+A1:2009, EN ISO 12100-2+A1:2009.
  - Низковольтное оборудование (2006/95/ЕС).  
Применявшийся стандарт: EN 61010-1:2001 (второе издание).
  - Электромагнитная совместимость (2004/108/ЕС).\*
- \* Только для насосов с блоком управления AR или AT.

Данная декларация о соответствии ЕС имеет силу только в случае публикации в составе инструкции по монтажу и эксплуатации на продукцию производства компании Grundfos.

**SI: ES izjava o skladnosti**

V Grundfosu s polno odgovornostjo izjavljamo, da so naši izdelki DMX 221, na katere se ta izjava nanaša, v skladu z naslednjimi direktivami Sveta o približevanju zakonodaje za izenačevanje pravnih predpisov držav članic ES:

- Direktiva o strojih (2006/42/ES).  
Uporabljeni normi: EN 809:1998+A1:2009, EN ISO 12100-1+A1:2009, EN ISO 12100-2+A1:2009.
  - Direktiva o nizki napetosti (2006/95/ES).  
Uporabljena norma: EN 61010-1:2001 (druga izdaja).
  - Direktiva o elektromagnetni združljivosti (EMC) (2004/108/ES).\*
- \* Samo za izdelke z kontrolno različico AR ali AT.

ES izjava o skladnosti velja samo kadar je izdana kot del Grundfos instalacije in navodil delovanja.

**TR: EC uygunluk bildirgesi**

Grundfos olarak bu beyannameye konu olan DMX 221 ürünlerinin, AB Üyesi Ülkelerin kanunlarını birbirine yaklaştırma üzerine Konsey Direktifleriyle uyumlu olduğunun yalnızca bizim sorumluluğumuz altında olduğunu beyan ederiz:

- Makineler Yönetmeliği (2006/42/EC).  
Kullanılan standartlar: EN 809:1998+A1:2009, EN ISO 12100-1+A1:2009, EN ISO 12100-2+A1:2009.
  - Düşük Voltaj Yönetmeliği (2006/95/EC).  
Kullanılan standart: EN 61010-1:2001 (ikinci baskı).
  - EMC Direktifi (2004/108/EC).\*
- \* Sadece AR ve AT kontrol değişikliği ürünler için.

İşbu EC uygunluk bildirgesi, yalnızca Grundfos kurulum ve çalıştırma talimatlarının bir parçası olarak basıldığı takdirde geçerlilik kazanmaktadır.

Pfingztal, 15th May 2012

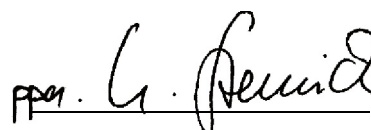

Ulrich Stemick  
Technical Director  
Grundfos Water Treatment GmbH  
Reetzstr. 85, D-76327 Pfingztal, Germany

Person authorised to compile technical file and empowered to sign the EC declaration of conformity.

## Original installation and operating instructions.

## CONTENTS

	Page		Page
<b>1. General information</b>	<b>4</b>	11.3 Cleaning the suction and discharge valves	21
1.1 Introduction	4	11.4 Maintenance of the relief valve	21
1.2 Applications	4	11.5 Replacing the diaphragm	22
1.3 Warranty	4	<b>12. Fault finding chart</b>	<b>23</b>
<b>2. Safety</b>	<b>4</b>	<b>13. Dosing curves</b>	<b>24</b>
2.1 Identification of safety instructions in this manual	4	<b>14. Disposal</b>	<b>28</b>
2.2 Qualification and training of personnel	5		
2.3 Risks when safety instructions are not observed	5		
2.4 Safety-conscious working	5		
2.5 Safety instructions for the operator/user	5		
2.6 Safety instructions for maintenance, inspection and installation work	5		
2.7 Unauthorised modification and manufacture of spare parts	5		
2.8 Improper operating methods	5		
2.9 Safety of the system in the event of a failure in the dosing system	5		
<b>3. Technical data</b>	<b>5</b>		
3.1 Identification	5		
3.2 Type key	6		
3.3 Pump performance	7		
3.4 Suction heights	8		
3.5 Ambient and operating conditions	9		
3.6 Dosing medium	9		
3.7 Electrical data	9		
3.8 AR control unit	9		
3.9 Materials	10		
3.10 Weights	10		
3.11 Dimensional sketches	11		
<b>4. Transport and storage</b>	<b>12</b>		
4.1 Delivery	12		
4.2 Intermediate storage	12		
4.3 Unpacking	12		
4.4 Return	12		
<b>5. Installation</b>	<b>13</b>		
5.1 Optimum installation	13		
5.2 Installation tips	13		
5.3 Mounting	14		
5.4 Hose / pipe lines	14		
5.5 Connecting the suction and discharge lines	14		
<b>6. Electrical connections</b>	<b>15</b>		
6.1 Versions with mains plug	15		
6.2 Versions without mains plug	15		
<b>7. Commissioning</b>	<b>16</b>		
7.1 Checks before start-up	16		
7.2 Start-up	16		
<b>8. Operation</b>	<b>16</b>		
8.1 Description of the pump	16		
8.2 Switching on/off	16		
8.3 Adjusting the dosing flow via the stroke length	17		
8.4 Stroke-length adjustment	17		
8.5 Adjustment of stroke rate using a frequency converter	17		
8.6 Using the AR control unit	17		
<b>9. Operation with other electronics</b>	<b>17</b>		
9.1 Electronics version stroke sensor	17		
9.2 Electronic diaphragm leakage sensor	18		
<b>10. Integral relief valve</b>	<b>20</b>		
10.1 Function	20		
10.2 Permissible media	20		
10.3 Connections	20		
10.4 Setting of opening pressure	20		
10.5 Venting	20		
10.6 Fault finding chart	21		
<b>11. Maintenance</b>	<b>21</b>		
11.1 General notes	21		
11.2 Cleaning and maintenance intervals	21		

**Warning**

*These complete installation and operating instructions are also available on [www.grundfos.com](http://www.grundfos.com).*

*Prior to installation, read these installation and operating instructions. Installation and operation must comply with local regulations and accepted codes of good practice.*

**1. General information****1.1 Introduction**

These installation and operating instructions contain all the information required for starting up and handling the DMX 221 dosing pump.

If you require further information or if any problems arise, which are not described in detail in this manual, please contact Grundfos.

**1.2 Applications**

The DMX 221 pump is suitable for liquid, non-abrasive and non-flammable media strictly in accordance with the instructions in this manual.

The DMX 221 dosing pumps have **not** been approved according to the EC directive 94/9/EC, the so-called ATEX directive.

The application of these pumps in potentially explosive environments according to ATEX directive is therefore not permitted.

**Warning**

*Other applications or the operation of pumps in ambient and operating conditions, which are not approved, are considered improper and are not permitted. Grundfos accepts no liability for any damage resulting from incorrect use.*

**1.3 Warranty**

A guarantee claim in accordance with our general terms of sale and delivery is only valid if the following requirements are fulfilled:

- The product is used in accordance with the information within this manual.
- The product is not dismantled or incorrectly handled.
- The maintenance is carried out by authorised and qualified personnel.

**2. Safety**

This manual contains general instructions that must be observed during installation, operation and maintenance of the pump.

This manual must therefore be read by the installation engineer and the relevant qualified personnel/operators prior to installation and start-up, and must be available at the installation location of the pump at all times.

It is not only the general safety instructions given in this "Safety" section that must be observed, but also all the specific safety instructions given in other sections.

**2.1 Identification of safety instructions in this manual**

If the safety instructions or other advice in this manual are not observed, it may result in personal injury or malfunction and damage to the pump. The safety instructions and other advice are identified by the following symbols:

**Warning**

If these safety instructions are not observed, it may result in personal injury!

**Caution**

If these safety instructions are not observed, it may result in malfunction or damage to the equipment!

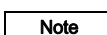
**Note**

Notes or instructions that make the job easier and ensure safe operation.

Information provided directly on the pump, e.g. labelling of fluid connections, must be observed and must be maintained in a readable condition at all times.

## 2.2 Qualification and training of personnel

The personnel responsible for the operation, maintenance, inspection and installation must be appropriately qualified for these tasks. Areas of responsibility, levels of authority and the supervision of the personnel must be precisely defined by the operator.

If the personnel do not have the necessary knowledge, the necessary training and instruction must be given. If necessary, training can be performed by the manufacturer/supplier at the request of the operator of the pump. It is the responsibility of the operator to make sure that the contents of this manual are understood by the personnel.

## 2.3 Risks when safety instructions are not observed

Non-observance of the safety instructions may have dangerous consequences for the personnel, the environment and the pump. If the safety instructions are not observed, all rights to claims for damages may be lost.

Non-observance of the safety instructions may lead to the following hazards:

- failure of important functions of the pump/system
- failure of specified methods for maintenance
- harm to humans from exposure to electrical, mechanical and chemical influences
- damage to the environment from leakage of harmful substances.

## 2.4 Safety-conscious working

The safety instructions in this manual, applicable national health and safety regulations and any operator internal working, operating and safety regulations must be observed.

## 2.5 Safety instructions for the operator/user

Hazardous hot or cold parts on the pump must be protected to prevent accidental contact.

Leakages of dangerous substances (e.g. hot, toxic) must be disposed of in a way that is not harmful to the personnel or the environment. Legal regulations must be observed.

Damage caused by electrical energy must be prevented (for more details, see for example the regulations of the VDE and the local electricity supply company).

## 2.6 Safety instructions for maintenance, inspection and installation work

The operator must ensure that all maintenance, inspection and installation work is carried out by authorised and qualified personnel, who have been adequately trained by reading this manual.

All work on the pump should only be carried out when the pump is stopped. The procedure described in this manual for stopping the pump must be observed.

Pumps or pump units which are used for media that are harmful to health must be decontaminated.

All safety and protective equipment must be immediately restarted or put into operation once work is complete.

Observe the points described in the initial start-up section prior to subsequent start-up.

**Warning**

Electrical connections must only be carried out by qualified personnel!

The pump housing must only be opened by personnel authorised by Grundfos!

## 2.7 Unauthorised modification and manufacture of spare parts

Modification or changes to the pump are only permitted following agreement with the manufacturer. Original spare parts and accessories authorised by the manufacturer are safe to use. Using other parts can result in liability for any resulting consequences.

## 2.8 Improper operating methods

The operational safety of the supplied pump is only ensured if it is used in accordance with section 3. *Technical data*. The specified limit values must under no circumstances be exceeded.

## 2.9 Safety of the system in the event of a failure in the dosing system

DMX 221 dosing pumps are designed according to the latest technologies and are carefully manufactured and tested. However, a failure may occur in the dosing system. Systems in which dosing pumps are installed must be designed in such a way that the safety of the entire system is still ensured following a failure of the dosing pump. Provide the relevant monitoring and control functions for this.

## 3. Technical data

### 3.1 Identification

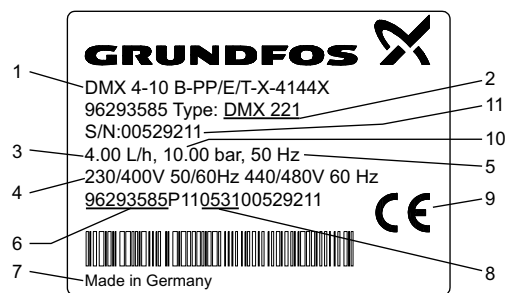

Fig. 1 DMX nameplate

Pos.	Description
1	Type designation
2	Model
3	Maximum capacity [l/h]
4	Voltage [V]
5	Frequency [Hz]
6	Product number
7	Country of origin
8	Year and week code
9	Marks of approval, CE mark, etc.
10	Maximum pressure [bar]
11	Serial number

## 3.2 Type key

Example: **DMX 115 -3 B PP /E /T -X -E 1 QQ X E0**

## Type range

Maximum flow [l/h]

Maximum counterpressure [bar]

## Control variant

B	Standard - manual control
AR**	Analog/pulse control
AT0	Prepared for servomotor
AT3	Servomotor, 1 x 230 V, 50/60 Hz supply, 4-20 mA control
AT5	Servomotor, 1 x 115 V, 50/60 Hz supply, 4-20 mA control
AT8	Servomotor, 1 x 230 V, 50/60 Hz supply, 1 kΩ potentiometer control
AT9	Servomotor, 1 x 115 V, 50/60 Hz supply, 1 kΩ potentiometer control

## Dosing head variant

PP	Polypropylene
PV	PVDF (polyvinylidene fluoride)
PVC	Polyvinyl chloride
SS	Stainless steel 1.4571*
PV-R	PVDF + integrated relief valve
PVC-R	PVC + integrated relief valve
PP-L	PP + integrated diaphragm leakage detection
PV-L	PVDF + integrated diaphragm leakage detection
PVC-L	PVC + integrated diaphragm leakage detection
SS-L	SS + integrated diaphragm leakage detection
PV-RL	PVDF + integrated relief valve and diaphragm leakage detection
PVC-RL	PVC + integrated relief valve and diaphragm leakage detection

## Gasket material

E	EPDM
V	FKM
T	PTFE

## Valve ball material

G	Glass
T	PTFE
SS	Stainless steel 1.4401*

## Control panel position

F	Front-mounted (opposite to the dosing head)
S	Side-mounted (same side as the stroke-length adjustment knob)
Sx	Side-mounted (side opposite to the stroke-length adjustment knob)
W	Wall-mounted
X	No control panel

## Motor variant

E0 PTC motor for frequency control

## Mains plug

F	EU (Schuko)
B	USA, Canada
I	Australia, New Zealand
E	Switzerland
X	No plug

## Connection, suction/discharge

4	Tube 6/9 mm
B1	Tube 6/12 mm/ cementing diameter 12 mm
6	Tube 9/12 mm
B2	Tube 13/20 mm/ cementing diameter 25 mm
Q	Tube 19/27 mm and 25/34 mm
R	Tube 1/4" / 3/8"
S	Tube 3/8" / 1/2"
C5	Hose clamp 1/2"
A	Threaded Rp 1/4
A1	Threaded Rp 3/4
V	Threaded 1/4" NPT, female
A9	Threaded 1/2" NPT, male
A3	Threaded 3/4" NPT, female
A7	Threaded 3/4" NPT, male
B3	Welding, diameter 16 mm
B4	Welding, diameter 25 mm

## Valve type

1	Standard valve
3	Spring-loaded 0.05 bar suction opening pressure 0.8 bar discharge opening pressure
4	Spring-loaded, discharge side only 0.8 bar opening pressure
5	Valve for abrasive media

## Supply voltage

G	1 x 230 V, 50/60 Hz
H	1 x 120 V, 50/60 Hz
E	3 x 230/400 V, 50/60 Hz or 3 x 440/480 V, 60 Hz
F	Without motor, NEMA flange (US)
0	Without motor, IEC flange

\* According to EN 10027-2

\*\* Only pumps up to and including 0.37 kW and only pumps with single-phase motors

### 3.3 Pump performance

#### 3.3.1 Accuracy

- Dosing flow fluctuation:  $\pm 1.5\%$  within the control range 1:10.
- Linearity deviation:  $\pm 4\%$  of the full-scale value.  
Adjustment from max. to min. stroke length, within the control range 1:5.

Applies to:

- water as dosing medium
- fully deaerated dosing head
- measurement according to Grundfos Water Treatment factory standard no. 0010/0011
- standard pump version.

#### 3.3.2 Performance

Applies to:

- maximum counterpressure
- water as dosing medium
- flooded suction 0.5 mWC
- fully deaerated dosing head
- three-phase 400 V motor.

Pump type	Stroke volume V [cm <sup>3</sup> ]	50 Hz			60 Hz				
		Q**	p max.*	Max. stroke rate	Q**	p max.**		Max. stroke rate	
		[l/h]	[bar]*	[n/min]	[l/h]	[US gph]	[bar]*	[psi]*	[n/min]
DMX 4-10	2.2	4	10	29	5	1.3	10	145	35
DMX 7-10	3.8	7	10	29	8	2.1	10	145	35
DMX 9-10	4.9	9	10	29	11	2.9	10	145	35
DMX 12-10	6.9	12	10	29	14	3.7	10	145	35
DMX 17-4	10.4	17	4	29	20	5.3	4	58	35
DMX 25-3	16	27	3	29	32	8.5	3	43	35
DMX 7.2-16**	1.9	7.2	16	63	10	2.6	16	232	75
DMX 8-10	2.2	8	10	63	10	2.6	10	145	75
DMX 14-10	3.8	14	10	63	17	4.5	10	145	75
DMX 18-10	4.9	18	10	63	22	5.8	10	145	75
DMX 26-10	6.9	26	10	63	31	8.2	10	145	75
DMX 39-4	10.4	39	4	63	47	12.4	4	58	75
DMX 60-3	16	60	3	63	72	19.0	3	43	75
DMX 13.7-16**	1.9	13.7	16	120	19	5.0	16	232	144
DMX 16-10	2.2	16	10	120	19	5.0	10	145	144
DMX 27-10	3.8	27	10	120	32	8.5	10	145	144
DMX 35-10	4.9	35	10	120	42	11.1	10	145	144
DMX 50-10	6.9	50	10	120	60	15.8	8	116	144
DMX 75-4	10.4	75	4	120	90	23.8	3.5	50	144
DMX 115-3	16	115	3	120	138	36.5	2.5	36	144

\* Maximum counterpressure

\*\* When operating with a counterpressure of 16 bar, the life of the dosing diaphragm will be reduced.

### 3.4 Suction heights

#### 3.4.1 Media with a viscosity similar to water

Applies to:

- counterpressure of 1.5 to 3 bar
- non-degassing and non-abrasive media
- temperature of 20 °C
- stroke length 100 %.

Pump type	50 Hz		60 Hz		Maximum length of suction line [m]
	Suction height* [mWC]	Intake height** [mWC]	Suction height* [mWC]	Intake height** [mWC]	
DMX 4-10	4	4	4	4	5
DMX 7-10	4	4	4	4	5
DMX 9-10	3	3	3	3	4
DMX 12-10	3	2.5	3	2.5	4
DMX 17-4	1	1	1	1	2
DMX 25-3	1	1	1	1	2
DMX 7.2-16	4	3	4	3	5
DMX 8-10	4	4	4	4	5
DMX 14-10	4	3	4	4	5
DMX 18-10	3	3	3	3	4
DMX 26-10	3	2.5	3	2.5	4
DMX 39-4	1	1	1	1	2
DMX 60-3	1	1	1	1	2
DMX 13.7-16	4	3	3.5	2.5	5
DMX 16-10	4	3	3.5	2.5	5
DMX 27-10	4	3	3.5	2.5	5
DMX 35-10	3	2	2.5	2	4
DMX 50-10	3	2	2.5	1.5	4
DMX 75-4	1	1	0.5	0.5	2
DMX 115-3	1	1	0.5	0.5	2

\* Suction line and dosing head filled (continuous operation).

\*\* Suction line and dosing head not filled, but dosing head and valves moistened (start-up).



### 3.4.2 Suction heights for media with maximum permissible viscosity

Applies to:

- Newtonian liquids
- non-degassing and non-abrasive media
- temperature of 20 °C.

Pump type	Maximum viscosity [mPa s]	Intake height [mWC]
DMX 4-10	400	1
DMX 7-10	400	1
DMX 9-10	200	1
DMX 12-10	200	1
DMX 17-4	200	1 mWC flooded suction
DMX 25-3	200	1 mWC flooded suction
DMX 7.2-16	400	1
DMX 8-10	400	1
DMX 14-10	400	1
DMX 18-10	200	1
DMX 26-10	200	1 mWC flooded suction
DMX 39-4	100	1
DMX 60-3	100	1
DMX 13.7-16	200	1
DMX 16-10	200	1
DMX 27-10	200	1
DMX 35-10	100	1
DMX 50-10	100	1
DMX 75-4	100	1 mWC flooded suction
DMX 115-3	100	1 mWC flooded suction

### 3.5 Ambient and operating conditions

- Permissible ambient temperature: 0 °C to +40 °C.
- Permissible storage temperature: -20 °C to +50 °C.
- Permissible air humidity: max. relative humidity: 70 % at 40 °C, 90 % at 35 °C.

**The installation site must be under cover!  
Ensure that the enclosure class of motor and pump are not affected by the atmospheric conditions.**

**Caution**

**Pumps with electronics are only suitable for indoor use! Do not install outdoors!**

#### Warning

**Risk of hot surfaces!**

**Pumps with AC motors may become hot.  
Allow a minimum space of 100 mm above the fan cover!**



- Sound pressure level: ± 55 dB(A), testing according to DIN 45635-01-KL3.
- Minimum counterpressure: 1 bar at the pump discharge valve. Pay attention to the pressure losses along the way to the injection point inclusively.

#### Pumps with AR control unit only

Maximum permissible mains impedance:  $0.084 + j 0.084 \Omega$  (testing according to EN 61000-3-11).

### 3.6 Dosing medium

**In the event of questions regarding the material resistance and suitability of the pump for specific dosing media, please contact Grundfos.**

**Caution**

The dosing medium must have the following basic characteristics:

- liquid
- non-abrasive
- non-flammable.

#### 3.6.1 Permissible media temperature

Dosing head material	Temperature range	
	p < 10 bar	p < 16 bar
PVC	0 °C to 40 °C	0 °C to 20 °C
Stainless steel*	-10 °C to 70 °C	-10 °C to 70 °C
PP	0 °C to 40 °C	-
PVDF	-10 °C to 60 °C	-10 °C to 20 °C
	70 °C at 9 bar	

\* For SIP/CIP applications: A temperature of 145 °C at a counterpressure of max. 2 bar is permitted for a short period (15 minutes).

**Caution**

**Observe the freezing and boiling points of the dosing medium!**

### 3.7 Electrical data

#### 3.7.1 Enclosure class

The enclosure class depends on the motor variant selected, see motor nameplate.

The specified enclosure class can only be ensured if the power supply cable is connected with the same degree of protection.

Pumps with electronics: The enclosure class is only met if the sockets are protected! The data regarding the enclosure class applies to pumps with correctly inserted plugs or screwed-on caps.

#### 3.7.2 Motor

Version: see motor and pump nameplates.

### 3.8 AR control unit

Functions of pumps with electronics:

- "Continuous operation" button for function test and dosing head deaeration
- memory function (stores a maximum of 65000 pulses)
- two-stage tank-empty signal (e.g. via Grundfos tank empty sensor)
- stroke signal/pre-empty signal (adjustable), e.g. as a feedback to the control room
- dosing controller function (only with sensor - optional)
- diaphragm leakage detection (only with sensor - optional)
- access-code-protected settings
- remote on/off
- Hall sensor
- operating hours counter
- motor monitoring.

Operating modes:

- manual  
Stroke frequency: manually adjustable between zero and maximum
- contact signal control  
Multiplier (1:n) and divisor (n:1)
- current signal control 0-20 mA / 4-20 mA  
Adjustment of stroke frequency proportional to the current signal.  
Weighting of current input.

### 3.8.1 Inputs and outputs

Inputs	
Contact signal	Maximum load: 12 V, 5 mA
Current 0-20 mA	Maximum load: 22 Ω
Remote on/off	Maximum load: 12 V, 5 mA
Two-stage tank-empty signal	Maximum load: 12 V, 5 mA
Dosing controller and diaphragm leakage sensor	
Outputs	
Current 0-20 mA	Maximum load: 350 Ω
Error signal	Maximum ohmic load: 50 VDC / 75 VAC, 0.5 A
Stroke signal	Contact time/stroke: 200 ms
Pre-empty signal	Maximum ohmic load: 50 VDC / 75 VAC, 0.5 A

#### AR control unit factory settings

- Inputs and outputs: NO (normally open)  
or
- inputs and outputs: NC (normally closed).

### 3.9 Materials

- Upper part of enclosure: PPO blend
- Lower part of enclosure: PP, glass-fibre-reinforced
- Stroke-length adjustment knob: ABS.

#### AR control unit enclosure

- Upper part of enclosure: PPO blend
- Lower part of enclosure: aluminium.

### 3.10 Weights

Pump type	Weight	
	Plastics [kg]	Stainless steel [kg]
DMX 4-10	5	7
DMX 7-10	5	7
DMX 9-10	5	7
DMX 12-10	5	7
DMX 17-4	7.5	12
DMX 25-3	8	13
DMX 7.2-16	5	7
DMX 8-10	5	7
DMX 14-10	5	7
DMX 18-10	5	7
DMX 26-10	5	7
DMX 39-4	7.5	12
DMX 60-3	8	13
DMX 13.7-16	5	7
DMX 16-10	5	7
DMX 27-10	5	7
DMX 35-10	5	7
DMX 50-10	5	7
DMX 75-4	7.5	12
DMX 115-3	8	13

3.11 Dimensional sketches

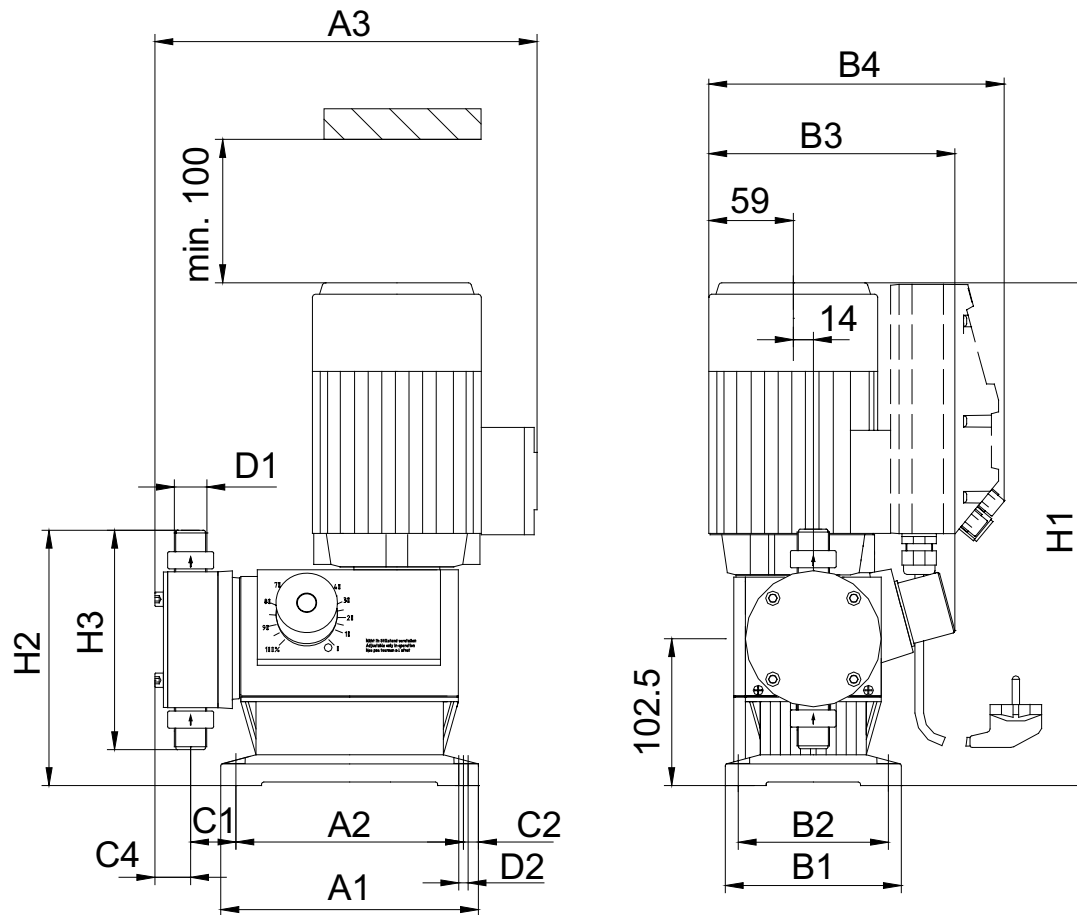

Fig. 2 Dimensional sketches of DMX 221

TM03 6295 1612

Pump type	A1	A2	A3	B1	B2	B3	B4	C1	C2	C4	D1	D2	H1	H2	H3
DMX 4-10	180	159	275	123	105	175	205	32	10.5	25	R 5/8	6.5	319	179	153
DMX 7-10	180	159	275	123	105	175	205	32	10.5	25	R 5/8	6.5	319	179	153
DMX 7.2-16	180	159	275	123	105	175	205	32	10.5	25	R 5/8	6.5	319	179	153
DMX 9-10	180	159	275	123	105	175	205	32	10.5	25	R 5/8	6.5	319	179	153
DMX 12-10	180	159	275	123	105	175	205	32	10.5	25	R 5/8	6.5	319	179	153
DMX 17-4	180	159	323	123	105	175	205	64	10.5	38	R 1 1/4	6.5	319	192	177
DMX 25-3	180	159	330	123	105	175	205	80	10.5	40	R 1 1/4	6.5	319	197	188
DMX 8-10	180	159	275	123	105	175	205	32	10.5	25	R 5/8	6.5	319	179	153
DMX 13.7-16	180	159	275	123	105	175	205	32	10.5	25	R 5/8	6.5	319	179	153
DMX 14-10	180	159	275	123	105	175	205	32	10.5	25	R 5/8	6.5	319	179	153
DMX 18-10	180	159	275	123	105	175	205	32	10.5	25	R 5/8	6.5	319	179	153
DMX 26-10	180	159	275	123	105	175	205	32	10.5	25	R 5/8	6.5	319	179	153
DMX 39-4	180	159	323	123	105	175	205	64	10.5	38	R 1 1/4	6.5	319	192	177
DMX 60-3	180	159	330	123	105	175	205	80	10.5	40	R 1 1/4	6.5	319	197	188
DMX 16-10	180	159	275	123	105	175	205	32	10.5	25	R 5/8	6.5	319	179	153
DMX 27-10	180	159	275	123	105	175	205	32	10.5	25	R 5/8	6.5	319	179	153
DMX 35-10	180	159	275	123	105	175	205	32	10.5	25	R 5/8	6.5	319	179	153
DMX 50-10	180	159	275	123	105	175	205	32	10.5	25	R 5/8	6.5	319	179	153
DMX 75-4	180	159	323	123	105	175	205	64	10.5	38	R 1 1/4	6.5	319	192	177
DMX 115-3	180	159	330	123	105	175	205	80	10.5	40	R 1 1/4	6.5	319	197	188

Measurements in mm.

## 4. Transport and storage

*Do not throw or drop the pump.*

*Store the pump in a dry and cool place.*

*Store the pump in upright position so that the gear grease cannot leak out.*

Caution

*Do not use the protective packaging as transport packaging.*

*Observe the permissible storage temperature!*

### 4.1 Delivery

The DMX 221 dosing pumps are supplied in different packaging, depending on pump type and the overall delivery. For transport and intermediate storage, use the correct packaging to protect the pump against damage.

### 4.2 Intermediate storage

- Permissible storage temperature: -20 °C to +50 °C.
- Permissible air humidity: max. relative humidity: 92 % (non-condensing).

### 4.3 Unpacking

Retain the packaging for future storage or return, or dispose of the packaging in accordance with local regulations.

### 4.4 Return

Return the pump in its original packaging or equivalent.

The pump must be thoroughly cleaned before it is returned or stored. It is essential that there are no traces of toxic or hazardous media remaining on the pump.

***Grundfos accepts no liability for damage caused by incorrect transportation or missing or unsuitable packaging of the pump!***

Caution

Before returning the pump to Grundfos for service, the **safety declaration** at the end of these instructions must be filled in by authorised personnel and attached to the pump in a visible position.

***If a pump has been used for a medium which is injurious to health or toxic, the pump will be classified as contaminated.***

Caution

If Grundfos is requested to service the pump, it must be ensured that the pump is free from substances that can be injurious to health or toxic. If the pump has been used for such substances, the pump must be cleaned before it is returned.

If proper cleaning is not possible, all relevant information about the chemical must be provided.

If the above is not fulfilled, Grundfos can refuse to accept the pump for service. Possible costs of returning the pump are paid by the customer.

The safety declaration can be found at the end of these instructions.

***The replacement of the supply cable must be carried out by an authorised Grundfos service workshop.***

Caution

## 5. Installation

### 5.1 Optimum installation

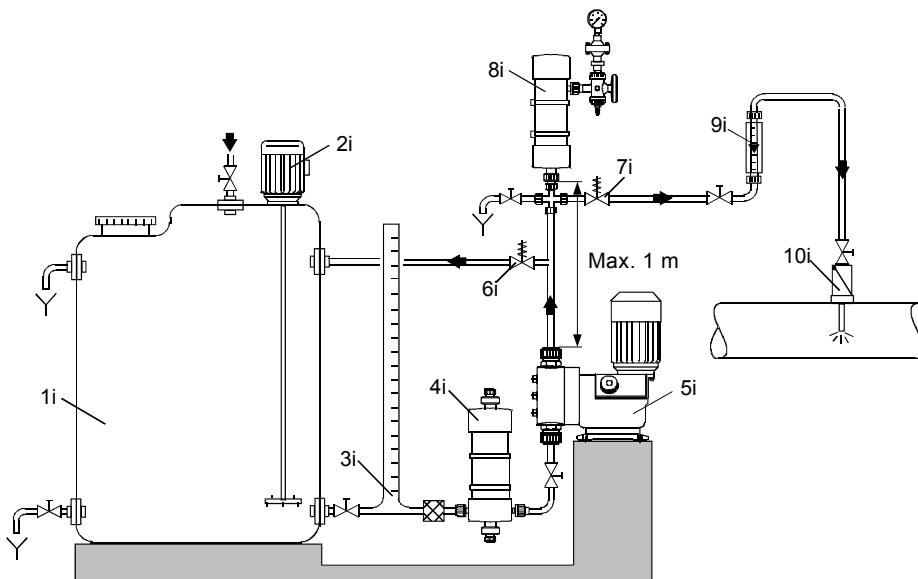

Fig. 3 Example of optimum installation

Pos.	Components
1i	Dosing tank
2i	Electric agitator
3i	Extraction device
4i	Suction pulsation damper
5i	Dosing pump
6i	Relief valve
7i	Pressure-loading valve
8i	Pulsation damper
9i	Measuring glass
10i	Injection unit

- For non-degassing media with a viscosity similar to water, the pump can be mounted on the tank (observe the maximum suction height).
- Flooded suction preferred.
- For media with a tendency to sedimentation, install the suction line with filter (13i) so that the suction valve remains a few millimetres above the possible level of sedimentation.

### 5.2 Installation tips

- For easy deaeration of the dosing head, install a ball valve (11i) with bypass line (back to the dosing tank) immediately after the discharge valve.
- In the case of long discharge lines, install a non-return valve (12i) in the discharge line.

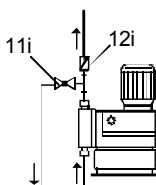

Fig. 4 Installation with ball valve and non-return valve

- When installing the suction line, observe the following:
  - Keep the suction line as short as possible. Prevent it from becoming tangled.
  - If necessary, use swept bends instead of elbows.
  - Always route the suction line up towards the suction valve.
  - Avoid loops which may cause air bubbles.

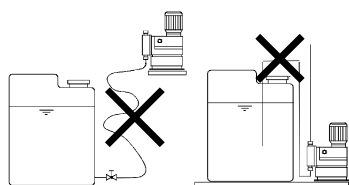

Fig. 5 Installation of suction line

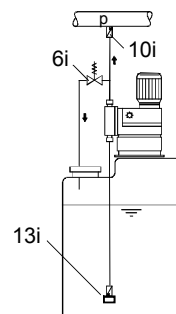

Fig. 6 Tank installation

- Note for suction-side installation: In dosing systems with a suction line longer than 1 metre, depending on the dosing flow, it may be necessary to install a properly sized pulsation damper (4i) immediately before the pump suction valve.

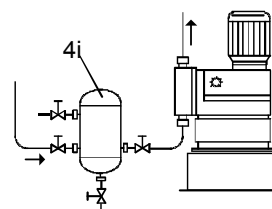

Fig. 7 Installation with suction-side pulsation damper

TM03 6296 4506

TM03 6299 4506

TM03 6297 4506

TM03 6298 4506

TM03 6300 4506

- Note for discharge-side installation: To protect the piping, use a pulsation damper (8i) for rigid piping longer than 3 metres and tubing longer than 5 metres.

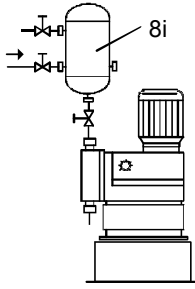

Fig. 8 Installation with discharge-side pulsation damper

- For degassing and viscous media: flooded suction.
- To protect the dosing pump and the discharge line against excessive pressure build-up, install a relief valve (6i) in the discharge line.

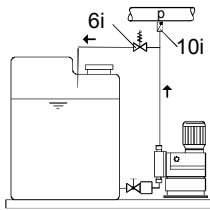

Fig. 9 Installation with relief valve

**With open outflow of the dosing medium or a counterpressure below 1 bar**

- Install a pressure-loading valve (7i) immediately before the outlet or the injection unit.
- A positive pressure difference of at least 1 bar must be ensured between the counterpressure at the injection point and the pressure of the dosing medium at the pump suction valve.
- If this cannot be ensured, install a pressure-loading valve (7i) in the discharge line.

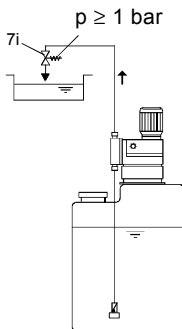

Fig. 10 Installation with pressure-loading valve

- To avoid the siphon effect, install a pressure-loading valve (7i) in the discharge line and, if necessary, a solenoid valve (14i) in the suction line.

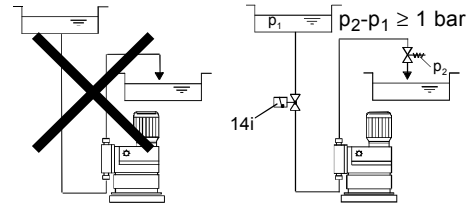

Fig. 11 Installation to avoid the siphon effect



**Warning**

**Risk of hot surfaces!**

**Pumps with AC motors may become hot. Allow a minimum space of 100 mm to the fan cover!**

**5.3 Mounting**

- Mount the pump horizontally on the tank or on a console using four M6 screws.



**Gently tighten the screws in order not to damage the plastic enclosure!**

**5.4 Hose / pipe lines**

**5.4.1 General**



**Warning**

**To protect the dosing pump against excessive pressure build-up, install a relief valve in the discharge line.**

**Only use the prescribed line types!**

**All lines must be free from strain!**

**Avoid loops and buckles in the hoses!**

**Keep the suction line as short as possible to avoid cavitation!**

**If necessary, use swept bends instead of elbows.**

**Observe the chemical manufacturer's safety instructions when handling chemicals!**

**Make sure that the pump is suitable for the actual dosing medium!**

**The flow must run in the opposite direction to gravity!**

**The resistance of the parts that come into contact with the media depends on the media, media temperature and operating pressure. Ensure that parts in contact with the media are chemically resistant to the dosing medium under operating conditions!**

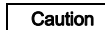

**5.5 Connecting the suction and discharge lines**



**Warning**

**All lines must be free from strain!**

**Only use the prescribed line types!**

- Connect the suction line to the suction valve.
  - Install the suction line in the tank so that the foot valve remains 5 to 10 mm above the bottom of the tank or the possible level of sedimentation.
- Connect the discharge line to the discharge valve.

TM03 6301 4506

TM03 6302 4506

TM03 6303 4506

TM03 6304 4506

### Connection of hose lines

- Push the hose firmly onto the connection nipple and, depending on the connection, secure using a connection counterpart or hose support clip.
- Fit the gasket.
- Screw onto the valve using the union nut.

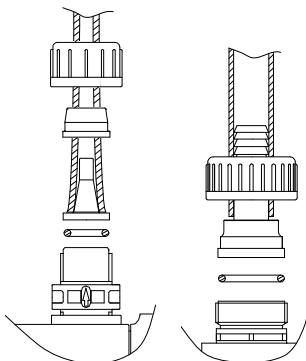

Fig. 12 Connection of hose lines

### Connection of DN 20 pipe lines

- Depending on the pipe material and connection, glue it (PVC), weld it (PP, PVDF or stainless steel) or press it in (stainless steel).
- Fit the gasket.
- Screw onto the valve using the union nut.

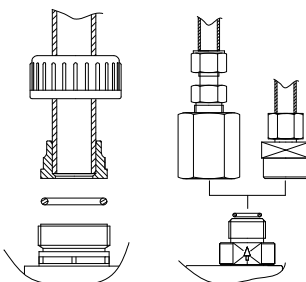

Fig. 13 Connection of DN 20 pipe lines

### Using a dosing controller

- Screw the dosing controller onto the discharge valve.
- Connect the discharge line to the dosing controller.

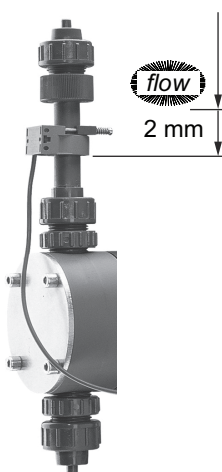

Fig. 14 Dosing controller

## 6. Electrical connections

Make sure that the pump is suitable for the electricity supply on which it will be used.



### Warning

**Electrical connections must only be carried out by qualified personnel!**

**Disconnect the power supply before connecting the power supply cable and the relay contacts!**

**Observe the local safety regulations!**



### Warning

**The pump housing must only be opened by personnel authorised by Grundfos!**



### Warning

**Protect the cable connections and plugs against corrosion and humidity.**

**Only remove the protective caps from the sockets that are being used.**

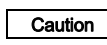

### Caution

**The power supply must be electrically isolated from the signal inputs and outputs.**

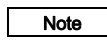

### Note

**The pump is switched off by switching off the power supply.**

**Do not switch on the power supply until the pump is going to be started.**

### 6.1 Versions with mains plug

- Insert the mains plug in the mains socket.

### 6.2 Versions without mains plug

- Connect the motor according to the wiring diagram in the terminal box.

**Observe the direction of rotation!**

**A motor protector, adjusted to the rated motor current, must be provided by the customer. This is also necessary for versions with AR control unit!**

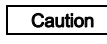

### Caution

**When the pump is used with a frequency converter, the jumpers in the terminal box have to be set according to the converter voltage.**

**The jumpers of three-phase motors are factory-set for star connection.**

TM03 6456 4506

TM03 6457 4506

TM03 6379 0911

## 7. Commissioning

### 7.1 Checks before start-up

- Check that the rated voltage stated on the pump nameplate corresponds to the local conditions!
- Check that all connections are secure and tighten, if necessary.
- Check that the dosing head screws are tightened with the specified torque and tighten, if necessary.
- Check that all electrical connections are correct.

### 7.2 Start-up

**Before start-up, open the venting cartridge (pull cap approx. 5 mm).**

**Caution**

**For transport or cleaning, the venting cartridge must be closed.**

**After initial start-up and after each time the diaphragm is changed, tighten the dosing head screws.**

**Caution**

**After approximately 6-10 operating hours or two days, cross-tighten the dosing head screws using a torque wrench.**

**Maximum torque: 6 Nm.**

1. Open the suction and discharge isolating valves (15, 16), if installed.
2. Open the deaeration valve (17), if installed, in the discharge line, or relieve the pressure on the discharge side so that the medium can run out without a counterpressure.
3. Switch on the power supply.
4. Pumps with AR control unit only: Press the "Start/Stop" button and keep it pressed.
  - The pump switches to continuous operation.
5. Set the stroke-length adjustment knob to 100 %.
6. Leave the pump running until the dosed medium is free of air bubbles.
7. Close the deaeration valve (17), if installed.
  - The pump is now ready for operation.

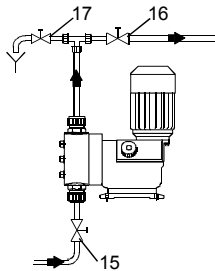

Fig. 15 Initial start-up

TM03 6307 4506

## 8. Operation

**In the event of a diaphragm leakage, the dosing liquid may leak out of the hole in the intermediate flange between the pump and the dosing head. The parts inside the housing are protected from the dosing liquid for a short time (depending on the type of liquid) by the housing sealing. It is necessary to check regularly (daily) if liquid is leaking out of the intermediate flange. For maximum safety, we recommend the pump version with diaphragm leakage detection.**

**Caution**

### 8.1 Description of the pump

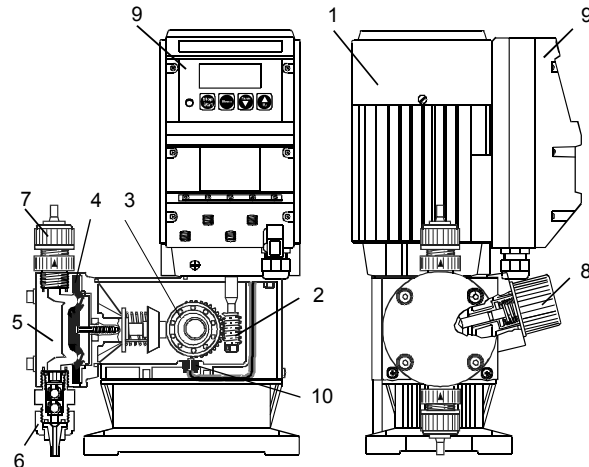

TM03 6308 4506

Fig. 16 DMX 221

Pos.	Components
1	Motor
2	Gears
3	Eccentric
4	Dosing diaphragm
5	Dosing head
6	Suction valve
7	Discharge valve
8	Stroke-length adjustment knob
9	AR control unit (optional)
10	Stroke sensor

#### Functional principle

- Reciprocating positive displacement pump with electric motor and mechanical diaphragm control.
- The rotation of the motor is transformed into the reciprocating movement of the dosing diaphragm by the eccentric and the tappet.
- The dosing flow can be set by adjusting the stroke length of the tappet.

### 8.2 Switching on/off

**Caution**

**Before switching on the pump, check that it is installed correctly. Refer to sections 5. Installation and 7. Commissioning.**

- To start the pump, switch on the power supply.
- To stop the pump, switch off the power supply.



### 8.3 Adjusting the dosing flow via the stroke length

**Caution** *Adjust the stroke length only while the pump is running!*

- To increase the dosing flow, turn the stroke-length adjustment knob (8) slowly to the left until the desired dosing flow is reached.
- To decrease the dosing flow, turn the stroke-length adjustment knob (8) slowly to the right until the desired dosing flow is reached.

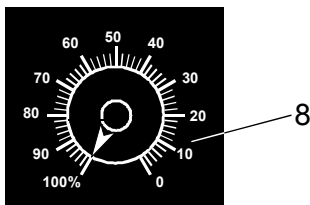

Fig. 17 Stroke-length adjustment knob

### 8.4 Stroke-length adjustment



#### Warning

**Wear protective clothing (gloves and goggles) when working on the dosing head, connections or lines!**

**Caution** *Adjust the stroke length only while the pump is running!*

The zero point (no dosing) of the dosing pump is factory-set to a counterpressure of 3 bar. See section 13. *Dosing curves*.

If the operating counterpressure at the injection unit deviates considerably from this value, it is advisable to readjust the zero point to obtain more precise values.

1. Install a graduated pipe at the suction valve.
  - If such a pipe is not available, insert the suction line into a graduated measuring jug.
2. Start the dosing pump.
3. Set the dosing flow to 15 %.
4. For pumps with tank-empty indication, remove the electric plug of the tank-empty indication.
5. Turn the adjustment knob slowly clockwise (towards the zero point) until the medium level stops falling in the measuring jug or pipe.
6. Remove the plug with a small screwdriver without changing the position of the adjustment knob and unscrew the cheese-head screw together with the flat spiral spring.
7. Gently pull off the adjustment knob and fit it on the adjusting spindle so that the zero line on the scale and the mark on the adjustment knob coincide.
8. Screw in the cheese-head screw and the spiral spring until the spring is preloaded, but does not block. Even when adjusted to 100 %, the spring of the adjustment knob must remain preloaded.

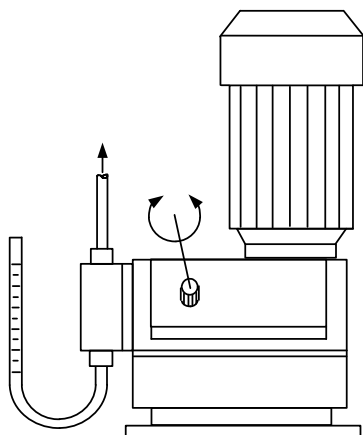

Fig. 18 Stroke-length adjustment

### 8.5 Adjustment of stroke rate using a frequency converter

If a frequency converter is connected, the stroke rate can only be adjusted in the range 10-100 % of max. stroke rate. See installation and operating instructions for the frequency converter!



#### Warning

**Observe the manufacturer's instructions! The connections must be carried out according to these instructions.**

#### Settings of frequency converter when used with Grundfos dosing pumps

Pay special attention to the following parameters of the frequency converter:

- P013 (maximum motor frequency):
  - Set the frequency converter to maximum 100 Hz.
  - Due to this setting, the maximum stroke frequency of the pump cannot be exceeded.
- P086 (motor current limit):
  - Do not change the default setting (150 %).
  - The motor is protected by a PTC resistor. Therefore, this parameter is not necessary.
- P081 - P085 (motor data):
  - Set these parameters to the values stated on the motor nameplate.
  - Observe the manufacturer's instructions!

### 8.6 Using the AR control unit

When using the AR control unit, observe the installation and operating instructions supplied with the unit in addition to the instructions in this manual.

## 9. Operation with other electronics

#### Caution

**First refer to the general section 8. Operation. This section only describes the additional functions.**

### 9.1 Electronics version stroke sensor

Pump type with inductive-proximity switch of two-wire design according to NAMUR DIN 19234 for signalling the strokes.

The sensor can be installed in potentially explosive atmospheres if PTB-approved isolating switching amplifiers with an intrinsically safe control circuit [EExia] or [EExib] are connected. The sensor can be used up to zone 1 depending on the isolating amplifier. The specifications in the declaration of conformity for the isolating amplifier must be observed.

Supply voltage  $U_B$ : 7.7 to 10 V.

TM03 6309 4506

TM03 6310 4506

## 9.2 Electronic diaphragm leakage sensor

### 9.2.1 Technical data

Model 230 V (+ 10 %/- 10 %)

Model 115 V (+ 10 %/- 10 %)

- Contact load: 250 V / 6 A, max. 550 VA
- Power consumption: 1.15 VA
- Enclosure class: IP65
- Permissible temperature range: 0 °C to +40 °C.

### 9.2.2 Dimensional sketch (electronics enclosure)

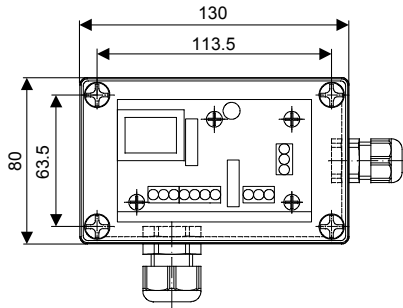

Fig. 19 Electronics enclosure

### 9.2.3 Function

Pumps prepared for diaphragm leakage detection:

- Special dosing head flange for inserting the optoelectronic sensor
- The optoelectronic sensor contains
  - infrared sender
  - infrared receiver.

#### In case of a leaking diaphragm

- The dosing liquid penetrates the dosing head flange.
  - The light refraction will be changed.
- The sensor produces a signal.
  - The electronics switches two contacts. These contacts can for instance be used to trigger an alarm device or to switch off the pump.

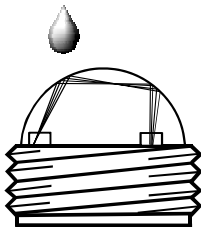

Fig. 20 Diaphragm leakage sensor

### 9.2.4 Electrical connection of the electronics

#### Warning

**Electrical connections must only be carried out by qualified personnel!**

**Disconnect the power supply before connecting the power supply cable and the relay contacts!**

**Observe the local safety regulations!**

**Protect the cable connections and plugs from corrosion and moisture.**

**Before connecting the power supply cable, check that the supply voltage stated on the pump nameplate corresponds to the local electricity supply. An incorrect power supply could destroy the unit!**

Caution

To ensure electromagnetic compatibility (EMC), the input cables and current output cables must be screened.

1. Connect the screen at one end to PE.
  - Refer to the connection diagram!
2. Route input cables, current output cables and power supply cables in separate ducts.
3. Connect the device to the power supply according to the connection diagram.
4. Connect the electronics with the sensor according to the connection diagram.



#### Warning

**The potential-loaded contact 1, terminals 6 and 7, is loaded with supply voltage.**

**Switch off the power supply before connecting contact 1!**

**The contacts have no protective circuits.**

**Only pure ohmic loads may be switched.**

**For switching the pump motor, a contactor has to be connected inbetween.**

Caution

5. Connect contacts 1 and 2 according to individual needs. See section 6. *Electrical connections.*

### 9.2.5 Relay outputs

Note

**The relay output connection depends on the application and the connected actuators.**

- Interference suppression is required for inductive loads (also relays and contactors).
- If this is not possible, protect the relay contacts using a suppressor circuit as described below.

#### With AC voltage

Current up to	Capacitor C	Resistor R
60 mA	10 $\mu$ F, 275 V	390 $\Omega$ , 2 W
70 mA	47 $\mu$ F, 275 V	22 $\Omega$ , 2 W
150 mA	100 $\mu$ F, 275 V	47 $\Omega$ , 2 W
1.0 A	220 $\mu$ F, 275 V	47 $\Omega$ , 2 W

#### With DC voltage

- Connect the free-wheeling diode parallel to the relay or contactor.

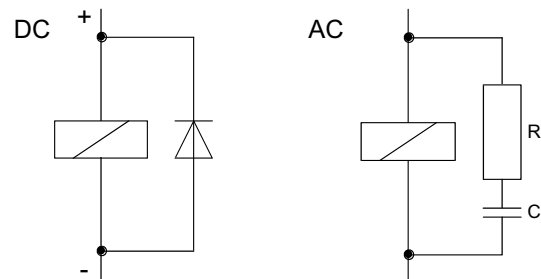

Fig. 21 Suppressor circuit DC/AC

Caution

**Provide relay outputs on site with an appropriate back-up fuse!**

Note

**These connections depend on the type of actuator used and should only be understood as guidelines. Refer to actuator documentation.**

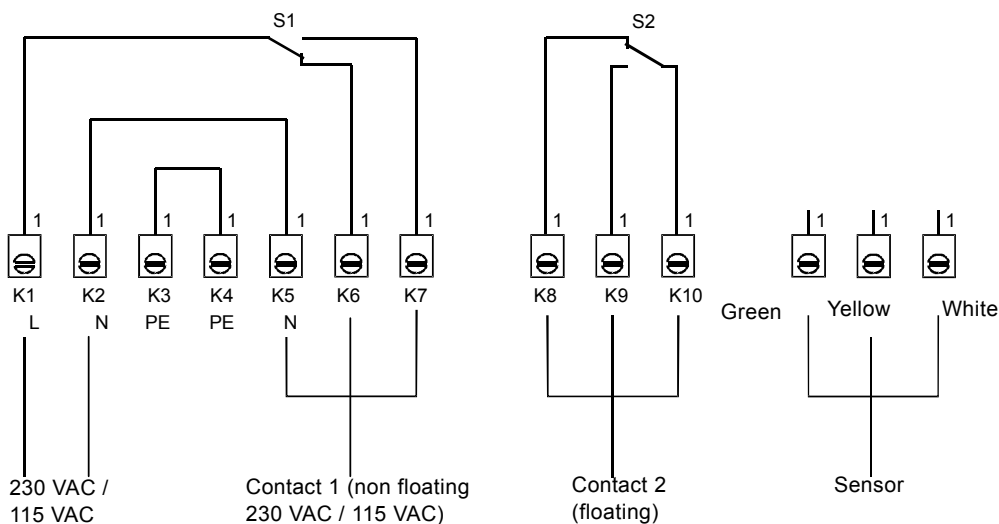

Fig. 22 Electrical connection of the electronics

### 9.2.6 Screwing the sensor into the dosing head

- Screw the sensor from the lower side into the hole of the dosing head flange (M14 x 1.5).
  - Now the diaphragm leakage sensor is ready for start-up.

### 9.2.7 Start-up

**Caution** Carry out a functional check before start-up!

#### Functional check

- Dip the sensor into water.
  - Green and red LEDs are on:  
Sensor and electronics are ready for operation!
  - One or more LEDs are off:  
Sensor or electronics is defective!  
Call Grundfos service.
- Carefully dry the sensor.
  - Only the green LED is still on:  
Sensor and electronics are ready for operation!
  - The red LED is still on:  
Sensor or electronics is defective!  
Call Grundfos service.



#### Warning

**Do not open the electronics or sensor!**  
**Repairs must only be carried out by authorised and qualified personnel!**

### 9.2.8 Using the contacts

- Terminals 6 and 7 (potential-loaded)
  - for instance for switching off the pump in case of a diaphragm leakage.
- Terminals 8, 9 and 10 (potential-free)
  - for instance for triggering an alarm device.

### 9.2.9 Description of the device

There are a green and a red light-emitting diode (LED) at the electronics.

- Green LED
  - shows that the system is ready for operation.
  - The LED is only on when the sensor is connected to the electronics.  
If the LED is off in this case, either the sensor or the cable is defective or wrongly connected.
- Red LED
  - shows that a diaphragm leakage has been detected.
  - The green LED is still on.

### 9.2.10 Maintenance



#### Warning

**Do not open the electronics or sensor!**  
**Repairs must only be carried out by authorised and qualified personnel!**

#### Sensor

Optoelectronic sensor with 3 metres cable.

- Clean the sensor in case of malfunction.
- If the sensor still does not operate correctly, replace it.

#### Electronics

- No maintenance is possible by the user.
- If the electronics does not operate correctly, call Grundfos service.

## 10. Integral relief valve

### 10.1 Function

If the pump is the only pump in the system, the integral relief valve (optional) protects the complete discharge side of the discharge line system from an excessive pressure build-up.

The valve opens if the pressure rises above its set opening pressure, and the dosing medium can return to the dosing tank. In contrast to relief valves connected in series, the integral valve also provides pump protection if the discharge valve is dirty or blocked.

### 10.2 Permissible media



#### Warning

**Dosing heads with integral relief valve must not be used for abrasive or crystallising media.**

### 10.3 Connections

1. Connect the suction line to the suction valve (A).
2. Connect the discharge line to the discharge valve (B).
3. Connect the overflow line to the relief valve (C) and allow the medium to flow by gravity into the tank or to an appropriate overflow.

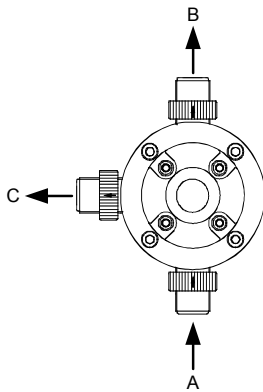

Fig. 23 Connections



#### Warning

**Never start the pump if the overflow line is not correctly connected to the relief valve.**

### 10.4 Setting of opening pressure

#### 10.4.1 General

The opening pressure can only be set if a pressure gauge is installed in the system between the pump and the next isolating valve or pressure-loading valve.



#### Warning

**Settings on the relief valve must only be carried out by authorised and qualified personnel!**

The opening pressure of the relief valve is factory-set to the maximum pump counterpressure specified in the technical data. The opening pressure during operation depends on various factors, e.g. the flow, the stroke frequency of the pump, or the counterpressure. If an exact setting is required, the relief valve must be adapted to the local conditions.



#### Warning

**Never set the opening pressure to values higher than the maximum permissible operating pressure of the dosing system and dosing pump.**



#### Warning

**When dosing dangerous media, observe the corresponding safety precautions!**

**Wear protective clothing (gloves and goggles) when working on the dosing head, connections or lines!**

#### 10.4.2 Setting the valve opening pressure

To change the factory-set opening pressure, proceed as follows: The pump must be running.

1. Remove the cap from the top part of the relief valve.
2. Close the isolating valve after the pressure gauge.
3. When overflowing of the dosing medium is heard, read the current opening pressure on the pressure gauge.

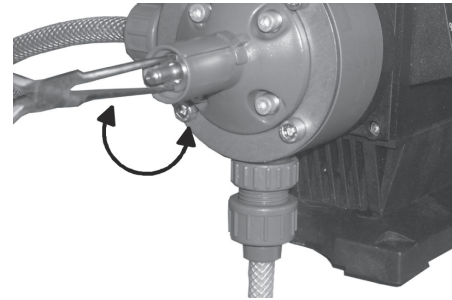

Fig. 24 Setting of opening pressure

4. Change the pressure as follows:
  - To increase the pressure, turn the knob clockwise using pointed pliers until the desired opening pressure is reached.
  - To reduce the pressure, turn the knob counter-clockwise using pointed pliers until the desired opening pressure is reached.
5. Open the isolating valve after the pressure gauge.
6. Refit the cap.

### 10.5 Venting

The relief valve can also be opened manually, thus serving as a venting valve at the same time. If manual venting is required (e.g. during start-up or when the tank has been replaced), proceed as follows:

- Turn the knob so that the smaller cut-out rests on the nub of the dosing head (the rotary knob is then further away from the dosing head). The valve spring is unloaded (position B).
- Once the pump has been completely vented, turn the knob back into position A "Operating".

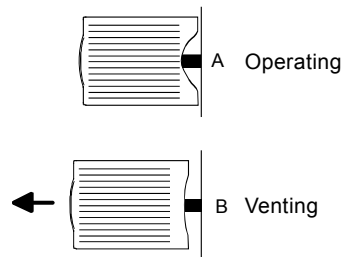

Fig. 25 Knob position

TM03 6312 4506

TM03 6311 4506

TM03 6313 4506

## 10.6 Fault finding chart

Fault	Cause	Remedy
Permanent output from the relief valve.	Discharge line blocked.	Check and possibly correct the discharge-side dosing system.
	Relief valve incorrectly set (too low).	Set the relief valve to a higher opening pressure.
	Diaphragm faulty.	Replace the diaphragm.
	Relief valve dirty.	Clean the relief valve.

## 11. Maintenance

### 11.1 General notes

#### Warning

**When dosing dangerous media, observe the corresponding safety precautions!**

#### Risk of chemical burns!

**Wear protective clothing (gloves and goggles) when working on the dosing head, connections or lines!**

**Do not allow any chemicals to leak from the pump. Collect and dispose of all chemicals correctly!**

#### Warning

**The pump housing must only be opened by personnel authorised by Grundfos!**

**Repairs must only be carried out by authorised and qualified personnel!**

**Switch off the pump and disconnect it from the power supply before carrying out maintenance work and repairs!**

**For transport or cleaning, the venting cartridge must be closed.**

#### Caution

**Before start-up, open the venting cartridge (pull cap approx. 5 mm).**

### 11.2 Cleaning and maintenance intervals

**In the event of a diaphragm leakage, the dosing liquid may leak out of the hole in the intermediate flange between the pump and the dosing head.**

**The parts inside the housing are protected from the dosing liquid for a short time (depending on the type of liquid) by the housing sealing. It is necessary to check regularly (daily) if liquid is leaking out of the intermediate flange.**

**For maximum safety, we recommend the pump version with diaphragm leakage detection.**

#### Caution

#### 11.2.1 Changing the gear grease

#### Warning

**The gear grease must only be changed by authorised and qualified personnel.**

**For this purpose, send the pump to Grundfos or an authorised service workshop.**

To ensure trouble-free operation, it is recommended to have the gear grease changed after five years or after 20000 operating hours.

#### 11.2.2 Cleaning the diaphragm and valves

Clean the diaphragm and valves, and replace if necessary (with stainless-steel valves: inner valve parts):

- At least every 12 months or after 4000 operating hours. When operating with a counterpressure of 16 bar, every six months or after 2000 operating hours.
- In the event of a fault.

### 11.3 Cleaning the suction and discharge valves

**Caution** *If possible, rinse the dosing head, e.g. by supplying it with water.*

If the pump loses capacity, clean the suction and discharge valves as follows:

1. Unscrew the valve.
  - DN 20  
Unscrew the screw part resp. valve seat with round pliers.
  - DN 8  
Press out the valve cartridge and remove the valve seat from the ball cage.
2. Clean all parts. Replace faulty parts by new ones.
3. Re-assemble the valve.
4. Replace the O-rings by new ones. Refit the valve. Observe the direction arrow on the valve.

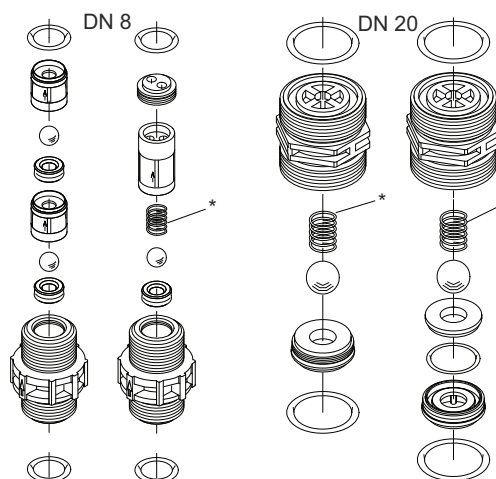

Fig. 26 Stainless-steel or plastic valve DN 8 / DN 20, \* spring-loaded as an option

**The O-rings must be correctly placed in the specified groove.**

#### Caution

**Observe the flow direction (indicated by an arrow on the valve)!**

### 11.4 Maintenance of the relief valve

#### 11.4.1 Cleaning and maintenance intervals

Clean the relief valve, and replace the diaphragm, if necessary.

- At least every 12 months or after 8000 operating hours.
- In the event of a fault.

#### 11.4.2 Replacing the diaphragm of the relief valve

1. Switch off the pump and disconnect it from the power supply.
2. Make it impossible for a return flow or overpressure to occur.
3. Loosen the four screws on the top part of the relief valve.
4. Remove the top part of the relief valve.
5. Remove the diaphragm.
6. Insert a new diaphragm.
7. Refit the top part of the relief valve and cross-tighten the screws.  
Maximum torque: 6 Nm.
8. Start up the dosing system.
9. Tighten the screws on the top part of the relief valve after 48 operating hours.  
Maximum torque: 6 Nm.

## 11.5 Replacing the diaphragm

**Caution** *Adjust the stroke length only while the pump is running!*

**Caution** *For transport or cleaning, the venting cartridge must be closed.*

**Note** *If possible, rinse the dosing head, e.g. by supplying it with water.*

### 11.5.1 Switching off the pump

1. While the pump is running, set the stroke-length adjustment knob to 100 %.
2. Switch off the pump and disconnect it from the power supply.
3. Depressurise the system.
4. Take suitable steps to ensure that the returning dosing medium is safely collected.

### 11.5.2 Replacing the diaphragm

1. Loosen the six dosing head screws.
2. Remove the dosing head.
3. Turn the fan blades until the diaphragm reaches the front dead centre (the diaphragm detaches itself from the diaphragm flange).
4. Unscrew the diaphragm by manually turning it counter-clockwise.
5. Check the parts and replace by new ones, if necessary.
6. Screw in the new diaphragm completely. Then turn it back until the holes in the diaphragm and the flange coincide.
7. Turn the fan blades until the diaphragm reaches the bottom dead centre (the diaphragm is pulled onto the diaphragm flange).
8. Refit the dosing head carefully and cross-tighten the screws. Maximum torque: 6 Nm.
9. Deaerate and start the dosing pump.

**Caution** *Before start-up, open the venting cartridge (pull cap approx. 5 mm).*

*After initial start-up and after each time the diaphragm is changed, tighten the dosing head screws.*

**Caution** *After approximately 6-10 operating hours or two days, cross-tighten the dosing head screws using a torque wrench.*

*Maximum torque: 6 Nm.*

## 12. Fault finding chart

Fault	Cause	Remedy	
1. Dosing pump does not run.	a) Not connected to the power supply.	Connect the power supply cable.	
	b) Incorrect supply voltage.	Replace the dosing pump.	
	c) Electrical failure.	Return the pump for repair.	
	d) The empty indication has responded.	Remove the cause.	
	e) The diaphragm leakage detection has responded.	Replace the diaphragm.	
2. Dosing pump does not suck in.	a) Leaking suction line.	Replace or seal the suction line.	
	b) Cross-section of the suction line too small or suction line too long.	Check with Grundfos specification.	
	c) Clogged suction line.	Rinse or replace the suction line.	
	d) Foot valve covered by sediment.	Suspend the suction line from a higher position.	
	e) Buckled suction line.	Install the suction line correctly. Check for damage.	
	f) Crystalline deposits in the valves.	Clean the valves.	
	g) Diaphragm broken or diaphragm tappet torn out.	Replace the diaphragm.	
	3. Dosing pump does not dose.	a) Air in the suction line and dosing head.	Wait, until the pump has deaerated.
		b) Stroke-length adjustment knob set to zero.	Turn the adjustment knob in the "+" direction.
c) Viscosity or density of medium too high.		Check the installation.	
d) Crystalline deposits in the valves.		Clean the valves.	
e) Valves not correctly assembled.		Assemble the inner valve parts in the right order and check and possibly correct the flow direction.	
f) Injection point blocked.		Check and possibly correct the flow direction (injection unit), or remove the obstruction.	
g) Incorrect installation of lines and peripheral equipment.		Check the lines for free passage and correct installation.	
4. Dosing flow of the pump is inaccurate.		a) Dosing head not fully deaerated.	Repeat the deaeration.
		b) Degassing medium.	Check the installation.
	c) Parts of the valves covered in dirt or incrusted.	Clean the valves.	
	d) Zero point misadjusted.	Adjust the zero point to the actual counterpressure.	
	e) Counterpressure fluctuations.	Install a pressure-loading valve and a pulsation damper.	
	f) Suction height fluctuations.	Keep the suction level constant.	
	g) Siphon effect (inlet pressure higher than counterpressure).	Install a pressure-loading valve.	
	h) Leaking or porous suction line or discharge line.	Replace the suction line or discharge line.	
	i) Parts in contact with the medium are not resistant to it.	Replace with resistant materials.	
	j) Dosing diaphragm worn (incipient tears).	Replace the diaphragm. Also observe the maintenance instructions.	
	k) Supply voltage fluctuations.	Decrease the counterpressure of the pump.	
	l) Variation of the dosing medium (density, viscosity).	Check the concentration. Use an agitator, if necessary.	

**Caution** For further error signals for the control unit, refer to the relevant section.

### 13. Dosing curves

The dosing curves on the following pages are trend curves.

They apply to:

- performance of simple pump (the flow rate is doubled for the double pump)
- water as dosing medium
- suction line with foot valve, 0.5 m flooded suction
- zero point of pump  $Q_0$  for specified pressure, see table below
- standard pump version.

Abbreviation	Description
Q	Dosing flow
$Q_0$	Zero point of the pump The pumps are calibrated so that Q is 0 at 3 bar.
h	Stroke length

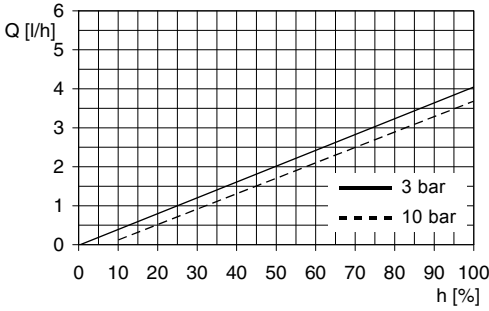

Fig. 27 DMX 4-10 (50 Hz)

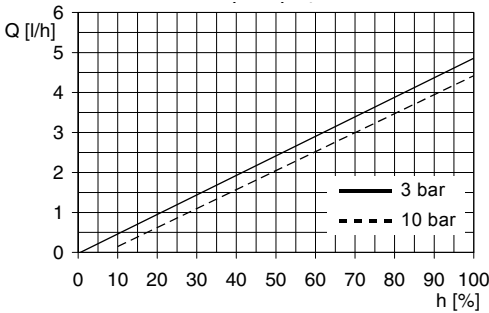

Fig. 28 DMX 4-10 (60 Hz)

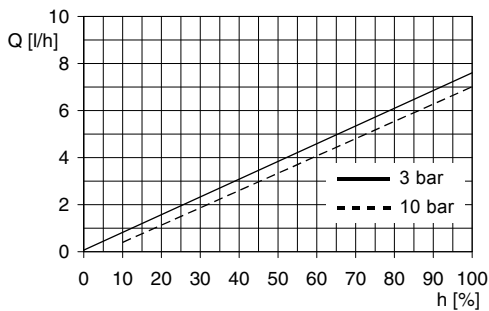

Fig. 29 DMX 7-10 (50 Hz)

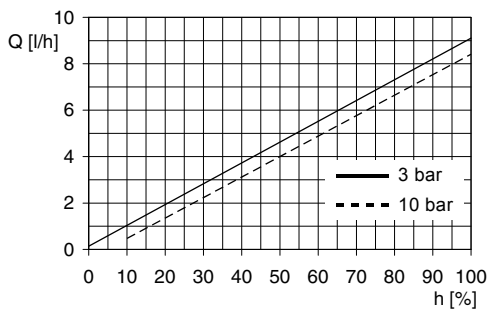

Fig. 30 DMX 7-10 (60 Hz)

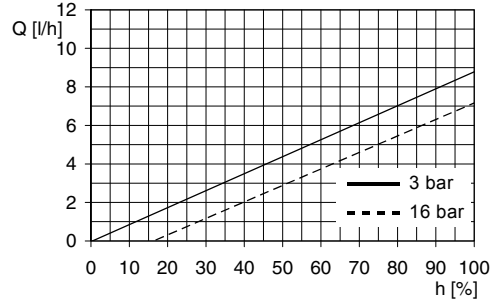

Fig. 31 DMX 7.2-16 (50 Hz)

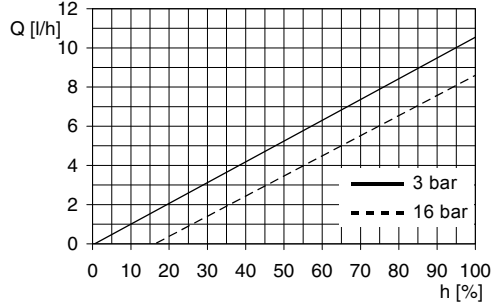

Fig. 32 DMX 7.2-16 (60 Hz)

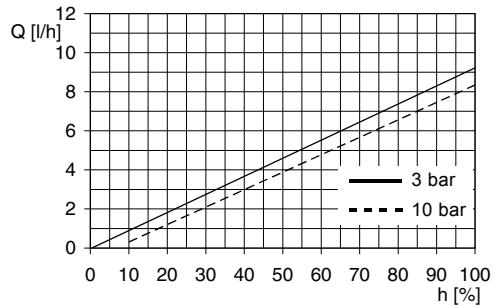

Fig. 33 DMX 9-10 (50 Hz)

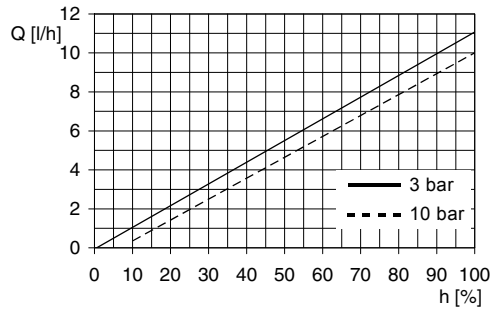

Fig. 34 DMX 9-10 (60 Hz)

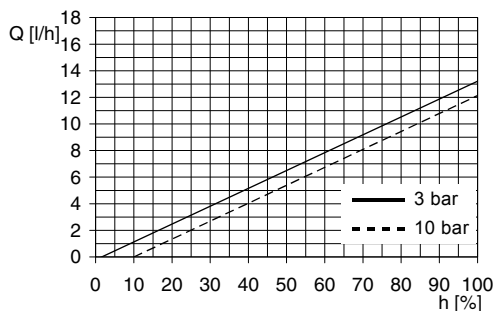

Fig. 35 DMX 12-10 (50 Hz)

TM03 6319 4506

TM03 6320 4506

TM03 6315 4506

TM03 6316 4506

TM03 6317 4506

TM03 6318 4506

TM03 6321 4506

TM03 6322 4506

TM03 6323 4506



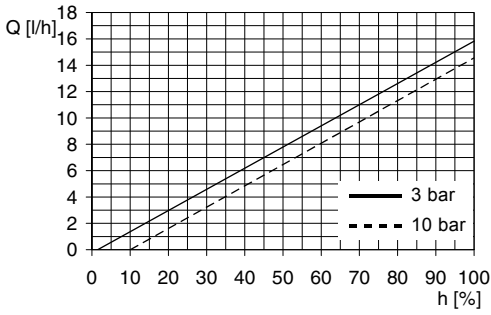

Fig. 36 DMX 12-10 (60 Hz)

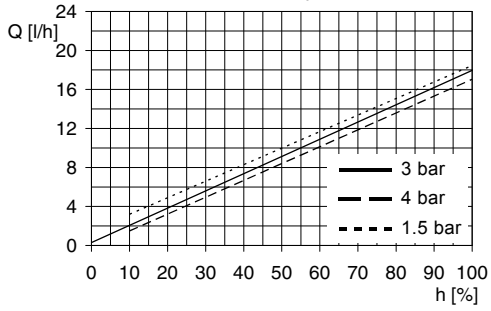

Fig. 37 DMX 17-4 (50 Hz)

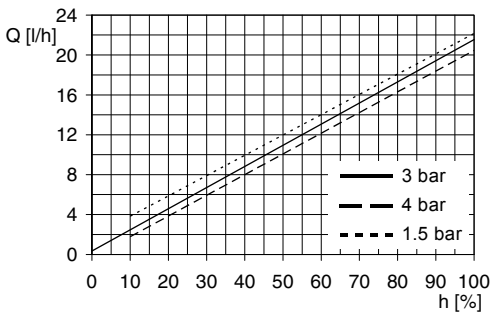

Fig. 38 DMX 17-4 (60 Hz)

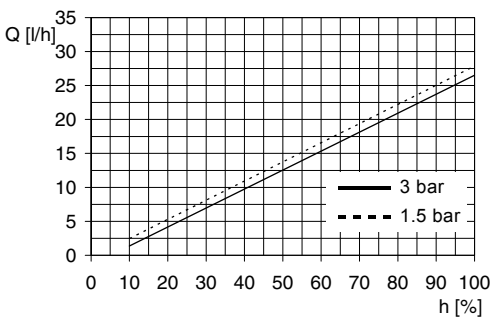

Fig. 39 DMX 25-3 (50 Hz)

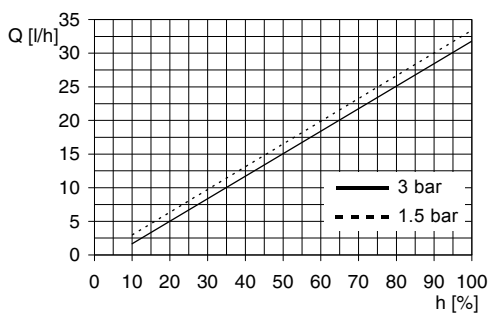

Fig. 40 DMX 25-3 (60 Hz)

TM03 6324 4506

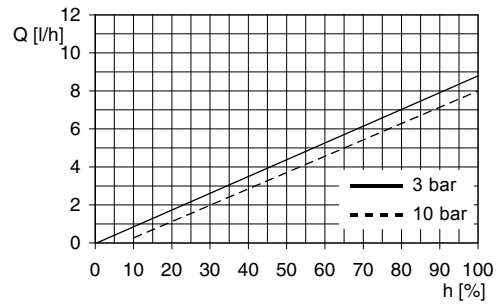

Fig. 41 DMX 8-10 (50 Hz)

TM03 6329 4506

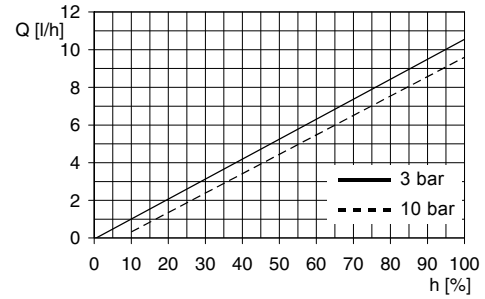

Fig. 42 DMX 8-10 (60 Hz)

TM03 6330 4506

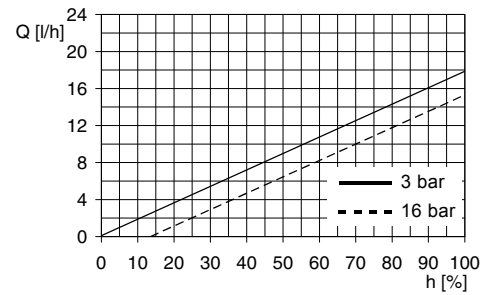

Fig. 43 DMX 13.7-16 (50 Hz)

TM03 6331 4506

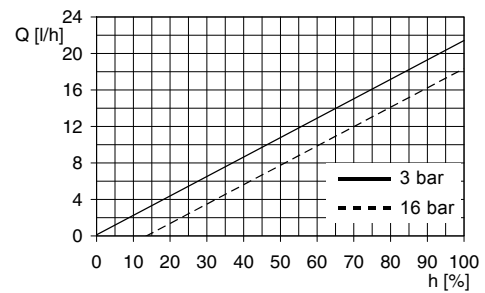

Fig. 44 DMX 13.7-16 (60 Hz)

TM03 6332 4506

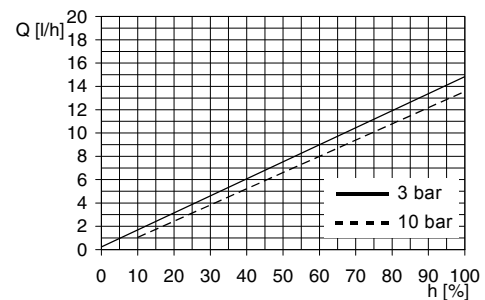

Fig. 45 DMX 14-10 (50 Hz)

TM03 6333 4506

TM03 6327 4506

TM03 6328 4506

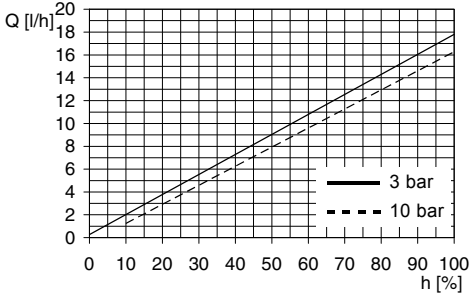

Fig. 46 DMX 14-10 (60 Hz)

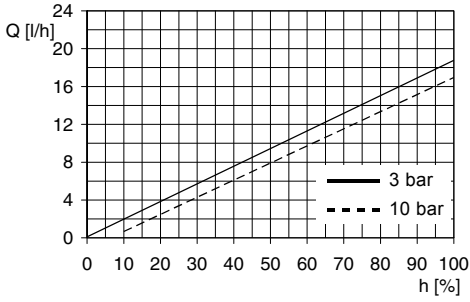

Fig. 47 DMX 18-10 (50 Hz)

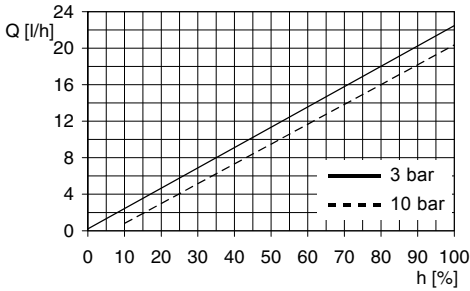

Fig. 48 DMX 18-10 (60 Hz)

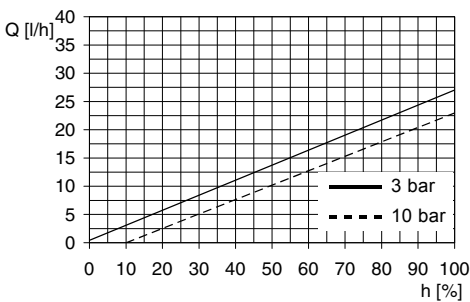

Fig. 49 DMX 26-10 (50 Hz)

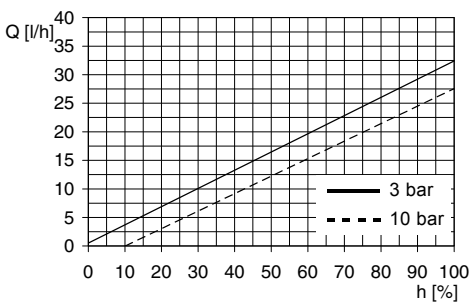

Fig. 50 DMX 26-10 (60 Hz)

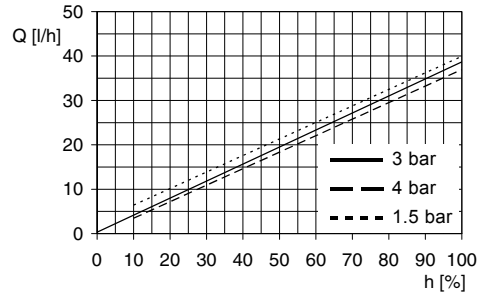

Fig. 51 DMX 39-4 (50 Hz)

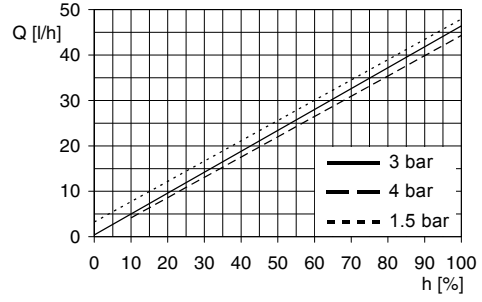

Fig. 52 DMX 39-4 (60 Hz)

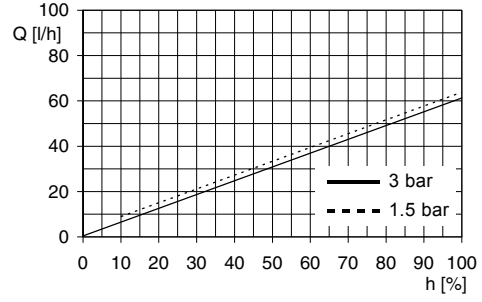

Fig. 53 DMX 60-3 (50 Hz)

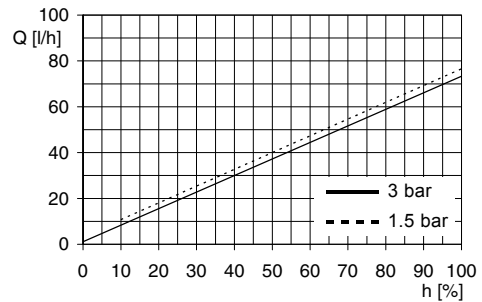

Fig. 54 DMX 60-3 (60 Hz)

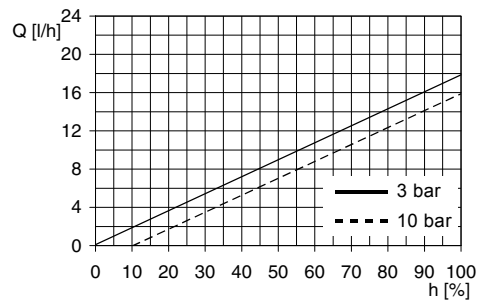

Fig. 55 DMX 16-10 (50 Hz)

TM03 6334 4506

TM03 6335 4506

TM03 6336 4506

TM03 6337 4506

TM03 6338 4506

TM03 6339 4506

TM03 6340 4506

TM03 6341 4506

TM03 6342 4506

TM03 6343 4506

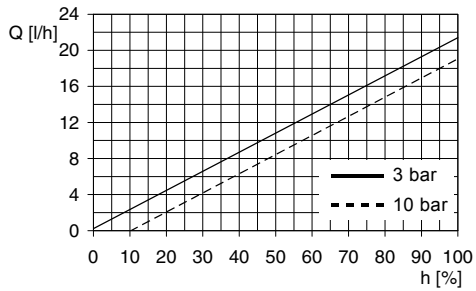

Fig. 56 DMX 16-10 (60 Hz)

TM03 6344 4506

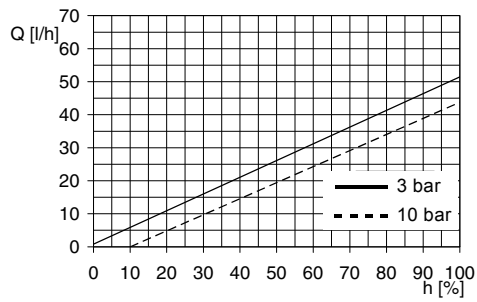

Fig. 61 DMX 50-10 (50 Hz)

TM03 6349 4506

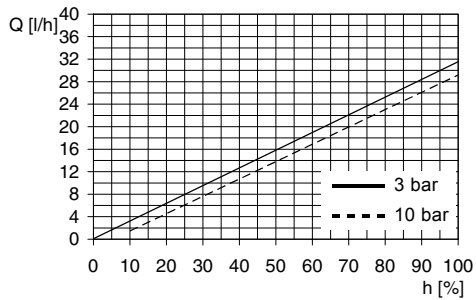

Fig. 57 DMX 27-10 (50 Hz)

TM03 6345 4506

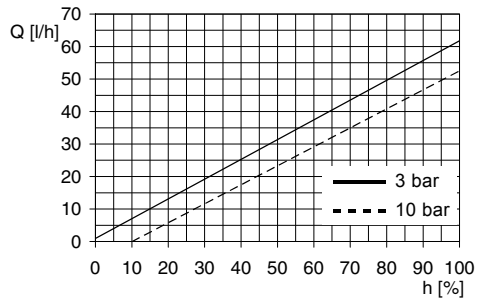

Fig. 62 DMX 50-10 (60 Hz)

TM03 6350 4506

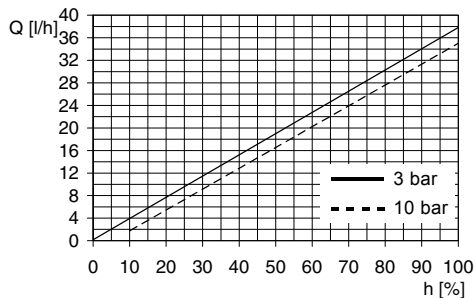

Fig. 58 DMX 27-10 (60 Hz)

TM03 6346 4506

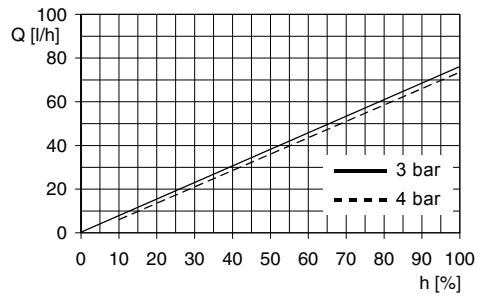

Fig. 63 DMX 75-4 (50 Hz)

TM03 6351 4506

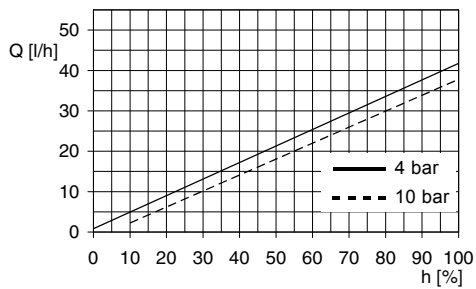

Fig. 59 DMX 35-10 (50 Hz)

TM03 6347 4506

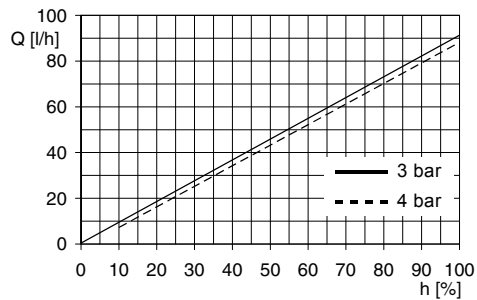

Fig. 64 DMX 75-4 (60 Hz)

TM03 6352 4506

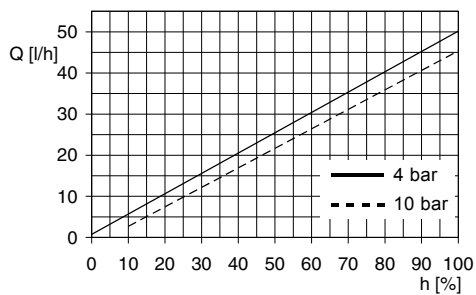

Fig. 60 DMX 35-10 (60 Hz)

TM03 6348 4506

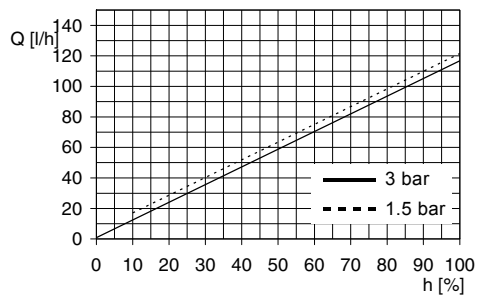

Fig. 65 DMX 115-3 (50 Hz)

TM03 6353 4506

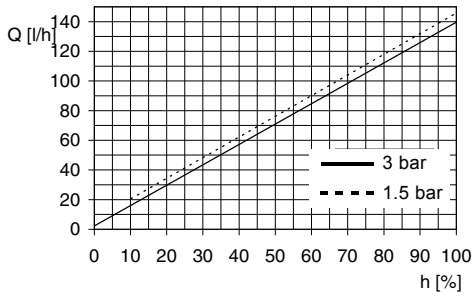

Fig. 66 DMX 115-3 (60 Hz)

TM03 6354 4506

## 14. Disposal

This product or parts of it must be disposed of in an environmentally sound way. Use appropriate waste collection services. If this is not possible, contact the nearest Grundfos company or service workshop.

---

Subject to alterations.

# Safety declaration

Please copy, fill in and sign this sheet and attach it to the pump returned for service.

**Note** Fill in this document using English or German language.

We hereby declare that this product is free from hazardous chemicals,  
biological and radioactive substances:

Product type: \_\_\_\_\_

Model number: \_\_\_\_\_

No media or water: \_\_\_\_\_

A chemical solution, name: \_\_\_\_\_

(see pump nameplate)

## Fault description

Please make a circle around the damaged part.  
In the case of an electrical or functional fault, please mark the cabinet.



Please give a short description of the fault:

\_\_\_\_\_  
Date and signature

\_\_\_\_\_  
Company stamp





<b>91834765</b> 1213
ECM: 1125369