

T Series Pump Guide

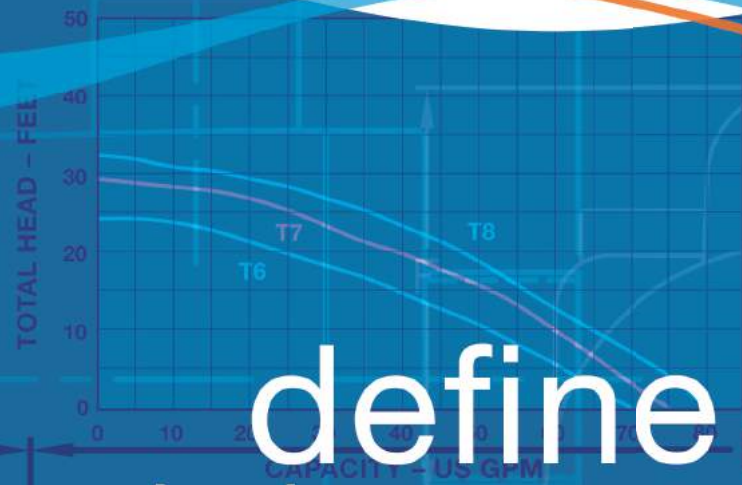

define
design
deliver

T Series Vertical Seal-less Immersible Pump

1/3, 1/2, 3/4, 1, 1-1/2 HP



The new T Series Webster by Hayward thermoplastic pump features a single, non-coupled motor/impeller shaft with a proprietary patent-pending shaft seal. Compared to a pump with a coupled shaft and o-ring seal, the T Series design combines the multiple components into one thereby reducing the possibility of failure by components.

The new shaft seal is made from PTFE allowing greater chemical compatibility and less wear due to degradation over time that would reduce pump performance.

The shaft sleeve has also been extended to move the seal point up and away from the weep hole protecting the metal shaft as well as centralizing the sleeve.

The new T Series is offered in CPVC as standard for the pump head assembly, with GFPP and PVDF as optional materials.

KEY FEATURES

- Single, Non-Coupled Motor Shaft 303 SS
- Proprietary, Patent-Pending PTFE Shaft Seal
- Extended Shaft Sleeve

BENEFITS

- Solid, Stable One-Piece Shaft
- Seal Point Away from Weep Hole
- Less Vibration
- Runs True

TYPICAL APPLICATIONS

- Chemical Processing and Transfer
- Metal Plating
- Waste and Water Treatment
- Mining
- Aquatic and Animal Life Support Systems
- Electronics

OPTIONS

- Optional Inlet Screen
- In-Tank Filtration
- Impeller Trim Variations
- Explosion-Proof Motors
- Wash-Down Motors
- 575V Motors

MATERIALS

- CPVC Cell Class 23447 per ASTM D1784
- GFPP Cell Class 85580 per ASTM D4101
- PVDF per ASTM D3222, II



EXPLODED VIEW

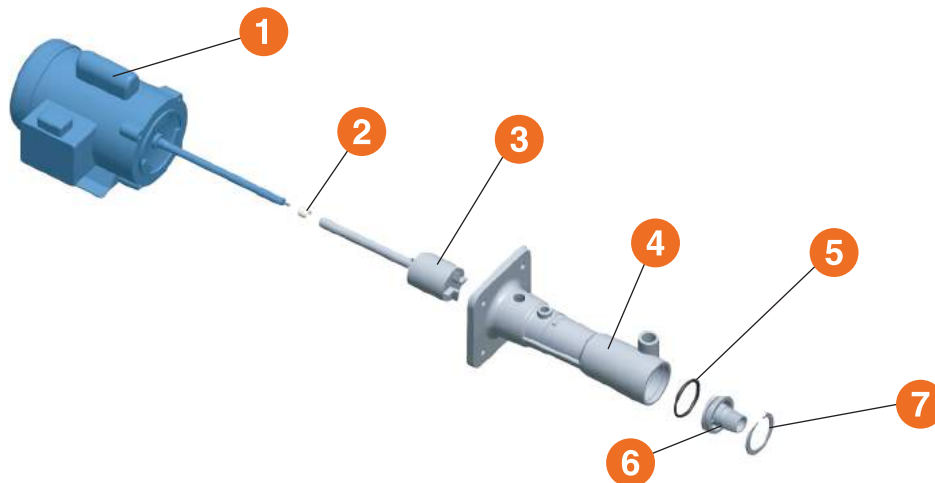

PARTS LIST

1. Motor and Shaft
2. Impeller Seal (PTFE)
3. Impeller
4. Body
5. End Cap O-Ring
6. End Cap
7. Retainer Clip

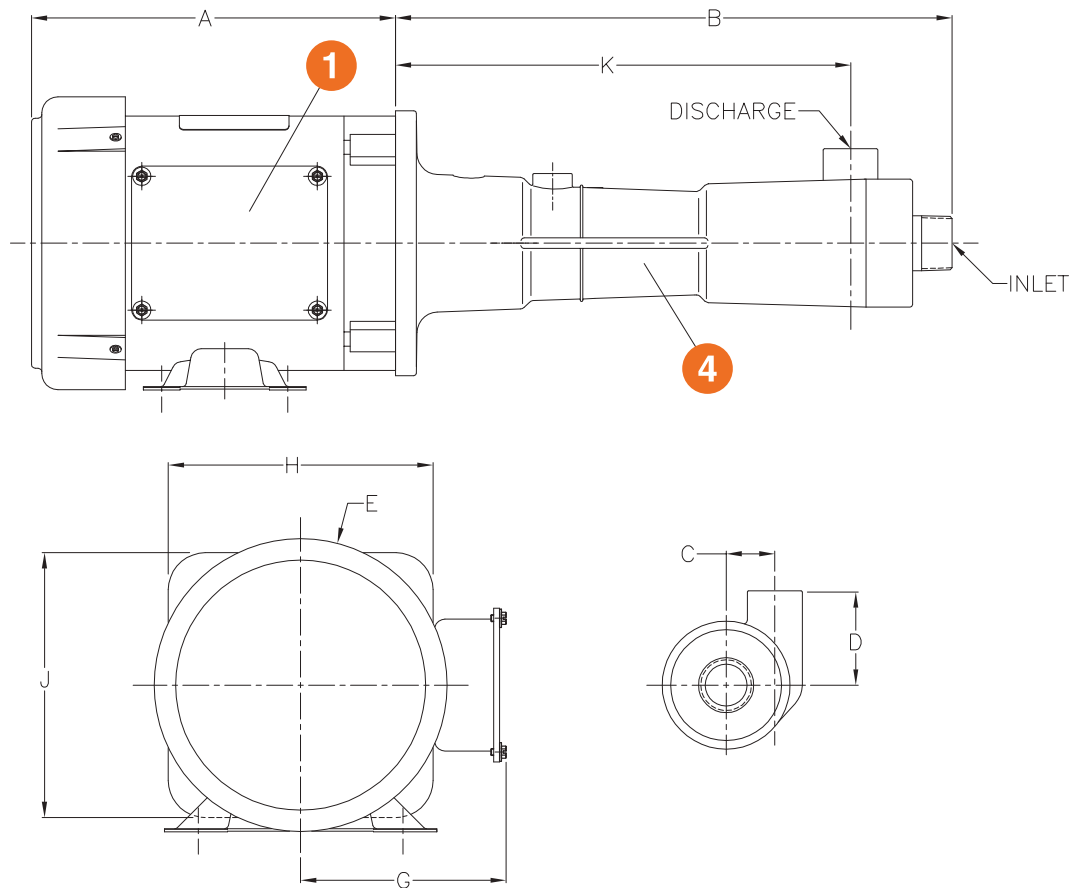

T SERIES DIMENSIONS – INCHES / MILLIMETERS

	A in / mm	B in / mm	C in / mm	D in / mm	E in / mm	G in / mm	H in / mm	J in / mm	K in / mm	INLET	DISCHARGE	HP
T2	8.68 / 220	13.28 / 337	1.16 / 29	2.25 / 57	6.98 / 177	4.90 / 124	6.32 / 161	6.32 / 161	10.86 / 276	1" MNPT	1/2" FNPT	1/3
T4	9.19 / 233	12.90 / 328	1.38 / 35	2.88 / 70	6.98 / 177	4.90 / 124	6.32 / 161	6.32 / 161	9.77 / 248	1-1/4" MNPT	1" FNPT	1/2
T5	9.69 / 246	12.90 / 328	1.38 / 35	2.88 / 73	6.98 / 177	4.90 / 124	6.32 / 161	6.32 / 161	9.77 / 248	1-1/4" MNPT	1" FNPT	3/4
T6	9.69 / 246	11.40 / 290	1.69 / 43	3.21 / 82	6.98 / 177	4.90 / 124	6.32 / 161	6.32 / 161	7.97 / 202	1-1/2" MNPT	1-1/4" FNPT	1
T7	9.94 / 252	11.40 / 290	1.69 / 43	3.21 / 82	6.98 / 177	4.90 / 124	6.32 / 161	6.32 / 161	7.97 / 202	1-1/2" MNPT	1-1/4" FNPT	1
T8	10.44 / 265	11.40 / 290	1.69 / 43	3.21 / 82	6.98 / 177	4.90 / 124	6.32 / 161	6.32 / 161	7.97 / 202	1-1/2" MNPT	1-1/4" FNPT	1-1/2

Dimensions are subject to change without notice – consult factory for installation information.

SPECIFICATIONS

PUMP HEAD: CPVC, GFPP and PVDF

CONNECTIONS:..... Threaded NPT

MOTOR SHAFT: 303 SS

SHAFT SEAL: Patent-pending shaft seal

PERFORMANCE:..... Models for flow rates from 5 to 80 GPM with TDHs of up to 45 feet. T Series motors and pumps are matched for non-overloading, continuous duty performance throughout the entire pump performance range

MOTORS:..... Single or three-phase motors are available with 1/3 - 1-1/2 Horsepower Ratings, and are heavy-duty TEFC, epoxy painted and rated for continuous service. Also available with Wash Down or Explosion-Proof motors

HP RATINGS:..... T2=1/3 HP, T4=1/2 HP, T5=3/4 HP, T6 and T7=1 HP, T8=1-1/2 HP

TECHNICAL SPECS AND PERFORMANCE DATA

MODEL	HP	VOLTAGE	MAX LOAD amps	APPROXIMATE WEIGHT lbs / kg
T2	1/3	115/230	4.6 / 2.3	22 / 10
		208-230/460	1.2 / 0.6	
T4	1/2	115/230	6.0 / 3.0	24 / 11
		208-230/460	2.4 / 1.2	
T5	3/4	115/230	8.6 / 4.3	26 / 12
		208-230/460	3.5 / 1.6	
T6	1	115/230	8.6 / 4.3	28 / 13
		208-230/460	2.4 / 1.2	
T7	1	115/230	10.8 / 5.4	30 / 13.5
		208-230/460	3.5 / 1.6	
T8	1-1/2	115/230	14.8 / 7.4	32 / 14.5
		208-230/460	4.4 / 2.2	

PUMP PERFORMANCE CURVES – 50 HZ

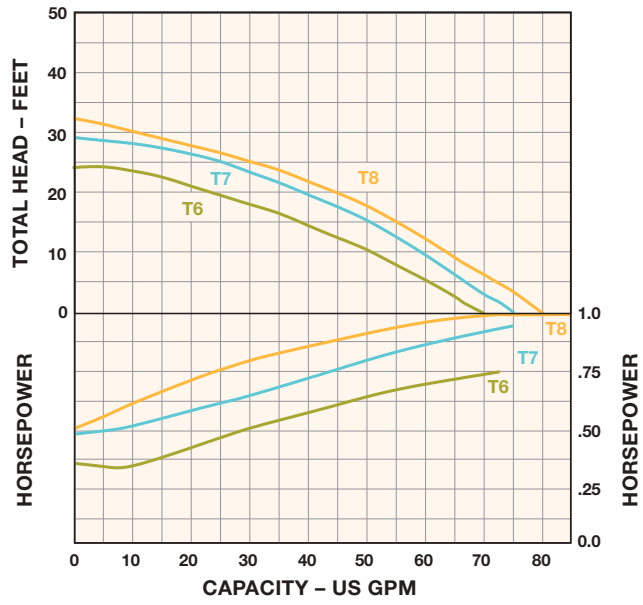
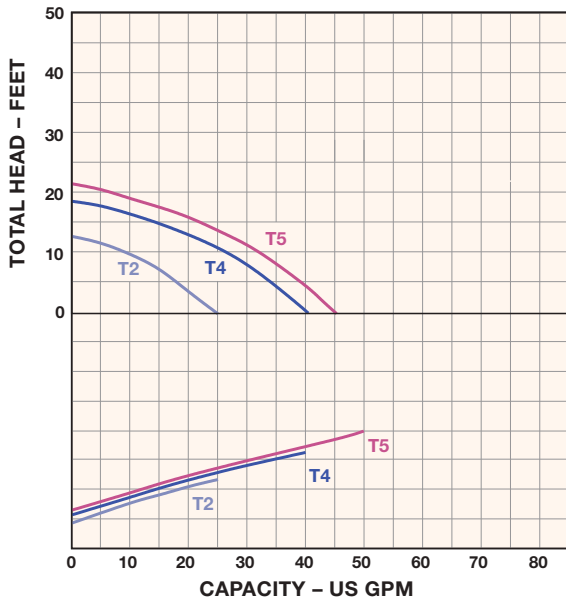

PUMP PERFORMANCE CURVES – 60 HZ

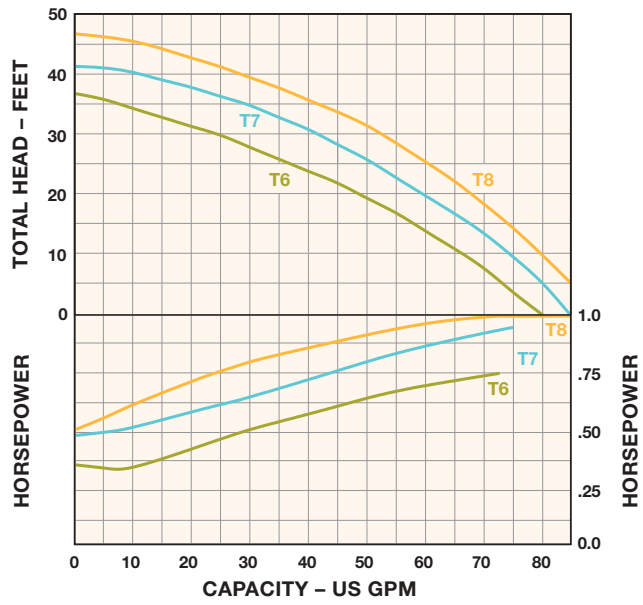
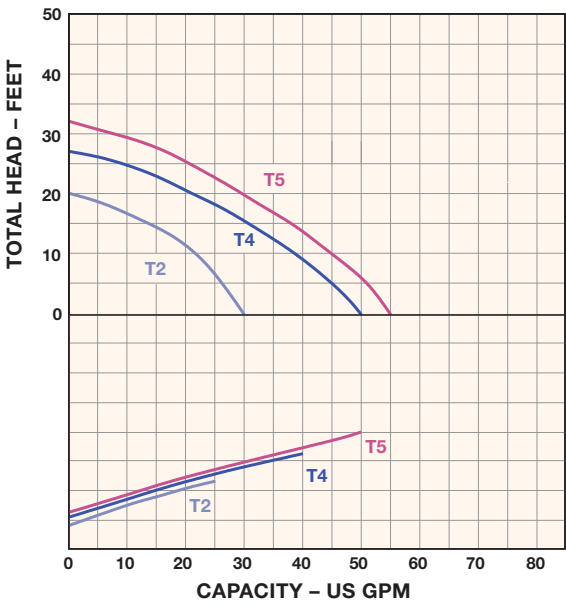

Additional Hayward Thermoplastic Pumps and Related Products

C SERIES CENTRIFUGAL PUMPS

KEY FEATURES

- CPVC, GFPP or PVDF
- John Crane Type 21 Seal
- Single or 3-Phase Motors
- 1/3 – 1-1/2 HP Ratings
- Flow Rates From 5 to 130 GPM; TDH up to 150 feet



D SERIES VERTICAL SEAL-LESS PUMP

KEY FEATURES

- CPVC, PP or PVDF Construction
- Single Phase Motors
- 1/8 HP; 115/230 VAC
- Flow Rates From 2 to 17 GPM; TDH up to 18'
- PTFE Fume Barrier



R SERIES MAGNETIC DRIVE PUMPS

KEY FEATURES

- GFPP or ETFE
- Single or 3-Phase Motors
- 1/3 – 5 HP Ratings
- Flow Rates From 5 to 140 GPM



S SERIES VERTICAL SEAL-LESS PUMPS

KEY FEATURES

- CPVC, PP, GFPP or PVDF
- Single or 3-Phase Motors
- 1/15 – 5 HP Ratings
- Flow Rates From 5 to 130 GPM; TDH up to 115'



TC SERIES BALL CHECK VALVES

KEY FEATURES

- Prevent Loss of Prime and/or Draining of the System
- Foot Valves Option
- Spring-Loaded Y-Checks Available
- All Thermoplastic – No Corrosion or Sticking



SB SERIES BASKET STRAINERS

KEY FEATURES

- Protect Your Investment
- Remove Damage Causing Particulate Matter From Process Media Before it Reaches Your Pump
- Simplex and Duplex Configurations
- Baskets available in PVC, CPVC, PP, SSTL, Hastelloy® and Monel®



Hayward is a registered trademark of Hayward Industries, Inc. © 2012 Hayward Industries, Inc.

– Hastelloy is a registered trademark of Haynes International, Inc.
– Monel is a registered trademark of Advanced Elastomer Systems.

TSP0412

21674SA041612KV