



**47109491**  
Edition 2  
October 2013

## **Air Impulse Wrench (Twin Blade)**

**Model 380SQ1 and 380SQ1-EU**

---

# **Maintenance Information**



**Save These Instructions**

**IR** *Ingersoll Rand*

## Product Safety Information

### WARNING

- Failure to observe the following warnings, and to avoid these potentially hazardous situations, could result in death or serious injury.
- Read and understand this and all other supplied manuals before installing, operating, repairing, maintaining, changing accessories on, or working near this product.
- Always wear eye protection when operating or performing maintenance on this tool. The grade of protection required should be assessed for each use and may include impact-resistant glasses with side shields, goggles, or a full face shield over those glasses.
- Always turn off the air supply, bleed the air pressure and disconnect the air supply hose when not in use, before installing, removing or adjusting any accessory on this tool, or before performing any maintenance on this tool or any accessory.

**Note:** When reading the instructions, refer to exploded diagrams in parts Information Manuals when applicable (see under Related Documentation for form numbers).

## Changing The Mechanism Fluid

To change the Mechanism Fluid in the Impulse Mechanism, proceed as follows:

1. Use a pointed probe to push the Spring Seat (66) against the Retaining Sleeve Spring (65). While the Spring is compressed, use another pointed probe or thin blade screwdriver to remove the Retaining Ring (67). Lift the Spring Seat, Spring and Bit Retaining Sleeve (64) off the Drive Shaft (43) and remove the Bit Retaining Ball (63).
2. Remove the Rubber Housing Boot (68).
3. Using copper-covered vise jaws, carefully grasp the flats of the Mechanism Cover (58) with the output end of the Drive Shaft downward.
4. Using an adjustable wrench, unscrew the Motor Housing Assembly (1) from the Mechanism Cover. This is a left-hand thread, rotate the Motor Housing clockwise to remove it. Refer to Dwg. TPD1292.

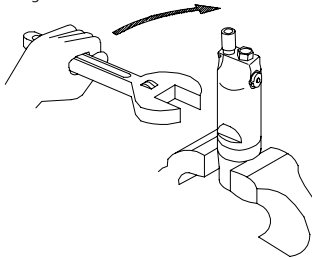

(Dwg. TPD1292)

5. Lift the assembled motor off the Mechanism Cover and pull the mechanism assembly out of the Cover.
6. Using a 1.5 mm hex (30) clockwise until the Screw stops. Rotate the Screw counterclockwise until it stops or makes six complete revolutions.
7. Using the special Tee Wrench furnished in the Tool Kit (Part No. 180PQ-99), remove the Oil Plug (49) and Oil Plug Seal (50).
8. With the oil plug opening downward over a container, rotate the Drive Shaft to purge the fluid from the mechanism.
9. Using the syringe and fluid from the Fluid Replacement Kit (Part No. EQ106S-K400), fill the mechanism with the fluid furnished in the Kit. Refer to Dwg. TPD1293.

### NOTICE

**Do Not Substitute Any Other Fluid. Failure to use the impulse mechanism fluid provided could damage the tool, increase maintenance and decrease performance. Use only clean fluid in these tools.**

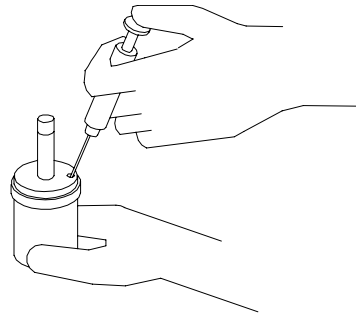

(Dwg. TPD1293)

10. Submerge the fill opening in the remainder of the fluid, and using a wrench, rotate the Drive Shaft to purge any remaining air from the system.
11. Thread the Oil Plug with the Oil Plug Seal into the mechanism until it is snug.
12. Using a 1.5 mm hex wrench, turn the Torque Adjustment Screw clockwise until it stops. This is the maximum torque position. Back the Screw off between 3/4 and 1-1/4 turns to avoid erratic readings.
13. Wipe the outside of the mechanism dry and clean and remove the Oil Chamber Plug. Using the syringe, withdraw .25 cc of fluid from 180SQ1 models and .3 cc of fluid from 280SQ1 models.
14. Install the Oil Chamber Plug and tighten it between 20 and 25 in-lb (2.3 and 2.8 Nm) torque.
15. Insert the mechanism assembly, output end leading, into the Mechanism Cover clamped in the vise jaws.
16. Insert the hex end of the rotor shaft into the hex recess at the rear of the Drive Shaft and thread the assembled Motor Housing onto the Mechanism Cover. This is a left-hand thread. Rotate the Housing counterclockwise to tighten it. Refer to Dwg. TPD1294.

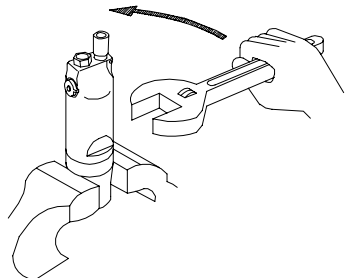

(Dwg. TPD1294)

## Disassembly

### General Instructions

1. Do not disassemble the tool any further than necessary to replace or repair damaged parts.
2. When grasping a tool or part in a vise, always use leather-covered or copper-covered vise jaws to protect the surface of the part and help prevent distortion. This is particularly true of threaded members and housings.
3. Do not remove any part which is a press fit in or on an assembly unless the removal of that part is necessary for repairs or replacement.

### Disassembly of the Impulse Mechanism

1. Use a pointed probe to push the Spring Seat (66) against the Retaining Sleeve Spring (65). While the Spring is compressed, use another pointed probe or thin blade screwdriver to remove the Retaining Ring (67). Lift the Spring Seat, Spring and Bit Retaining Sleeve (64) off the Drive Shaft (43) and remove the Bit Retaining Ball (63).
2. Remove the Rubber Housing Boot (68).
3. Using copper-covered vise jaws, carefully grasp the flats of the Mechanism Cover (58) with the output end of the Drive Shaft downward.
4. Using an adjustable wrench, unscrew the Motor Housing Assembly (1) from the Mechanism Cover.

#### NOTICE

This is a left-hand thread, rotate the Motor Housing clockwise to remove it.

Refer to Dwg. TDP1292.

5. Lift the assembled motor off the Mechanism Cover and pull the mechanism assembly out of the Cover. Remove the Bushing Spacer (61).
6. Using a 1.5 mm hex wrench, rotate the Torque Adjustment Screw (30) clockwise until the Screw stops. Rotate the Screw counterclockwise until it stops or makes six complete revolutions.
7. Using the special Tee Wrench furnished in the Tool Kit (Part No. 180PQ-99), remove the Oil Plug (49) and Oil Plug Seal (50).
8. With the oil plug opening downward over a container, rotate the Drive Shaft to purge the fluid from the mechanism.
9. Grasp the flats of the Housing Assembly (29) in vise jaws with the output end of the Drive Shaft downward.
10. Insert the pins of the spanner plug from the No. 180PQ-99 Tool Kit into the two holes in the Housing Cap (35). Using a wrench on the plug, unscrew and remove the Housing Cap from the Housing Assembly.

Refer to Dwg. TPD1295.

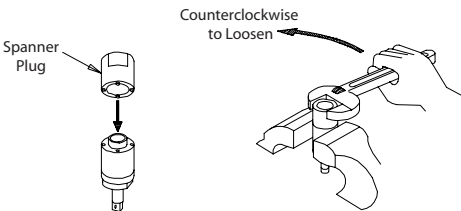

(Dwg. TPD1295)

11. Stand the disassembly arbor from the Tool Kit, large end downward, on a workbench or the table of an arbor press. Insert the output end of the Drive Shaft into the central opening and either tap the Housing downward off the components or use the pressing sleeve in the Kit to press the Housing downward off the components.

Refer to Dwg. TPD1296.

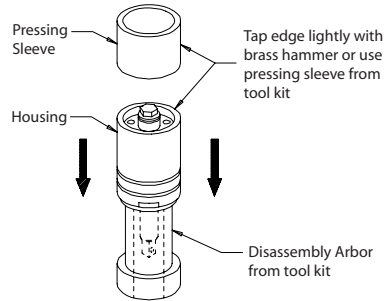

(Dwg. TPD1296)

12. Disassemble the components of the mechanism in the sequence shown in Drawing TPA1341 on Page 17.

### Disassembly of the Motor

1. Grasp the Motor Housing (1) in vise jaws with the shaft of the Rotor (23) upward.
2. Insert the pins of the end plate spacer spanner into the holes in the Front End Plate Spacer (28). Using a wrench, unscrew and remove the Spacer. This is a left-hand thread; rotate the wrench clockwise to remove the Spacer.

End Plate Spacer Spanner

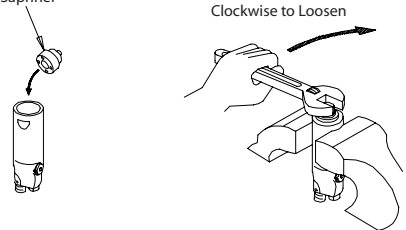

(Dwg. TPD1297)

3. Reposition the Motor Housing in the vise jaws so that the vise jaws grip the end of the rotor shaft and the Housing is horizontal. Tap the edges of the Housing surrounding the motor bore with a plastic hammer to separate the Housing from the motor.

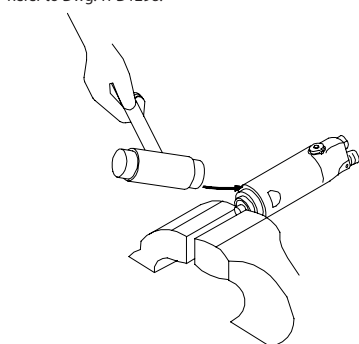

- Remove the motor from the vise jaws and remove the Front End Plate (25), Front End Plate Bearing (27), Cylinder Assembly (20) and Vanes (24) from the Rotor.
- On the table of an arbor press, support the Rear End Plate (18) with blocks as close to the Rotor as possible and press the Rotor out of the Rear End Plate and Rear Rotor Bearing (19).
- To remove the Rear Rotor Bearing from the Rear End Plate, use a small drift or pin punch through the central opening of the Rear End Plate to tap the Bearing out of the End Plate. Refer to Dwg. TPD1299.

**NOTICE**

**Do not enlarge or damage the shaft hole in the End Plate.**

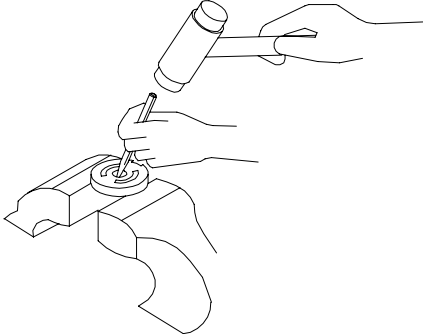

(Dwg. TPD1299)

**Assembly**

**General Instructions**

- When grasping a tool or part in a vise, always use leather-covered or copper-covered vise jaws to protect the surface of the part and help prevent distortion. This is particularly true of threaded members and housings.
- Always press on the inner ring of a ball-type bearing when installing the bearing on a shaft.
- Always press on the outer ring of a ball-type bearing when pressing the bearing into a bearing recess.
- Except for bearings and mechanism parts, always clean every part and wipe every part with a thin film of oil before installation.
- Wipe a thin film of mechanism fluid on all internal mechanism components before installing them in the mechanism.
- Apply a film of O-ring lubricant to every O-ring before installation.

**Assembly of the Motor**

- Thread the Inlet Bushing (13) into the threaded hole at the rear of the handle of the Motor Housing (1) and tighten it between 30 and 35 ft-lb (40 and 47 Nm) torque.
- Position the Exhaust Deflector Assembly (15) in the hole at the rear of the motor housing handle and install the Deflector Retaining Pin (16) to secure it in position.

**NOTICE**

**It may be necessary to slide the Assembly in or out in order to align the groove in the Assembly with the pin hole.**

- Install two new Reverse Valve Bushing Seals (14) in the grooves inside the reverse valve bushing, if they were removed.
- Install the Reverse Valve Seal (6) in the groove next to the large hub of the Reverse Valve (5).

- Press the Reverse Lever Pin (4) out of the Reverse Lever (2) and remove the Reverse Lever, Reverse Lever Seal (3), Throttle Valve Spring (9) and the Throttle Ball (10).
- Spread the end of the Suspension Bail (17), where the ends enter the Motor Housing, and remove the Bail.
- Using a pin punch, tap the Throttle Lever Pin (8) and the Deflector Retaining Pin (16) out of the Handle. Remove the Throttle Lever (7), Throttle Plunger (11) and the Exhaust Deflector Assembly (15).
- Push the Reverse Valve Assembly (5) out the throttle lever end of the Housing and Remove the two Reverse Valve Bushing Seals (14) if they need to be replaced.
- Unscrew and remove the Inlet Bushing (13).

- Install the Reverse Valve Assembly, seal end trailing, into the lever side of the Motor Housing. Make certain the square depression on the sft of the Valve faces forward toward the output end of the tool.
- Install the Reverse Lever Seal (3) in the groove on the small hub of the Reverse Lever (2).
- Insert the Throttle Ball (10) followed by the Throttle Valve Spring (9) into the Reverse Valve Assembly.
- Position the Reverse Lever Assembly on the Reverse Valve Assembly with the indicator lever rearward. Make certain the crossholes in the Lever align with the pin holes in the Valve. Press the Reverse Lever Pin (4) into the Lever and Valve.
- Insert the Throttle Plunger (11) into the Reverse Valve Assembly.
- Position the Throttle Lever (7) on the Motor Housing and secure it by pressing the Throttle Lever Pin (8) into the Housing and Lever.
- Using an arbor press and a piece of tubing that contacts the outer ring of the bearings, press the Front End Plate Bearing (27) into the Front End Plate (25) and the Rear End Plate Bearing (19) into the Rear End Plate (18). Refer to Dwg. TPD1300.

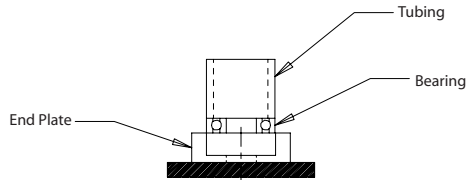

(Dwg. TPD1300)

- Stand the Rotor (23) on the table of an arbor press. It should be upright on a flat metal plate having a clearance hole for the shaft. The shaft with the hex must be upward.

13. Place a 0.001" (0.025 mm) shim on the upward surface of the large portion of the rotor body. Using a piece of tubing that contacts the inner ring of the bearing, press the Front Rotor Bearing and Front End Plate, End Plate leading, onto the shaft of the Rotor until the End Plate contacts the shim. Remove the shim. Refer to Dwg. TPD1301.

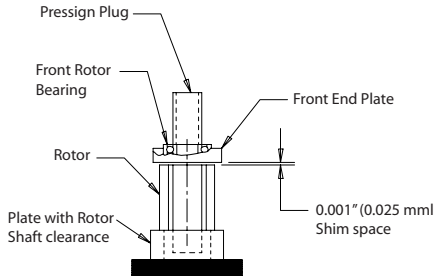

(Dwg. TPD1301)

14. Coat each Vane (24) with a thin film of oil and insert a Vane into each of the rotor vane slots with the straight edge of the Vane outward.
15. Install the Cylinder (20) over the Vanes and Rotor with the end of the Cylinder having the Alignment Pin (22) in the middle of the four holes positioned toward the Front End Plate. Refer to Dwg. TPD1302.

Make certain the Pin enters the hole in the face of the Front End Plate.

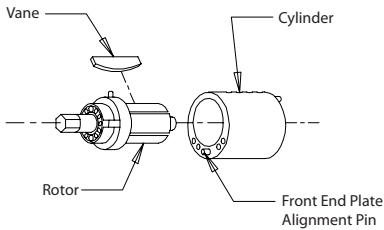

(Dwg. TPD1302)

16. Place the Rear End Plate and Bearing against the face of the Cylinder, Bearing end trailing. Make certain the Rear End Plate Alignment Pin (21) protrudes through the hole in the End Plate.
17. Insert the assembly, Rear End Plate leading, into the Motor Housing making sure the Alignment Pin protruding through the End Plate enters the proper hole in the Housing. It may be necessary to tap the assembly into position with a brass or plastic hammer. Refer to Dwg. TPD1303.

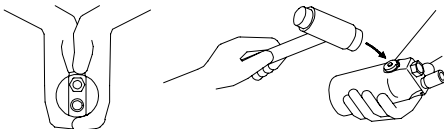

(Dwg. TPD1303)

18. Grasp the Motor Housing in vise jaws with the rotor shaft upward. Thread the Front End Plate Spacer (28) into the Housing and using the end plate spacer spanner, tighten the Spacer to 12 ft.-lb. (16 Nm) torque.

## NOTICE

This is a left-hand thread; rotate the wrench counterclockwise to tighten.

Refer to Dwg. TPD1304.

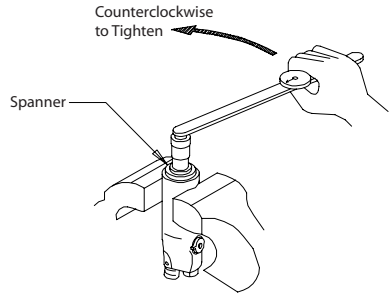

(Dwg. TPD1304)

19. After installing the Front End Plate Spacer, grasp the shaft of the Rotor and rotate it by hand. If the Rotor does not turn easily, disassemble the motor unit and determine where the assembly is binding. The motor must rotate freely before proceeding further with the assembly.

## Assembly of the Impulse Mechanism

1. Insert the long shaft with the annular groove of the Spring Guide (41) into the central opening of the O-ring Installer furnished with the Tool Kit (Part No. 180PQ-99). Place the Spring Guide Seal (42) on the tapered end of the installer and roll the Seal up the taper and into the groove on the large body of the Spring Guide. Refer to Dwg. TPD1305.

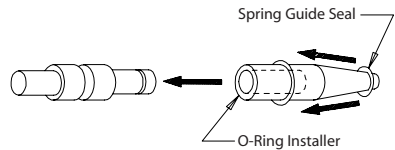

(Dwg. TPD1305)

2. Insert the Relief Valve (40), large end trailing, into the Liner (38). Insert the assembled Spring Guide, long hub with annular groove leading, into the Liner against the Relief Valve. Refer to Dwg. TPD1306.

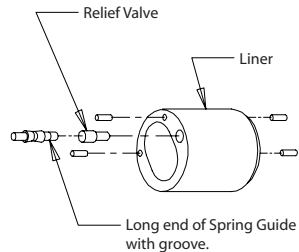

(Dwg. TPD1306)

3. Place a Blade (44) into one of the slots of the Drive Shaft (42) with the Blade Assembly Pins (45) inward.
4. From the opposite side of the Shaft, encircle each Pin with a Blade Spring (46).

5. Install the Assembly Pins of the remaining Blade in the open ends of the Springs.  
Refer to Dwg. TPD1307.

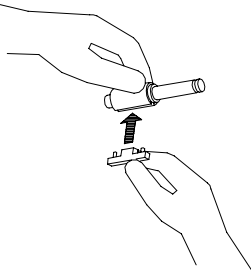

(Dwg. TPD1307)

6. Compress the Springs with the Blades until both Blades are flush with the Drive Shaft and install the assembly in the Liner with the output end of the Drive Shaft protruding out the end of the Liner containing the Spring Guide.  
Refer to Dwg. TPD1308. Make certain the ends of the Blades are flush with the ends of the Liner.

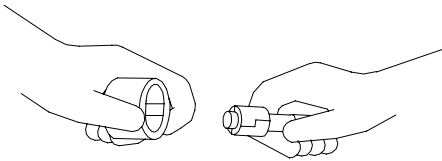

(Dwg. TPD1308)

7. Install the Drive Shaft Seal (56) followed by the Seal Back-up Ring (57) on the Drive Shaft against the hub.  
Refer to Dwg. TPD1309.

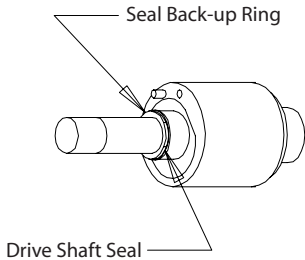

(Dwg. TPD1309)

8. The Torque Adjustment Screw (30) can only be installed from the liner end of the Impulse Housing (29). If the Torque Adjustment Screw was removed, proceed as follows:
  - a. Insert a 1.5 mm hex wrench into the threaded hole for the Torque Adjustment Screw from the oil plug end of the Housing.
  - b. From the opposite end of the Housing, install the hex of the Torque Adjustment Screw onto the hex wrench.
  - c. Push the Screw and wrench toward the threaded hole until it contacts the face of the Housing.
  - d. While applying finger pressure to the rivet end of the Screw, rotate the wrench counterclockwise to thread the Screw into the Housing. Continue rotating the Screw until the rivet end stops against the face of the Housing.

- e. Insert the two Adjustment Screw Plug Locks (31) and the Plug Lock Spring (32) into the crosshole leading to the Adjustment Screw. Thread the Plug Lock Screw (33) into the same hole to capture the components.  
Refer to Dwg. TPD1310.

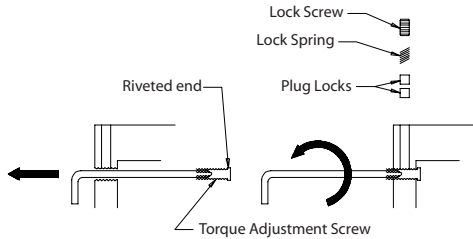

(Dwg. TPD1310)

9. If the Oil Stop Cap Assembly (51) was removed from the Front Liner Cover (47), install the Stop Cap O-ring (52) and Back-up Ring (53) in the groove of the Cap and insert the assembly into the Cover.  
Refer to Dwg. TPD1311.

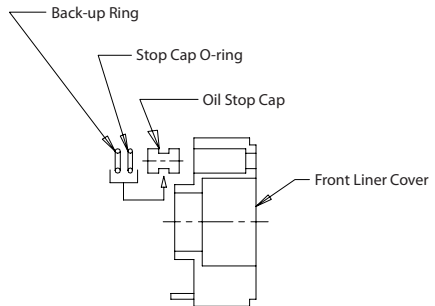

(Dwg. TPD1311)

10. Install the Liner Cover O-ring (37) in the groove on the large hub of the Rear Liner Cover (36). Align the pin holes in the face of the Cover with the two Liner Pins (39) at the rear of the Liner and place the Cover against the Liner. A groove will be formed between the Liner and Cover for the Rear Liner Seal (55). Do not attempt to put the Seal in the groove at this time.
11. Align the pin holes in the Front Liner Cover (47) with the Pins in the front face of the Liner and place the Cover against the face of the Liner. Another groove will be formed between the Liner and Cover for the Front Liner Seal (54). Install both the Front and Rear Liner Seals in the grooves at this time and stand the assembly on the workbench with the output end of the Drive Shaft upward.  
Refer to Dwg. TPD1312.

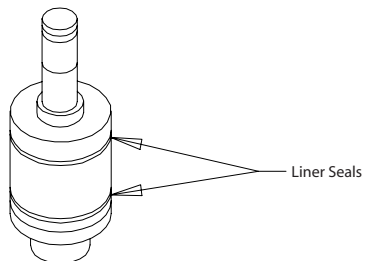

(Dwg. TPD1312)

12. Apply a thin film of grease to the Liner O-ring (34) and install it in the forward bore of the Housing.
13. Lubricate the Front and Rear Liner Seals and after orienting the Housing to the proper position, install the Housing over the Liner.
14. Grasp the flats of the Housing in vise jaws with the output spindle downward. Remove the Rear Liner Cover Assembly and put grease in the central opening of the Cover. Refer to Dwg. TPD1313.

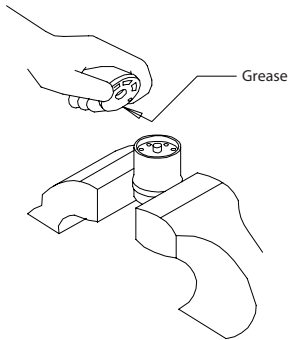

(Dwg. TPD1313)

15. Reinstall the Cover Assembly and use a hex wrench to push it below the threads at the rear of the Housing. Refer to Dwg. TPD1314.

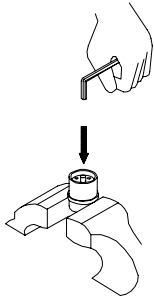

(Dwg. TPD1314)

16. Install the Housing Cap (35) and using the spanner plug furnished in the Tool Kit, tighten the Cap between 58 and 65 ft-lb (78 and 88 Nm) torque. Refer to Dwg. TPD1315.

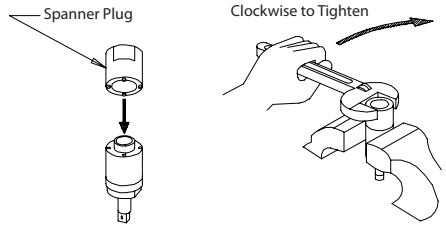

(Dwg. TPD1315)

17. Make certain the Drive Shaft rotates freely and then fill the mechanism with fluid and reassemble the tool as instructed in the section, CHANGING THE MECHANISM FLUID.

### Related Documentation

For additional information refer to:  
 Product Safety Information Manual 04584983.  
 Product Information Manual 47133053.  
 Parts Information Manual 47135652.

Manuals can be downloaded from [ingersollrandproducts.com](http://ingersollrandproducts.com)

[ingersollrandproducts.com](http://ingersollrandproducts.com)

© 2013 Ingersoll Rand

