



CR.IBGJ.CWCF.U.GSF.8

Island Buffet Refrigerated

Stone Top & Joinery Panels



Product Code:

CR	= Culinaire Refrigerated
IBGJ	= Island Buffet - Granite Top - Joinery Cladding
CWCF	= Cold Well - Counter Line - Fan Forced
U	= Under Bench
GSF	= Flat Glass Gantry - Stainless Steel Fixings
8	= 8 Modules

Optional Extras:

Condensate Burn Off Tray

- Factory fitted (If Required, must be nominated at time of order)

CR.T5.ET

Technical Data:

Dimensions: W x D x H: 3080 x 1000 x 1260
 Total Connected Load: 1.2kW
 Electrical Connection: 10A plug & lead fitted

Product Information:

- Buffet unit is fitted with an under bench cold well, CR.CWCF.U.GSF
- Adjustable digital temperature controller allows food to be held between +2°C to +4°C in a maximum of 32°C ambient temperature
- The blown air design passes cold air over and under the food pans creating an even cooling effect
- Fitted with a stainless steel gantry support frame and light surround
- 10mm toughened flat glass gantry fitted with high impact, low energy L.E.D. lighting
- Culinaire buffet units can be customised to suit any application (minimum dimensions of buffet unit shown below)
- Additional items can be incorporated into the buffet unit such as plate dispensers, plate shelves under, induction warming units, etc
- Internal framing is constructed from a heavy-duty stainless steel to endure the day to day use in a busy environment
- Heavy-duty non-marking 75mm swivel castors, two with brakes
- A ventilation grill is fitted to the base panels to ensure adequate ventilation to the refrigeration unit. Location will vary depending on the cold well size
- Removable condensate drip tray for water collection (no plumbing to waste required). Condensate container to be emptied between service periods
- Optional condensate burn off tray can be fitted to buffet unit at the time of manufacture
- Stoddart has a selection of standard stone tops and pre-finished melamine boards available, or specify finishes to suit your decor (prices may vary)

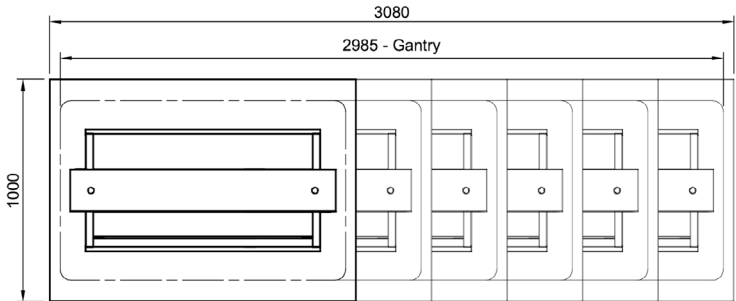

Plan View

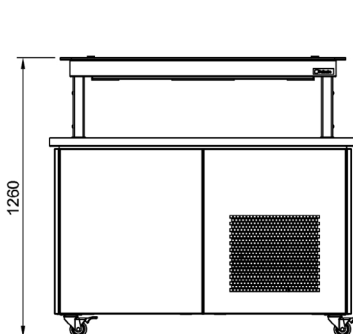

Front Elevation

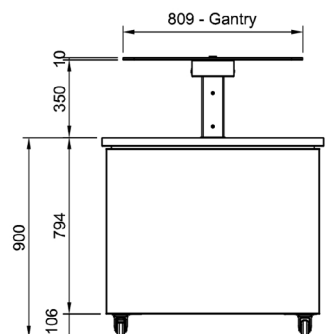

End Elevation



Proudly Manufactured in Australia

Due to continuous product research and development, the information contained herein is subject to change without notice

Manufactured By:

Tom Stoddart Pty Ltd. ABN 16 009690251
 39 Forest Way, Karawatha 4117 Queensland Australia
 Tel : +61 7 3440 7600 Fax : +61 7 33441000
 Web site: www.stoddart.com.au

