

CR.CWCF.U.GSF.5

Refrigerated Well Counter Line

Under Bench

Product Code:

CR	= Culinaire Refrigerated
CWCF	= Cold Well - Counter Line - Fan Forced
U	= Under Bench
GSF	= Flat Glass Gantry - Stainless Steel Fixings
5	= 5 Modules

Technical Data:

Dimensions: W x D x H:	1842 x 830 x 1095
Cutout Dimensions:	1735 x 545
Total Connected Load:	0.9kW
Electrical Connection:	10A plug & lead fitted

Product Information:

- This display is designed to be mounted under a custom made bench top of your choice (manufactured & fitted by others)
- Supports will be required to hold the cold well in position under the bench top
- Adjustable digital temperature controller allows food to be held between +2°C to +4°C in a maximum of 32°C ambient temperature
- The blown air design passes cold air over and under the food pans creating an even cooling effect
- Fitted with a stainless steel gantry support frame and light surround
- 10mm toughened flat glass gantry fitted with high impact, low energy L.E.D. lighting
- Gantry is detachable and height adjustable for ease of installation. To be connected by an electrician
- Fully insulated and constructed from 304 grade stainless steel with a No.4 finish
- Undermount refrigeration unit supplied with condensate drain hose for connection to waste
- Suits gastronorm pans up to 100mm deep (sold separately)

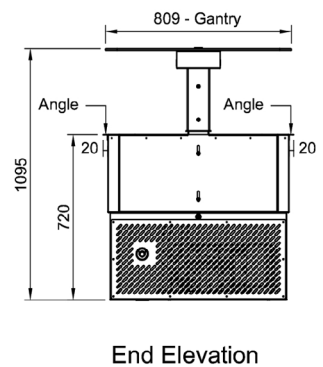
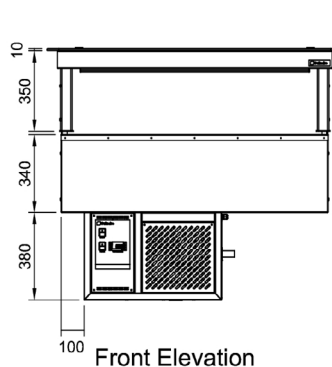
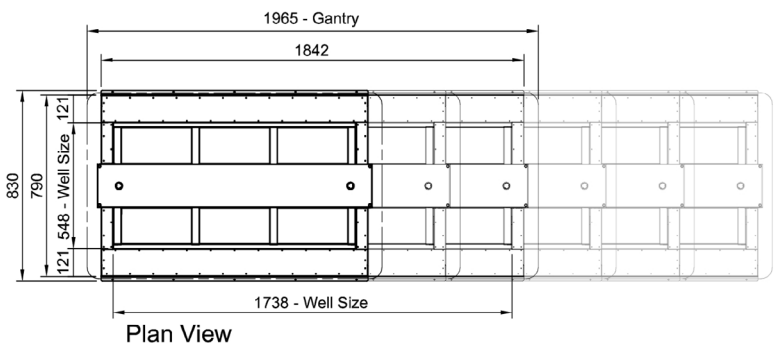

Proudly Manufactured
in Australia

Due to continuous product research and development, the information contained herein is subject to change without notice

Manufactured By:

Tom Stoddart Pty Ltd. ABN 16 009690251
39 Forest Way, Karawatha 4117 Queensland Australia
Tel : +61 7 3440 7600 Fax : +61 7 33441000
Web site: www.stoddart.com.au