



AARHP.24.4 BOILING TOPS



Model shown with optional equipment stand

TECHNICAL DATA:

Dimensions (W x D x H): 609 x 828 x 437 (1137)*
Total Weight: 63 Kg
Burners: 4 x 26MJ/Hr burners

GAS DETAILS	Natural Gas (NG)	Universal LP Gas (ULPG)
Minimum Supply Pressure	1.13 kPa	2.75 kPa
Operating Pressure	1.0 kPa	2.49 kPa
Total Gas Supply	104MJ/Hr	104MJ/Hr

3/4" BSP connection

*Height on optional stand

NOTE: It is the responsibility of the installing gas plumber to ensure correct supply and connection sustaining appropriate pressure when all appliances are full on.

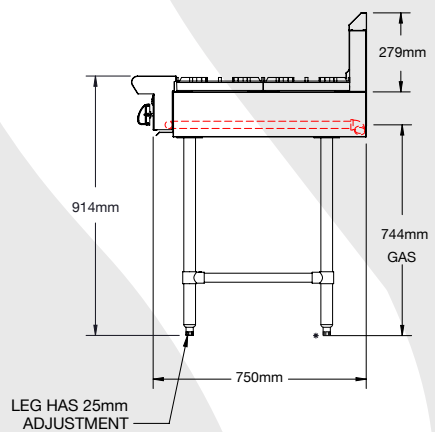
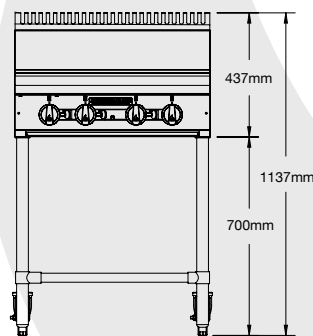
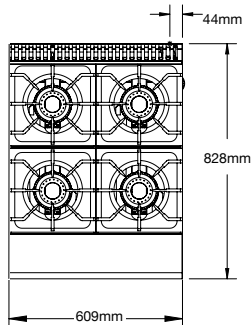

PROJECT _____
 ITEM _____
 QUANTITY _____
 DATE _____

The Boiling Top Series is designed for heavy duty use and performance. All the latest technology is incorporated to provide the best value for money.

Quality, dependability and customer satisfaction make American Range the ultimate choice.

FEATURES & BENEFITS:

- 303mm open burners
- Cast iron trivet is reversible to accept flat pans or woks
- Stainless steel front and sides
- Compact design for countertop use or with an optional stand
- Two piece, lift-off easy clean open burners
- Removable full width drip pan under open burners
- Open burner – Manually lit, No pilot, with flame failure. Simple - low maintenance

OPTIONAL EXTRAS:

- 102mm adjustable legs
- Equipment stand
- Castor kit

Due to continuous product research and development, the information contained herein is subject to change without notice.
 Revision: 15/8/2019