

# HYDROTAP G5 BC20 TOUCH-FREE WAVE CHROME



BOILING



CHILLED

FILTERED

## Order Code H5W702Z00AU

Zip HydroTap Touch-Free Wave Boiling, Chilled, Filtered water uses smart infrared 100% touch-free operation that is activated with the Wave of a hand. The water system features a single under bench command centre including full colour interactive touch screen display with pin code protection and customisable settings including boiling water safety mode, 2 energy saving modes including ON/OFF timers and 2 hour sleep mode, 'Quiet' mode with automated intelligent fan speed adjustment, antimicrobial protection impregnated into key water paths for enhanced hygiene, 100% water efficient air cooled technology and 0.2 micron water filtration.



---

Manufacturing Code	H5W702Z00AU
--------------------	-------------

---

Capacity	Commercial
----------	------------

---

Number of people	1-20
------------------	------

---

Boiling Cups per hour	100
-----------------------	-----

---

Chilled Cups per hour	75
-----------------------	----

---

---

<b>Tap</b>	Zip HydroTap Touch-Free Wave tap (Chrome)
<b>Water Pressure</b>	Min 170kPa - Max 700kPa
<b>Water Connection</b>	1/2" BSP (G1/2)
<b>Water Supply Requirements</b>	Cold
<b>Water Valves</b>	Integrated 500kPa Pressure limiting valve and Dual Check Valve
<b>Power Rating</b>	1.9kW 220-240V 50Hz
<b>Power Supply</b>	1 x 10 Amp socket outlet
<b>Dimensions</b>	W280mm x D455mm x H333mm
<b>Product Approvals</b>	WaterMark, RCM, ARC
<b>Warranty</b>	5 years (appliance warranty 36 months plus additional 24 months tank warranty)

---

## Installation Requirements

1. Installation and connection of your Zip HydroTap must be carried out by a qualified person, observing national and local regulations.
2. You will require suitable mains electrical and drinking water connections, plus waste water drainage all within 1 metre of the product.
3. Discrete cabinetry cut-outs are required for ventilation.
4. Installation on most bench tops is straightforward however some stone bench tops may require a specialised cutting service.
5. If you live in a hard water area, we recommend installation of a Zip scale filtration kit.
6. Installation by Zip Professional Service can be arranged with a phone call or through [www.zipwater.com/book-service-visit](http://www.zipwater.com/book-service-visit)

---

## Installation Detail

**Ventilation requirements** Contact your local service provider if ventilation is not suitable

**Clearance envelope**

Position the Tap and the Command Centre as close together as possible.

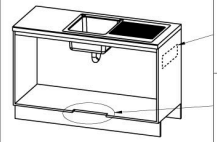
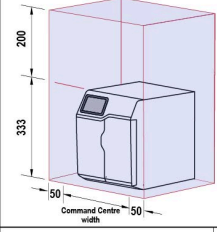

Air outlet louvre (if required)  
Cut-out in door/wall, towards the top of the cabinet

Air inlet cut-out (required)  
Cut-out in cabinet floor

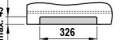
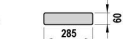

**HydroTap Tap options**

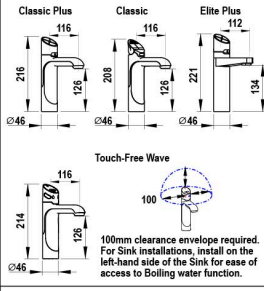

**Tap Positioning**

Position the Tap to dispense into the sink, allowing clearance for a cup or teapot. Alternatively, mount the HydroTap Tap on a Font (available as an accessory).

Ø35mm hole for HydroTap Tap



**Font options**

**Raised Font with 135mm Extension part no. 95258**

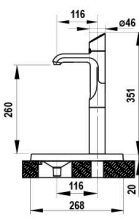

**Cutting detail**

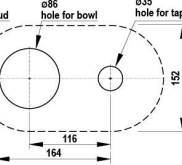

**Font with 135mm Extension part no. 90915**

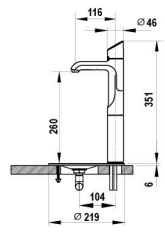

**Cutting detail**

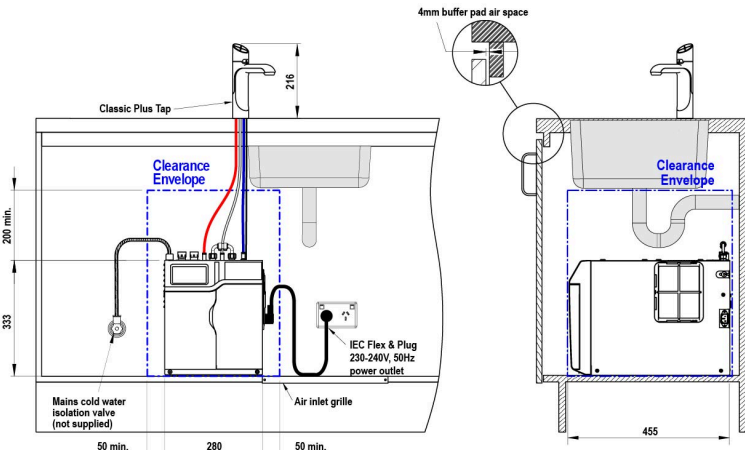
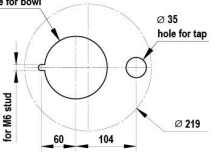

SCALE 1:5  
ALL DIMENSIONS IN MM UNLESS OTHERWISE SPECIFIED. INSTALLATION DIAGRAMS ARE FOR ILLUSTRATIVE PURPOSES ONLY. HOSES ARE NOT SHOWN TO SCALE AND CANNOT BE LENGTHENED.

**HydroTap G5  
BC20**

shown with "Classic Plus" Tap