

# HO2USS-HC

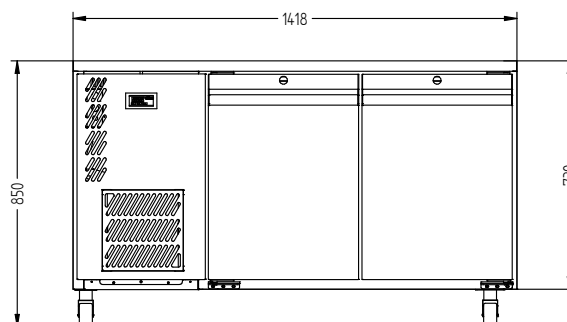

CATEGORY	HYDROCARBON
RANGE	<b>Opal</b>
UNIT	REFRIGERATOR
TYPE	SELF CONTAINED
DOORS	2

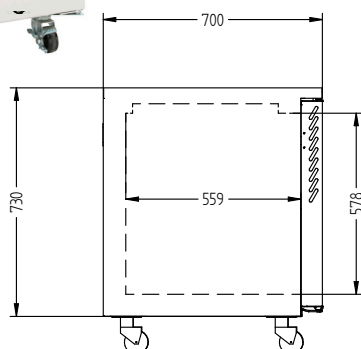
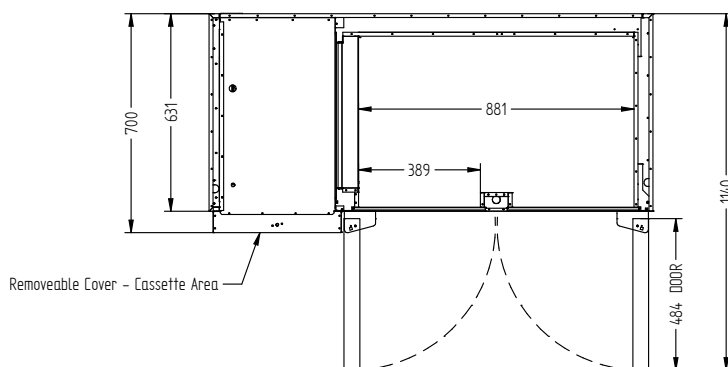

## SPECIFICATIONS

CAPACITY LITRES	350
TEMPERATURE	1°C / 4°C
FRONT BREATHING	YES
DIMENSIONS - W X D X H (ON 120 MM H CASTORS) MM	1418 W x 700 D x 850 H
WEIGHT UNPACKED (KG)	130

## STANDARD INCLUSIONS \*\*\*

DOOR TYPE	Standard: SD (Solid Door) Optional: DR (Drawer)
FINISH (INTERIOR AND EXTERIOR EXCLUDING REAR AND UNDER)	SS (Stainless Steel)
SHELVES/DOOR (ADJUSTABLE STRIPS AND CLIPS)	2

## GAS TYPE

REFRIGERANT	R290
-------------	------

## ELECTRICAL

POWER SUPPLY	10 amp
POWER CABLE LENGTH (METRES)	2
RUNNING AMPS	1.68

## PERFORMANCE

KWH/24HR READING	1.4
TEST STANDARD	EN 16825 (Professional)
TEST CONDITIONS	4 M1
AMBIENT RATING	40°C