

Bar Refrigeration

# TBR32-RISZ1-L-B-G-2

 Bar Refrigerator, Black Ext, 1 Glass Swing Door



Dimensions	
External Width (mm)	813
External Depth (mm)	631
External Height (mm)	881
Exclusions	Depth does not include 35 mm for door handle. Height does not include 7 mm for leg levelers.
Gross Volume (Litres)	290
Supplied Shelves	3
Shelf Size (L x D mm)	450 x 458
Internal Net Height (mm)	730
Unpackaged Weight (kg)	121
Packaged Weight (kg)	132
Packaged Dimensions (W x D x H mm)	991 x 724 x 1067
Supplied with	Levelling Screws. Optional castors sold seperately.

Build	
Door Description	1 Full Glass Swing Door
Door Opening	Left (standard) or Right Field Reversible
Exterior Construction	Black powder coated steel front. Matching black coated Aluminium sides & rear. Stainless steel countertop.
Interior Construction	Stainless Steel
Air Intake Position	Front
Ventilation Position	Front
Clearance Required	Zero back and sides
Cord Length (Meters)	3.04
Internal Lighting	TruLumina®
Standard w/ Locks	Standard

Technical	
Temperature Range	0.5 : 3.3°C
Refrigerant	R290
Voltage/Frequency/Phase	220-240V/50-60Hz/1
Amps	1.8
Watts	414
Defrost Type	Auto



Specifications subject to change without notice.  
Chart dimensions rounded up to the next whole millimeter (inches rounded up to the 1/8")

UK & Ireland  
EMEA  
Australia

[0800 783 2049](tel:08007832049)  
[+41 61 563 07 05](tel:+61615630705)  
[+61 2 9619 9999](tel:+61296199999)

[TFIUK@truemfg.com](mailto:TFIUK@truemfg.com)  
[TrueCHCustomerService@truemfg.com](mailto:TrueCHCustomerService@truemfg.com)  
[TrueRefAus@truemfg.com](mailto:TrueRefAus@truemfg.com)



# TBR32-RISZ1-L-B-G-2

Bar Refrigerator, Black Ext, 1 Glass Swing Door

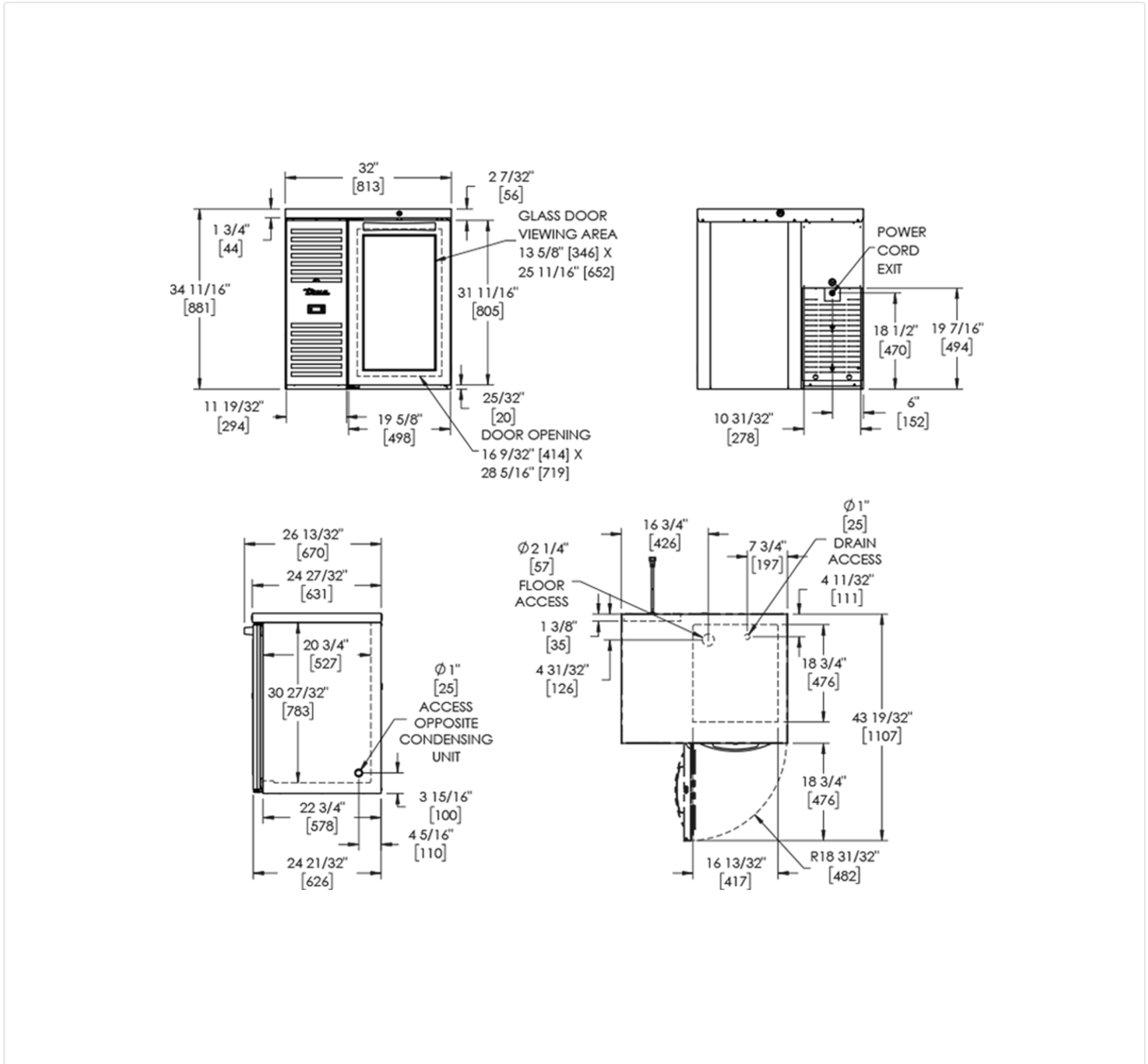

Specifications subject to change without notice.  
Chart dimensions rounded up to the next whole millimeter (inches rounded up to the 1/8")

UK & Ireland  
EMEA  
Australia

0800 783 2049  
+41 61 563 07 05  
+61 2 9619 9999

TFIUK@truemfg.com  
TrueCHCustomerService@truemfg.com  
TrueRefAus@truemfg.com

