

SB178 | 178kg Storage Bin

Ice Machines

SB178

**178KG STORAGE
BIN**

Stainless steel
internal and external
construction for
corrosion resistance
and simple cleaning

Insulated with
polyurethane to
slow melting and
maximise ice life



Agion®-treated materials
maintain hygiene with
antimicrobial technology



SB178 | 178kg Storage Bin

Ice Machines

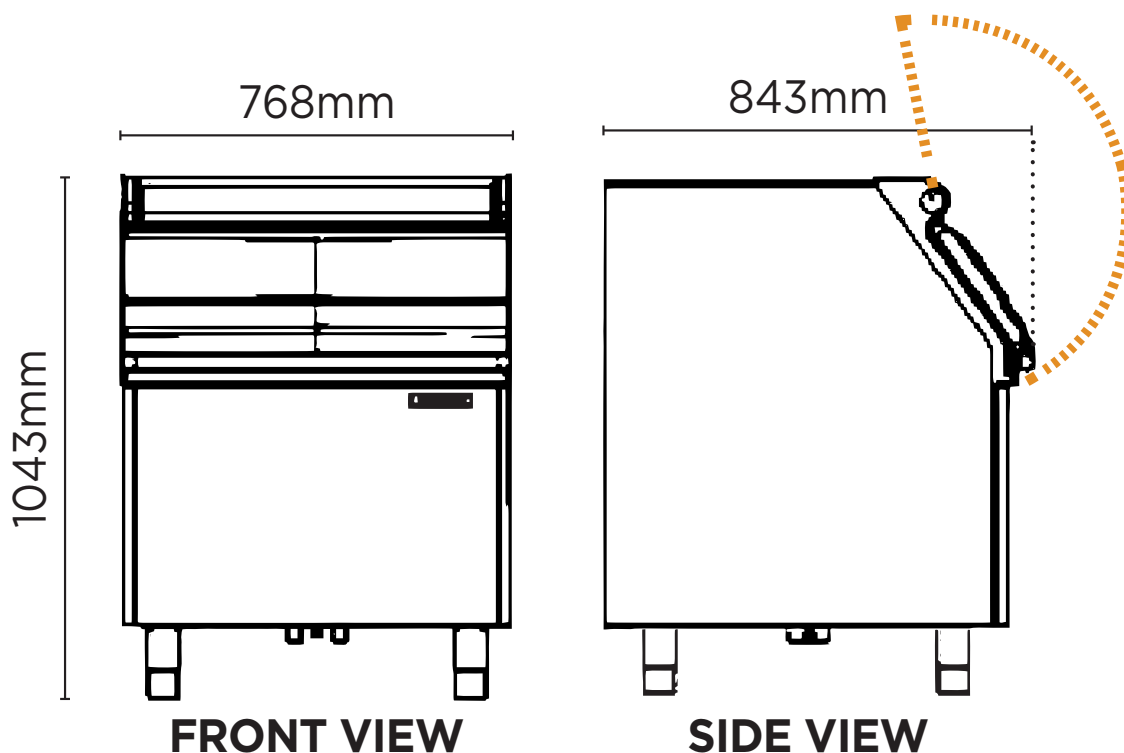

SPECIFICATIONS

Model	SB178
Part Number	3935271
Storage Bin Capacity	178kg
Gross Weight	62kg
Liner Material	Stainless Steel
Warranty	3 Years Parts, 1 Year Labour
Warranty Service	Bromic Extra Care

DIMENSIONS

	External (mm)
Width	768
Depth	843
Height	1043

* External height excludes feet
 * Production is based on kg/24hr at 10°C air & 10°C water

BROMIC PTY Ltd reserve the right to alter specifications without notice.