

Trade Waste Solutions



250mm Square Floor Waste Arrestor (suits 100mm pipe)



FW-250BS-304

FW-250BS-316

- Hinged Grate
- Heel Proof
- Fixed Strainer
- Removable Basket
- 304 or 316 Grade Stainless Steel
- Suits 100mm DWV, HDPE Pipe



FW-BASKET-100

Top

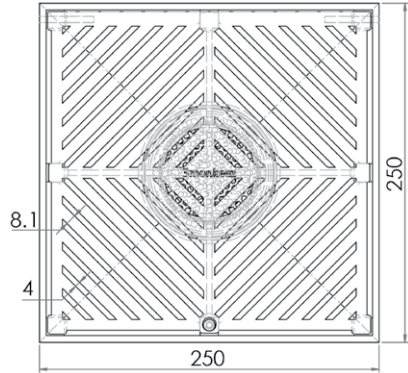

Front

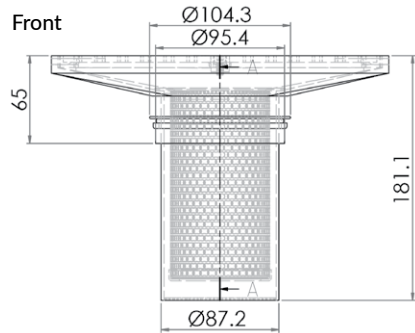

Cross Section

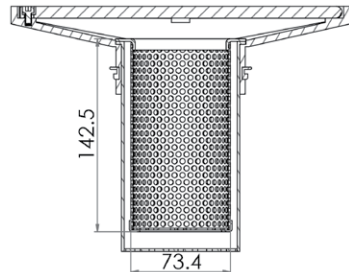

*Exclusions apply

3monkeez.com.au

