

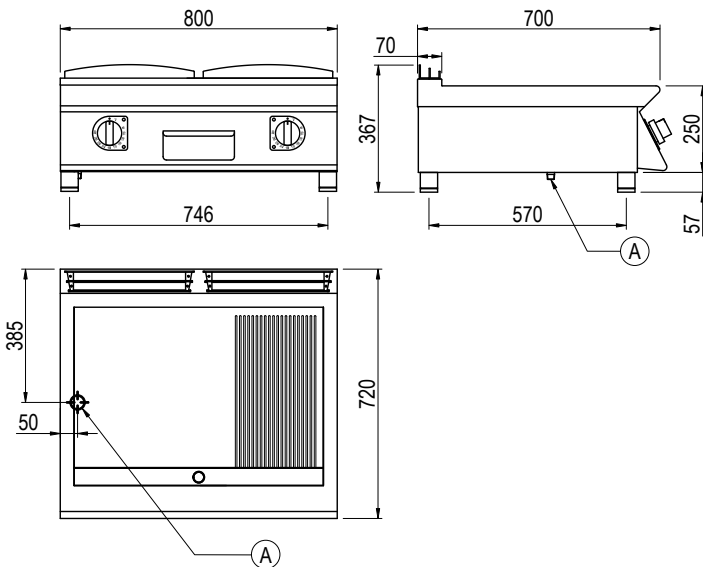

Product Information:

- Class leading, European style, professional quality and reliability since 1963
- 700 series, electric frytop with 2/3 smooth and 1/3 ribbed 12mm mild steel plate (13kW)
- Heating elements with Hi-limit temperature protection
- Temperature regulation via thermostat (80°C – 290°C)
- Indicator lights to monitor the correct operation of the appliance
- Robust 304 grade stainless steel construction with rounded corners for improved cleaning
- Hermetically sealed, pressed work surface with raised edges to protect from overflow
- Removable grease tray
- 24-month warranty

General Drawing:



Specifications:

| | |
|-------------------------------|------------------------------------|
| Model | FME741TFT |
| W x D x H (mm) | 800 x 720 x 367 |
| Weight | 80kg |
| Cooktop (mm) | 720 x 460 |
| Packed Dimensions (mm) | 845 x 825 x 570 |
| Packed Weight (mm) | 90kg |
| Electrical Connection | 3Ø + N + E 415VAC / 50Hz / 13kW |

Legend:

A Electrical Connection

