

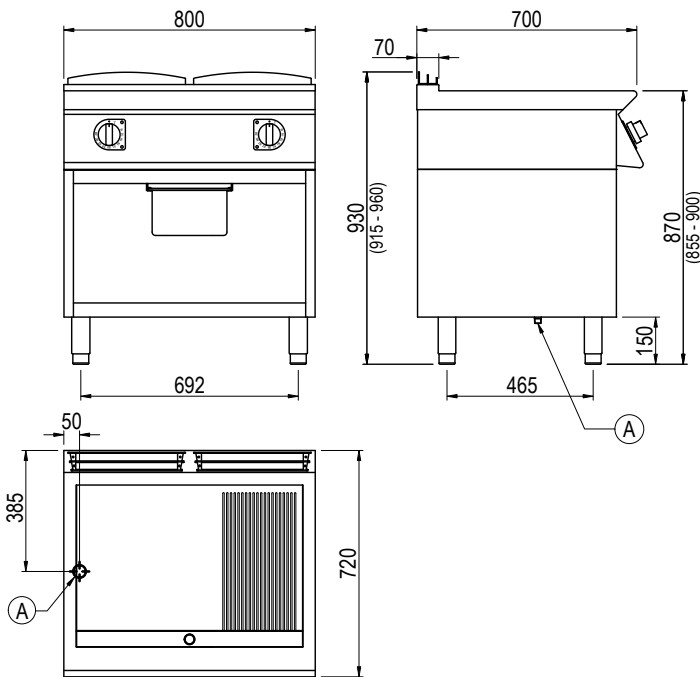

Product Information:

- Class leading, European style, professional quality and reliability since 1963
- 700 series, electric frytop with 2/3 smooth and 1/3 ribbed 12mm mild steel plate (13kW)
- Heating elements with Hi-limit temperature protection
- Temperature regulation via thermostat (80°C – 290°C)
- Indicator lights to monitor the correct operation of the appliance
- Robust 304 grade stainless steel construction with rounded corners for improved cleaning
- Hermetically sealed, pressed work surface with raised edges to protect from overflow
- Removable 1/2 GN grease tray
- Open base with optional doors available (SPGI.2016437)
- Height adjustable stainless steel feet for a 900mm working height
- 24-month warranty

General Drawing:



Specifications:

Model	FME741GFT
W x D x H (mm)	800 x 720 x 930
Weight	95kg
Cooktop (mm)	720 x 460
Packed Dimensions (mm)	845 x 825 x 1200
Packed Weight (mm)	105kg
Electrical Connection	3Ø + N + E 415VAC / 50Hz / 13kW

Legend:

A Electrical Connection

