

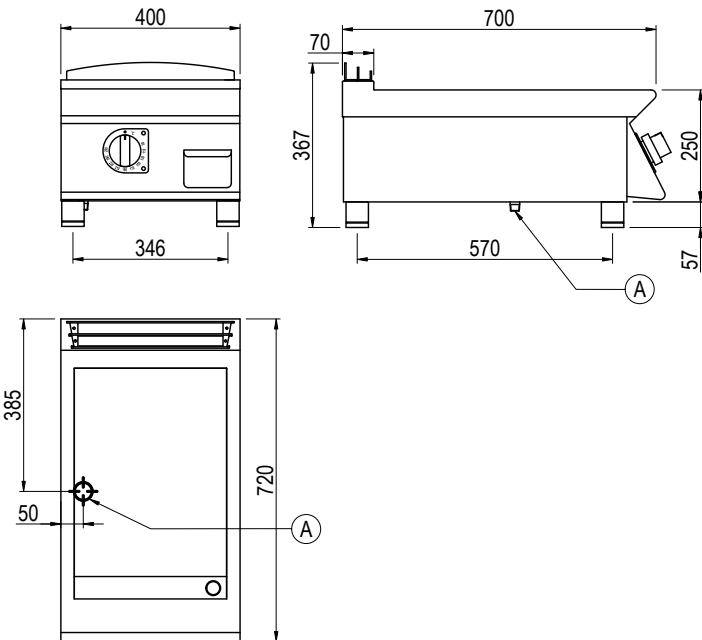

Product Information:

- Class leading, European style, professional quality and reliability since 1963
- 700 series, electric frytop with 15mm smooth satin chrome plate (6.5kW)
(also available in 15mm ribbed satin chrome plate)
- Satin chrome plate delivers a cost effective, highly durable, faster heating and easier cleaning solution than alternative plates
- Heating elements with Hi-limit temperature protection
- Temperature regulation via thermostat (80°C – 290°C)
- Indicator light to monitor the correct operation of the appliance
- Robust 304 grade stainless steel construction with rounded corners for improved cleaning
- Hermetically sealed, pressed work surface with raised edges to protect from overflow
- Removable grease tray
- 24-month warranty

General Drawing:



Specifications:

Model - Smooth	FLE72TCRXT
Model - Ribbed	FRE72TCRXT
W x D x H (mm)	400 x 720 x 367
Weight	50kg
Cooktop (mm)	340 x 460
Packed Dimensions (mm)	450 x 845 x 570
Packed Weight (mm)	55kg
Electrical Connection	3Ø + N + E 415VAC / 50Hz / 6.5kW

Legend:

A Electrical Connection

