

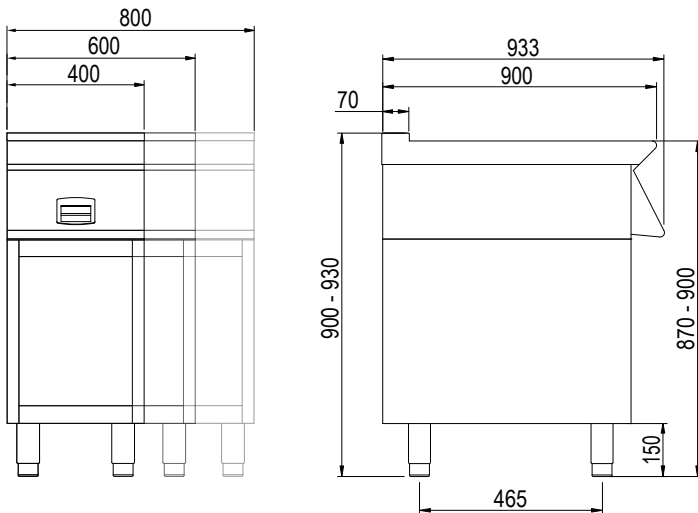

**Product Information:**

- Class leading, European style, professional quality and reliability since 1963
- 900 series, ambient worktops with drawers on open bases, available in 400, 600 and 800mm wide units
- Drawer with handle, suitable for 150mm high trays
- Robust 304 grade stainless steel construction with rounded corners for improved cleaning
- Height adjustable stainless steel feet for a 900mm working height
- Open base with optional door/s available (SPGI.2016437)
- 24-month warranty

**General Drawing:**



**Specifications:**

Model	EN92CGT
W x D x H (mm)	400 x 920 x 890
Weight	- kg

Model	EN93CGT
W x D x H (mm)	600 x 920 x 890
Weight	- kg

Model	EN94CGT
W x D x H (mm)	800 x 920 x 890
Weight	- kg