

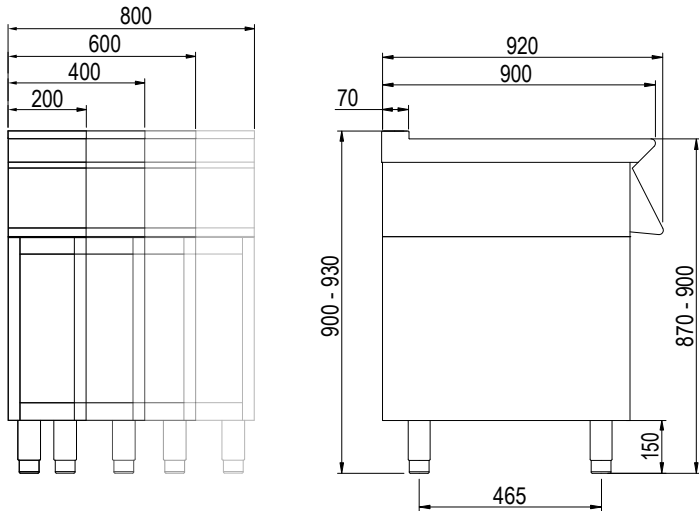

Product Information:

- Class leading, European style, professional quality and reliability since 1963
- 900 series, ambient worktops on open bases, available in 200, 400, 600 and 800mm wide units
- Robust 304 grade stainless steel construction with rounded corners for improved cleaning
- Height adjustable stainless steel feet for a 900mm working height
- Open base with optional door/s available (SPGI.2016437)
- 24-month warranty

General Drawing:



Specifications:

Model	EN910GT
W x D x H (mm)	200 x 920 x 890
Weight	- kg
Model	EN920GT
W x D x H (mm)	400 x 920 x 890
Weight	- kg
Model	EN930GT
W x D x H (mm)	600 x 920 x 890
Weight	- kg
Model	EN940GT
W x D x H (mm)	800 x 920 x 890
Weight	- kg