

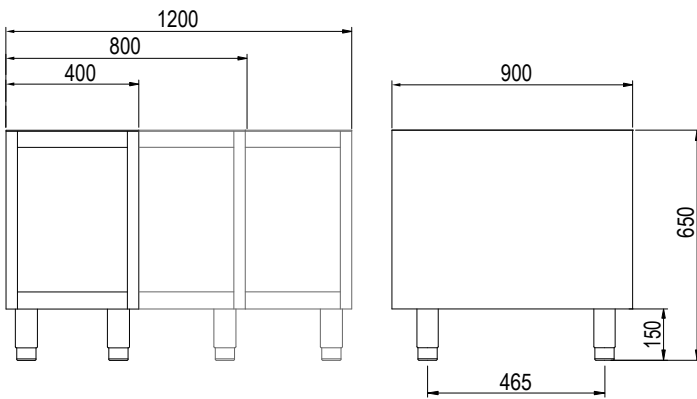

Product Information:

- Class leading, European style, professional quality and reliability since 1963
- 900 series, open base, available in 400, 800 and 1200mm wide units
- Robust 304 grade stainless steel construction with rounded corners for improved cleaning
- Height adjustable stainless steel feet for a 900mm working height
- Open base with optional door/s available (SPGI.2016437)
- 24-month warranty

General Drawing:



Specifications:

Model	BV920GT
W x D x H (mm)	400 x 833 x 650
Weight	- kg

Model	BV940GT
W x D x H (mm)	800 x 833 x 650
Weight	- kg

Model	BV960GT
W x D x H (mm)	1200 x 833 x 650
Weight	- kg