

SPIKA

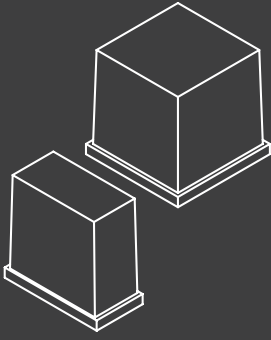

NG50 R290

Self-Contained Ice Cube Maker

Half Dice NG50 A HD R290
Full Dice NG50 A FD R290

SKOPE®

ITV | 
ICE makers



INDUSTRY
KITCHENS

www.industrykitchens.com.au 1800 611 058

Features



- 45kg ice cube production in 24 hours
- Choose between machine that produces full dice or half dice ice cubes
- 20kg ice storage capacity
- Easy access external operational switches
- Strong solid AISI 304 stainless steel box-type frame
- Easy servicing without disassembling the whole machine
- Patented robust folding door with noise reduction system
- Front and rear ventilation system allows machine to be built-in (ventilation clearances required)
- Cleaning switch allows circulation of water with descaling product (calklin or similar)
- Tropical T Class compressors suitable for use in environments up to 43°C ambient
- ITV designed motor pump, no seals to avoid deterioration
- R290 Natural Refrigerant with very low global warming impact which also reduces energy consumption
- 2 year warranty
- **Installation must be carried out by a qualified plumber or refrigeration mechanic**



R290 Natural Refrigerant

Supplied Accessories



Water Inlet
Hose



Drain Hose



Gasket
Washers



Medium
Scoop



Adjustable
height legs

Backflow prevention
device

Water Filter



A Watermark approved* water filter, suitable for the water type at the place of installation must be used. SKOPE can provide a water filter that protects the Ice Maker, and ensures proper function and high quality ice production. Service or repair due to absence of a suitable water filter will not be covered by SKOPE warranty. Contact SKOPE for more information.

*Watermark approval is only applicable to Australian installations. Elsewhere, a suitable water filter must be used.

Machine Specifications

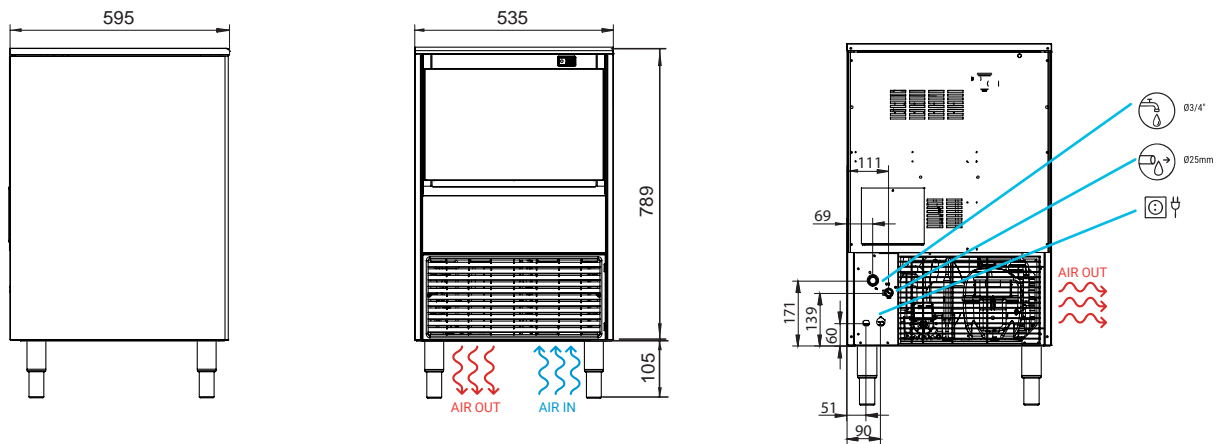

Machine dimensions 535 x 595 x 789mm/894-944 with legs

Packed dimensions 610 x 655 x 910mm

Machine weight 53kg









Packed weight 57kg

Floor area 0.36m²

Ventilation recommendations

- 100mm behind the cabinet
- 100mm above the cabinet

Optional castor height 62mm

							
(W)	(Btu/h)	(W) 43°C	(n.) (mm ²)	FUSE	(Kwh)	(l/h)	(W) (Btu/h)
	615 2,098	240	3 1.5	16	15.3	FULL 2.7 HALF 2.7	465 1,587

Ice Specifications



Ice dimensions	FULL 26 x 23 x 26mm
	HALF 23 x 11 x 26mm
Ice cube volume	FULL 12cc
	HALF 6cc
Ice cubes per cycle	FULL 75
	HALF 150
Ice cube storage capacity	20kg

Ice production per 24 hour cycle (kg)

		Water temperature			
		10°C	15°C	21°C	30°C
Air temperature	10°C	52	49	46	42
	21°C	48	45	42	38
	32°C	40	37	35	31
	43°C	32	28	23	20



Electrical Safety & EMC
Regulatory Compliance Mark



2 Year Warranty Protection
Parts & Labour

SKOPE INDUSTRIES LIMITED

Australian Freephone: 1800 121 535

New Zealand Freephone: 0800 947 5673

Email: skope@skope.com

Website: www.skope.com