



Food Preparation Machines
Made in Sweden



Vegetable Preparation Machine

Vegetable Preparation Machine RG-50

- Slices, dices, shreds, grates, cuts julienne and crimping slices.
- Processes fruit, vegetables, dry bread, cheese, nuts, mushrooms, etc.
- Table top machine made for smaller kitchens.
- Processes up to 80 portions/day and 2 kg/minute.



RG-50



Ergonomics in all stages

RG-50 is the most compact vegetable preparation machine from HALLDE. It is developed to suite smaller kitchens and the compact design makes RG-50 easy to put away and bring back when needed. The machine is a table top and can be used directly on the kitchen workbench. RG-50 pusher plate is swung up in a bow shape angle. This together with the low height makes for a better working posture.

Safe and quick top ups

Thanks to the automatic start and stop function the machine stops as soon as the pusher plate is swung up. When it is swung back the machine restarts and you can continue working. A clear advantage, particularly when larger volumes are involved.

Double safety against unprotected blades

If the feed cylinder is removed the power is cut. Thanks to this double security there is no risk of the machine starting with an unprotected blade.

Developed for the best hygiene

The RG-50 is manufactured solely from hygiene certified material. The machine has smooth surfaces, rounded edges and has no unnecessary recesses where food might penetrate and get stuck.

Easy cleaning

For quick cleaning are all loose parts simple to remove for easy rinsing of the machine. The feed cylinder is removable and can be washed in a dishwasher.

Only the best material

The machine base is made of robust ABS-plastic, the feed cylinder and pusher plate are made of strong polycarbonate. Only top quality stainless steel is used to manufacture the cutting tool knife blades.

Lightweight and easy to move

The small size of the machine gives several advantages. It does not take up a lot of space in the kitchen. And it is easy to move, something which is helped by the generously sized handles on the sides.

Highest possible reliability

The powerful motor has a high starting and running torque and powers the cutting tool via a self-tensioning belt. The motor speed is geared down which makes the RG-50 an exceptionally reliable machine – irrespective of the products you are preparing.

Cutting tools with complete register

Our wide range of cutting tools means the RG-50 can handle every conceivable task. You choose the cutting tool you need to make you even more efficient in the kitchen. The RG-50 slices, dices, grates/shreds, cuts juliennes and crimping slices – everything from firm to soft products.

Always perfect cutting results

The rotation speed of the cutting tools is optimised for cutting fine and even slices as efficiently as possible. The blades are purposely sharpened to avoid inertia or the edge breaking off.



Accessories



2-pack Cutting Tools



4-pack Cutting Tools





















Wall Rack/ Cutting Tool Hanger

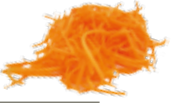
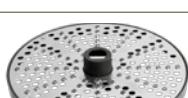

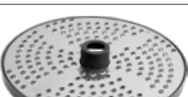
Brush

High quality cutting tools for best results

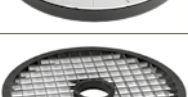
All cutting tools are dishwasher safe. * = Stainless steel

	Slicer * 1, 2, 4, 6 * 0.5, 1.5, 3, 5, 7, 8, 9, 10, 15 mm.	Are designed to slice firm and soft vegetables, fruits, mushrooms etc. Dices when combined with a suitable Dicing Grid. Cut French fries in combination with Potato Chip Grid.	
	Fine Cut Slicer * 15 mm.	Are designed to slice firm and soft vegetables, fruits, mushrooms etc. Dices when combined with a suitable Dicing Grid.	
	Soft Slicer * 8, 10, 12, 15 mm.	Are designed to slice soft vegetables, fruits, mushrooms etc. Preferably used when dicing soft products, in combination with a suitable Dicing Grid.	
	Crimping Slicer * 4 mm. * 2, 3, 5, 6 mm.	Cut decorative rippled slices of beetroot, cucumber, carrots, etc.	
	Julienne Cutter * 2x2, 4x4 mm. * 2x6, 3x3 mm.	Cut julienne of firm products for soups, salads, stews, decorations etc. Suitable to cut slightly curved French fries.	
	Grater/Shredder 2, 4, 6 mm. * 1.5, 3, 4.5, 8, 10 mm.	Grates carrots and cabbage for raw salads. Grates nuts, almonds and dry bread. Grater 6 or 8 mm is commonly used for grating cheese for pizza and when shredding cabbage.	
	* Fine Grater	For finely grating products, from hard/dry cheeses, raw potatoes for Swedish potato pancakes and bread for making breadcrumbs.	
	* Hard Cheese Grater	Ideal for grating hard cheese such as parmesan. Produces a somewhat coarser grate than the Fine Grater, Extra fine.	
	* Fine Grater, Extra Fine	Grates products very finely, such as black radish grated for purée and potatoes for mashing.	
	Dicing Grid * 8x8, 10x10, 12x12, 15x15, 20x20 mm.	Are designed to cut dices in combination with a suitable type of slicer. Dice both hard and soft vegetables, fruits etc.	

* Cutting Tools from RG-100 also fits RG-50.



Take a look at result- and inspiration videos at our homepage, hallde.com ►





Vegetable Preparation Machine RG-50

- Large half-moon shaped feed cylinder that can take most items whole.
- Compact table top model that takes up little space but is in spite of its size a very flexible machine. RG-50 can do what HALLDE's larger machines do with the same good quality.
- Easy piling of tomatoes, onions, bell peppers etc. for oriented slicing.
- Self tensioning and geared belt driven motor gives a high torque.
- Machine base is completely in ABS-plastic and holds for rough handling.
- 42 cutting tools.

Machine

- Motor: 1.0 kW. One-speed. 120 V, single phase, 60 Hz. 220-240 V, single phase, 50-60 Hz.
- Transmission: Toothed belt.
- Safety system: Two safety switches.
- Degree of protection machine: IP34.
- Power supply socket: Earthed, single phase, 10 A.
- Fuse: 10 A, delayed action fuse.
- Sound level LpA (EN31201): 76 dBA.
- Magnetic field: Less than 15 microtesla.

Materials

- Machine base: ABS-plastic
- Knife chamber: Aluminium.
- Feeder: Polycarbonate and polyamide.
- Ejector plate: Acetal.
- Cutting tool disks: Stainless steel.
- Cutting tool knives: Stainless steel.

Feeder

- Feed cylinder: Volume 0.9 litre. Height 185 mm. Diameter 170 mm.
- Feed tube with internal diameter 53 mm.

Cutting tools

- Diameter: 185 mm.
- Speed: 500 rpm (50 Hz).

Type of preparation

- Slices, dices, grates, shreds, cuts julienne and crimping slices.
- Processes vegetables, fruit, dry bread, cheese, nuts, mushrooms etc.

Users

- Restaurants, shop kitchens, cafés, bakeries, diet kitchens, retirement homes, schools, fast food outlets, day care centres, salad bars, etc.

Net weights

- Machine: 8.6 kg.
- Cutting plates: 0.3 kg.

Standards

- NSF/ANSI Standard 8.
- Other directives: Visit hallde.com. Select product and "Certification".

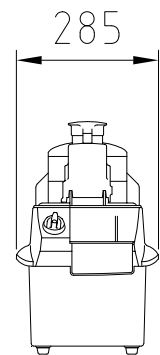
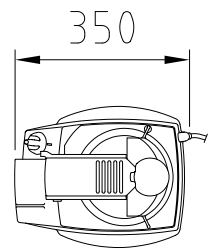
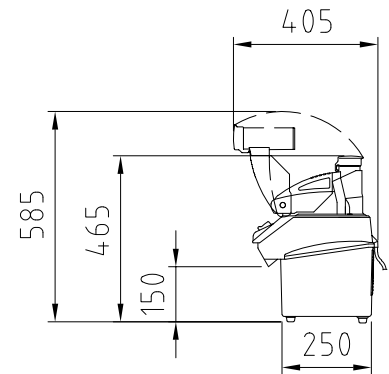

Food Preparation Machines
Made in Sweden

Available Australia wide from

FSM

21-23 Agosta Drive, Laverton North, Victoria 3026
Tel: (03) 9368 2300
www.fsm-pl.com.au sales@fsm-pl.com.au

Office and warehouse facilities in Melbourne, Sydney, Adelaide, Brisbane & Perth - *Service Australia Wide*

AB Hallde Maskiner - P.O. Box 1165 SE-164 26 Kista Sweden
• Phone: +46 8 587 730 00 • Fax: +46 8 587 730 30 • hallde.com • info@hallde.com