



800 SERIES CHAR BROILER

RBA12L - Gas

- Heavy duty cast iron reversible grates provide greater control when cooking and energy efficiency
- Heavy duty fully welded steel body ensures rigidity and durability
- Stainless steel fascia and sides, spill zone and drip tray for ease of cleaning
- Pilot light standard maximising operating and energy efficiency
- Option of drop on griddle plate provides greater flexibility when cooking

Other options

Stand or bench mounted

Without splash back

Drop-on griddles 230, 270 or 410mm wide

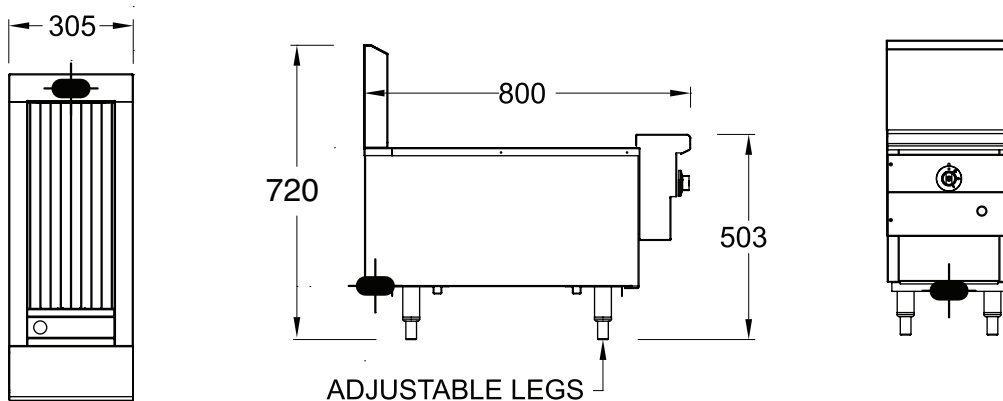

RBA12L

SPECIFICATIONS

Dimensions (WxDxH)	305 x 800 x 720 mm
Grill size (WxD)	215 x 546 mm
Gas connection	1/2" BSP

1/2" BSP Gas Connection

Rating	37 MJ
Weight	48 kg
Packed	0.2 m ³

Australia's premier food service
equipment manufacturer

goldstein.com.au

211-217 Woodpark Road, Smithfield NSW 2164
1800 013 123 | +61 2 9604 7333

 **MIDDLEBY AUSTRALIA**

