

# INDUSTRY KITCHENS

www.industrykitchens.com.au 1800 611 058

The logo for POLAR, featuring the word "POLAR" in a bold, blue, sans-serif font. A white triangle is positioned above the letter "A". The logo is set against a dark grey rounded rectangular background.

## Counter Refrigerator/ Freezer

Instruction manual



**Model:**

**UA005-A/UA006-A/UA007-A/UA008-A**

## Safety Instructions

Please take a few moments to carefully read through this manual. Correct maintenance and operation of this machine will provide the best possible performance from your POLAR product.

- Position on a flat, stable surface.
- A service agent/qualified technician should carry out installation and any repairs if required.
- Consult Local and National Standards to comply with the following:
  - Health and Safety at Work Legislation
  - Fire Precautions
  - Wiring Regulations
  - Building Regulations
- DO NOT use jet/pressure washers to clean the appliance.
- DO NOT use the appliance outside.
- DO NOT use this appliance to store medical supplies.
- DO NOT allow oil or fat to come into contact with the plastic components or door seal. Clean immediately if contact occurs.
- DO NOT store products on top of the appliance.
- Bottles that contain a high percentage of alcohol must be sealed and placed vertically in the refrigerator.
- Always carry, store and handle the appliance in a vertical position and move by holding the base of the appliance.
- Always switch off and disconnect the power supply to the appliance when not in use.
- Keep all packaging away from children. Dispose of the packaging in accordance to the regulations of local authorities.
- Children should be supervised to ensure that they do not play with the appliance.

- This appliance is not intended for use by persons (including children) with reduced physical, sensory or mental capabilities, or lack of experience and knowledge, unless they have been given supervision or instruction concerning the use of the appliance by a person responsible for their safety.
- Polar recommend that this appliance should be periodically tested (at least annually) by a Competent Person. Testing should include, but not be limited to: Visual Inspection, Polarity Test, Earth Continuity, Insulation Continuity and Functional Testing.

**Warning: Risk of Fire / flammable materials** 

- Do not store explosive substances such as aerosol cans with a flammable propellant in this appliance.



**Warning: Keep all ventilation openings clear of obstruction. Unit should not be boxed in without adequate ventilation.**

- **Warning:** Do not use mechanical devices or other means to accelerate the defrosting process, other than those recommended by the manufacturer.
- **Warning:** Do not damage the refrigerant circuit.
- **Warning:** Do not use electrical appliances inside the food storage compartments of the appliance, unless they are the type recommended by the manufacturer.

## Product Description

**UA005-A** - Polar 2 door Counter Refrigerator

**UA006-A** - Polar 2 door Counter Freezer

**UA007-A** - Polar 3 door Counter Refrigerator

**UA008-A** - Polar 3 door Counter Freezer

## Introduction

Please take a few moments to carefully read through this manual. Correct maintenance and operation of this machine will provide the best possible performance from your POLAR product.

## Pack Contents

The following is included:

- POLAR Refrigerator / Freezer
- Keys
- Shelves
- Shelf support bars
- Instruction Manual

POLAR prides itself on quality and service, ensuring that at the time of packaging the contents are supplied fully functional and free of damage.

Should you find any damage as a result of transit, please contact your POLAR dealer immediately.

## Installation



**Note: If the appliance has been stored or moved in a non-vertical position, stand it in an upright position for approximately 12 hours before operation. If in doubt allow to stand.**

1. Remove the appliance from the packaging and remove the protective film from all surfaces.
2. To optimize performance and longevity, ensure a minimum clearance of 2.5cm is maintained between the unit and walls and other objects, with a minimum 5cm clearance on the top.

**NEVER LOCATE NEXT TO A HEAT SOURCE.**



**Note: Before using the appliance for the first time, clean the shelves and interior with soapy water.**

3. Set the brakes on the castors to keep the appliance in position.

## Fitting the shelf support bars

- Place the support bar on the ladder at the desired height. For installation, the closed end shall be located at rear and open end at front.
1. Push the support bar backwards to let its rear end hang on the rear ladder (Step 1).
  2. Lift the front end slightly then buckle it onto the front ladder (Step 2).

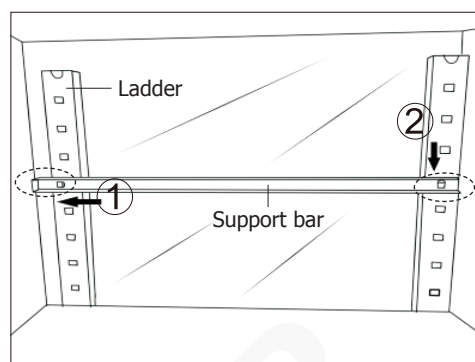

- Repeat for the remaining support bars.
- Slide the GN pans/shelves into place.

## Operation

### Control Panel for refrigerators (UA005-A/UA007-A)





### Control Panel for Freezers (UA006-A/UA008-A)



### Turn On

1. Close the door/doors of the appliance.
2. Connect the appliance to the mains power supply.
3. To switch system on or off, press and hold  for 3 seconds.



### Adjusting the Temperature

1. Press  for 3 seconds. The set temperature on the display will flash.
2. Press  or  to change the set temperature.
3. Wait 6 seconds for the set temperature to be stored.



### Manual Defrost



**Automatic defrost:**  
The appliance features an automatic defrost. However, should the appliance require an additional defrost period, carry out below operations:

1. Press  for 3 seconds to enter defrosting mode. The symbol  will appear on the display.
2. Press  for 3 seconds again to exit.

### Short cut operations for refrigerators only:

1. Press  once to enter fish mode and display the set temperature (Range: -1°C ~ 1°C).
2. Press  once to enter meat mode and display the set temperature (Range: -2°C ~ 2°C).
3. Press  once to return to general mode and display the set temperature (Range: 1°C ~ 4°C).

## Cleaning, Care & Maintenance



**Switch off and disconnect from the power supply before cleaning the condenser.**

- Clean the interior of the appliance as often as possible.
- Do not use abrasive cleaning agents. These can leave harmful residues.
- Clean the door seals with warm soapy water.
- Always wipe dry after cleaning.



**Note: Condensation will form in refrigeration on hot humid days, please ensure condensation is allowed to drain properly or is wiped dry.**

### Cleaning the condenser (annually)

- **The refrigerator is fitted with a self cleaning condenser that reduces the need for maintenance. However, annual checks are advised.**
- **The condenser is part of the refrigeration system. The condenser requires annual cleaning.**
- **When to clean the condenser, please Call POLAR agent or qualified Technician.**
- **Always disconnect power supply before carrying out routine maintenance.**
- **Failure to clean the condenser will reduce the performance and life of your unit and may invalidate your warranty.**

### Cleaning the filter (monthly)

1. These models have a removable filter which can be taken out for cleaning.
2. Open the left hand door.
3. The filter tab will be visible behind the lower hinge. Pull this tab to remove the filter.
4. Clean the filter with a vacuum cleaner.
5. Replace the filter and close the door.

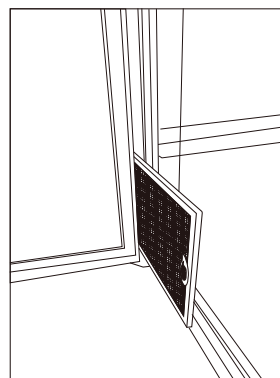
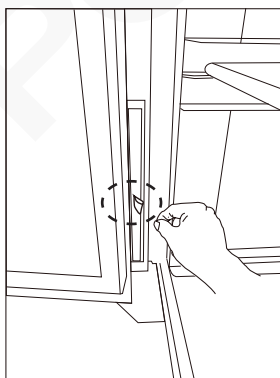
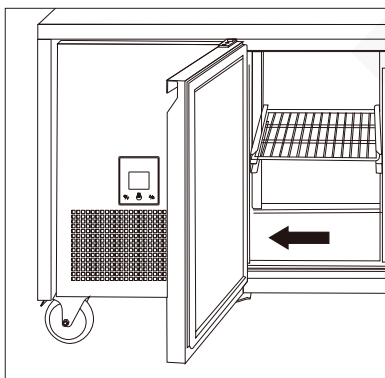

## Troubleshooting

If the machine malfunctions due to causes other than those listed or the proposed corrective actions do not solve the problem please call a Polar agent or qualified technician. A POLAR agent or qualified technician must carry out repairs if required.

Fault	Probable Cause	Solution
The unit is not working	The unit is not switched on	Check the unit is plugged in correctly and switched on
	Plug or lead is damaged	Replace plug or lead
	Mains power supply fault	Check mains power supply
The appliance is not cooling	Coolant Leak	Call POLAR agent or qualified technician
	Fan Motor Failed	Call POLAR agent or qualified technician
	Airflow to the condenser obstructed	Increase the gap between appliance and obstacles/heat source
	Condenser is clogged	→ <b>Cleaning the condenser</b>
Loud noises	Appliance is not level	Adjust position to make it level
	Appliance is too close to a wall or other object	Move to a more suitable location
Odour from the unit	Unit is not cleaned for long time	Clean the unit thoroughly
	Odour food not properly packed	Seal and pack odour food properly

Error code/ indication	Probable Cause	Solution
"ER1" and alarm	The evaporator inlet probe is faulty	Press any button to cease alarm. Call POLAR agent or qualified Technician to replace the faulty probe
"ER2" and alarm	The evaporator return gas probe is faulty	Press any button to cease alarm. Call POLAR agent or qualified Technician to replace the faulty probe
"ER3" and alarm	The defrost probe (evaporator temperature probe) is faulty	Press any button to cease alarm. Call POLAR agent or qualified Technician to replace the faulty probe
"ER4" and alarm	Door not closed properly or door switch is faulty	Press any button to cease alarm. Close the door/doors properly or check the door switch
"ER5" and alarm	Condenser probe is faulty	Press any button to cease alarm. Call POLAR agent or qualified Technician to replace the faulty probe
"SO" and alarm	Cabinet temperature probe is open-circuited	Press any button to cease alarm. Call POLAR agent or qualified Technician to replace the faulty probe
"SC" and alarm	Cabinet temperature probe is short-circuited	Press any button to cease alarm. Call POLAR agent or qualified Technician to replace the faulty probe
"HI" and alarm	Condenser temperature exceeding 60°C	Power off and re-start machine to cease alarm. Press power button  for 1 second to check the condenser temperature on the screen. Clean the condenser filter immediately, or Call POLAR agent or qualified technician

## Technical Specifications

Model	Voltage	Power (W)	Temp. Range	Refrigerant	Dimensions H x W x D mm	Weight (kg)
UA005-A	220-240V~ 50Hz	350	-2°C ~ +4°C	R290	850 x 1420 x 660	94.20
UA006-A	220-240V~ 50Hz	605	-18°C ~ -22°C	R290	850 x 1420 x 660	99.00
UA007-A	220-240V~ 50Hz	465	-2°C ~ +4°C	R290	850 x 1885 x 660	117.00
UA008-A	220-240V~ 50Hz	670	-18°C ~ -22°C	R290	850 x 1885 x 660	123.80

## Electrical Wiring

The plug is to be connected to a suitable mains socket.

This appliance is wired as follows:

- Live wire (coloured brown) to terminal marked L
- Neutral wire (coloured blue) to terminal marked N
- Earth wire (coloured green/yellow) to terminal marked E

The appliances must be earthed.



If in doubt consult a qualified electrician.

Electrical isolation points must be kept clear of any obstructions. In the event of any emergency disconnection being required they must be readily accessible.

## Compliance

The product must not be disposed of as household waste. To help prevent possible harm to human health and/or the environment, the product must be disposed of in an approved and environmentally safe recycling process. For further information on how to dispose of this product correctly, contact the product supplier, or the local authority responsible for waste disposal in your area.

POLAR parts have undergone strict product testing in order to comply with regulatory standards and specifications set by international, independent, and federal authorities.

POLAR products have been approved to carry the following symbol:



**All rights reserved. No part of these instructions may be produced or transmitted in any form or by any means, electronic, mechanical, photocopying, recording or otherwise, without the prior written permission of POLAR.**

**Every effort is made to ensure all details are correct at the time of going to press, however, POLAR reserve the right to change specifications without notice.**

# DECLARATION OF CONFORMITY

• Conformiteitsverklaring • Déclaration de conformité • Konformitätserklärung • Dichiarazione di conformità •  
• Declaración de conformidad

Equipment Type • Uitrustingstype • Type d'équipement • Gerätetyp • Tipo di apparecchiatura • Tipo de equipo	Model • Modèle • Modell • Modello • Modelo	
U series Premium 2 Door Counter Refrigerator U series Premium 2 Door Counter Freezer U series Premium 3 Door Counter Refrigerator U series Premium 3 Door Counter Freezer	UA005 (-E & -A) UA006 (-E & -A) UA007 (-E & -A) UA008 (-E & -A)	
Application of Territory Legislation & Council Directives(s) Toepassing van Europese Richtlijn(en) • Application de la/des directive(s) du Conseil • Anwendbare EU-Richtlinie(n) • Applicazione delle Direttive • Aplicación de la(s) directiva(s) del consejo	Machinery Directive 2006/42/EC Supply of Machinery (Safety) Regulations 2008 EN 60335-1:2012 +A11:2014 +A13:2017 EN 60335-2-89:2010 +A1:2016 EN 62233:2008 Electro-Magnetic Compatibility (EMC) Directive 2014/30/EU - recast of 2004/108/EC Electromagnetic Compatibility Regulations 2016 (S.I. 2016/1091) EN 55014-1: 2017 EN55014-2:2015 EN 61000-3-2: 2014 EN 61000-3-3:2013 Ecodesign requirements for professional refrigerated storage cabinets (EU) 2015/1095 EN 16825:2016 Restriction of Hazardous Substances Directive (RoHS) 2015/863 amending Annex II to Directive 2011/65/EU Restriction of the Use of Certain Hazardous Substances in Electrical and Electronic Equipment Regulations 2012 (S.I. 2012/3032)	Electrical Safety IEC 60335-1:2010 +A1:2013 +A13:2016 IEC 60335-2-89:2010 +A1:2012 +A2:2015 EN 62233:2008  Electromagnetic Compatibility EN 55014-1: 2017 EN55014-2:2015 EN 61000-3-2: 2014 EN 61000-3-3:2013
Producer Name • Naam fabrikant • Nom du producteur • Name des Herstellers • Nome del produttore • Nombre del fabricante	Polar	

I, the undersigned, hereby declare that the equipment specified above conforms to the above Territory Legislation, Directive(s) and Standard(s).

Ik, de ondergetekende, verklaar hierbij dat de hierboven gespecificeerde uitrusting goedgekeurd is volgens de bovenstaande Richtlijn(en) en Standaard(en).

Je soussigné, confirme la conformité de l'équipement cité dans la présente à la / aux Directive(s) et Norme(s) ci-dessus

Ich, der/die Unterzeichnende, erkläre hiermit, dass das oben angegebene Gerät der/den oben angeführten Richtlinie(n) und Norm(en) entspricht.

Il sottoscritto dichiara che l'apparecchiatura di sopra specificata è conforme alle Direttive e agli Standard sopra riportati.

El abajo firmante declara por la presente que el equipo arriba especificado está en conformidad con la(s) directiva(s) y estándar(es) arriba mencionadas.

Date • Data • Date • Datum • Data • Fecha • Data

12<sup>th</sup> November 2021

Signature • Handtekening • Signature • Unterschrift Firma • Firma

DocuSigned by:

*Ashley Hooper*

B39382C9FD9C478...

DocuSigned by:

*Eoghan Donnellan*

D352874F7FAB460...

DocuSigned by:

*Nerida Pearse*

8769F07756845D...

Full Name • Volledige naam • Nom et prénom • Vollständiger Name • Nome completo • Nombre completo

Ashley Hooper

Eoghan Donnellan

Nerida Pearse

Position • Functie • Fonction • Position • Qualifica • Posición

Technical & Quality Manager

Commercial Manager/ Importer

Commercial Manager/ Responsible Supplier

Producer Address • Adres fabrikant • Adresse du producteur • Anschrift des Herstellers • Indirizzo del produttore • Dirección del fabricante

Fourth Way,  
Avonmouth,  
Bristol,  
BS11 8TB  
United Kingdom

42 North Point  
Business Park  
New Malloy Road  
Cork  
Ireland

15 Bagdally Road,  
Campbelltown  
NSW 2560









<http://www.polar-refrigerator.com/> 

UA005-A to UA008-A\_A5\_v1\_20211228