

Viking 4G Electric Combi Jacketed Kettle

Viking 4G COMBI 60E (4224202)

Standard Features

- Kettle with integrated mixer
- 60 litre capacity
- Electric heated version
- Elevated control pillar with selected features
- Mixing speed control 20-110 rpm/min, autoreverse
- Two mixing programs
- Electric tilting – tilting height 600mm
- Auto tilt-back
- Safety grid lid
- Measuring stick
- Retractable handshower
- Strainer plate
- Stainless steel construction
- Unit shown includes free standing floor kit - other options available

Please refer to Moffat price list for options and accessories

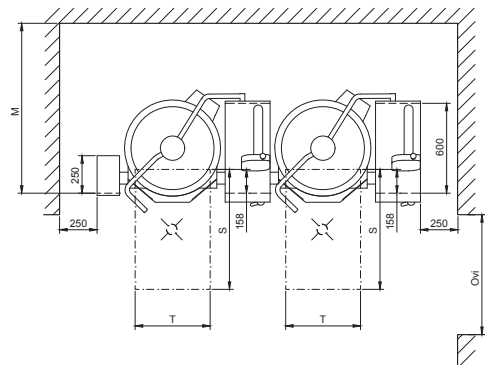
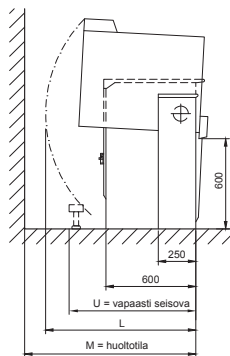
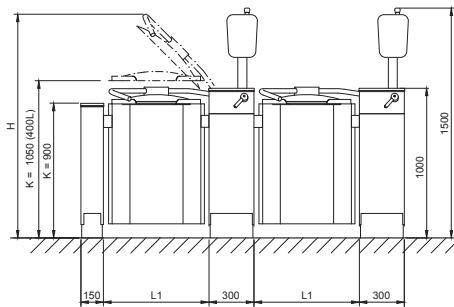

Technical Data

Net Volume 60 L
Spare Volume 8 L
Gross Volume 68 L

Dimensions

Width 1047mm
Height 1500mm
Depth 706mm

Connections

Water Cold ø15mm
Hot ø15mm

Electrical Power 12.5 kW
Voltage 400-415V,
3P+N+E 50/60Hz
AMP 25A

Total Heat Load 12.5 kW
Latent 0.6 kW,
Sensible 2.6 kW

Waste By kitchen contractor
Nett Weight 205 kg

Model	L1 mm	H mm	L mm	M mm	U mm	T mm	Door mm
60E	597	1740	870	1055	860	400	800

Australia
moffat.com.au
Moffat Pty Limited
740 Springvale Road
Mulgrave
Victoria 3170
Australia
Telephone +613-9518 3888
Facsimile +613-9518 3833
vsales@moffat.com.au

New Zealand
moffat.co.nz
Moffat Limited
45 Illinois Drive
Izone Business Hub
Rolleston 7675
New Zealand
Telephone +64 3-983 6600
Facsimile +64 3-983 6660
sales@moffat.co.nz



Disclaimer: All unit capacities are based on subjective testing. Moffat accepts no liability for production values. In line with policy to continually develop and improve its products, Moffat Limited reserves the right to change specifications and design without notice.

© Copyright Moffat Ltd
AN-MET-S-2001