

Viking 4G Steam Combi Jacketed Kettle

Viking 4G COMBI 200S (4224230)

Standard Features

- Kettle with integrated mixer
- 200 litre capacity
- Steam heated version
- Elevated control pillar with selected features
- Mixing speed control 20-110 rpm/min, autoreverse
- Two mixing programs
- Electric tilting – tilting height 600mm
- Auto tilt-back
- Safety grid lid
- Measuring stick
- Retractable handshower
- Strainer plate
- Stainless steel construction
- Unit shown includes free standing floor kit - other options available

Please refer to Moffat price list for options and accessories

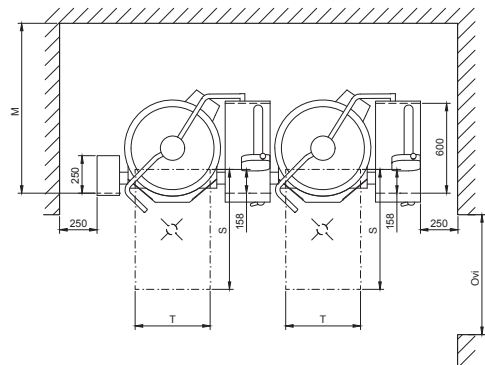
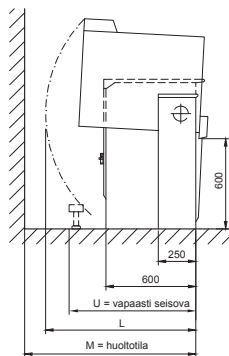
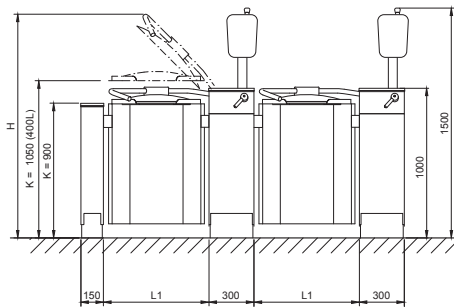

Technical Data

Net Volume 200 L
Spare Volume 19 L
Gross Volume 219 L

Dimensions

Width 1360mm
Height 1500mm
Depth 880mm

Connections

Water Cold ø15mm
Hot ø10mm
Steam R 1½" 60 kg/hr
Cond. Outlet R ¾"

Electrical Power 3.6 kW
Voltage 400-415V,
3P+N+E 50/60Hz
AMP 16A
Total Heat 30 kW
Load Latent 1.4 kW,
Sensible 6.1 kW
Waste By kitchen
contractor
Nett Weight 340 kg

Model	L1 mm	H mm	L mm	M mm	U mm	T mm	Door mm
200S	910	1945	1075	1170	1110	600	1000

Australia
moffat.com.au
Moffat Pty Limited
740 Springvale Road
Mulgrave
Victoria 3170
Australia
Telephone +613-9518 3888
Facsimile +613-9518 3833
vsales@moffat.com.au

New Zealand
moffat.co.nz
Moffat Limited
45 Illinois Drive
Izone Business Hub
Rolleston 7675
New Zealand
Telephone +64 3-983 6600
Facsimile +64 3-983 6600
sales@moffat.co.nz



Disclaimer: All unit capacities are based on subjective testing. Moffat accepts no liability for production values. In line with policy to continually develop and improve its products, Moffat Limited reserves the right to change specifications and design without notice.

© Copyright Moffat Ltd
AN-MET-S-2001