

# Viking 4G Electric Combi Jacketed Kettle

## Viking 4G COMBI 150E (4224208)

### Standard Features

- Kettle with integrated mixer
- 150 litre capacity
- Electric heated version
- Elevated control pillar with selected features
- Mixing speed control 20-110 rpm/min, autoreverse
- Two mixing programs
- Electric tilting – tilting height 600mm
- Auto tilt-back
- Safety grid lid
- Measuring stick
- Retractable handshower
- Strainer plate
- Stainless steel construction
- Unit shown includes free standing floor kit - other options available

Please refer to Moffat price list for options and accessories

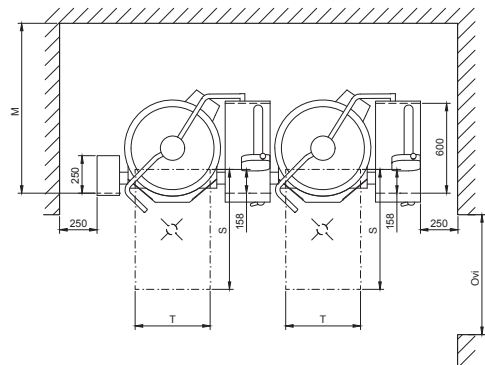
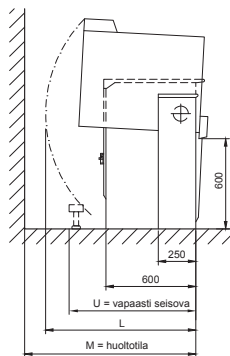
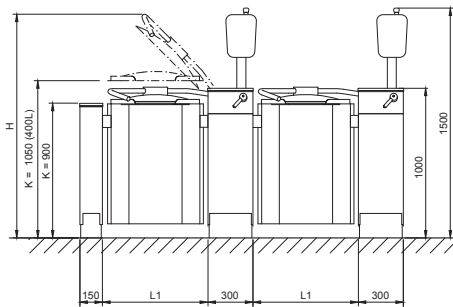

### Technical Data

Net Volume 150 L  
Spare Volume 19 L  
Gross Volume 169 L

#### Dimensions

Width 1360mm  
Height 1500mm  
Depth 880mm

#### Connections

Water Cold ø15mm  
Hot ø15mm

Electrical Power 23.6 kW  
Voltage 400-415V,  
3P+N+E 50/60Hz  
AMP 50A

Total Heat 23.6 kW  
Load Latent 1.0 kW,  
Sensible 4.3 kW

Waste By kitchen contractor  
Nett Weight 300 kg

Model	L1 mm	H mm	L mm	M mm	U mm	T mm	Door mm
150E	910	1945	1075	1170	1110	600	1000

**Australia**  
[moffat.com.au](http://moffat.com.au)  
**Moffat Pty Limited**  
740 Springvale Road  
Mulgrave  
Victoria 3170  
Australia  
Telephone +613-9518 3888  
Facsimile +613-9518 3833  
[vsales@moffat.com.au](mailto:vsales@moffat.com.au)

**New Zealand**  
[moffat.co.nz](http://moffat.co.nz)  
**Moffat Limited**  
45 Illinois Drive  
Izone Business Hub  
Rolleston 7675  
New Zealand  
Telephone +64 3-983 6600  
Facsimile +64 3-983 6660  
[sales@moffat.co.nz](mailto:sales@moffat.co.nz)



Disclaimer: All unit capacities are based on subjective testing. Moffat accepts no liability for production values. In line with policy to continually develop and improve its products, Moffat Limited reserves the right to change specifications and design without notice.

© Copyright Moffat Ltd  
AN-MET-S-2001