

Single Pan Electric Multi Pan

JUMP 101 - 100 LITRE



- 100 litre single pan capacity
- 2 x 1/1 GN pan size
- 43dm² cooking surface
- 280mm depth pan
- Multi pan for cooking, frying, braising, grilling, searing, broiling and sous-vide cooking
- Automatic basket lifting
- Automatic water filling system with accuracy of 1 decilitre
- Electromechanical tray tilting at variable speed
- 10" colour touch screen for intuitive operation and cook progress display
- Automatic and manual meal preparation mode with memory for 350 programs with 20 steps
- Four point core temperature probe
- Integrated retractable hand shower

Overall Construction

- Base frame with 3mm 304 grade stainless steel
- Frame cover with 304 grade stainless steel
- Tray with 3mm 316 grade stainless steel
- Special sandwich design pan base
- Stainless steel SUPER BLOCK JPX 17 full area heat distribution system
- Robust double insulated cover with automatic lifting function
- Excessive steam exhaust on cover
- Integrated 230V / 16A socket
- Retractable switchboard panel on right pillar allowing integration of multiple pans in a single block

Controls

- Fast base preheating
- Temperature range from 30°C-250°C
- Accurate sensory measurement of temperature
- Liquid level gauge
- Integrated drainage in the tray bottom with automatic closure
- Preset technological procedures

- Automatic extension of baskets - allows operation with cover closed
- Safety sensor for basket arm detection
- Fault messages shown on display
- Water pressure controller
- HACCP recording
- USB port for data backup

Cleaning and Servicing

- Easy clean stainless steel surface
- Easy services access from front and top sides
- Technical and service information on display

Single Pan Electric Multi Pan

JUMP 101 - 100 LITRE

Specifications

Dimensions

Width 1350mm
Depth 850mm
Height 1030mm

Capacity

100 litre

Nett weight

460kg

Packing data

560kg
Width 1480mm
Depth 1080mm
Height 1220mm

Electrical rating

400-415V, 3P+N+E, 50Hz, 32A
Energy consumption: 25.5kW

Water connection requirements

Inlet connection: R 3/4
Water outlet connection: Ø 50

Installation conditions

(for precise installation instructions
please refer to our installation manual)



moffat.com.au
moffat.co.nz

Australia

moffat.com.au

Moffat Pty Limited

Victoria/Tasmania
740 Springvale Road
Mulgrave, Victoria 3170
Telephone +613-9518 3888
Facsimile +613-9518 3833
vsales@moffat.com.au

New South Wales

Telephone +612-8833 4111
nswsales@moffat.com.au

South Australia

Telephone +613-9518 3888
vsales@moffat.com.au

Queensland

Telephone +617-3630 8600
qldsales@moffat.com.au

Western Australia

Telephone +618-9413 2400
wasales@moffat.com.au

New Zealand

moffat.co.nz

Moffat Limited

Rolleston
45 Illinois Drive
Izone Business Hub
Rolleston 7675
Telephone +64 3-983 6600
Facsimile +64 3-983 6660
sales@moffat.co.nz

Auckland

Telephone +64 9-574 3150
sales@moffat.co.nz

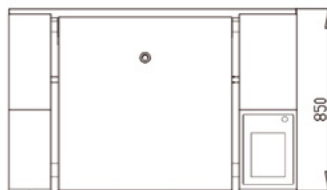
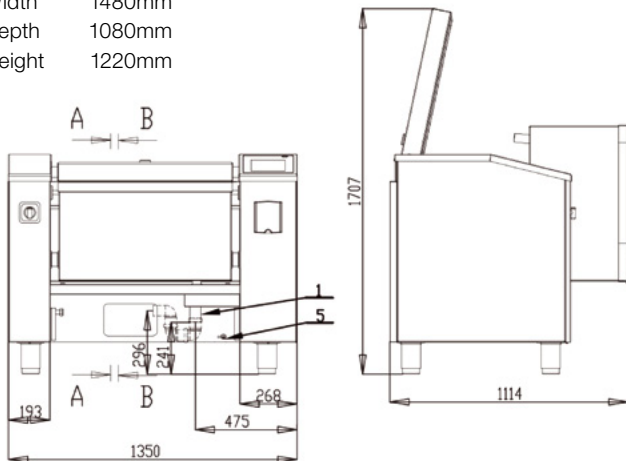

- 1 Drain DN 50
- 2 Water Inlet 3/4"
- 3 Power Connection
- 4 LAN Jack RJ 45
- 5 Equipotential Bonding

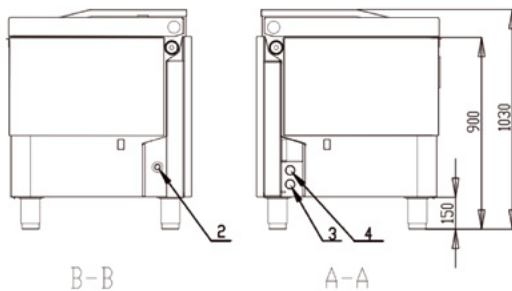

Copyright Moffat Ltd.
AN.WJ.2021