

## GAS GRIDDLE 450mm

GP513-B, GP513-CB, GP513-LS

- Heavy-duty thermostatic gas griddle
- 20mm thick griddle plate
- Ribbed plate option
- Mirror chromed plate option
- Top weld sealed plates
- 40MJ thermostatic burner system
- 2 models of base unit
- Rear rollers
- Stainless steel exterior
- Easy clean
- Easy service
- Fully modular



GP514-LS

### Overall Construction

#### Griddle

- 20mm thick machined top plates standard
- Optional full width ribbed plate section
- Optional full width mirror finish hard chrome plate
- 2.5mm thick 304 stainless steel splash guards sides and rear
- 40MJ single 3 bar even heat burner with single thermostatic control
- Full pilot and flame failure protection with piezo ignition
- Welded hob surround with 1.5mm 304 stainless steel bull nose
- Side panels 1.2mm 304 stainless steel
- Splashback 1.2mm 304 stainless steel
- Vitreous enamelled control panel
- Stainless steel grease drawer
- Overlapping finish at front and rear of plate for easy clean

#### Bench mount (supplied as -B model)

- Four 63mm dia. heavy-duty 1.2mm 304 stainless steel bench legs with adjustable feet.
- Adjustable height 80mm – 105mm

#### Cabinet base (supplied as -CB model)

- Fully modular for matched suite finish
- Double skin 0.9mm 304 stainless steel interior and exterior
- GN 1/1 4 position racking
- 63mm dia. heavy-duty 1.2mm 304 stainless steel legs with two adjustable feet at front and two rollers at rear

#### Leg stand (supplied as -LS model)

- Fully modular for matched suite finish
- Framed top for connection to Griddle
- 63mm dia. heavy-duty 1.2mm 304 stainless steel legs with two adjustable feet at front and two rollers at rear
- Fully modular framed stand shelf with 0.9mm 304 stainless steel finish
- Quick assembly design

### Controls

- 90-300°C thermostat
- Large easy use control knob - heat resistant reinforced
- Easy view control settings on knob
- Flame failure pilot burner
- Piezo ignition to pilot burner
- Over-temperature safety cut-out

### Cleaning and Servicing

- All models with easy clean stainless steel external finish
- Plate is finished front and rear with overlap construction to remove cleaning traps
- Control service and gas conversion through front of unit
- Burner service requires plate removal

# GAS GRIDDLE 450mm

GP513-B, GP513-CB, GP513-LS

### Specifications

#### Burner

3 bar chromed steel burner with pilot, flame failure and piezo ignition

#### Gas power

40MJ/hr, 11.1kW

#### Plate

Cooking surface 442mm x 530mm, 2343cm<sup>2</sup>

#### Gas connection

R 3/4 (BSP) male

All units supplied with Natural and LP gas regulators

### Dimensions

#### Bench model

Weight 77kg

Width 450mm

Depth 812mm

Height 315mm

Incl. splashback 485mm

#### Cabinet Base / Leg Stand models

Weight 90kg

Width 450mm

Depth 812mm

Height 915mm

Incl. splashback 1085mm

### Packing data

#### Bench model

0.29m<sup>3</sup>, 111kg

Width 870mm

Depth 495mm

Height 665mm

#### Cabinet Base / Leg Stand models

0.54m<sup>3</sup>, 130kg

Width 870mm

Depth 495mm

Height 1255mm

### Gas types

Available in Natural gas and LP gas,

please specify when ordering

Units supplied complete with gas type

conversion kits

Other gas types on request

### Options

Adjustable feet at rear

Joining caps

Castors

Full width ribbed plate option

Full width mirror chromed plate option

GP513-B

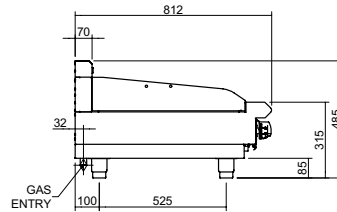
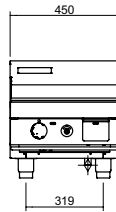

GP513-LS

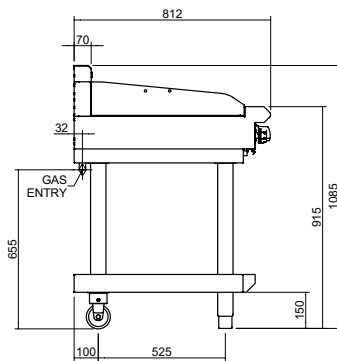
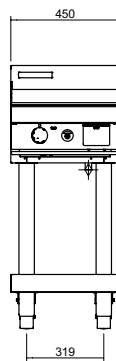

GP513-CB

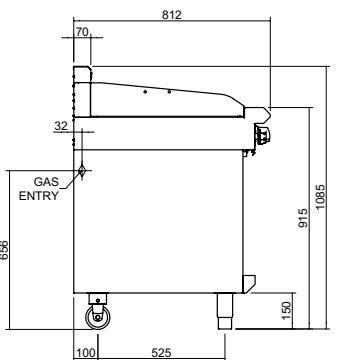
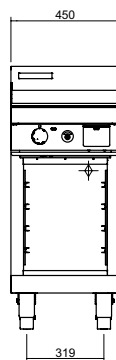

PLAN

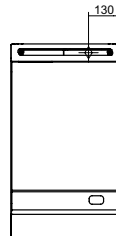

moffat.com.au

moffat.co.nz

Australia

moffat.com.au

Moffat Pty Limited

Victoria/Tasmania  
740 Springvale Road  
Mulgrave, Victoria 3170  
Telephone +613-9518 3888  
Facsimile +613-9518 3833  
vsales@moffat.com.au

New South Wales  
Telephone +612-8833 4111  
nswsales@moffat.com.au

South Australia  
Telephone +613-9518 3888  
vsales@moffat.com.au

Queensland  
Telephone +617-3630 8600  
qldsales@moffat.com.au

Western Australia  
Telephone +618-9413 2400  
wasales@moffat.com.au

New Zealand

moffat.co.nz

Moffat Limited

Rolleston  
45 Illinois Drive  
Izone Business Hub  
Rolleston 7675  
Telephone +64 3-983 6600  
Facsimile +64 3-983 6660  
sales@moffat.co.nz

Auckland  
Telephone +64 9-574 3150  
sales@moffat.co.nz



Cert. No. 6898

In line with policy to continually develop and improve its products, Moffat Limited reserves the right to change specifications and design without notice.

© Copyright Moffat Ltd  
AN.BSE.01.19/1620