

# PI150-98ET

## 90 IPERLOTUS ELECTRIC KETTLE

Electric indirect boiling pan 135 lts. Tank Ø  
cm. 60x54h (included 1 Head end filler strip  
mod.TPA-9)



Construction - Fabricated using CrNi 18/10 AISI 304 grade Stainless Steel Scotch-Brite Satin polish Finish, incorporating 2mm thick worktop, rounded edges, chromed details and rear splash back. Knobs with waterproof grades IPX5. Model - Professional Electric Kettle, possible automatic water-charge of double jacket. Indirect and autoclave versions available. From 100 to 140 liters tank constructed in AISI 304 with AISI 316 bottom. Easy and safe open and closing system. Thermostatic control. Maintenance - All serviceable parts are accessible by the easy removal of front control panel. Fittings - Appliance is supplied with adjustable feet.



ITALIAN CULINARY ART

The pictures are purely representative. The manufacturer reserves the right to modify the technical data and models without previous notice.

# PI150-98ET

90 IPERLOTUS  
ELECTRIC KETTLE

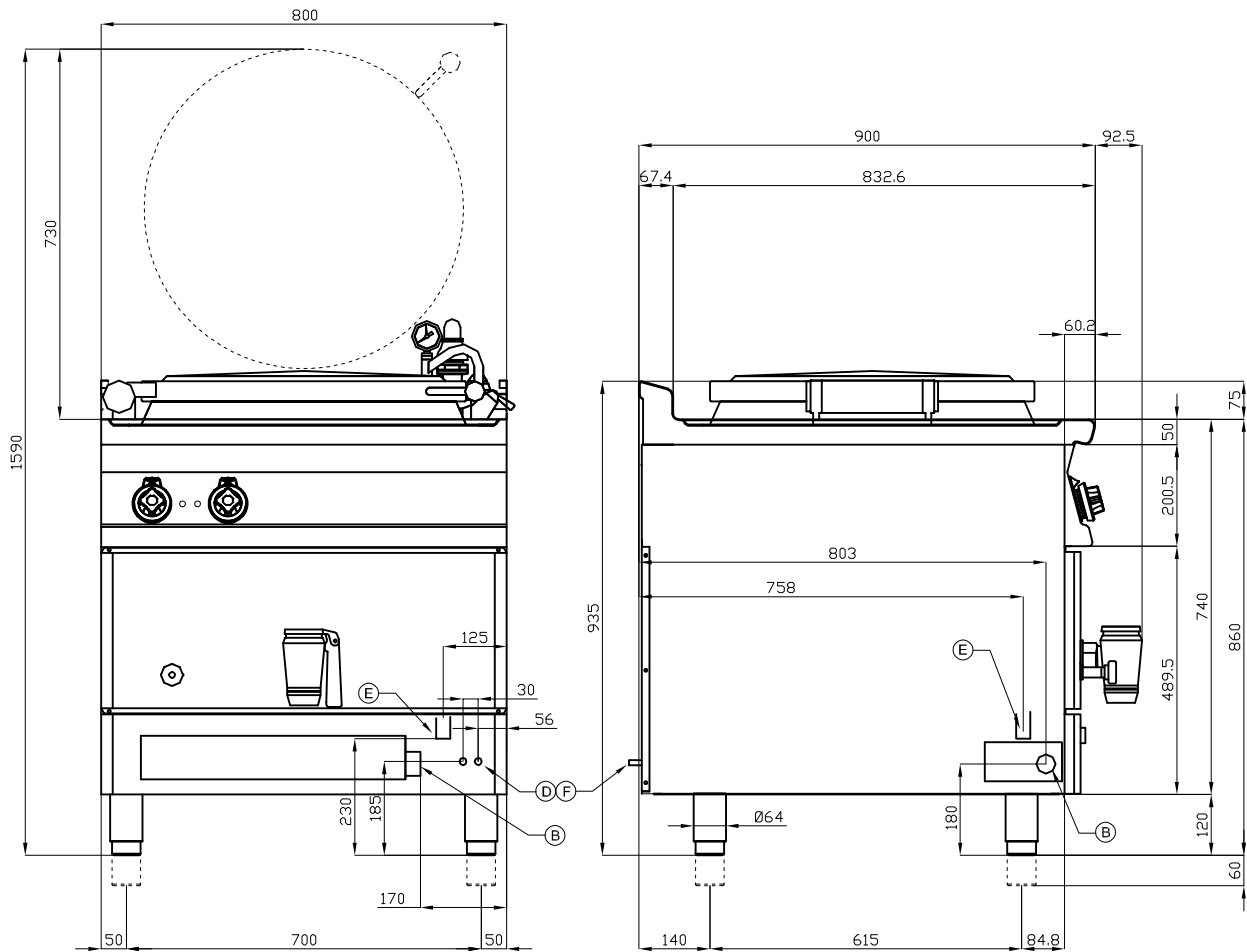

A	Data plate		B	Electrical connection	
D	Cold water connection	Ø10mm	E	Water drainage	Ø25mm
F	Hot water connection	Ø10mm			

MODEL: PI150-98ET  
 DIMENSIONS: cm. 80x 90x 90h  
 ELECTRIC POWER: 18 kW  
 VOLTAGE: 400V~3N  
 FREQUENCY: 50/60 Hz



kg: 110  
 m<sup>3</sup>: 1.071  
 mm: 870x1070x1150

BUY LOTUS BUY ITALY

The pictures are purely representative. The manufacturer reserves the right to modify the technical data and models without previous notice.



LOTUS S.P.A. Via Calmaor, 46  
 31020 San Vendemiano(TV) - Italy  
 Tel. + 39 0438 778020 / 778468  
 Fax + 39 0438 778277  
 www.lotuscookers.it - lotus@lotuscookers.it