

BR80-98ETF/I

90 IPERLOTUS

ELECTRIC TILTING BRATTPANS

Braising pan with manual tilting, bowl 80 lt.
cm.72x56x22,5h, Stainless steel bottom with
lid



Construction - Fabricated using CrNi 18/10 AISI 304 grade Stainless Steel Scotch-Brite Satin polish Finish, incorporating 2mm thick worktop, rounded edges, chromed details and rear splash back. Tanks bottom in stainless steel. Knobs with waterproof grades IPX5. Model - Professional Electric Tilting Bratt Pan (80°) with highly accurate manual or motorised 80 - 120ltr tank with highly efficient conductive base. Water tap and hinged cover, thermostatically controlled up to 300deg C.. Fittings - Appliance is supplied with adjustable feet.



ITALIAN CULINARY ART

The pictures are purely representative. The manufacturer reserves the right to modify the technical data and models without previous notice.

BR80-98ETF/I

90 IPERLOTUS

ELECTRIC TILTING BRATTPANS

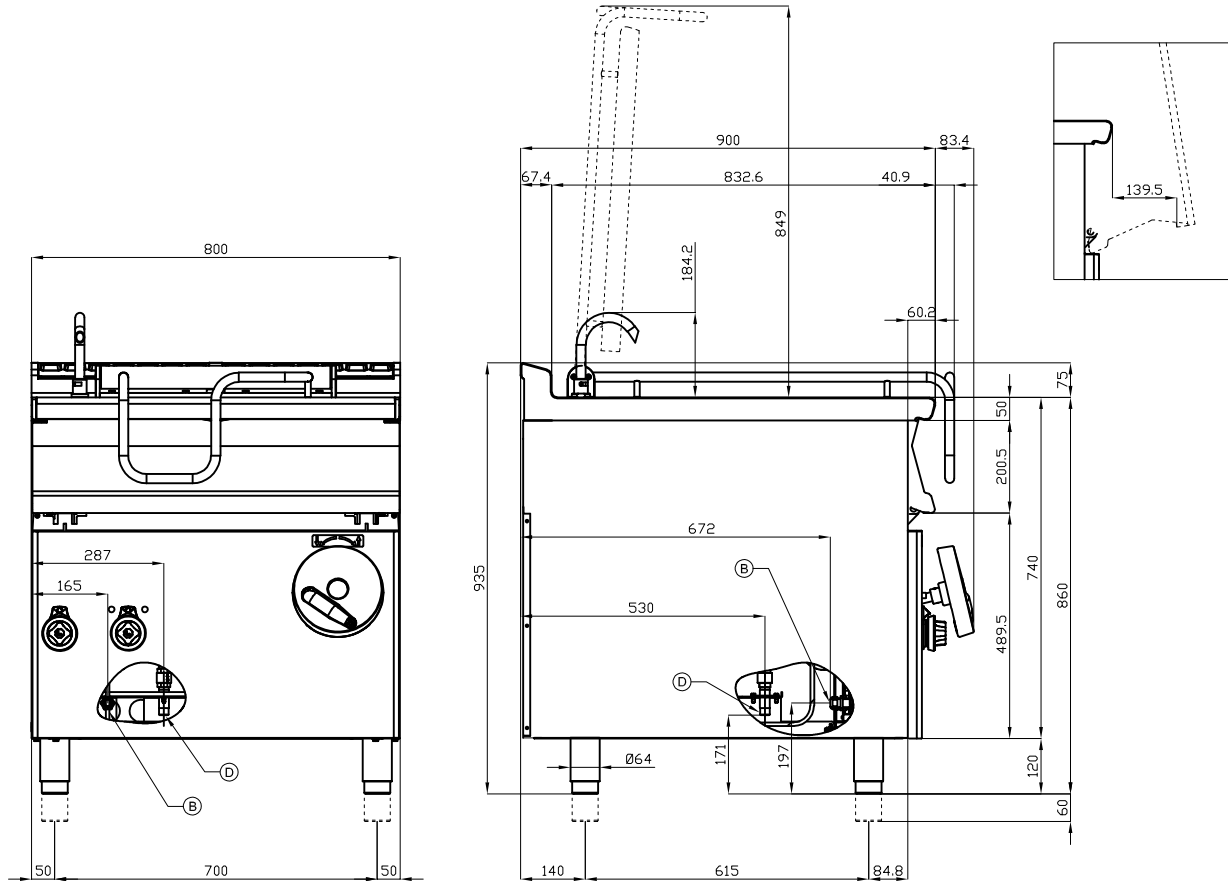

A	Data plate		B	Electrical connection	
D	Cold water connection	ISO 7-1 1/2" M			

MODEL: BR80-98ETF/I
 DIMENSIONS: cm. 80x 90x 90h
 ELECTRIC POWER: 12 kW
 VOLTAGE: 400V~3N
 FREQUENCY: 50/60 Hz



kg: 156
 m³: 0.894
 mm: 830x970x1110

BUY LOTUS BUY ITALY

The pictures are purely representative. The manufacturer reserves the right to modify the technical data and models without previous notice.



LOTUS S.P.A. Via Calmaor, 46
 31020 San Vendemiano(TV) - Italy
 Tel. + 39 0438 778020 / 778468
 Fax + 39 0438 778277
 www.lotuscookers.it - lotus@lotuscookers.it