

# M-612

## 60 MAGICLOTUS STAND

Open Stand 40/80

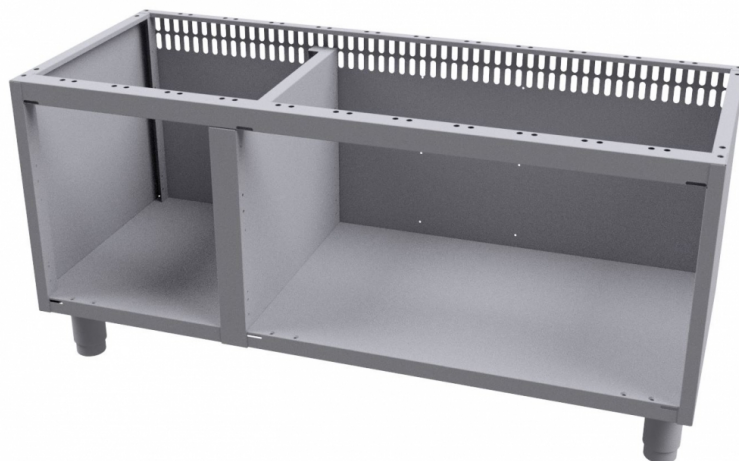

Construction - Fabricated using CrNi 18/10 AISI 304 grade Stainless Steel  
Scotch-Brite Satin polish Finish, rounded edges and chromed details.

Model - Professional Stand\*, also for Induction and Worktop Units.

Fittings - Appliance is supplied with adjustable feet, \*Doors not  
Included, except for Induction Unit top.



ITALIAN CULINARY ART

The pictures are purely representative. The manufacturer reserves the right to modify the technical data and models without previous notice.

# M-612

## 60 MAGICLOTUS STAND

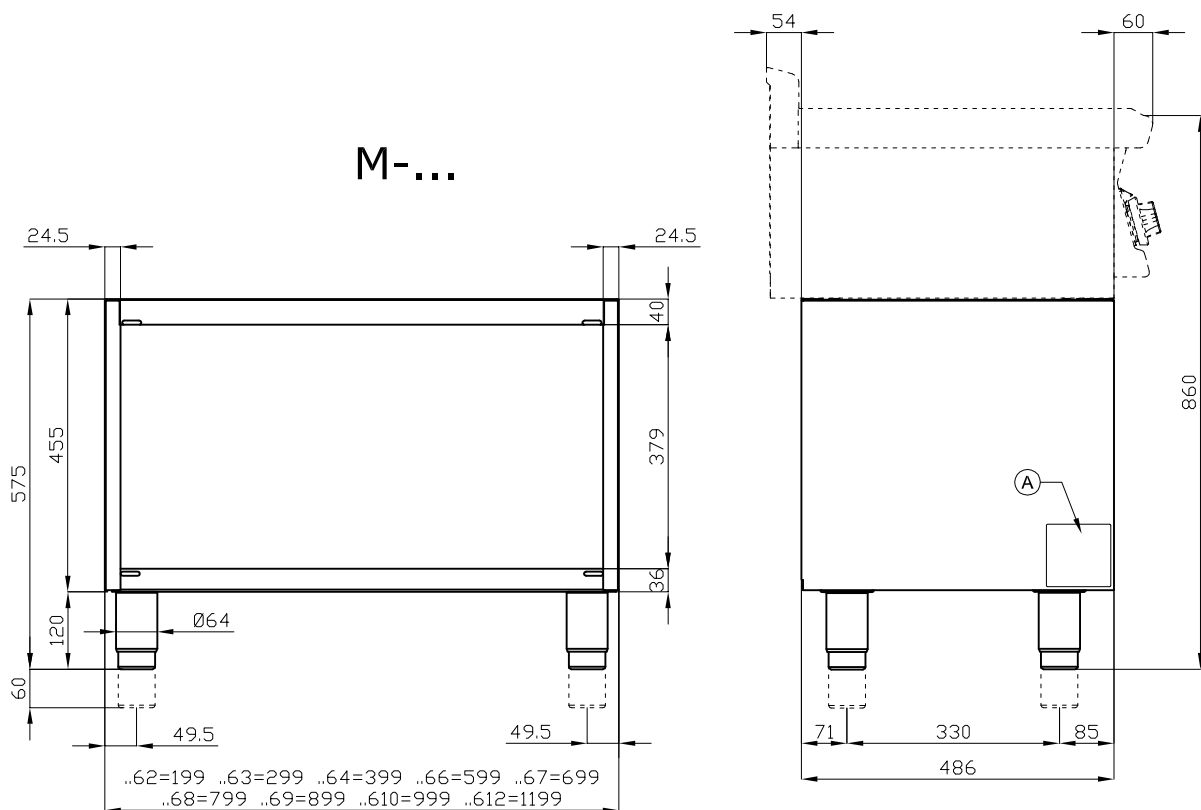

A	Data plate				
---	------------	--	--	--	--

MODEL:

M-612

DIMENSIONS:

cm. 120x 48,5x 57h



kg: 32  
m<sup>3</sup>: 0.552  
mm: 1230x690x650

BUY LOTUS BUY ITALY

The pictures are purely representative. The manufacturer reserves the right to modify the technical data and models without previous notice.



LOTUS S.P.A. Via Calmaor, 46  
31020 San Vendemiano (TV) - Italy  
Tel. + 39 0438 778020 / 778468  
Fax + 39 0438 778277  
www.lotuscookers.it - lotus@lotuscookers.it