

Datasheet

Chef'sCombi 6 GN Electric



Capacity:

- 6 2/1-GN pans
- Removable standard hinging rack with 83mm slide-in rail spacing.
- Selection of accessories for various procedures such as baking, braising, or grilling.

Modes:

- Convection: from 30 to 300°C
- Steam: from 30 to 100°C
- Hot Steam: from 101°C to 130°C
- Mixt: from 30 to 300°C

Description

All-in-one multifunctional cooking equipment: convection, steam cooking, roasting, grilling, baking, air frying, poaching, simmering, low temperature cooking, defrosting, regeneration, holding. Advanced cooking technologies for premium cooking results with powerful heating elements, lambda sensor-controlled climate regulation, high-performance dehumidification, controlled even heat distribution and humidifying function.

Chef'sCombi is equipped with the following technologies:

CombiOS

Operation, customizable, intuitive and responsive.

CombiClimateControl

Powerful climate management for outstanding cooking results.

Manual cooking with AutoClimate

Precise, quick and easy to use.

CombiGuide

For reproducible best cooking results, no matter who operates the Chef'sCombi.

MenuMix

Simple and fast mixed feeds.

CombiCare

Automatic cleaning. Clean, fast and inexpensive.

CombiOS

CombiOS is an innovative operating concept, based on smart phone operation, with a high-performance processor working in the background. This makes operation intuitive and very responsive. There are hardly any waiting times, especially when switching on or off. If desired, the user interface can be easily adapted to personal requirements.

CombiClimateControl

This is the basis for outstanding cooking performance. The heat is distributed evenly and, if required, powerfully in the cooking cabinet, ensuring the best cooking results even when fully loaded. Fresh steam is supplied by the steam generator. The high-performance dehumidification secures the desired crispiness.

AutoClimate

AutoClimate supports the user during manual cooking if required. AutoClimate sets the appropriate cooking climate depending on the cabinet temperature set.

CombiGuide

CombiGuide is the simple cooking assistant for reproducible cooking results, no matter who is at the helm. The user specifies how the food has to be cooked and CombiGuide automatically sets the ideal cooking climate. The load detection makes the appropriate adjustments. If necessary, the user can intervene at any time.

MenuMix

MenuMix monitors every level to the second. Simply load, set the timer and the Chef'sCombi will let you know when the food is ready. If desired, MenuMix can show which dishes go together. And of course, mixed loads can also be planned and saved accordingly. Everything is done to the point.

CombiCare

Automatic cleaning system with soiling detection and cleaning programs that can be ideally adapted to the degree of soiling. Usage of solid Cleaner-Tabs and easy to use Care-Sticks. After a short time, the cooking chamber, steam generator and drain are hygienically clean and free of limescale. Thanks to its special technology, the Chef'sCombi requires little energy, few chemicals and little time.

Description and functions

Operation

- Capacitive 10"-HD-Touchscreen usable with gloves.
- Easy smartphone-like operation such as dragging, swiping, widgets, tutorials etc.
- High performance processor for responsive operation.
- Simple customizing of the display content.
- User interface can be set in different languages.
- Creation of individual user profiles with optional PIN-codes.
- Different language setting for individual user profile.
- Easy-to-read screen content thanks to structured and large display of essential information.
- Loading and removal requests thanks to an energy-saving LED system, color display and illuminated control button.
- Device status displayed via illuminated control button visible from afar.
- Clear indications, such as preheating, loading, unloading and dynamic animations.
- Acoustic prompts and visual messages when user action is required.
- Extensive search function including all cooking paths, application examples and settings. Ability to apply filters and sort the search.
- Quick access to help and settings.
- Contextual help always shows current help content for the displayed screen content.
- Start the help file to check application example.
- Fast setting of desired temperature due to quick temperature selection menu.
- Fast adding of additional cooking time due to quick time selection menu.
- Top 12 favorites to ensure quick access to frequently used cooking methods.
- Time can be set to display in 12- or 24-hour format.
- Digital temperature display, can be set to °C or °F, displays target and actual values.
- Humidity and time of cooking cabinet are digitally displayed; displays target and actual values.
- Time setting is display in seconds, minutes, and hours.
- Sleep modes: offers a sleep mode and an intermediate sleep mode for extended cycles such as overnight cooking.

Automatic cooking functions

- Even energy distribution in the cooking cabinet by means of a controlled air distribution system with reversing fan wheel.
- Cooking protocols with automatic control and adaption of the cooking parameters to ensure optimum cooking result regardless of product size or load.
- Setting the desired cooking result by determining the browning level, degree of cooking and product size.
- Load detection and adaption of the cooking parameters to ensure reproducible cooking quality independent from load quantity.
- Monitoring of the browning level and calculation of the current browning level based on the Maillard reaction.
- Automatic adaption of the cooking climate depending on the cooking temperature set.
- Controlled multi-level cooking with timer for every level.
- Display of dishes that can be cooked together.
- Planning and storage of mixed loads to ensure a standardized production process.
- Core temperature positioning detection with user notification in case of incorrect positioning.
- Core temperature assistant for selecting the right core temperature depending on the food to be cooked.
- Automatic proofing of baked goods.
- Intuitive and individual programming of an unlimited number of cooking protocols with an unlimited number of drag-and-drop steps.
- Easily transfer cooking protocols to other cooking systems via secure cloud connection or via USB.
- Degraded mode will provide continuous convection cooking whatever the breakdown (except system electrical failure) like broken screen, broken button, etc., to be able to complete the service.
- Adaptive Speed Fan: Features 4 standard levels of fan speed, one maximum level, and automatically reduces the speed by half after 2 hours, while maintaining optimal performance.

Cooking functions

- 3 cooking modes: Hot air from 30 - 300°C, steam from 30 - 100°C, hot steam from 101-130°C, Combination of hot air and steam from 30 - 300°C.
- Maximum cooking temperature 300 °C.

- Powerful heating elements for short heat-up times and fast compensation of the temperature drop during full loads or à la carte operation.
- Highly effective steam generator to ensure maximum steam saturation with hygienic fresh steam even below 100°C.
- High power steam for special steam application such as dumplings.
- Humidifying function for outstanding baking results, fluffy crumb, and crispy, shiny crust.
- Percentage accurate humidity setting and control from 0-100%.
- Percentage-accurate measurement of the humidity below 100 °C for low temperature cooking.
- High performance dehumidification to ensure best possible evenness and high crispiness even with large food quantities.
- Degree-accurate control of cooking cabinet temperature.
- 5 adjustable air speeds.
- Safe and fast cooling of the cabinet by air or water with door closed.
- Core temperature probe with three measuring points.
- Optional external (USB) core temperature probe with six measuring points for soft or very small cooking products.
- Delta-T mode cooking mode.
- Automatically pre-selected start time with changeable date and time.

Cleaning & care

- Automatic cleaning and care system, independent of water pressure, for the cooking cabinet and steam generator.
- The circulation system allows the cleaning process, consisting of four efficient wash cycles and one rinse, to reduce resource consumption while ensuring optimal cleaning.
- Automatic cleaning and removal of limescale deposits within the steam generator during the cleaning cycle.
- Detection of the level of soiling based on the food cooked. Ideal adaption of the required cleaning process.
- Ultrafast rinsing in only 6 minutes for practically uninterrupted, hygienic production.
- Various cleaning programs for ideal adaptation to the degree of soiling.
- Usage of solid cleaning tablets and care sticks to ensure easy and safe operation.
- Advanced scale management includes regular boiler flushing and real-time detection of scale level, ensuring optimal unit operation.
- Inside and outside material: stainless steel DIN 1.4301 / ASTM 304, seamless hygienic cooking cabinet with rounded corners and optimized air flow.
- Glass and stainless-steel surfaces allow easy, safe external cleaning.
- IPX5-class protection against spraying water in all directions.

Occupational and operating safety

- Maximum level height not higher than 1.6 m when using a appropriate stand.
- Condensing/exhausting fume hood (accessory) capable of adjusting suction power and transmitting notifications service.
- Long-lasting & energy-efficient LEDs light in the cooking chamber, with excellent color fidelity.
- Euronorm certified.
- Double-glazed cooking chamber door with rear ventilation, special heat-reflective coating, and rotating panels for easy cleaning. Contact temperature of the cooking cabinet door max. 73°C.
- Integrated retractable hand shower and switchable spray/jet function.
- Electronic safety temperature limiter for steam generator and convection heating
- Integrated fan wheel brake.
- HACCP data storage and output via USB or via our “Hobart SmartConnect” app.
- Tested according to national and international standards for unsupervised operation.
- Maximum tray height must not exceed 1,60m when using a HOBART stand.
- Ergonomic door handle with right- / left-handed door opening and swing-shut function.
- Contamination detection with cleaning suggestion.

Networking

- Connectivity via Ethernet for a stable and secure connection. Ethernet interface.
- Wifi and Bluetooth available as an option via a USB Dongle (not supplied), providing wireless flexibility.
- Integrated USB interface for local data exchange.
- Free application that allows you to monitor your entire ITW hardware fleet via a single application, allowing convenient remote control and management.
- Free application that allows you to create, modify & upload your personal cooking protocols from home.

Installation, maintenance and environment

- Professional installation by HOBART-certified technicians recommended.
- Adaptation to the installation site (height above sea level) through calibration at installation.
- Operation without water softener and without additional manual descaling possible.
- Service diagnostic system with automatic service message display, self-test function for active testing of unit functions.
- Regular maintenance is recommended. Servicing by HOBART service partner according to manufacturer recommendations
- 1-year HOBART warranty including parts.
- Energy efficiency in accordance with ENERGY STAR tested and passed. Published at www.energystar.gov.
- Consumption Tracking: Monitors energy, cleaning products and water usage via the “Hobart SmartConnect” app.
- Simplified accessibility: Easier maintenance interventions thanks to the standardization of components place. Identical arrangement of components in all the ovens.
- Electronic control board is directly accessible to technicians, simplifying interventions and checks with positioning in maintenance mode.
- See the installation manual for details** Terms and conditions apply, see manufacturer warranty statement at www.hobart.de.

Options

- Voltage : Three-phase 230 Volts.
- Reverse door (hinges on the left).
- Grease collection.

Technical characteristics

CODE	
Article code	HICS62E
Technical code	HICS62E

DIMENSIONS (H x W x A)	
Exterior (total)	898 x 1042 x 1043 mm
Exterior (body)	754 x 1042 x 976 mm
Maximum working height*	1380 / 1558 mm
Minimum working height *	965 / 1143 mm
Oven height + base*	1589 / 1767 mm

* Depending on the height of the HOBART base used as an accessory

CAPACITIES	
Number of seats per day	200
GN 2/1 plates (650 x 530mm)	6
Max depth of bins	65 mm
Spacing between floors	83 mm
Maximum load per level	10 kg
Total maximum load	60 kg

WEIGHT (gross / net)	
	190 kg / 170 kg

PACKING	
Height x Width x Projection	1091 x 1090 x 1090 mm

MINIMUM DISTANCES / WALLS			
	LEFT	Back	RIGHT
Minimum deviation	50 mm	0 mm	50 mm
Standard	500 mm	0 mm	50 mm
Heat sources	350 mm	0 mm	50 mm

AIR EXHAUST AND THERMAL LOAD	
Latent thermal load	3942 W
Sensible heat emission	2628 W
Acoustic emission	< 70 dB (A)

CONSTRUCTION	
Muffle and Bodywork	Stainless Steel 18-10

DEVICE TYPE	
	Table top

CONNECTION SPECIFICS DATA	
LAN data interface	RJ45
WiFi data interface	IEEE 802.11 ac/a/b/g/n

ELECTRICITY	
Three phase 230V+E	
I. Max	57,2 A
Total power	21,9 kW
“Steam” power	17,5 kW
“Pulsed air” power	21,6 kW
Necessary protection	63A curve C or B circuit breaker & 30mA type AC or A differential circuit breaker
Three phase 400V+E+N	
I. Max	34,2 A
Total power	21,9 kW
“Steam” power	17,5 kW
“Pulsed air” power	21,6 kW
Necessary protection	35A curve C or B circuit breaker & 30mA type AC or A differential circuit breaker
Three phase 400V+E	
I. Max	34,2 A
Total power	21,9 kW
“Steam” power	17,5 kW
“Pulsed air” power	21,6 kW
Necessary protection	35A curve C or B circuit breaker & 30mA type AC or A differential circuit breaker

COLD FOOD WATER	
Pressure (Min / Max)	150/600 kPa (1.5 bar / 6 bar)
Max cold water temperature	23°C
Nature	Filtered at 131 µm
Water quality	Chloride Cl ⁻ : ≤ 150 mg/l (150ppm) Free Chlorine Cl ₂ : ≤ 0.2 mg/l (0.2ppm) 6.5 ≤ PH ≤ 9
Conductivity	≥ 50 µS/cm
Connection	20/27 thread
Max. instantaneous consumption	12.7 l/min

Provide a shut-off valve nearby.

SOFT WATER	
Pressure (Min / Max)	150/600 kPa (1.5 bar / 6 bar)
Max softened water temperature	23°C
Nature	Filtered at 131 µm
Hardness	TH 4 to 14°e (60 to 200 ppm)
Water quality	Chloride Cl ⁻ : ≤ 150 mg/l (150ppm) Free Chlorine Cl ₂ : ≤ 0.2 mg/l (0.2ppm) 6.5 ≤ PH ≤ 9
Conductivity	≥ 50 µS/cm
Connection	20/27 thread
Max. instantaneous consumption	7.7 l/min

Provide a shut-off valve nearby.

DRAIN	
Connection	Horizontal outlet Smooth tube Ø 40mm

The water discharged can be condensates at high temperatures, use materials adapted to these temperatures. It is imperative to have a siphon between the device and the drain network to prevent odors from rising.

Installation conditions

National and local standards and regulations relating to the installation, use and operation of industrial cooking appliances must be respected. Local standards and provisions in force relating to premises ventilation systems must be respected. Refer to the installation and user manual available on our Prospek Site.

> To use the “SMARTCONNECT365” app, you must provide an RJ45 network socket or the possibility of connecting to a WiFi network (IEEE 802.11 ac/a/b/g/n) at the installation location. For optimal performance, provide a data transmission rate of at least 100 MBit/s.

STANDARDS: Compliance with standards

EN 60335-1: European standards relating to the safety of electrical appliances.

EN 60335-2-42: European standards relating to the safety of electrical appliances.

IP 25 and IK 9: Protection indexes.





EN 1672-2: Hygiene.

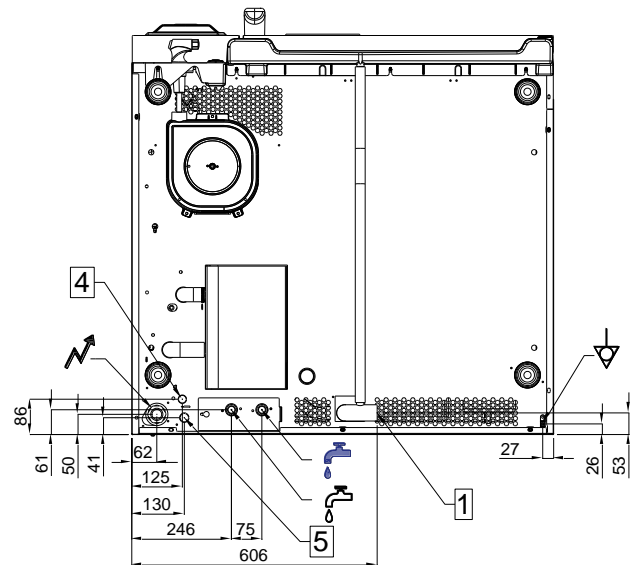
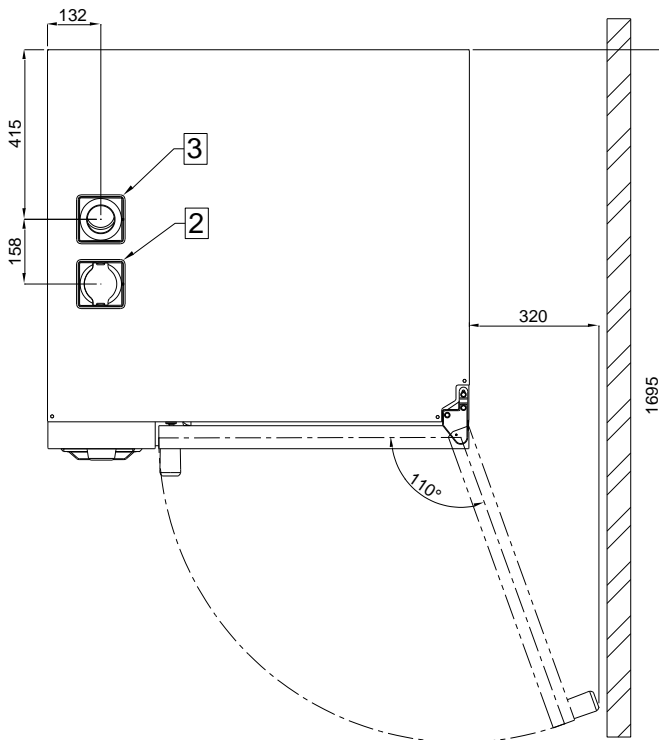
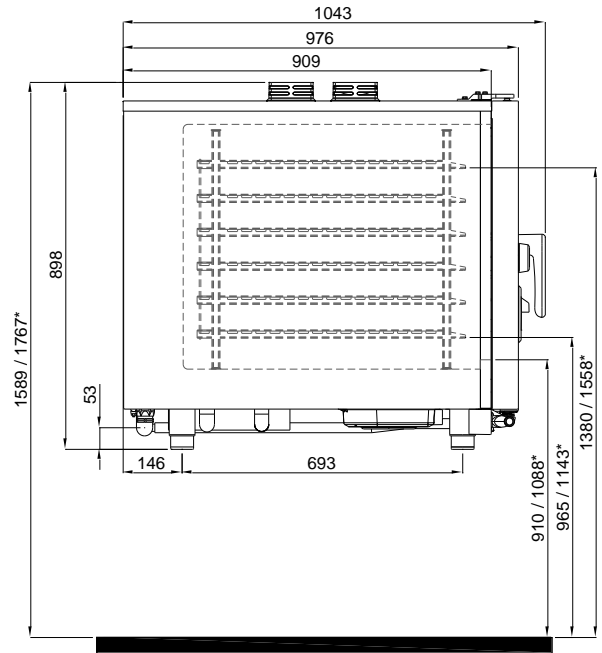
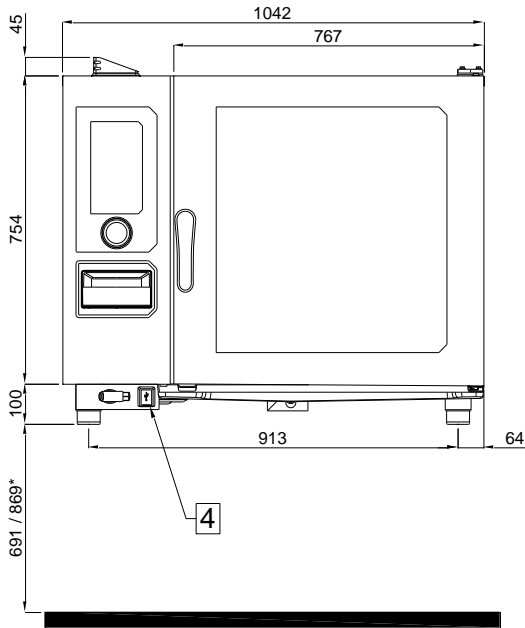

Technical drawing



* Depending on the height of the HOBART base used as an accessory

-  **ELECTRICAL connection**
Electric inlet at 260 mm from the support / 950-1129* from the floor
(Allow a cable with 1.5m of slack)
-  **COLD WATER food**
Water inlet at 80 mm from the support / 771-949* from the floor
-  **SOFT WATER**
Water inlet at 80 mm from the support / 771-949* from the floor
-  **ÉQUIPOTENTIAL BONDING**

- ① **DRAIN**
Drain outlet at 53 mm from the support / 744-922* from the floor
- ② **FLAPPER FIREPLACE**
Stainless steel tube diameter 70 mm
- ③ **EVACUATION OF EXCESS VAPORS**
Stainless steel tube diameter 70 mm
- ④ **ETHERNET PORT**
- ⑤ **ENERGY SAVING OPTION**

Accessories (see specific technical sheet)

- Kit 3 Grids
- Kit 5 Grids
- Steam Deflector Kit
- Stainless Steel Plinth kit for Stacked ovens
- Stainless Steel Plinth kit for ovens on Table
- Stacking Kit for Electric ovens
- Stacking Kit for Gas ovens
- Mobile Stand for Stacked ovens
- Mobile Stand for Stacked ovens (Safe Use 1.6m)
- Stand H.150 for Stacked ovens
- Stand H.250 for Stacked ovens
- Banqueting Running Device
- Condensing Hood (Elec)
- Cooking Grease Collection Kit
- Carbon Filter Kit for Condensation Hood
- HEPA Filter Kit for Condensation Hood
- Stand Mobile Kit
- Stand Cooking Grease Collection
- Anti-slip Extension Kit 26mm high
- Safety Door Latch Kit
- Levels Installation Kit
- Runners Kit 6 Lev. (Safe Use 1.6m)
- Runners Trolley sp.73
- Banqueting isothermic Jacket
- Stand Door Kit
- Stand
- Banqueting Trolley Table
- 10 litre container
- 20 litre container
- Cooking Grease Collection Trolley
- Floor Anchoring Kit for Stands
- Diam 200mm Connexion Hose Kit for Condensation Hood
- Energy Management Connex. Kit
- WIFI connectivity kit
- USB Core Probe Delicate Products 1pt d2.5x100mm
- USB Core Probe Standard 3pts d3,2x100mm
- Smoker
- Care-Stick (Bucket 100 sticks)
- Cleaner-Tab (Bucket 100 tabs)

We offer a wide range of cooking accessories to help you achieve perfect cooking results, for more information, please consult our accessories brochure or ask your dealer.

Agencies

HOBART GmbH
Robert Bosch Str. 17,
77656 Offenburg - GERMANY
Telefon: +49 781 6000
Fax: +49 781 600-231