



Goldstein

800 SERIES RANGES 1005mm GAS STATIC OVEN

PF840-X, PF12G640-X, PF24G440-X,
PF36G240-X, PF48G40-X,
PF12Q640-X, PF24Q440-X, PF36Q240-X,
PF48Q40-X



Standard features and benefits

- Heavy duty welded stainless steel body for rigidity and durability
- Fully welded surrounds for griddle and chargrill option
- The flexible modular cooktop design allows for various combinations of burners, griddle plates, and chargrill options (305, 610, 914, 1219mm)
- Gas or electric static oven, fan forced oven and convection oven options are available, all in gastronorm compatible sizes
- Constant pilot flame, maximises operating and energy efficiency
- Pilot flame failure on open burners, flame failure to oven burner
- Stainless steel fascia and sides, spill zone and drip trays for ease of cleaning
- Large, heat resistant reinforced control knob with easy to view settings and high to low flame control
- Ergonomic door handle and angled corners create a sleek look
- Griddle and BBQ section are on left hand side
- Adjustable legs 140-170mm
- Easy to service



Burners

- Removable, high performance, even heat 33 MJ cooktop burners for peak productivity
- 40% of the flame ports are in the centre cross of the burner
- Cast iron star trivets

Griddle plate

- 20mm thick mild steel griddle plate
- 20 MJ griddle burners per every 305mm section
- Piezo ignition

Chargrill

- Heavy duty cast iron reversible grates provide greater control when cooking, energy efficiency, and offer two char pattern options
- 2 levelling options - flat or gradient
- 2x 20 MJ inline cast iron burners per every 305mm section
- Ceramic rocks option available to increase heat retention and flavour

Oven

- 100°C - 280°C thermostatic control
- Piezo ignition
- Oven and door are fully insulated with vitreous enamel for even heat distribution and easy cleaning
- GN 1/1 capacity with 3 position racking
- Heavy duty chrome wire rack supports designed for easy removal

Oven Options

- Gas static and fan forced oven
- Electric static, fan forced and convection oven



Cert. No.
AGA 7732



1800 013 123 | +61 2 9604 7333
sales@middleby.com.au
middleby.com.au

VIC - TAS - 47 Stubbs Street, Kensington VIC 3031
QLD - U12, 210 Queensport Rd Nth, Murarrie QLD 4172
WA - U2, 9 Meares Way, Canning Vale WA 6155

HEAD OFFICE
AND MANUFACTURING PLANT
211-217 Woodpark Road, Smithfield NSW 2164

v1_2024



PF840-X, PF12G640-X, PF24G440-X, PF36G240-X, PF48G40-X,
PF12Q640-X, PF24Q440-X, PF36Q240-X, PF48Q40-X

800 SERIES RANGES 1005mm GAS STATIC OVEN

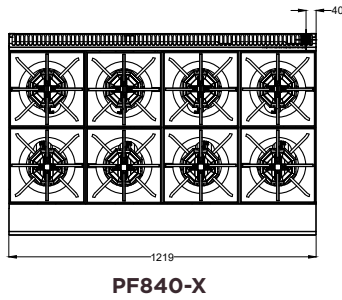

PF840-X

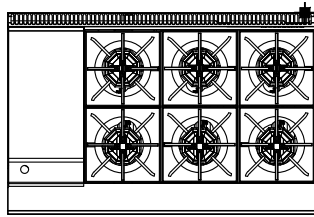
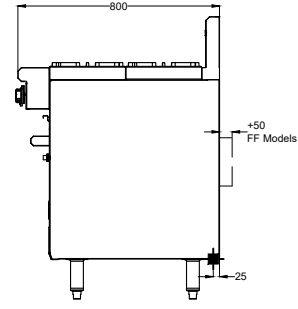
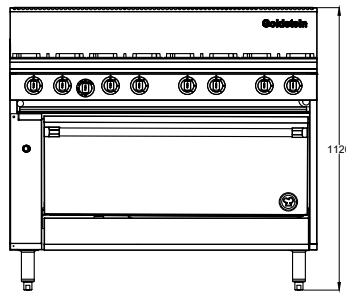

PF12G640-X

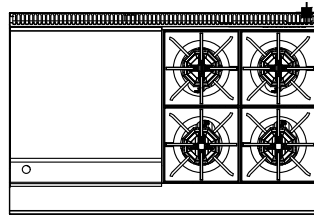

PF24G440-X

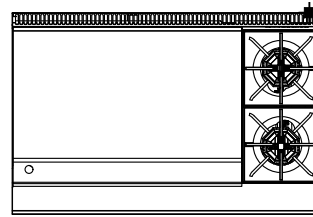

PF36G240-X

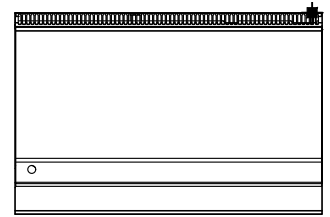

PF48G40-X

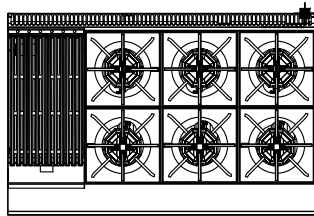

PF12Q640-X

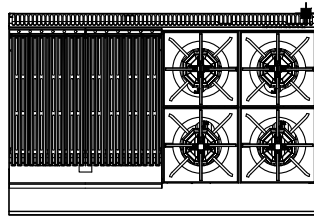

PF24Q440-X

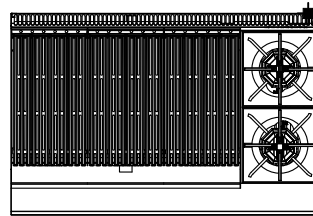

PF36Q240-X

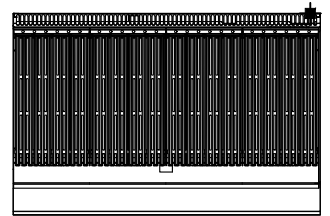

PF48Q40-X

SPECIFICATIONS

Dimensions (WxDxH)	1219 x 800 x 1120 mm
Working height	914 mm
Oven size (WxDxH)	1005 x 560 x 355 mm
Oven Rack Positions	3
Griddle size	PF12G640-X 305 x 520 x 20 mm
	PF12G440-X 610 x 520 x 20 mm
	PF24G240-X 914 x 520 x 20 mm
	PF36G40-X 1219 x 520 x 20 mm
Grill size	PF12Q640-X 305 x 510 mm
	PF12Q440-X 610 x 510 mm
	PF24Q240-X 914 x 510 mm
	PF36Q40-X 1219 x 510 mm

Gas connection	3/4" BSPM
PF840-X	299/300 MJ
PF12G640-X	253/254 MJ
PF12G440-X	207/208 MJ
PF24G240-X	161/162 MJ
Rating NG/LPG	PF36G40-X 115/116 MJ
	PF12Q640-X 273/272 MJ
	PF12Q440-X 247/244 MJ
	PF24Q240-X 221/216 MJ
	PF36Q40-X 195/188 MJ
Packed dimensions	1280 x 900 x 1200

Available in Natural and LP gas

INSTALLATION CLEARANCES (minimum)

Combustible Material	Sides	250* mm	Non-combustible Material	Sides	0 mm
	Back	50 mm		Back	0 mm

Note: * If adjacent surface is of combustible material and is 100mm below the cooking surface, then only 50mm clearance is required.

Please note, due to ongoing product development and improvement, we reserve the right to change product design and specification at any time without notice.



1800 013 123 | +61 2 9604 7333
sales@middleby.com.au
middleby.com.au

VIC - TAS - 47 Stubbs Street, Kensington VIC 3031
QLD - U12, 210 Queensport Rd Nth, Murarrie QLD 4172
WA - U2, 9 Meares Way, Canning Vale WA 6155

HEAD OFFICE AND MANUFACTURING PLANT
211-217 Woodpark Road, Smithfield NSW 2164

v1_2024



800 SERIES RANGES 1005mm OVEN OPTIONS

Model Number	Dimensions (mm) WxDxH	Oven size (mm) WxDxH	Rating (MJ) NG/LPG	Rating (kW)
--------------	--------------------------	-------------------------	-----------------------	----------------

8 burners

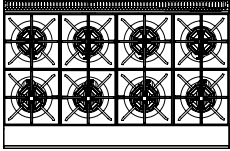

PF840FF-X Gas Fan Forced Oven	1219 x 850 x 1120	1005 x 525 x 355	299/300	
PF840EFF-X Electric Fan Forced Oven	1219 x 850 x 1120	1005 x 525 x 305	264/264	8.8
PFC840E-X Electric Convection Oven	1219 x 900 x 1120	990 x 410 x 320	299/300	10
PF840E-X Electric Static Oven	1219 x 800 x 1120	1005 x 560 x 305	264/264	8.8

6 burners, 305mm griddle plate

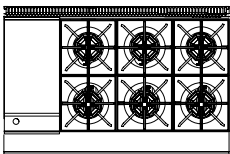

PF12G640FF-X Gas Fan Forced Oven	1219 x 850 x 1120	1005 x 525 x 355	253/254	
PF12G640EFF-X Electric Fan Forced Oven	1219 x 850 x 1120	1005 x 525 x 305	218/218	8.8
PFC12G640E-X Electric Convection Oven	1219 x 900 x 1120	990 x 410 x 320	253/254	10
PF12G640E-X Electric Static Oven	1219 x 800 x 1120	1005 x 560 x 305	218/218	8.8

4 burners, 610mm griddle plate

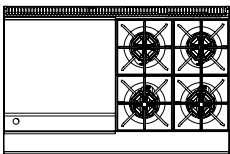

PF24G440FF-X Gas Fan Forced Oven	1219 x 850 x 1120	1005 x 525 x 355	207/208	
PF24G440EFF-X Electric Fan Forced Oven	1219 x 850 x 1120	1005 x 525 x 305	172/172	8.8
PFC24G440E-X Electric Convection Oven	1219 x 900 x 1120	990 x 410 x 320	207/208	10
PF24G440E-X Electric Static Oven	1219 x 800 x 1120	1005 x 560 x 305	172/172	8.8

2 burners, 914mm griddle plate

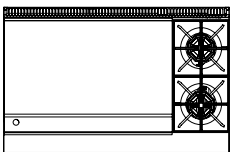

PF36G240FF-X Gas Fan Forced Oven	1219 x 850 x 1120	1005 x 525 x 355	161/162	
PF36G240EFF-X Electric Fan Forced Oven	1219 x 850 x 1120	1005 x 525 x 305	126/126	8.8
PFC36G240E-X Electric Convection Oven	1219 x 900 x 1120	990 x 410 x 320	161/162	10
PF36G240E-X Electric Static Oven	1219 x 800 x 1120	1005 x 560 x 305	126/126	8.8

1219mm griddle plate

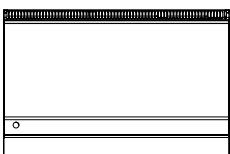

PF48G40FF-X Gas Fan Forced Oven	1220 x 850 x 1120	1005 x 525 x 355	115/116	
PF48G40EFF-X Electric Fan Forced Oven	1219 x 850 x 1120	1005 x 525 x 305	80/80	8.8
PFC48G40E-X Electric Convection Oven	1219 x 900 x 1120	990 x 410 x 320	118/119	10
PF48G40E-X Electric Static Oven	1219 x 800 x 1120	1005 x 560 x 305	80/80	8.8

Please note, due to ongoing product development and improvement, we reserve the right to change product design and specification at any time without notice.

MIDDLEBY GOLDSTEIN

1800 013 123 | +61 2 9604 7333
sales@middleby.com.au
middleby.com.au

VIC - TAS - 47 Stubbs Street, Kensington VIC 3031
QLD - U12, 210 Queensport Rd Nth, Murarrie QLD 4172
WA - U2, 9 Meares Way, Canning Vale WA 6155

**HEAD OFFICE
AND MANUFACTURING PLANT**
211-217 Woodpark Road, Smithfield NSW 2164

v1_2024



800 SERIES RANGES 1005mm OVEN OPTIONS

Model Number	Dimensions (mm) WxDxH	Oven size (mm) WxDxH	Rating (MJ) NG/LPG	Rating (kW)
--------------	--------------------------	-------------------------	-----------------------	----------------

6 burners, 305mm chargrill

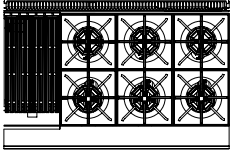

PF12Q640FF-X Gas Fan Forced Oven	1219 x 850 x 1120	1005 x 525 x 355	273/272	
PF12Q640EFF-X Electric Fan Forced Oven	1219 x 850 x 1120	1005 x 525 x 305	238/236	8.8
PFC12Q640E-X Electric Convection Oven	1219 x 900 x 1120	990 x 410 x 320	273/272	10
PF12Q640E-X Electric Static Oven	1219 x 800 x 1120	1005 x 560 x 305	238/236	8.8

4 burners, 610mm chargrill

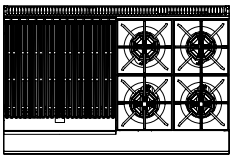

PF24Q440FF-X Gas Fan Forced Oven	1219 x 850 x 1120	1005 x 525 x 355	247/244	
PF24Q440EFF-X Electric Fan Forced Oven	1220 x 850 x 1120	1005 x 525 x 305	212/208	8.8
PFC24Q440E-X Electric Convection Oven	1220 x 900 x 1120	990 x 410 x 320	247/244	10
PF24Q440E-X Electric Static Oven	1220 x 800 x 1120	1005 x 560 x 305	212/208	8.8

2 burners, 914mm chargrill

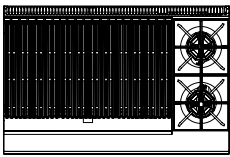

PF36Q240FF-X Gas Fan Forced Oven	1219 x 850 x 1120	1005 x 525 x 355	221/216	
PF36Q240EFF-X Electric Fan Forced Oven	1219 x 850 x 1120	1005 x 525 x 305	186/180	8.8
PFC36Q240E-X Electric Convection Oven	1219 x 900 x 1120	990 x 410 x 320	221/216	10
PF36Q240E-X Electric Static Oven	1219 x 800 x 1120	1005 x 560 x 305	186/180	8.8

1219mm chargrill

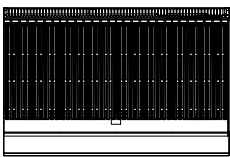

PF48Q40FF-X Gas Fan Forced Oven	1219 x 850 x 1120	1005 x 525 x 355	195/188	
PF48Q40EFF-X Electric Fan Forced Oven	1219 x 850 x 1120	1005 x 525 x 305	160/152	8.8
PFC48Q40E-X Electric Convection Oven	1219 x 900 x 1120	990 x 410 x 320	195/188	10
PF48Q40E-X Electric Static Oven	1219 x 800 x 1120	1005 x 560 x 305	160/152	8.8

Please note, due to ongoing product development and improvement, we reserve the right to change product design and specification at any time without notice.



1800 013 123 | +61 2 9604 7333
sales@middleby.com.au
middleby.com.au

VIC - TAS - 47 Stubbs Street, Kensington VIC 3031
QLD - U12, 210 Queensport Rd Nth, Murarrie QLD 4172
WA - U2, 9 Meares Way, Canning Vale WA 6155

HEAD OFFICE
AND MANUFACTURING PLANT
211-217 Woodpark Road, Smithfield NSW 2164

v1_2024