



Goldstein

800 SERIES RANGES 700mm GAS STATIC OVEN

PF628-X, PF12G428-X, PF24G228-X, PF36G28-X
PF12Q428-X, PF24Q228-X, PF36Q28-X

**INDUSTRY
KITCHENS**
www.industrykitchens.com.au 1800 611 058



Standard features and benefits

- Heavy duty welded stainless steel body for rigidity and durability
- Fully welded surrounds for griddle and chargrill option
- The flexible modular cooktop design allows for various combinations of burners, griddle plates, and chargrill options (305, 610, 914mm)
- Gas or electric static oven, fan forced oven and convection oven options are available, all in gastronom compatible sizes
- Constant pilot flame, maximises operating and energy efficiency
- Pilot flame failure on open burners, flame failure to oven burner
- Stainless steel fascia and sides, spill zone and drip trays for ease of cleaning
- Large, heat resistant reinforced control knob with easy to view settings and high to low flame control
- Ergonomic door handle and angled corners create a sleek look
- Griddle and BBQ section are on left hand side
- Adjustable legs 140-170mm
- Easy to service

Burners

- Removable, high performance, even heat 33 MJ cooktop burners for peak productivity
- 40% of the flame ports are in the centre cross of the burner
- Cast iron star trivets

Griddle plate

- 20mm thick mild steel griddle plate
- 20 MJ griddle burners per every 305mm section
- Piezo ignition

Chargrill

- Heavy duty cast iron reversible grates provide greater control when cooking, energy efficiency, and offer two char pattern options
- 2 levelling options - flat or gradient
- 2x 20 MJ inline radiant burners per every 305mm section
- Ceramic rocks option available to increase heat retention and flavour

Oven

- 100°C - 280°C thermostatic control
- Piezo ignition
- Oven and door are fully insulated with vitreous enamel for even heat distribution and easy cleaning
- GN 1/1 capacity with 3 position racking
- Heavy duty chrome wire rack supports designed for easy removal

Oven Options

- Gas static, fan forced and convection oven
- Electric static, fan forced and convection oven



Cert. No.
AGA 7732

MIDDLEBY GOLDSTEIN

1800 013 123 | +61 2 9604 7333
sales@middleby.com.au
middleby.com.au

VIC - TAS - 47 Stubbs Street, Kensington VIC 3031
QLD - U12, 210 Queensport Rd Nth, Murarrie QLD 4172
WA - U2, 9 Meares Way, Canning Vale WA 6155

**HEAD OFFICE
AND MANUFACTURING PLANT**
211-217 Woodpark Road, Smithfield NSW 2164

v1_2024



PF628-X, PF12G428-X, PF24G228-X, PF36G28-X, PF12Q428-X, PF24Q228-X, PF36Q28-X 800 SERIES RANGES 700mm GAS STATIC OVEN

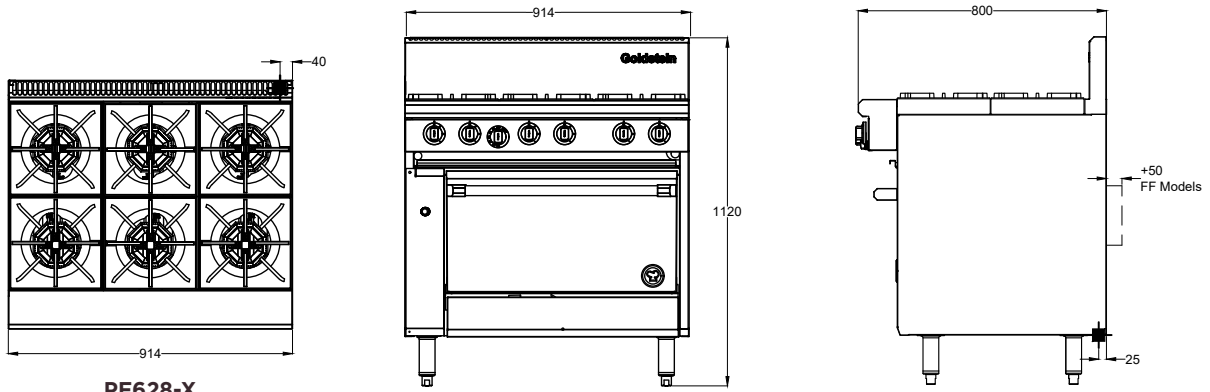

PF628-X

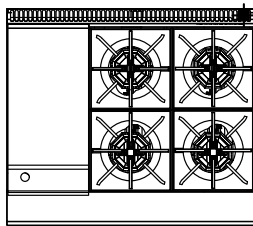

PF12G428-X

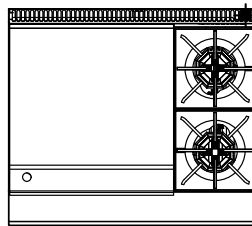

PF24G228-X

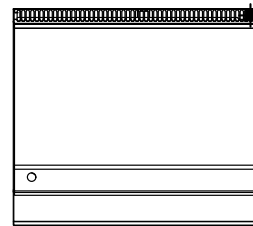

PF36G28-X

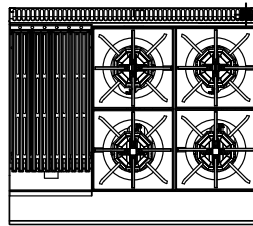

PF12Q428-X

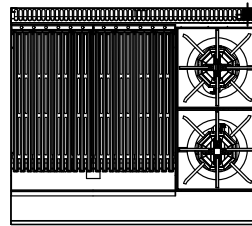

PF24Q228-X

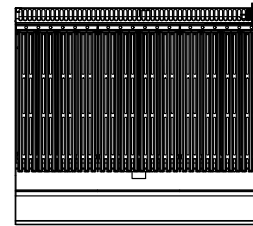

PF36Q28-X

SPECIFICATIONS

Dimensions (WxDxH)	914 x 800 x 1120 mm	
Working height	914 mm	
Oven size (WxDxH)	700 x 560 x 355 mm	
Oven Rack Positions	3	
Griddle size	PF12G428-X	305 x 520 x 20 mm
	PF24G228-X	610 x 520 x 20 mm
	PF36G28-X	914 x 520 x 20 mm
Grill size	PF12Q428-X	305 x 510 mm
	PF24Q228-X	610 x 510 mm
	PF36Q28-X	914 x 510 mm

Gas connection	3/4" BSPM	
Rating NG/LPG	PF628-X	226/228 MJ
	PF12G428-X	180/182 MJ
	PF24G228-X	134/136 MJ
Packed dimensions	PF36G28-X	88/90 MJ
	PF12Q428-X	200/200 MJ
	PF24Q228-X	174/172 MJ
PF36Q28-X	148/144 MJ	
Packed dimensions	980 x 900 x 1200 mm	

Available in Natural and LP gas

INSTALLATION CLEARANCES (minimum)

Combustible Material	Sides	250* mm	Non-combustible Material	Sides	0 mm
	Back	50 mm		Back	0 mm

Note: * If adjacent surface is of combustible material and is 100mm below the cooking surface, then only 50mm clearance is required.

Please note, due to ongoing product development and improvement, we reserve the right to change product design and specification at any time without notice.



1800 013 123 | +61 2 9604 7333
sales@middleby.com.au
middleby.com.au

VIC - TAS - 47 Stubbs Street, Kensington VIC 3031
QLD - U12, 210 Queensport Rd Nth, Murarrie QLD 4172
WA - U2, 9 Meares Way, Canning Vale WA 6155

HEAD OFFICE AND MANUFACTURING PLANT
211-217 Woodpark Road, Smithfield NSW 2164

v1_2024



800 SERIES RANGES 700mm OVEN OPTIONS

Model Number	Dimensions (mm) WxDxH	Oven size (mm) WxDxH	Rating (MJ) NG/LPG	Rating (kW)
--------------	--------------------------	-------------------------	-----------------------	----------------

6 burners

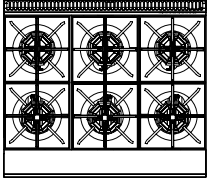

PF628FF-X Gas Fan Forced Oven	914 x 850 x 1120	700 x 525 x 355	226/228	
PF628EFF-X Electric Fan Forced Oven	914 x 850 x 1120	700 x 525 x 305	198/198	6.4
PFC628-X Gas Convection Oven	914 x 900 x 1120	690 x 410 x 320	226/228	10
PFC628E-X Electric Convection Oven	914 x 900 x 1120	690 x 410 x 320	198/198	10
PF628E-X Electric Static Oven	914 x 800 x 1120	700 x 560 x 305	198/198	6.4

4 burners, 305mm griddle plate

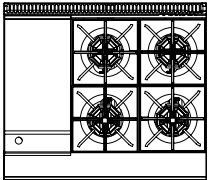

PF12G428FF-X Gas Fan Forced Oven	914 x 850 x 1120	700 x 525 x 355	180/182	
PF12G428EFF-X Electric Fan Forced Oven	914 x 850 x 1120	700 x 525 x 305	152/152	6.4
PFC12G428-X Gas Convection Oven	914 x 900 x 1120	690 x 410 x 320	180/182	10
PFC12G428E-X Electric Convection Oven	914 x 900 x 1120	690 x 410 x 320	152/152	10
PF12G428E-X Electric Static Oven	914 x 800 x 1120	700 x 560 x 305	152/152	6.4

2 burners, 610mm griddle plate

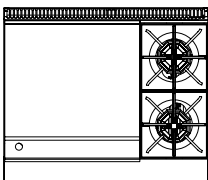

PF24G228FF-X Gas Fan Forced Oven	914 x 850 x 1120	700 x 525 x 355	134/136	
PF24G228EFF-X Electric Fan Forced Oven	914 x 850 x 1120	700 x 525 x 305	106/106	6.4
PFC24G228-X Gas Convection Oven	914 x 900 x 1120	690 x 410 x 320	134/136	10
PFC24G228E-X Electric Convection Oven	914 x 900 x 1120	690 x 410 x 320	106/106	10
PF24G228E-X Electric Static Oven	914 x 800 x 1120	700 x 560 x 305	106/106	6.4

914mm griddle plate

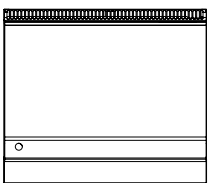

PF36G28FF-X Gas Fan Forced Oven	914 x 850 x 1120	700 x 525 x 355	88/90	
PF36G28EFF-X Electric Fan Forced Oven	914 x 850 x 1120	700 x 525 x 305	60/60	6.4
PFC36G28-X Gas Convection Oven	914 x 900 x 1120	690 x 410 x 320	88/90	10
PFC36G28E-X Electric Convection Oven	914 x 900 x 1120	690 x 410 x 320	60/60	10
PF36G28E-X Electric Static Oven	914 x 800 x 1120	700 x 560 x 305	60/60	6.4

Please note, due to ongoing product development and improvement, we reserve the right to change product design and specification at any time without notice.



1800 013 123 | +61 2 9604 7333
sales@middleby.com.au
middleby.com.au

VIC - TAS - 47 Stubbs Street, Kensington VIC 3031
QLD - U12, 210 Queensport Rd Nth, Murarrie QLD 4172
WA - U2, 9 Meares Way, Canning Vale WA 6155

HEAD OFFICE
AND MANUFACTURING PLANT
211-217 Woodpark Road, Smithfield NSW 2164

v1_2024



800 SERIES RANGES 700mm OVEN OPTIONS

Model Number	Dimensions (mm) WxDxH	Oven size (mm) WxDxH	Rating (MJ) NG/LPG	Rating (kW)
--------------	--------------------------	-------------------------	-----------------------	----------------

4 burners, 305mm chargrill

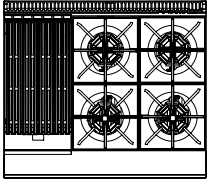

PF12Q428FF-X Gas Fan Forced Oven	914 x 850 x 1120	700 x 525 x 355	200/200	
PF12Q428EFF-X Electric Fan Forced Oven	914 x 850 x 1120	700 x 525 x 305	172/170	6.4
PFC12Q428-X Gas Convection Oven	914 x 900 x 1120	690 x 410 x 320	200/200	10
PFC12Q428E-X Electric Convection Oven	914 x 900 x 1120	690 x 410 x 320	172/170	10
PF12Q428E-X Electric Static Oven	914 x 800 x 1120	700 x 560 x 305	172/170	6.4

2 burners, 610mm chargrill

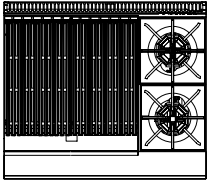

PF24Q228FF-X Gas Fan Forced Oven	914 x 850 x 1120	700 x 525 x 355	174/172	
PF24Q228EFF-X Electric Fan Forced Oven	914 x 850 x 1120	700 x 525 x 305	146/142	6.4
PFC24Q228-X Gas Convection Oven	914 x 900 x 1120	690 x 410 x 320	174/172	10
PFC24Q228E-X Electric Convection Oven	914 x 900 x 1120	690 x 410 x 320	146/142	10
PF24Q228E-X Electric Static Oven	914 x 800 x 1120	700 x 560 x 305	146/142	6.4

914mm char grill

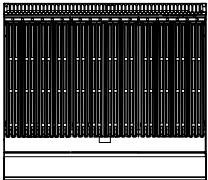

PF36Q28FF-X Gas Fan Forced Oven	914 x 850 x 1120	700 x 525 x 355	148/144	
PF36Q28EFF-X Electric Fan Forced Oven	914 x 850 x 1120	700 x 525 x 305	120/114	6.4
PFC36Q28-X Gas Convection Oven	914 x 900 x 1120	690 x 410 x 320	148/144	10
PFC36Q28E-X Electric Convection Oven	914 x 900 x 1120	690 x 410 x 320	120/114	10
PF36Q28E-X Electric Static Oven	914 x 800 x 1120	700 x 560 x 305	120/114	6.4

Please note, due to ongoing product development and improvement, we reserve the right to change product design and specification at any time without notice.



1800 013 123 | +61 2 9604 7333
sales@middleby.com.au
middleby.com.au

VIC - TAS - 47 Stubbs Street, Kensington VIC 3031
QLD - U12, 210 Queensport Rd Nth, Murarrie QLD 4172
WA - U2, 9 Meares Way, Canning Vale WA 6155

HEAD OFFICE
AND MANUFACTURING PLANT
211-217 Woodpark Road, Smithfield NSW 2164

v1_2024