



**Goldstein**

# 800 SERIES RANGES 700mm GAS STATIC OVEN

PF628-X, PF12G428-X, PF24G228-X, PF36G28-X  
PF12Q428-X, PF24Q228-X, PF36Q28-X

**INDUSTRY  
KITCHENS**  
www.industrykitchens.com.au 1800 611 058



## Standard features and benefits

- Heavy duty welded stainless steel body for rigidity and durability
- Fully welded surrounds for griddle and chargrill option
- The flexible modular cooktop design allows for various combinations of burners, griddle plates, and chargrill options (305, 610, 914mm)
- Gas or electric static oven, fan forced oven and convection oven options are available, all in gastronorm compatible sizes
- Constant pilot flame, maximises operating and energy efficiency
- Pilot flame failure on open burners, flame failure to oven burner
- Stainless steel fascia and sides, spill zone and drip trays for ease of cleaning
- Large, heat resistant reinforced control knob with easy to view settings and high to low flame control
- Ergonomic door handle and angled corners create a sleek look
- Griddle and BBQ section are on left hand side
- Adjustable legs 140-170mm
- Easy to service

### Burners

- Removable, high performance, even heat 33 MJ cooktop burners for peak productivity
- 40% of the flame ports are in the centre cross of the burner
- Cast iron star trivets

### Griddle plate

- 20mm thick mild steel griddle plate
- 20 MJ griddle burners per every 305mm section
- Piezo ignition

### Chargrill

- Heavy duty cast iron reversible grates provide greater control when cooking, energy efficiency, and offer two char pattern options
- 2 levelling options - flat or gradient
- 2x 20 MJ inline radiant burners per every 305mm section
- Ceramic rocks option available to increase heat retention and flavour

### Oven

- 100°C - 280°C thermostatic control
- Piezo ignition
- Oven and door are fully insulated with vitreous enamel for even heat distribution and easy cleaning
- GN 1/1 capacity with 3 position racking
- Heavy duty chrome wire rack supports designed for easy removal

### Oven Options

- Gas static, fan forced and convection oven
- Electric static, fan forced and convection oven



Cert. No.  
AGA 7732



**MIDDLEBY GOLDSTEIN**

1800 013 123 | +61 2 9604 7333  
sales@middleby.com.au  
middleby.com.au

**VIC - TAS** - 47 Stubbs Street, Kensington VIC 3031  
**QLD** - U12, 210 Queensport Rd Nth, Murarrie QLD 4172  
**WA** - U2, 9 Meares Way, Canning Vale WA 6155

**HEAD OFFICE  
AND MANUFACTURING PLANT**  
211-217 Woodpark Road, Smithfield NSW 2164

v1\_2024



# PF628-X, PF12G428-X, PF24G228-X, PF36G28-X, PF12Q428-X, PF24Q228-X, PF36Q28-X 800 SERIES RANGES 700mm GAS STATIC OVEN

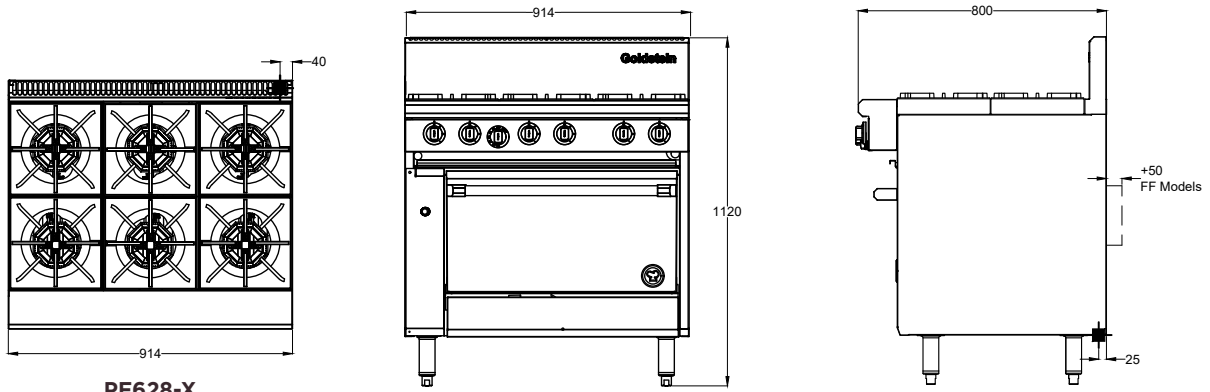

PF628-X

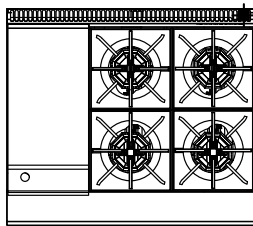

PF12G428-X

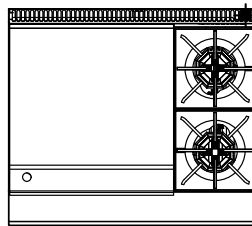

PF24G228-X

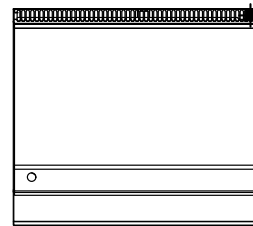

PF36G28-X

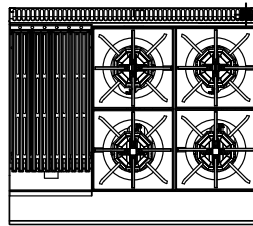

PF12Q428-X

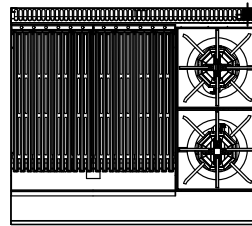

PF24Q228-X

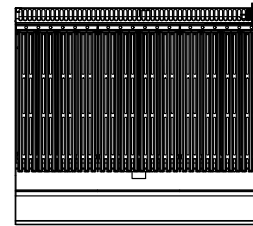

PF36Q28-X

## SPECIFICATIONS

<b>Dimensions (WxDxH)</b>	914 x 800 x 1120 mm	
<b>Working height</b>	914 mm	
<b>Oven size (WxDxH)</b>	700 x 560 x 355 mm	
<b>Oven Rack Positions</b>	3	
<b>Griddle size</b>	<b>PF12G428-X</b>	305 x 520 x 20 mm
	<b>PF24G228-X</b>	610 x 520 x 20 mm
	<b>PF36G28-X</b>	914 x 520 x 20 mm
<b>Grill size</b>	<b>PF12Q428-X</b>	305 x 510 mm
	<b>PF24Q228-X</b>	610 x 510 mm
	<b>PF36Q28-X</b>	914 x 510 mm

<b>Gas connection</b>	3/4" BSPM	
<b>Rating NG/LPG</b>	<b>PF628-X</b>	226/228 MJ
	<b>PF12G428-X</b>	180/182 MJ
	<b>PF24G228-X</b>	134/136 MJ
<b>Packed dimensions</b>	<b>PF36G28-X</b>	88/90 MJ
	<b>PF12Q428-X</b>	200/200 MJ
	<b>PF24Q228-X</b>	174/172 MJ
<b>PF36Q28-X</b>	148/144 MJ	

Available in Natural and LP gas

## INSTALLATION CLEARANCES (minimum)

<b>Combustible Material</b>	<b>Sides</b>	250* mm	<b>Non-combustible Material</b>	<b>Sides</b>	0 mm
	<b>Back</b>	50 mm		<b>Back</b>	0 mm

Note: \* If adjacent surface is of combustible material and is 100mm below the cooking surface, then only 50mm clearance is required.

Please note, due to ongoing product development and improvement, we reserve the right to change product design and specification at any time without notice.



1800 013 123 | +61 2 9604 7333  
sales@middleby.com.au  
middleby.com.au

**VIC - TAS** - 47 Stubbs Street, Kensington VIC 3031  
**QLD** - U12, 210 Queensport Rd Nth, Murarrie QLD 4172  
**WA** - U2, 9 Meares Way, Canning Vale WA 6155

**HEAD OFFICE AND MANUFACTURING PLANT**  
211-217 Woodpark Road, Smithfield NSW 2164

v1\_2024



# 800 SERIES RANGES 700mm OVEN OPTIONS

Model Number	Dimensions (mm) WxDxH	Oven size (mm) WxDxH	Rating (MJ) NG/LPG	Rating (kW)
--------------	--------------------------	-------------------------	-----------------------	----------------

## 6 burners

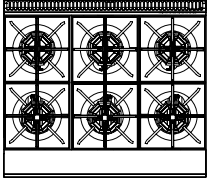

<b>PF628FF-X</b> Gas Fan Forced Oven	914 x 850 x 1120	700 x 525 x 355	226/228	
<b>PF628EFF-X</b> Electric Fan Forced Oven	914 x 850 x 1120	700 x 525 x 305	198/198	6.4
<b>PFC628-X</b> Gas Convection Oven	914 x 900 x 1120	690 x 410 x 320	226/228	10
<b>PFC628E-X</b> Electric Convection Oven	914 x 900 x 1120	690 x 410 x 320	198/198	10
<b>PF628E-X</b> Electric Static Oven	914 x 800 x 1120	700 x 560 x 305	198/198	6.4

## 4 burners, 305mm griddle plate

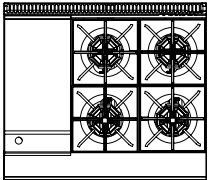

<b>PF12G428FF-X</b> Gas Fan Forced Oven	914 x 850 x 1120	700 x 525 x 355	180/182	
<b>PF12G428EFF-X</b> Electric Fan Forced Oven	914 x 850 x 1120	700 x 525 x 305	152/152	6.4
<b>PFC12G428-X</b> Gas Convection Oven	914 x 900 x 1120	690 x 410 x 320	180/182	10
<b>PFC12G428E-X</b> Electric Convection Oven	914 x 900 x 1120	690 x 410 x 320	152/152	10
<b>PF12G428E-X</b> Electric Static Oven	914 x 800 x 1120	700 x 560 x 305	152/152	6.4

## 2 burners, 610mm griddle plate

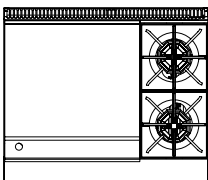

<b>PF24G228FF-X</b> Gas Fan Forced Oven	914 x 850 x 1120	700 x 525 x 355	134/136	
<b>PF24G228EFF-X</b> Electric Fan Forced Oven	914 x 850 x 1120	700 x 525 x 305	106/106	6.4
<b>PFC24G228-X</b> Gas Convection Oven	914 x 900 x 1120	690 x 410 x 320	134/136	10
<b>PFC24G228E-X</b> Electric Convection Oven	914 x 900 x 1120	690 x 410 x 320	106/106	10
<b>PF24G228E-X</b> Electric Static Oven	914 x 800 x 1120	700 x 560 x 305	106/106	6.4

## 914mm griddle plate

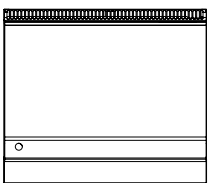

<b>PF36G28FF-X</b> Gas Fan Forced Oven	914 x 850 x 1120	700 x 525 x 355	88/90	
<b>PF36G28EFF-X</b> Electric Fan Forced Oven	914 x 850 x 1120	700 x 525 x 305	60/60	6.4
<b>PFC36G28-X</b> Gas Convection Oven	914 x 900 x 1120	690 x 410 x 320	88/90	10
<b>PFC36G28E-X</b> Electric Convection Oven	914 x 900 x 1120	690 x 410 x 320	60/60	10
<b>PF36G28E-X</b> Electric Static Oven	914 x 800 x 1120	700 x 560 x 305	60/60	6.4

Please note, due to ongoing product development and improvement, we reserve the right to change product design and specification at any time without notice.





# 800 SERIES RANGES 700mm OVEN OPTIONS

Model Number	Dimensions (mm) WxDxH	Oven size (mm) WxDxH	Rating (MJ) NG/LPG	Rating (kW)
--------------	--------------------------	-------------------------	-----------------------	----------------

4 burners, 305mm chargrill

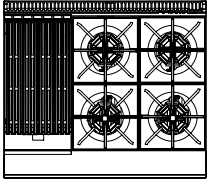

<b>PF12Q428FF-X</b> Gas Fan Forced Oven	914 x 850 x 1120	700 x 525 x 355	200/200	
<b>PF12Q428EFF-X</b> Electric Fan Forced Oven	914 x 850 x 1120	700 x 525 x 305	172/170	6.4
<b>PFC12Q428-X</b> Gas Convection Oven	914 x 900 x 1120	690 x 410 x 320	200/200	10
<b>PFC12Q428E-X</b> Electric Convection Oven	914 x 900 x 1120	690 x 410 x 320	172/170	10
<b>PF12Q428E-X</b> Electric Static Oven	914 x 800 x 1120	700 x 560 x 305	172/170	6.4

2 burners, 610mm chargrill

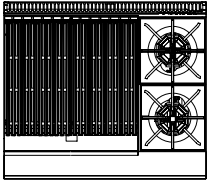

<b>PF24Q228FF-X</b> Gas Fan Forced Oven	914 x 850 x 1120	700 x 525 x 355	174/172	
<b>PF24Q228EFF-X</b> Electric Fan Forced Oven	914 x 850 x 1120	700 x 525 x 305	146/142	6.4
<b>PFC24Q228-X</b> Gas Convection Oven	914 x 900 x 1120	690 x 410 x 320	174/172	10
<b>PFC24Q228E-X</b> Electric Convection Oven	914 x 900 x 1120	690 x 410 x 320	146/142	10
<b>PF24Q228E-X</b> Electric Static Oven	914 x 800 x 1120	700 x 560 x 305	146/142	6.4

914mm char grill

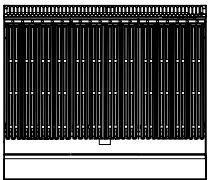

<b>PF36Q28FF-X</b> Gas Fan Forced Oven	914 x 850 x 1120	700 x 525 x 355	148/144	
<b>PF36Q28EFF-X</b> Electric Fan Forced Oven	914 x 850 x 1120	700 x 525 x 305	120/114	6.4
<b>PFC36Q28-X</b> Gas Convection Oven	914 x 900 x 1120	690 x 410 x 320	148/144	10
<b>PFC36Q28E-X</b> Electric Convection Oven	914 x 900 x 1120	690 x 410 x 320	120/114	10
<b>PF36Q28E-X</b> Electric Static Oven	914 x 800 x 1120	700 x 560 x 305	120/114	6.4

Please note, due to ongoing product development and improvement, we reserve the right to change product design and specification at any time without notice.



1800 013 123 | +61 2 9604 7333  
sales@middleby.com.au  
middleby.com.au

VIC - TAS - 47 Stubbs Street, Kensington VIC 3031  
QLD - U12, 210 Queensport Rd Nth, Murarrie QLD 4172  
WA - U2, 9 Meares Way, Canning Vale WA 6155

HEAD OFFICE  
AND MANUFACTURING PLANT  
211-217 Woodpark Road, Smithfield NSW 2164

v1\_2024