



Electric deck oven for pizza 2 decks composition

iDeck consists of one or two baking chambers and an optional proofer or stand. The oven's baking surface is made of refractory material, providing the perfect heat distribution over the whole surface. This oven is particularly suitable for direct or indirect pizza baking. Temperature adjustment is electro-mechanical, with independent control of the ceiling and floor heating elements. The oven door is hinged at the bottom, with a tempered glass window to check the product during baking. The stand consists of a painted metal structure, while the proofer is a stainless steel cabinet equipped with a heating thermostat. The proofer can reach the maximum temperature of 65°C(149°F), whereas the maximum temperature of the baking chamber is 450°C (842°F).



FUNCTIONING

- Heating by armoured heating elements
- Separate heating element control by mean contactors that are controlled by thermostats
- Maximum temperature reached 450°C
- Continuous measurement of temperature by probe indicator

CONSTRUCTION

- Front structure made in folded stainless steel
- Oven panels made pre-painted metal sheets
- Door in stainless steel with shutter with hinge at bottom with balancing spring
- Door handle in stainless steel
- Tempered crystal glass
- Control panel on the right front side
- Baking surface in refractory brick
- Upper and lateral structure in aluminized sheet
- Thermal insulation in mineral wool

BAKING ELEMENT INTERNAL DIMENSIONS

Internal height	140 mm
Internal depth	1056 mm
Internal width	1056 mm
Baking surface	1,15 m ²

STANDARD EQUIPMENT

- Illumination by halogen lamp
- Independent maximum temperature safety device (only electronic version)

ACCESSORIES

- Proofer on wheels height 1000 mm
- Stand height 600, 900 mm
- 4 wheels kit
- Additional trayholder slides
- Stacking kit
- Hood

TOP VIEW

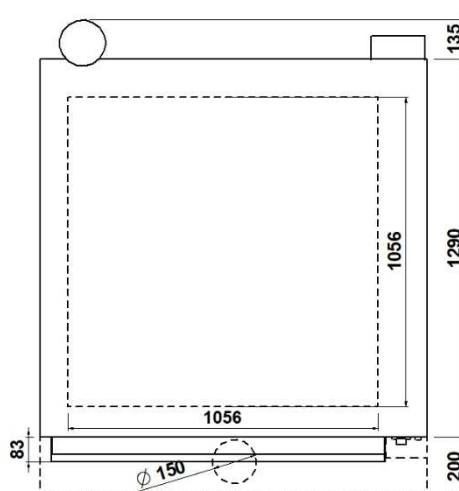

PM 105.105

(assembled with stand height 900mm)

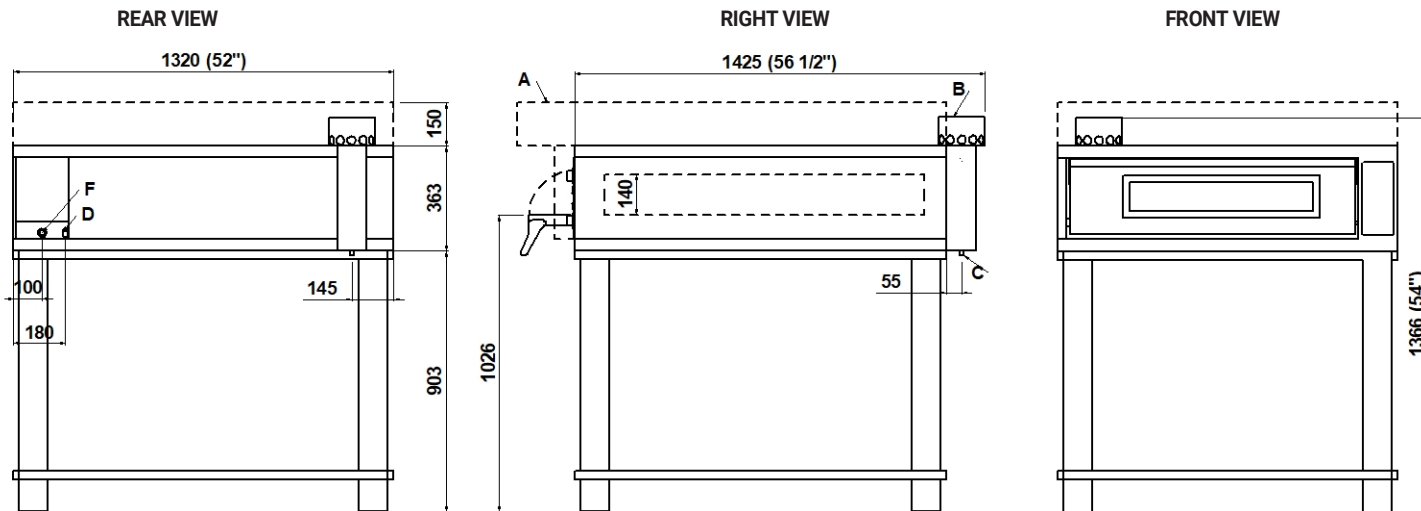

NOTE: The dimensions indicated in the views are in millimeters.

A Ø150 hood steam collector	B Ø INT. 157 steam exhaust	C Ø12 condensate exhaust	D M6 equipotential screw
F fairleads			

EXTERNAL DIMENSIONS

External height	463 mm
External depth	1425 mm
External width	1320 mm
Weight	164 kg

SHIPPING INFORMATION

Packed oven sizes:

Height	550 mm
Depth	1550 mm
Width	1410 mm
Weight	(164+23) kg

FEEDING AND POWER

Standard feeding	A.C. V400 3N
Feeding on request	A.C. V230 3
Frequency	50/60 Hz
Max power	11,6 kW
*Average power cons	5,8 kWh
Connecting cable	type H07RN-F
	5x6mm ² (V400 3N)
	4x10mm ² (V230 3)
Prover power supply (optional)	A.C. V230 1N 50/60 Hz
Max power	1,5 kW
*Average power cons	0,8 kWh
Conn. cable type H07RN-F	3x1,5mm ²

TOTAL BAKING CAPACITY

Tray (600x400)mm	4
Pizza diameter 300mm	9
Pizza diameter 450mm	4

* This value is subject to variation according to the way in which the equipment is used
 NOTE: MORETTI FORNI S.P.A. reserves the right to modify the characteristics of the products illustrated in this publication without prior notice

PD 105.105

(assembled with stand height 900mm)

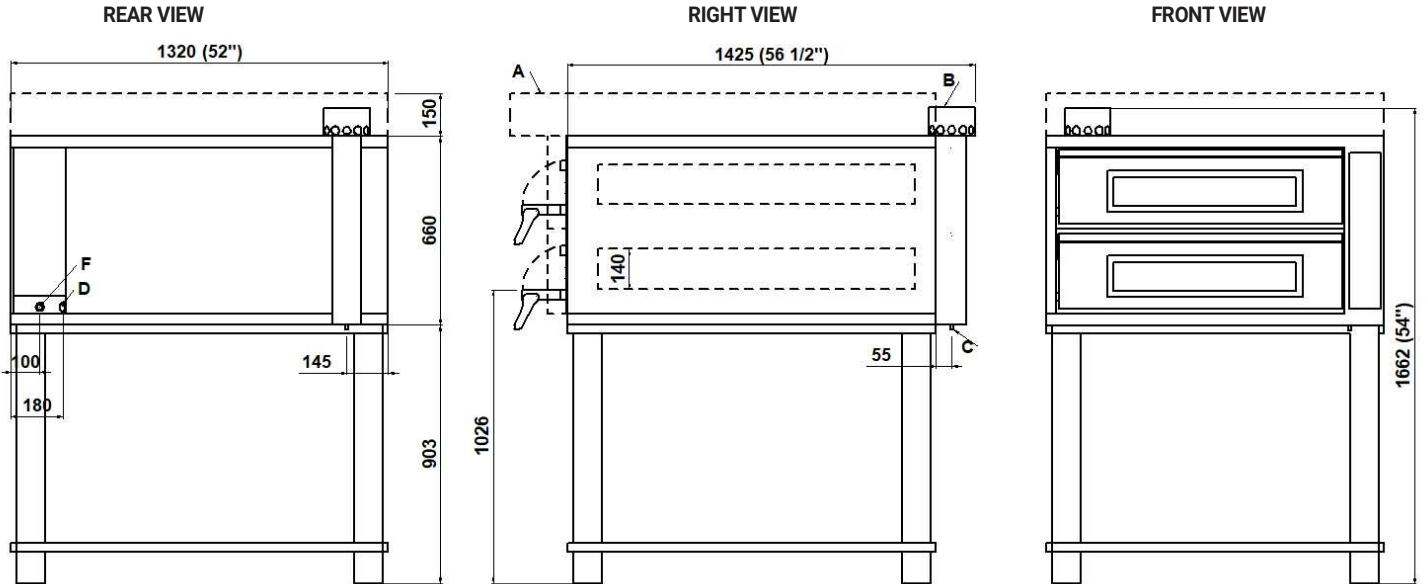

NOTE: The dimensions indicated in the views are in millimeters.

A Ø150 hood steam collector	B Ø INT. 157 steam exhaust	C Ø12 condensate exhaust	D M6 equipotential screw
F fairleads			

EXTERNAL DIMENSIONS

External height	760 mm
External depth	1425 mm
External width	1320 mm
Weight	282 kg

SHIPPING INFORMATION

Packed oven sizes:	
Max height	910 mm
Max depth	1550 mm
Max width	1410 mm
Weight	(282+25) kg

FEEDING AND POWER

Standard power supply	
A.C. V400 3N	
Optional power supply	
A.C. V230 3	
Frequency	50/60 Hz
Max power	23,1 kW
*Average power cons	11,6 kWh
Connecting cable	
type H07RN-F	
5x10mm ² (V400 3N)	
4x16mm ² (V230 3)	
Prover power supply (optional)	
A.C. V230 1N 50/60 Hz	
Max power	1,5 kW
*Average power cons	0,8 kWh
Conn. cable type H07RN-F 3x1,5mm ²	

TOTAL BAKING CAPACITY

Tray (600x400)mm	8
Pizza diameter 300mm	18
Pizza diameter 450mm	8

* This value is subject to variation according to the way in which the equipment is used
NOTE: MORETTI FORNI S.P.A. reserves the right to modify the characteristics of the products illustrated in this publication without prior notice