



Electric pizza oven

Neapolis consists of a baking unit and a prover. The baking surface is made of "Biscotto" brick, which ensures the perfect heat distribution in all baking areas, making this oven particularly suitable for Neapolitan pizza. Electronic temperature management, independent power control of ceiling and floor coiled heating elements. The oven is equipped with a high-insulated removable door to close its mouth. The maximum baking temperature is 510°C (950°F). The prover is made of a painted steel structure, featuring castor wheels with safety break not at sight. Prover maximum temperature is 65°C (150°F).



FUNCTIONING

- Heating via bare-wire coil resistors with optimised temperature balancing
- Maximum temperature of 510°C (950°F)
- Patented Self-stabilising internal deflectors situated on dome oven chamber surface to minimise leakage and ensure uniform heat distribution
- Electronic temperature management with independent adjustment of ceiling and floor
- Continuous temperature monitoring with thermocouple
- Steam draught adjustable via a manual valve

STANDARD EQUIPMENT

- Removable oven chamber stainless-steel door, with increased insulation and heat-resistant handle
- Stainless-steel door supports
- Protected lighting thanks to hidden double halogen lamps
- Lateral refractory protection in oven chamber opening
- Daily power-on timer
- ECO-STAND BY TECHNOLOGY™ for work breaks
- 20 customisable programs
- Pre-set programs: temperature rises, average setting, maximum setting, heat-regulation cleaning
- Separate max. temperature safety device
- Anchoring system for lifting
- Heat-regulated Leavening prover with internal lighting and hidden controllable castor wheels

EXTERNAL CONSTRUCTION

- Sheet steel structure coated with high-temperature epoxy powder paint finish
- External panelling with "post-industrial" finish
- "Inox Vintage" coated front panel
- Black granite landing with slot for thermal bridge break
- Cast-iron oven opening
- Rounded fume hood with Neapolis® design
- Black coated stainless steel cylindrical flue
- Front-facing digital control panel and retractable sliding panel

INTERNAL CONSTRUCTION

- Oven chamber made from refractory material
- 5,5cm thick patented slab with interchangeable 'Biscuit' baking surface positioned on top of heating plate made from perforated refractory material
- Resistor inserted inside the ceiling and floor perforated refractors
- Patented High-density dual insulation for high temperatures
- Insulation with heated joints and a COOL AROUND® TECHNOLOGY air space

ACCESSORY TO BE PURCHASED AS OPTIONAL

- Tray holder slides for Leavening prover
- Motor for hood vapours extraction 250m3/h
- Heavy Duty Pack for internal oven chamber protection
- Stainless steel door with a special high-temperatures-resistant glass for long baking
- Specific pizza peel and turning peel for Neapolis
- Peel holder with stand for removable door

Neapolis 9

(assembled with leavening prover height 1050mm)

TOP VIEW

REAR VIEW

RIGHT SIDE VIEW

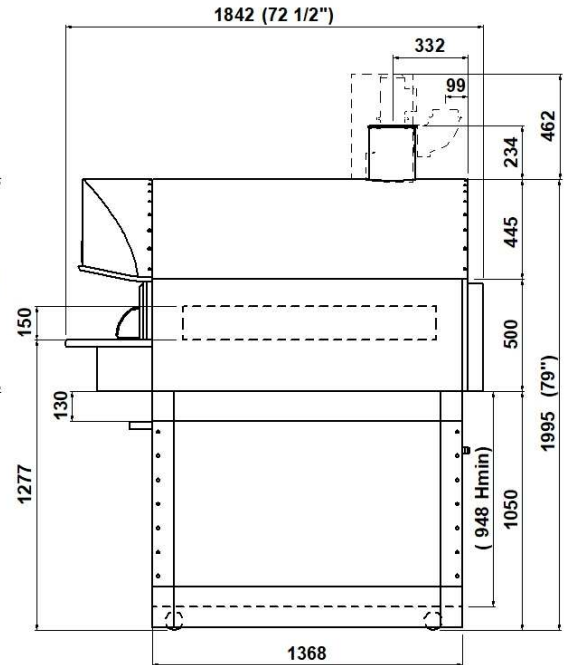
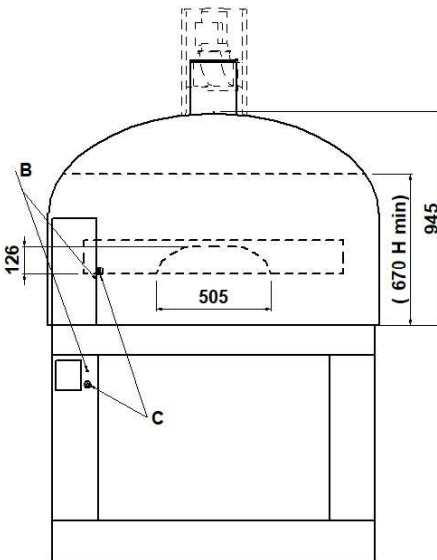
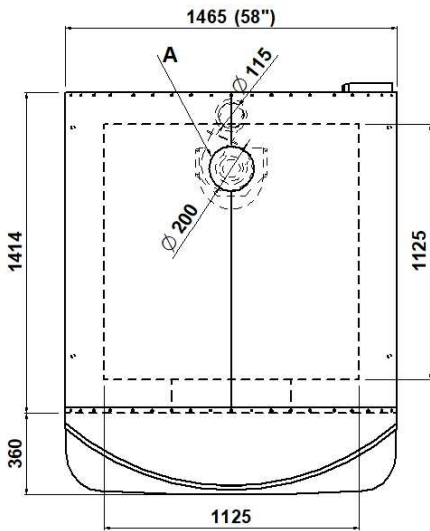

NOTE: The dimensions shown in these diagrams are in millimeters.

A
steam exhaust

B
M6
equipotential screws

C
fairleads

EXTERNAL DIMENSIONS

External height	1995mm
External depth	1842mm
External width	1465mm
Weight	725kg

INTERNAL DIMENSIONS

Internal height	150mm
Internal depth	1125mm
Internal width	1125mm
Baking surface	(1.27mq ²)

TOTAL BAKING CAPACITY

Pizza diameter 330mm	9
----------------------	---

LEAVENING PROVER CAPACITY

Container cm.(60x40 H7) max	24
Container cm.(60x40 H10) max	24
Container cm.(60x40 H13) max	24

SHIPPING INFORMATION

Packed in wooden crate	
Height	2200mm
Depth	2000mm
Width	1680mm
Weight	(725+136)kg

In case of separate packaging for aerial shipments:

Oven	
Height	1300mm
Depth	2000mm
Width	1680mm
Weight	(560+85)kg

Leavening prover	
Height	1300mm
Depth	2000mm
Width	1680mm
Weight	(165+90)kg

FEEDING AND POWER

Standard feeding	
A.C. V400 3N	
Feeding on request	
A.C. V230 3	
Frequency	50/60Hz
Max power	21,9kW
*Average power cons.	6,8kWh

Connecting cable
tipo H07RN-F
5x10mm² (V400 3N)
4x16mm² (V230 3)

Power supply Leavening prover	
A.C. V230 1N 50/60 Hz	
Max power	1.5kW
*Average Power cons.	0.8kWh
Connecting cable type	H07RN-F
	3x1,5mm ²

*This value is subject to variation according to the way in which the equipment is used

NOTE: MORETTI FORNI S.P.A. reserves the right to modify the characteristics of the products illustrated in this publication without prior notice

TECHNICAL DATA

ONLY FOR UL MODEL

FEEDING AND POWER (EACH DECK NEEDS TO BE CONNECTED INDEPENDENTLY AND THE LOAD SHOWN BELOW ARE PER DECK)	A.C. V240 3ph 60Hz	Standard feeding	Max power	kW	21.5
			*Medium cons/hour	kWh	6.8
			Ampère Max	A/DECK	51.8
			Connecting cable	AWG/DECK	6
	A.C. V208 3ph 60Hz	Feeding on request	Max power	kW	21.5
			*Medium cons/hour	kWh	6.8
			Ampère Max	A	59.8
			Connecting cable	AWG/DECK	6
	A.C. V(208/240) 1ph 60Hz	Proofer	Max power	kW	1,8
			*Medium cons/hour	kWh	0,9
			Ampère Max	A/DECK	7,5
			Connecting cable	AWG/DECK	14

* This value is subject to variation according to the way in which the equipment is used

NOTE: MORETTI FORNI S.P.A. reserves the right to modify the characteristics of the products illustrated in this publication without prior notice