

CABINET DIMENSIONS & SPECIFICATIONS

MODEL	CABINET					PANS	WATER FILL	TEMP	DISPLAY AREA	POWER WITH OVERHEAD HEATING & LEDS		CONNECTION ELECTRICAL POWER CORD 3000MM	VOLTAGE	PACKED FOR SHIPPING			
	LENGTH [MM]	DEPTH [MM]	HEIGHT [MM]	WEIGHT [KG]	CUT OUTS					LITERS	DEG C			M2	KW 230V	AMPS	NZ/AUS/UK
LSBM3	1145	690	555	86	1120X635	3 x 1/1 65mm Gastro Pans	57	75 -95	0.53	3.45	15	20 AMP LEAD ONLY	220-240V	1250	770	670	86
LSBM4	1485	690	555	106	1460X635	4 x 1/1 65mm Gastro Pans	75	75 -95	0.73	4.30	18.7	30 AMP LEAD ONLY	220-240V	1590	770	670	106
LSBM5	1825	690	555	121	1800X635	5 x 1/1 65mm Gastro Pans	93	75 -95	0.92	5.75	25	30 AMP LEAD ONLY	220-240V	1930	770	670	121
LSBM6	2165	690	555	140	2140X635	6 x 1/1 65mm Gastro Pans	113	75 -95	1.10	6.56	28.5	40 AMP LEAD ONLY	220-240V	2270	770	670	140

PRODUCT FEATURES

- Dual purpose used wet or dry
- Auto Fill - Dry elements
- Overhead halogen lights
- with adjustable dimmer
- Full size pans 65mm deep supplied (max 100mm)

LSBM LEFT SIDE ELEVATION

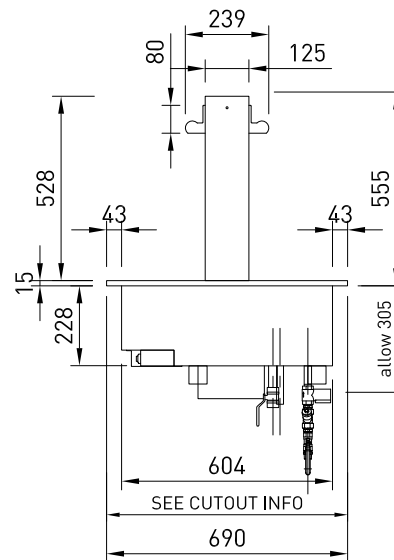

GASTRO PANS

Units supplied with 1/1 pans at 65mm deep, max pan depth is 100mm

ELECTRICAL POWER

Electrical power cord 3000mm 1 phase connection required. Unit must be hard wired on site to isolation switch.

WATER DRAINAGE

Screw on stop cock valve drain pipe Ideally drain connected to waste. Overflow flexible waste pipe 19mm dia.1000 mm length from spigot must be connected to waste.

INDUSTRY KITCHENS

www.industrykitchens.com.au 1800 611 058

ASSEMBLY REQUIRED

Prior to installation see, installation guidelines, ventilation requirements and drainage options documents

LSBM3

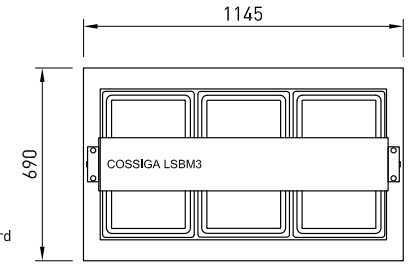
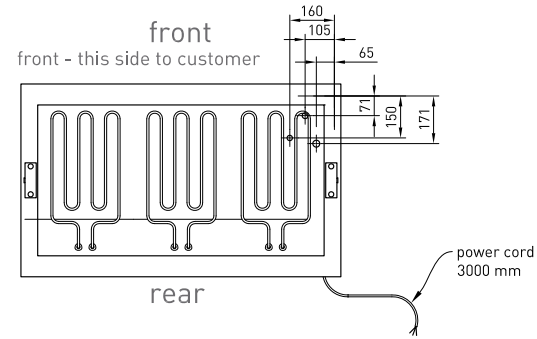
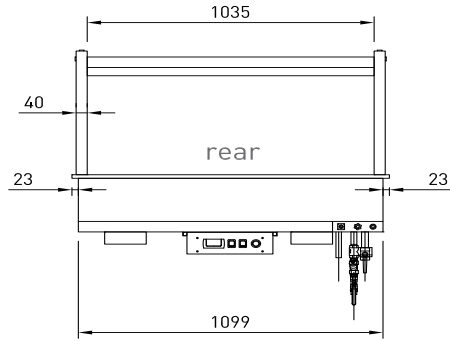
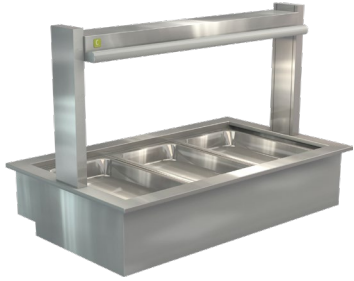

LSBM4

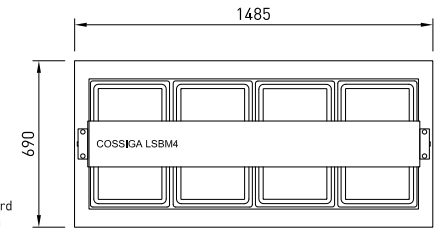
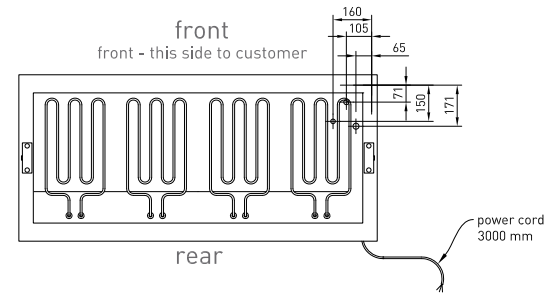
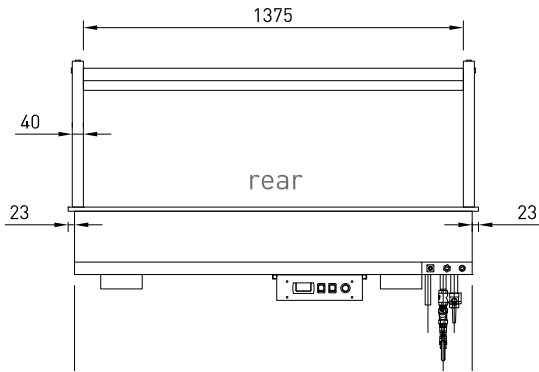
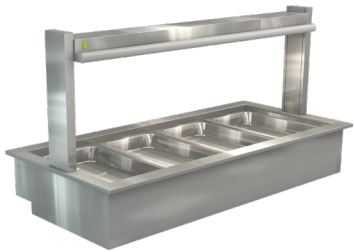

LSBM5

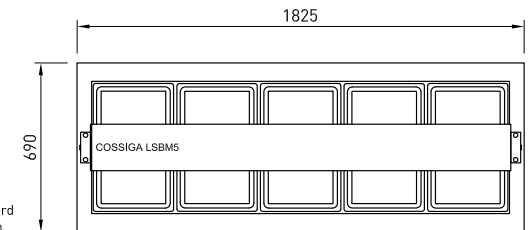
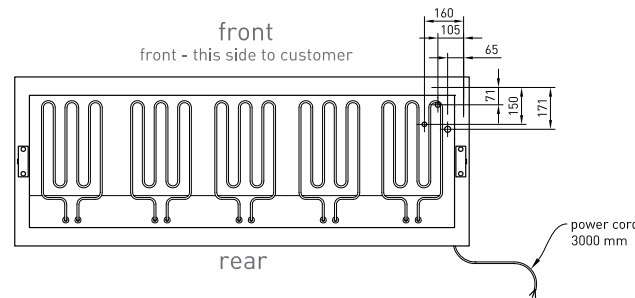
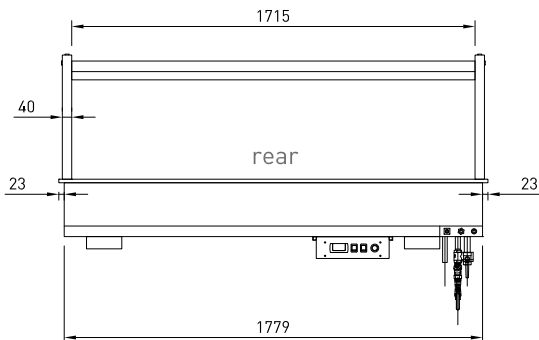

ASSEMBLY REQUIRED

LSBM6

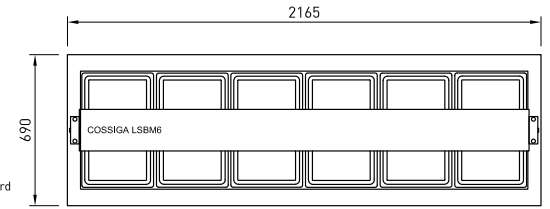
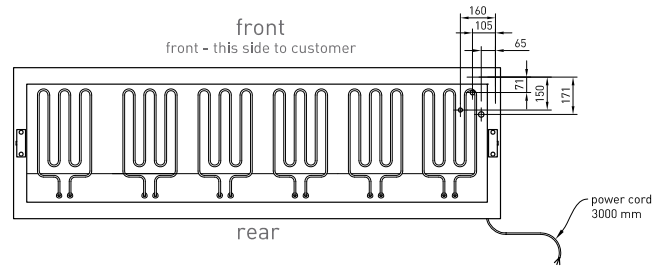
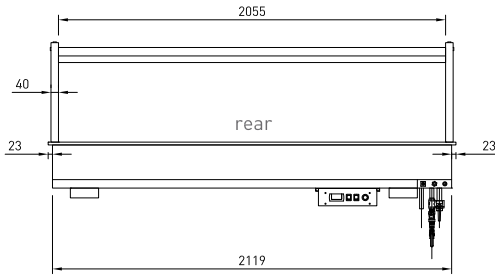
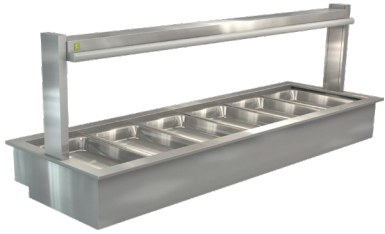

ASSEMBLY REQUIRED