



CTR-Series Translation of the original operating instructions

Table of contents

1	Introduction	4
1.1	About these operating instructions	4
1.2	Copyright	4
1.3	Proper use	4
1.4	Improper use	4
2	Safety	5
2.1	Safety notes	5
2.2	Operator obligations	6
2.3	User obligations	6
2.4	Mechanical dangers	6
2.5	Electrical dangers	7
2.6	Thermal dangers	7
2.7	Handling of chemicals	7
2.8	Safety settings	7
2.9	Notes on spare parts	7
3	Machine description	8
3.1	Description of function	8
3.2	Overview	9
3.3	Display	11
3.4	Wash modes	12
3.5	Info display	13
3.6	Rinse aid and detergent	14
3.7	Suction tube with level control	15
3.8	Technical data	16
4	Software	17
4.1	Chef menu	17
4.1.1	Hygiene logbook	18
4.1.2	Operating data	18
4.1.3	Dosage	18
4.1.4	Timer	20
4.1.5	Descale	21
4.1.6	Brightness	22
4.1.7	Sounds	22
4.1.8	Date / time	23
4.1.9	Language	23
4.1.10	Units	23
4.1.11	CONNECTED WASH	24
4.1.12	Water back-flow counter	24
5	Commissioning	25
5.1	Installing the warewasher	25
5.2	Connecting the warewasher	25
5.2.1	Water connection	25
5.2.2	Electrical connection	27
5.3	Connecting external dosing devices	29
5.3.1	Terminals	29
5.3.2	Electrical connection	30
5.4	Before working with the warewasher	30

5.5	Check for completeness	31
6	Operation.....	32
6.1	Switch on the warewasher.....	32
6.2	Washing.....	32
6.3	Changing the tank water.....	34
6.4	Switch off the warewasher.....	34
7	Notifications.....	35
7.1	Pictograms.....	35
7.2	Display the error with error code.....	36
7.3	Poor wash result.....	37
8	Cleaning and maintenance.....	38
8.1	Cleaning the warewasher during operation	38
8.2	Drainage programme.....	39
8.3	Fast drainage programme	40
8.4	Replace the container.....	41
8.5	Change the chemical product.....	41
8.6	Cleaning the interior.....	42
8.7	Cleaning the outside of the warewasher.....	42
8.8	Descale the warewasher	42
8.9	Maintenance by the customer service department.....	42
9	Disassembly and disposal.....	43
9.1	Taking the warewasher out of operation for long production stops	43
9.2	Disassembly	43
9.3	Disposal	43
10	Annex.....	44
10.1	Declaration of Conformity	44

1 Introduction

1.1 About these operating instructions

These operating instructions contain information that ensures the safe operation of the warewasher. It constitutes a component of the warewasher and must be stored in a place which is accessible for the user. To be able to work safely with the warewasher, the safety and operating instructions provided must be observed. Compliance with the valid national accident prevention regulations and general safety provisions must be ensured.

1.2 Copyright

The instructions are protected for the manufacturer by copyright.

The instructions contain guidelines and drawings or parts of drawings of a technical nature, which may not be reproduced, distributed, used for the purposes of competitors without authorisation or shared with others, either in whole or in part.

The operator of the warewasher is permitted to make copies – even in extracts – expressly for internal application as regards the operation of the dishwasher. The manufacturer is entitled to claim damages for any infringements. Further rights reserved.

© 2020 by Winterhalter Gastronom GmbH

1.3 Proper use

- The warewasher is intended only for washing dishes, cutlery, glasses trays and gastronomic containers for gastronomic and similar use.
- Operate the warewasher with Winterhalter chemicals. If other chemicals are used, please contact Winterhalter or an authorised customer service team in advance.
- The warewasher is a technical device for commercial use and is not intended for private use.
- Always operate the warewasher only as described in these operating instructions.

1.4 Improper use

- Do not wash without a wash rack.
- Do not make any changes, additions or modifications without the approval of the manufacturer.
- Winterhalter Gastronom GmbH assumes no liability for any damage caused by improper use of the warewasher.

2 Safety

2.1 Safety notes

Winterhalter Gastronom GmbH assumes no liability or warranty in the event of non-compliance with these safety and operating instructions.

General safety notes

- This warewasher can be used by children aged 8 years and above and by persons with reduced physical, sensory, or mental capabilities, or lack of experience and knowledge, if they are supervised or have been instructed in the safe use of the machine and understand the dangers involved.
- Children must not play with the warewasher.
- Cleaning and user maintenance should not be carried out by children without supervision.
- Read through the safety notes and operating instructions carefully.
- Retain the operating instructions for future reference.
- Work with the warewasher only after having read and understood the operating instructions and the safety notes.
- Allow the Winterhalter Customer Service Department to provide information about the operation and functioning of the warewasher.
- Train operating personnel in handling the warewasher and point out any and all safety notes. Repeat the training sessions at regular intervals to prevent accidents.
- Operate this warewasher only when it is in perfect condition.
- A damaged or leaking warewasher may endanger safety. If malfunctions occur, switch off the warewasher immediately and switch it back on only once the malfunction has been remedied. Switch off the on-site mains isolation switch (main switch) to ensure the warewasher is voltage-free.
- Allow the installer or an electrician to remedy on-site water and electricity supply malfunctions.
- Allow other malfunctions to be remedied by an authorised service technician or your dealer.
- Once the work is complete, close the on-site water supply.
- Once the work is complete, switch off the on-site mains isolation switch.

Electrical safety

- The electrical safety of this warewasher is guaranteed only if it is connected to a correctly installed protective circuit. It is crucial that this basic safety requirement is tested and, in case of doubt, that the on-site installation is checked by a qualified electrician. Winterhalter cannot be held responsible for damage caused by a missing or broken protective conductor (e.g. electrical shock).
- Do not open any machine covers or machine parts if doing so requires tools.

Maintenance and repairs

- Maintenance work and repairs may be carried out only by authorised Winterhalter service technicians. Improper maintenance or repairs may cause significant danger to the user, for which Winterhalter is not liable.
- When performing installation and maintenance work as well as repairs, unplug the warewasher from the mains supply. Electricity consumers (heating elements) are under voltage until the on-site mains isolation switch has been activated.
- Only original Winterhalter spare parts may be used for maintenance and repairs. Using third-party spare parts voids the warranty.
- If the mains cable is damaged, to prevent hazards it must be replaced by Winterhalter or its Customer Service or another qualified person. The mains cable must be an oil-resistant, sheathed and flexible cable. The cable type H07RN-F is recommended.

2.2 Operator obligations

This commercial warewasher is intended for use in catering establishments. The operator of the warewasher is therefore subject to the legal obligations for occupational safety. In addition to the warning and safety notes in these operating instructions, the operator must comply with the current provisions regarding safety, accident prevention and environmental protection for the area of application of the warewasher. To ensure safe use of the warewasher, the operator must take the following measures:

- Have the warewasher connected according to the locally applicable standards and the regulations by authorised mechanics (water, waste water, electrical system).
- Provide the user with information on the provisions regarding occupational safety.
- Ensure that all persons working on the warewasher have read the operating instructions and the quick guide. Furthermore, the user must take part in regular training on use of the warewasher and must be informed of any possible danger. If necessary, contact the Winterhalter Customer Service regarding operation and functioning of the warewasher.
- Provide the user with the operating instructions and short operating instructions.
- Train the user on use of the chemicals.
- Operate this warewasher only when it is in perfect technical and hygienic condition.

2.3 User obligations

In addition to the warning and safety notes in these operating instructions, the operator must comply with the current provisions regarding safety, accident prevention and environmental protection for the area of application of the commercial warewasher.

In particular, the user must take the following measures:

- Adhere to the current provisions regarding occupational safety.
- Fulfil the allocated responsibilities for installation, operation, maintenance and cleaning of the warewasher properly.
- Switch off the warewasher immediately using the mains isolation switch (main switch) should a malfunction occur. Switch the warewasher back on only once the cause of the malfunction has been remedied by an authorised service technician.
- Ensure cleanliness and tidiness around the warewasher.
- Never drink the wash water and avoid contact with the skin.

2.4 Mechanical dangers



Caution

Possible risk of injury from pointed and sharp dishes

Injuries may occur when loading and emptying the wash rack.

- Wash cutlery upright in the cutlery holder or laid in the flat basket.



Warning

Risk of slipping on a wet floor

Moisture may build up on the floor around the warewasher when operating the warewasher.

- Prevent any build-up of dirt on the floor.
- Wear personal protective equipment (non-slip footwear).



Caution

Possible risk of injury due to sharp edges

Cut injuries may occur when cleaning the warewasher with wet hands.

- Wear protective gloves.

2.5 Electrical dangers



Danger

Electric shock from live components

A fatal electric shock can occur when the warewasher and its additional devices are connected to the electrical mains supply.

- The warewasher and its additional devices may be connected to the electrical mains supply only by a specialist company registered within the electrical trade and approved by the energy supplier.
- All locally applicable standards and regulations must be observed during the connection to the electrical mains supply.
- When performing installation and maintenance work as well as repairs, unplug the warewasher from the mains supply. Check that there is no voltage present.



Danger

Electric shock from live components

A fatal electric shock can occur during installation and maintenance work and when carrying out repairs.

- Isolate and lockout the mains supply to the warewasher.
- Check that there is no voltage present.

2.6 Thermal dangers



Caution

Damage due to hot components

Insufficient distance between electrical cables or dosing tubes and hot components when installing accessory devices can lead to damage.

- Ensure to lay electrical cables or dosing tubes at a sufficient distance.

2.7 Handling of chemicals



Danger

Risk of chemical burns due to chemicals

Contact between chemicals with the skin or eyes can lead to severe burns or serious eye damage.

- In the event of contact with the eyes or skin, rinse thoroughly with tap water. Seek medical attention as required.
- Wear protective clothing, protective gloves and protective goggles.
- Observe the danger and safety notes on the container and safety data sheet.



Danger

Risk of poisoning due to chemicals

Contact with the chemicals via the mouth can lead to severe poisoning.

- Never drink or transfer chemicals into other containers.
- Observe the danger and safety notes on the safety data sheet.
- Observe the danger and safety notes on the container and safety data sheet.

2.8 Safety settings

The commercial warewasher has been built in accordance with the applicable legal provisions and is safe to operate. Danger areas that cannot be excluded by design are fitted with safety devices.

- Door limit switch
- Table limit switch
- Geared motor limit switch overload protection

All safety devices must be present and functional when operating the commercial warewasher.

Safety devices must not be changed or modified.

Carry out a functional check of the safety devices after concluding maintenance and repair work.

2.9 Notes on spare parts

Only original Winterhalter spare parts may be used for maintenance and repairs. Using third-party spare parts voids the warranty. The information in the spare parts catalogues is decisive in this respect.

Maintenance work and repairs may only be carried out by authorised Winterhalter service technicians. Improper maintenance or repairs may cause significant danger to the user, for which Winterhalter is not liable.

3 Machine description

3.1 Description of function

The CTR is a warewasher with automatic rack conveyor. For this, the wash rack is moved with the help of the push bars through the various zones. The working direction can be either from left to right or from right to left. The detergent for the main wash zone and rinse aid for the rinse zone are automatically added with the help of external and optional dosing devices. The CTR can be expanded by a pre-wash zone, a drying zone and an energy module.

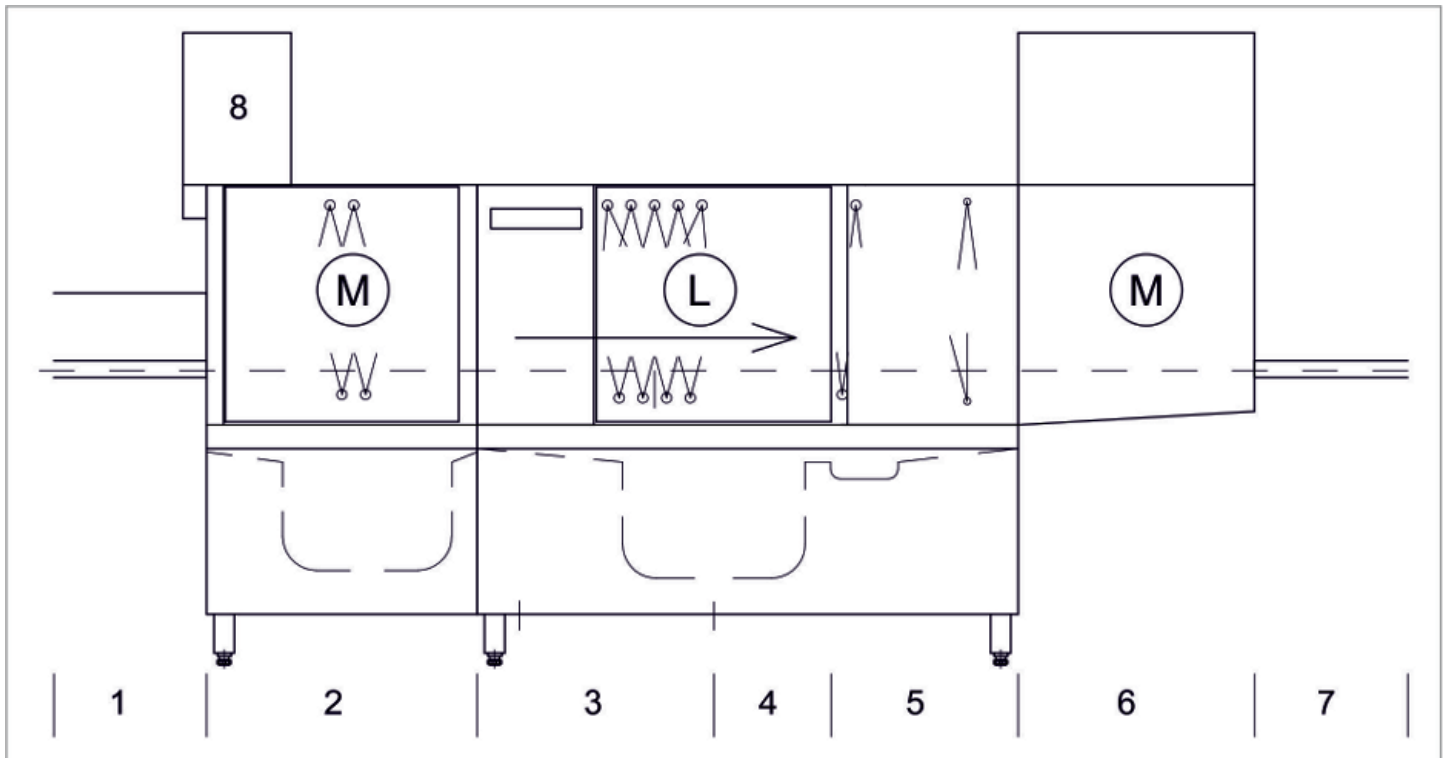

Figure: CTR ML-M with energy module

Item	Name	Alternative
1	Inlet table (straight or around the corner)	Corner conveyor
2	Pre-wash zone M	Pre-wash zone S
3	Main wash zone	
4	Drip section	
5	Rinse zone with dual rinse	Single rinse
6	Straight drying zone M	Corner drying zone M with corner conveyor
7	Outlet roller table	Corner conveyor
8	Energy module	
3-5	CTR L	CTR M

3.2 Overview

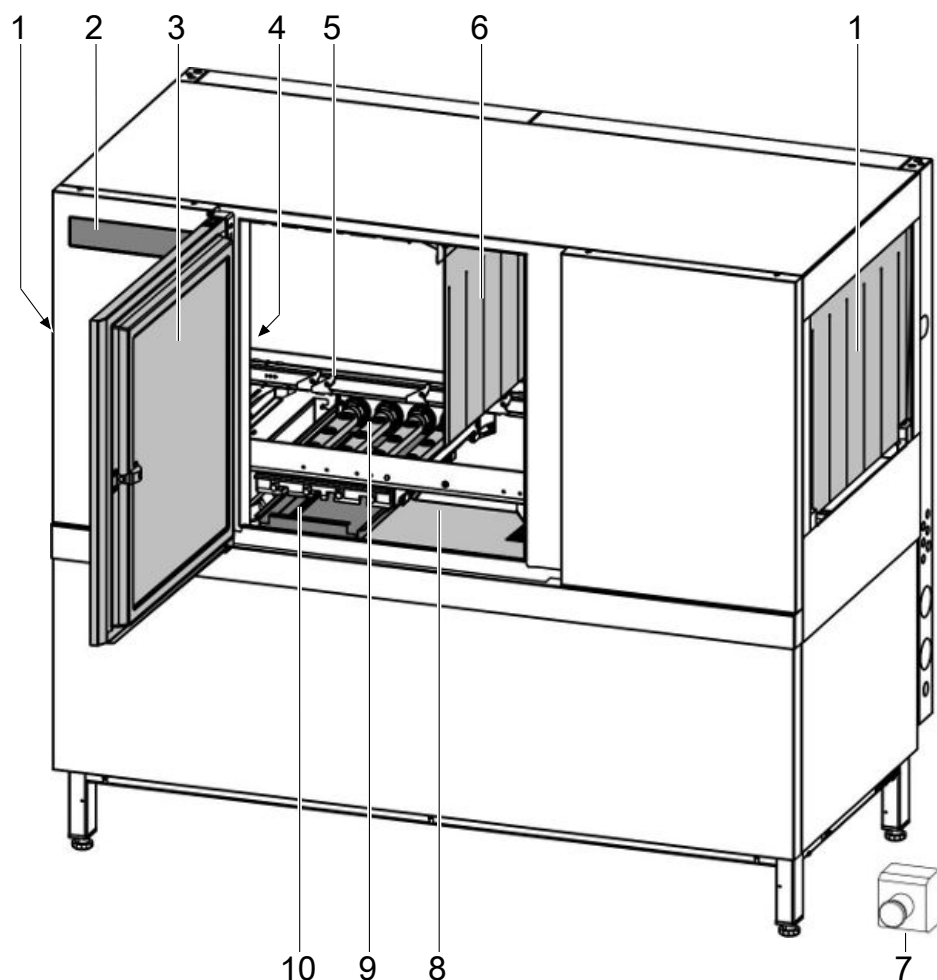

Figure: CTR M with single rinse and working direction "left to right"

Item	Name	Item	Name
1	Long curtain (length: 520 mm)	6	Short curtain (length: 445 mm)
2	Display	7	Emergency stop switch (optional)
3	Door	8	Strainer
4	Rack bracket	9	Wash arms (top: 5; bottom: 4)
5	Rack conveyor with push bars	10	Filter cassette

Warewashers with dual rinse additionally have a strainer and two wash arms in the rinse zone.

Pre-wash zones (optional)

The pre-wash zones are used for scraping the wash items.

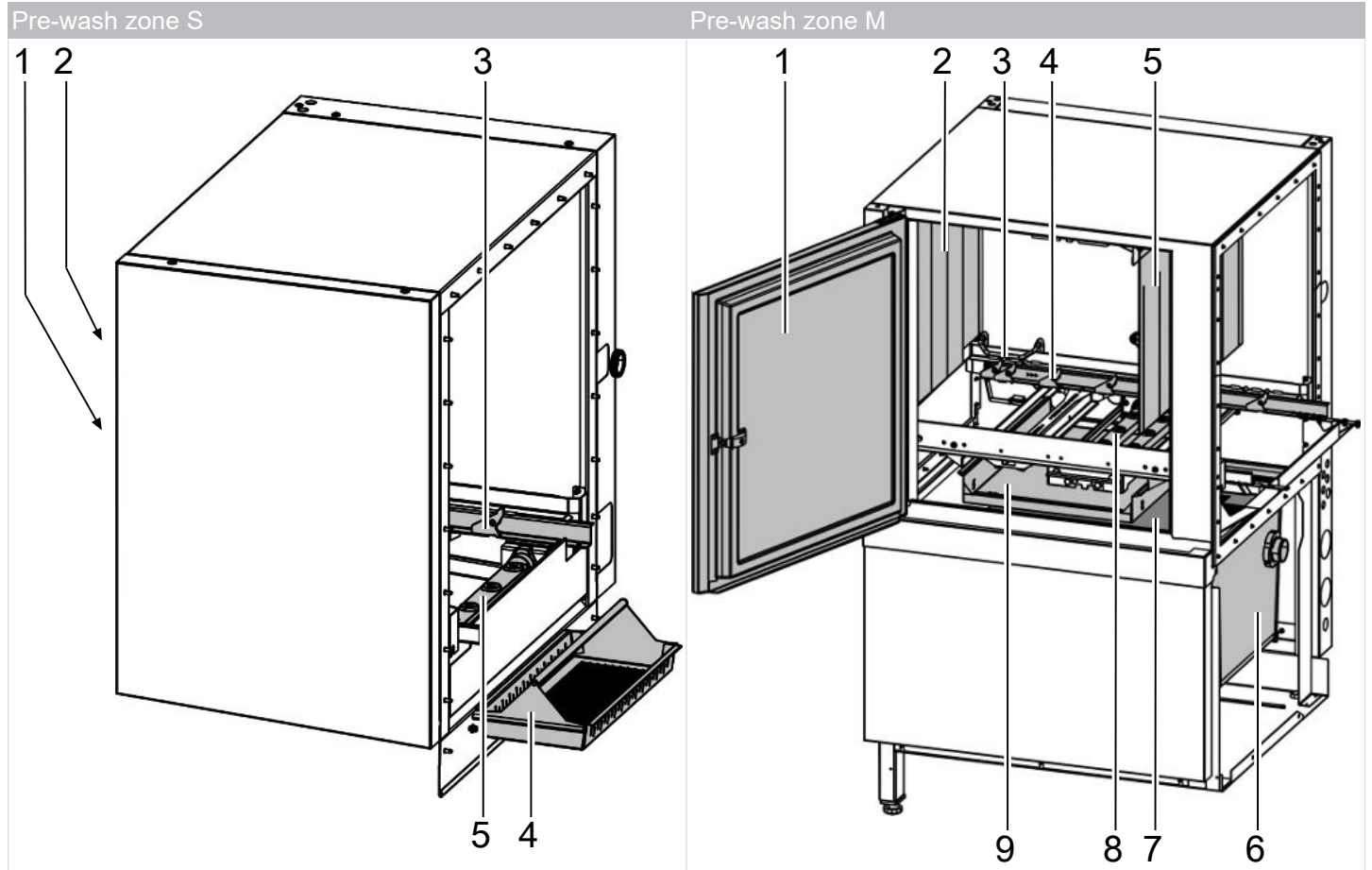

Item	Name	Item	Name
1	Rack bracket	1	Door
2	Long curtain (length: 520 mm)	2	Long curtain (length: 520 mm)
3	Rack conveyor with push bars	3	Rack bracket
4	Filter cassette	4	Rack conveyor with push bars
5	Wash arms (top: 1; bottom: 1)	5	Short curtain (length: 445 mm)
		6	Tank
		7	Strainer
		8	Wash arms (top: 2; bottom: 2)
		9	Filter cassette

Energy modules (optional)

The energy module extracts the moist, warm air (vapours) emitted from the warewasher and directs it through a heat exchanger.

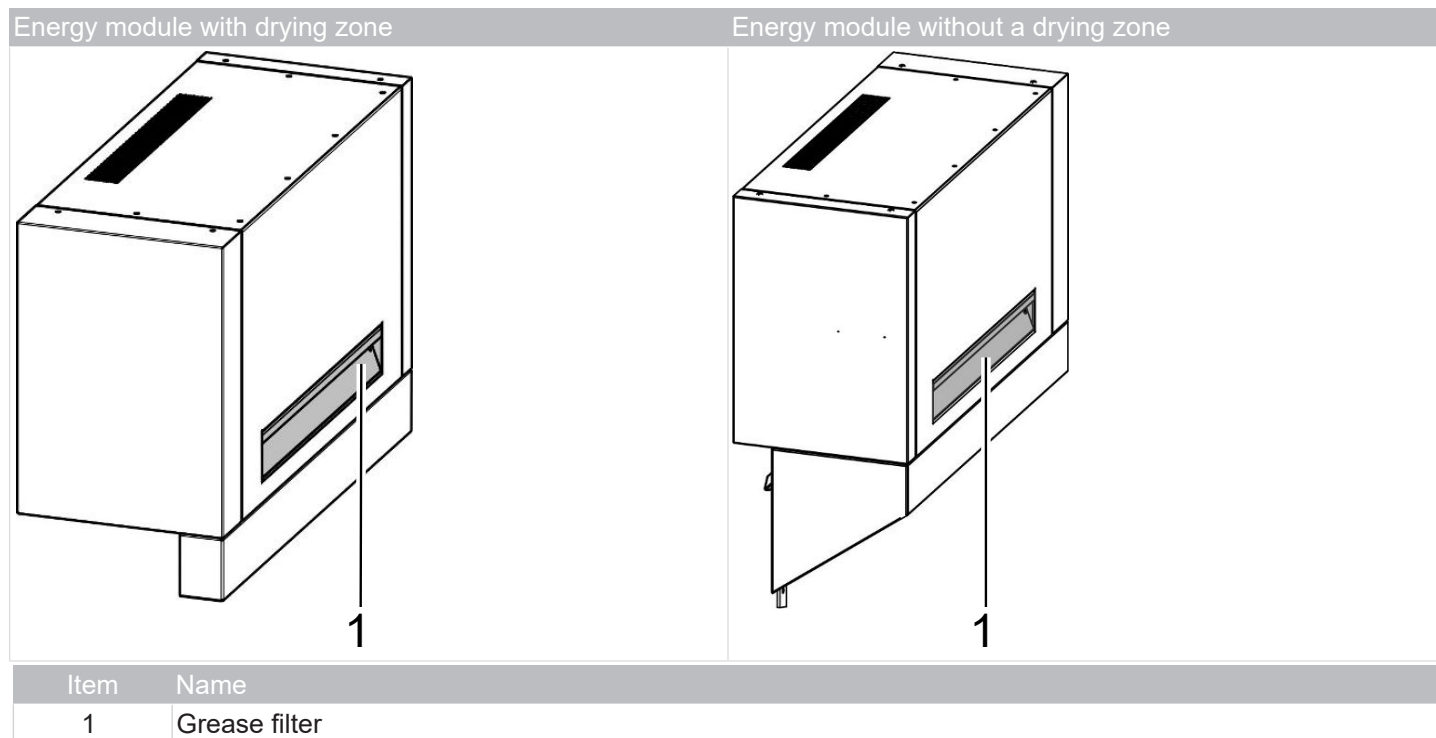

Emergency stop switch (optional)

Pressing the emergency stop switch stops the rack conveyor and switches off the warewasher. This does not mean the warewasher is disconnected from the electrical supply.

The position of the emergency stop switch must be determined individually on-site following an analysis of any possible hazard potential.

3.3 Display

Operating the display is similar to operating the display of a smartphone. The display responds to light touches. Therefore, operate the display only with your fingers; do not use any sharp objects. The display and start button can also be operated with wet hands or rubber gloves.

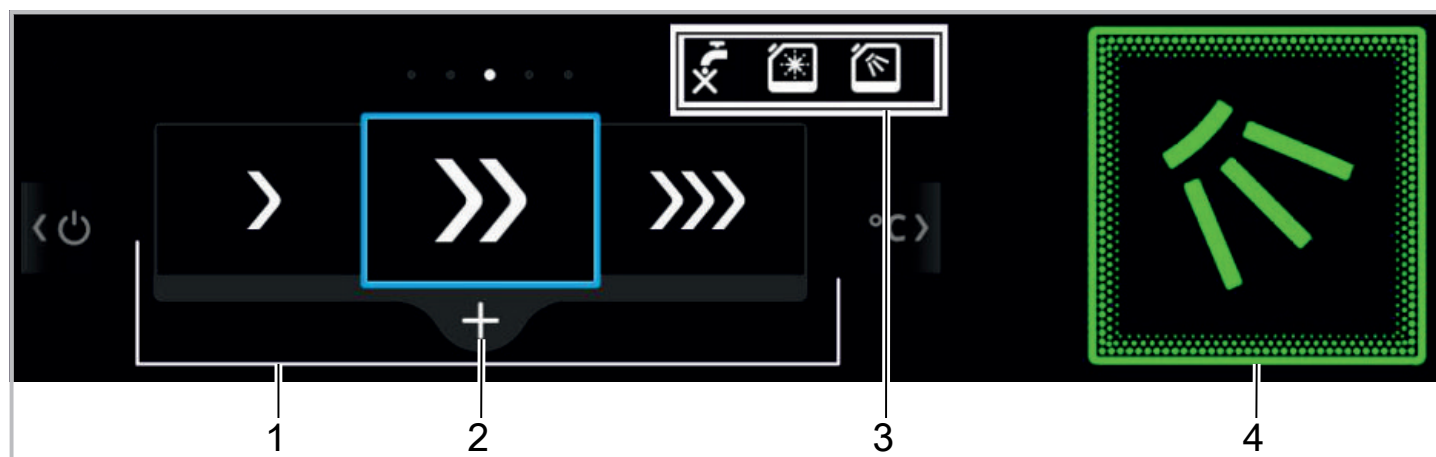

Item	Name	Item	Name
1	Transport speeds	3	Display area of messages
2	Selecting a different wash mode	4	Start button

Screen saver

If the display is not used for a long time, the selected transport speed will appear and fill the display.

Working direction display

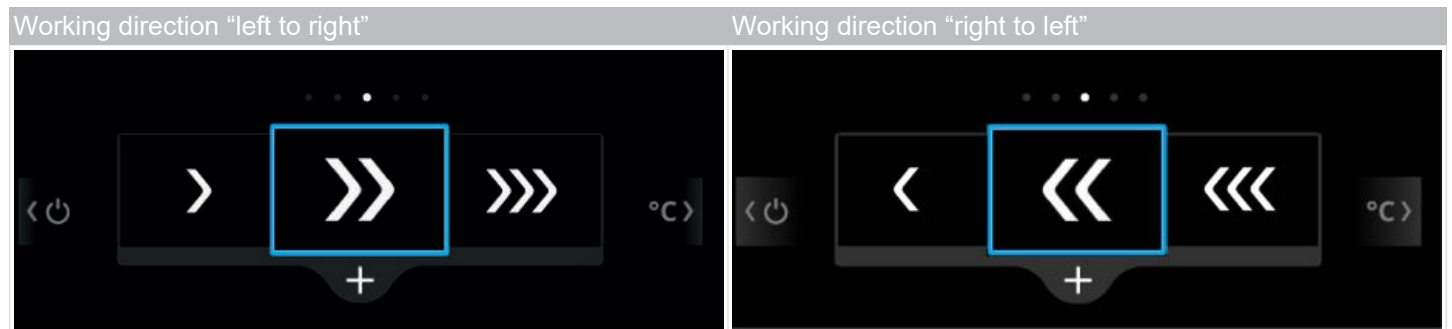

Start button (4)

The colours have the following meanings:

Colour	Meaning
Not lit	Warewasher is switched off.
Orange	Warewasher is filling and heating up.
Green	Warewasher is ready for use.
Blue	Warewasher is washing or rack conveyor is active.
Red	The warewasher no longer washes because there is a serious error.

Transport speeds (1)

The following transport speeds are available:





Transport speed	Soiling of the dishes	
>	Low	Severe
>>	Medium	Normal
>>>	High	Light

The transport speed Medium is pre-selected (blue frame) as soon the warewasher is ready.

3.4 Wash modes

The service technician sets the wash mode of the warewasher at commissioning. In addition, he also sets the alternatively selectable wash modes.

The following wash modes are available:

Wash mode	Meaning
 Hygiene	The transport speed decreases if the tank and/or boiler temperature drops. This enables the target temperature to be reached again after a certain time. The transport speed then increases again.
 Speed	The transport speed stays constant even if the tank and / or boiler temperature drops.
 HighTemp	Wash in Hygiene mode but with a higher tank temperature.
 Containers	Only for warewashers with dual rinse: The first line of dual rinse is switched off. This extends the drip section between the main and rinse zones for long wash items (e.g. trays) and improves the rinse result. The "Containers" wash mode is only available as an alternative wash mode.

The wash mode can be changed during the washing process. (► 34).

See also

 Washing [► 32]

3.5 Info display

➤ Access the following menu:

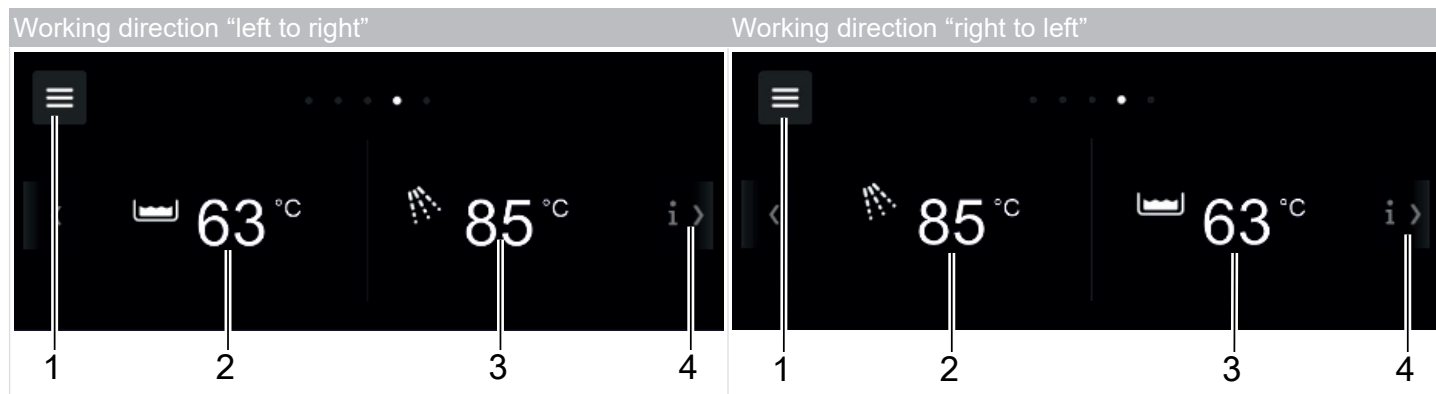

Item	Name	Item	Name
1	Access to the dishwashing staff menu / chef menu	1	Access to the dishwashing staff menu / chef menu
2	Current tank temperature	2	Current rinse temperature
3	Current rinse temperature	3	Current tank temperature
4	Switch to the next info display	4	Switch to the next info display



Item	Name
1	Access to the dishwashing staff menu / chef menu
5	Machine number
6	Date / time
7	CONNECTED WASH (optional): The warewasher is connected to the Internet
8	Phone numbers for maintenance and washing chemical suppliers
9	Machine model

3.6 Rinse aid and detergent



Caution

Risk of chemical burns when handling chemicals

Contact with chemicals can occur when changing the container.

- Observe the danger and safety notes on the container and safety data sheet.
- Wear protective clothing, protective gloves and protective goggles.

Use only products that are suitable for commercial warewashers. We recommend using Winterhalter products that are especially adapted to Winterhalter warewashers. The correct dosage is based on the information on the product packaging. A transfer strip is available for connecting external dosing devices (▶ 30).

Rinse aid

Rinse aid is necessary to ensure that water on the items being washed drains off after washing as a thin film. This ensures that the wash items dry quickly.

Rinse aid is automatically dispensed using an external dosing device.

Detergent

A detergent is necessary to dissolve the leftovers and dirt on the wash items. Detergent is automatically dispensed using an external dosing device.

To avoid damaging the warewasher and to achieve a good wash result:

- Do not use acidic detergents.
- Do not use foaming product (e.g., manual washing-up liquid) for pre-treating the wash items.

See also

- 📄 Connecting external dosing devices [▶ 29]

3.7 Suction tube with level control

A suction tube is needed to suck out the chemicals from the containers.

- Do not place the suction tube for the rinse aid in the container holding detergent defoamer, or vice versa.
- Use the suction tube only with sufficiently stable containers. Narrow and tall containers can tip as soon as the suction tube is pulled.
- Do not pull on the dosing hose or main power cable, as this may lead to a defect.



Colour (cap)	Container
Blue	Rinse aid
Grey	Detergent
Orange	Defoamer



Item	Name
1	Float switch for level control

The float switch (1) can detect a defect in the chemicals and indicates this on the display ▶ 41.

See also

- 📖 Replace the container [▶ 41]

3.8 Technical data

Temperature default setting

Zone	Temperature
Pre-wash zone S	63 °C
Pre-wash zone M	45 °C
Main wash zone	63 °C
Rinse zone (with single rinse)	85 °C
Rinse zone (with dual rinse)	65 / 85 °C

Programme / wash zone	Temperature
Drying zone	60 °C
Basic cleaning programme	69 °C
HighTemp	73 °C

Noise emission

Measured value	Noise level
Measurement uncertainty K_{pA}	2.5 dB
Workplace-related emission sound pressure level L_{pA}	< 70 dB

Exhaust air

Observe the VDI guideline 2052 constructing the ventilation system.

4 Software

4.1 Chef menu

In this menu the chef can change settings to the warewasher and access information. The warewasher switches off when the menu is accessed. After leaving the menu, the warewasher must be switched back on.

Access the chef menu

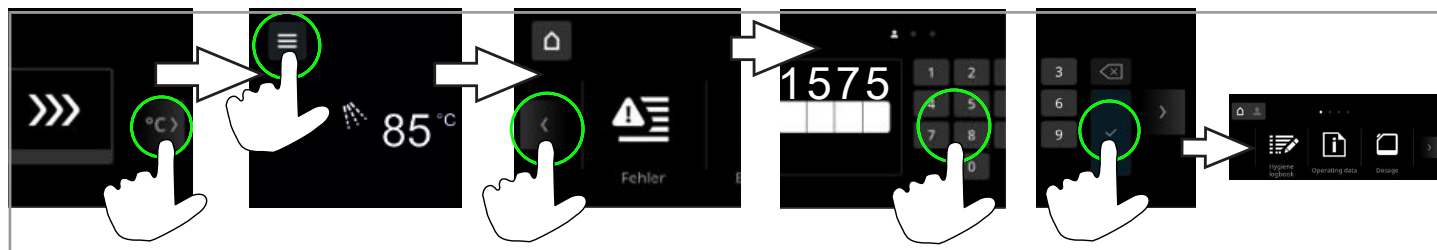

A PIN protects the menu from unauthorised access. The PIN is 1575. If you enter your PIN incorrectly three times in a row, input will be blocked for 10 minutes.

Navigation

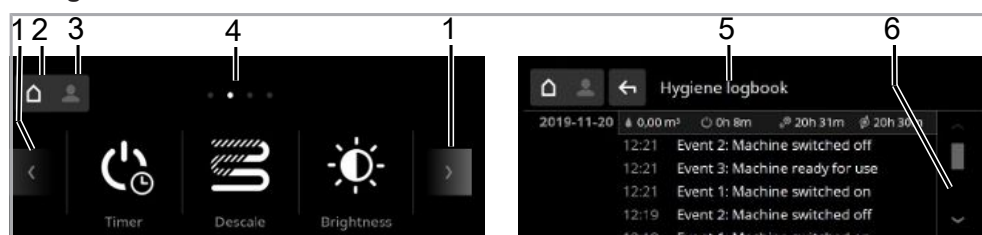

Item	Name
1	Continue to the next window by tapping or swiping
2	Exit the menu
3	“Chef menu” symbol
4	Number of windows at the same level
5	One level back
6	Scroll up or down

The following menus are available:

Menu	Menu
Hygiene logbook	Sounds
Operating data	Date / time
Dosage	Language
Timer	Units
Descal	CONNECTED WASH
Brightness	Water back-flow counter

The number of menus depends on the configuration of the warewasher.

4.1.1 Hygiene logbook

In this menu the daily operating states are shown in chronological order. The list begins with the summary of daily operating data.

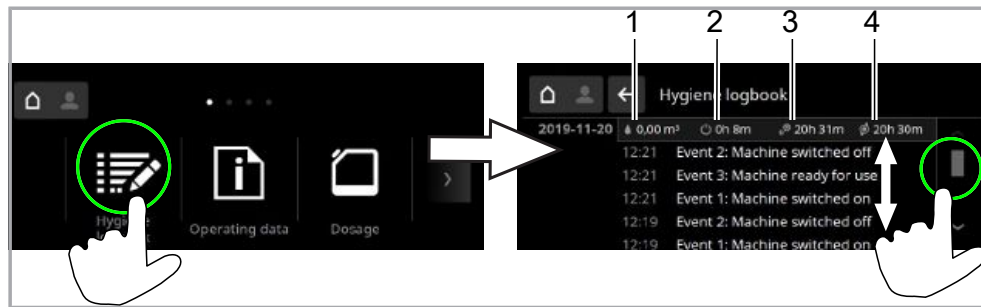

Item	Name
1	Water consumption (m³)
2	Switch-on time in hours and minutes
3	Switch-on time of the basket drive in hours and minutes
4	Switch-on time of the wash pump in hours and minutes

4.1.2 Operating data

In this menu the operating data, e.g. consumptions and operating hours, are shown. Water consumptions are reference values and are not based on precise measurements.

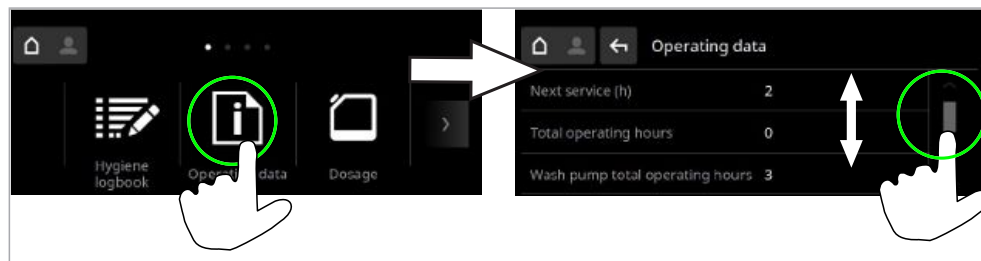

4.1.3 Dosage

In this menu the detergent and rinse aid dosing device are set.

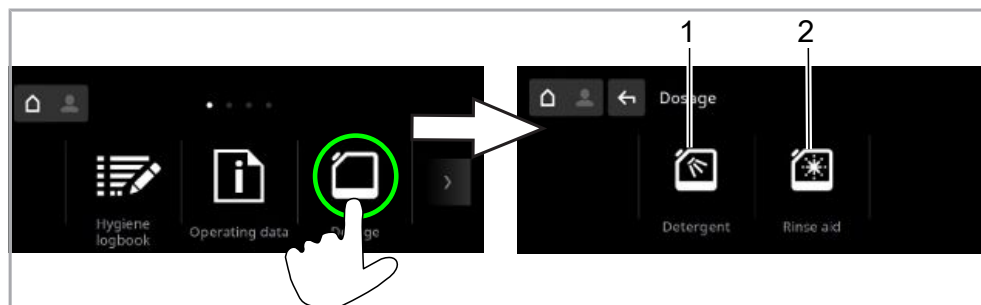

Item	Name
1	Detergent dosing device
2	Rinse aid dosing device

Set the detergent dosing amount

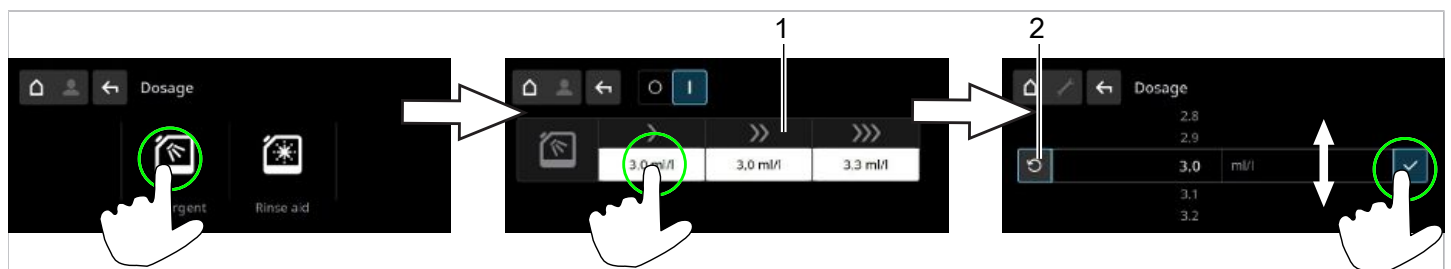

Item	Name
1	Transport speed
2	Reset to default setting

Set the rinse aid dosing amount

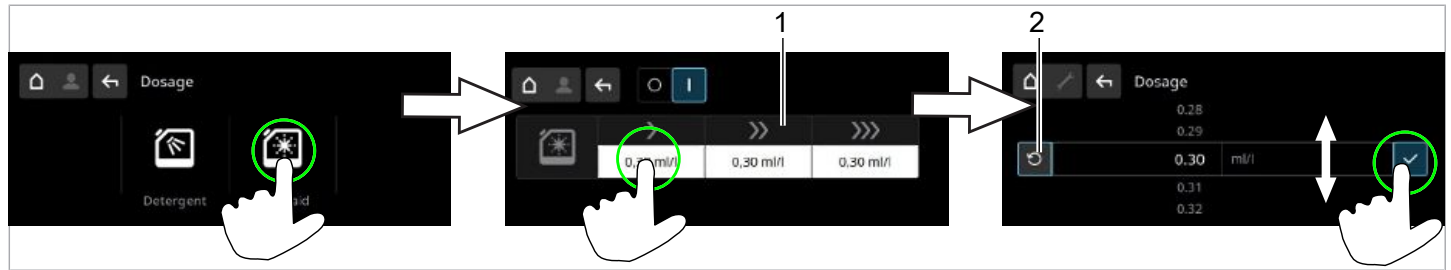

Item	Name
1	Transport speed
2	Reset to default setting

Configure an external detergent dosing device connection

The service technician requires this menu when he connects an external detergent dosing device to the ware-washer. ▶ 30

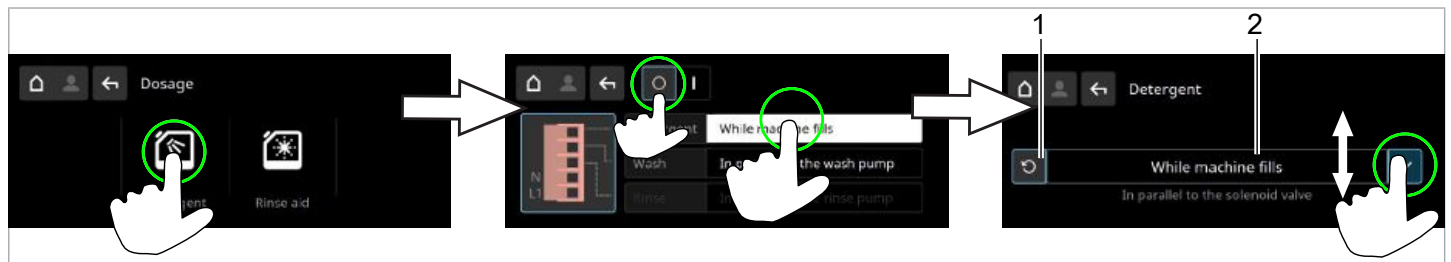

Item	Name
1	Reset to default setting
2	Voltage at the "Detergent" terminal <ul style="list-style-type: none"> – while the warewasher is filling up – parallel to the solenoid valve

Configure an external rinse aid dosing device connection

The service technician requires this menu when he connects an external rinse aid dosing device to the ware-washer. ▶ 30



Item	Name
1	Reset to default setting
2	Voltage at the "Rinse" terminal <ul style="list-style-type: none"> – parallel to the rinse pump – parallel to the solenoid valve

See also

📖 Connecting external dosing devices [▶ 29]

4.1.4 Timer

The timer can programme the warewasher to switch on or off automatically at a specific time. At the time of automatic start-up the following requirements must be met:

- The door is closed.
- The on-site mains isolation switch is switched on.
- The on-site water supply is open.



Item	Name
1	Regularly
2	Non-recurring date

Programme a regular time

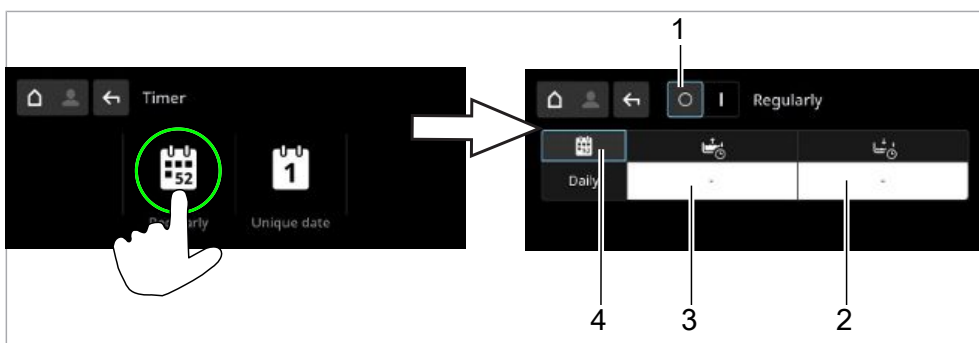

Item	Name
1	Switch the timer off / on
2	Time for automatic switch-off
3	Time for automatic start-up
4	Select time schedule <ul style="list-style-type: none"> - Daily - Mon-Fri, Sat-Sun - Individual (a different time on every weekday)

Programme a non-recurring date

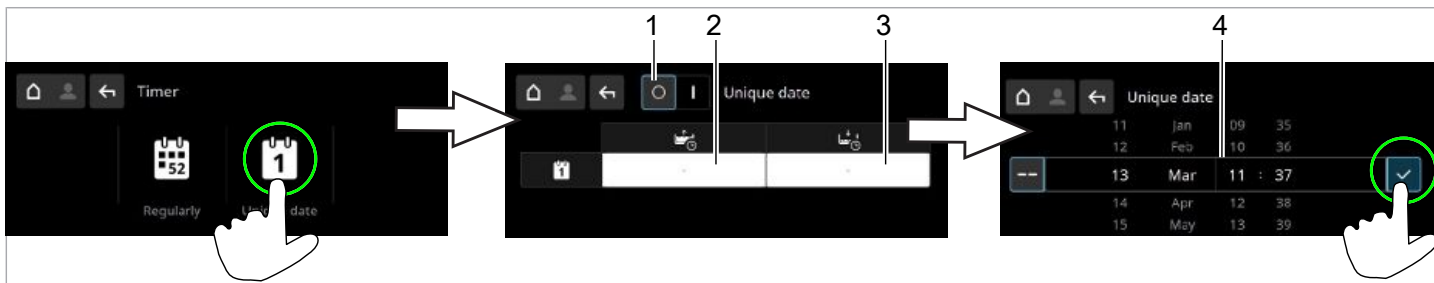

Item	Name
1	Switch the timer off / on
2	Date and time for automatic start-up
3	Date and time for automatic switch-off
4	Date and time

Automatic switch-off sequence

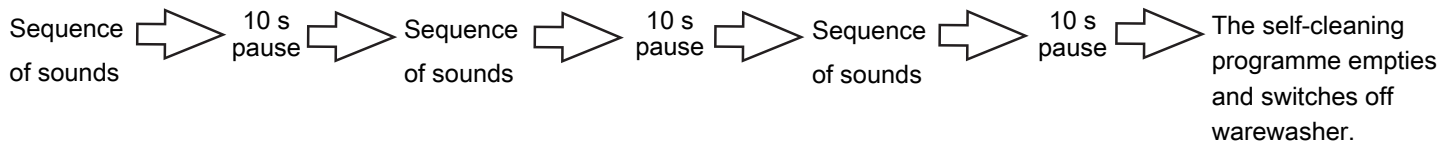

If the door is open during the automatic switch-off, the warewasher is pumped empty and switched off.

Show time programme

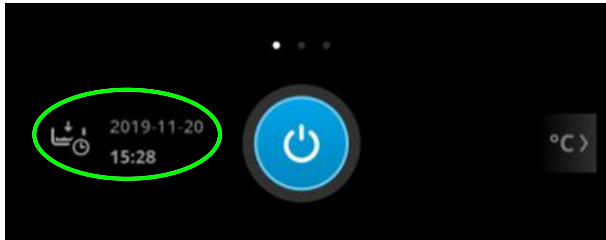

4.1.5 Descale

If the warewasher is operated with hard water and without water treatment, then the boiler, the interior of the machine, all the water lines and other components may develop scale. Grease residues and dirt that remain in the machine can contribute towards hygiene risks, while scaling can lead to failure of heating elements. Regular removal of these coatings is recommended.

Using the descaling programme, you can descale the interior of the warewasher. The water lines and the boiler can be descaled only by an authorised service technician.

For descaling, you need an acid-based descaler suitable for commercial warewashers. We recommend the Winterhalter Descaler A 70 LS.

Ideally, start the descaling programme when the warewasher is empty and switched off. If the warewasher is already prepared for use, it will automatically empty first.



Warning

Risk of chemical burn due to contact with descaler

Contact between descaler and the skin or eyes can lead to severe burns or serious eye damage.

- Wear protective clothing, protective gloves and protective goggles.
- Observe the danger and safety notes on the container and safety data sheet.



Warning

Danger of chlorine gas developing

Mixing active chlorine cleaner and acid-based descaler produces chlorine gas. Contact with chlorine gas leads to eye, nose and throat irritations.

- Do not mix active chlorine cleaner and acid-based descaler.
- Ensure good ventilation when you descale the warewasher.

Start the descaling programme

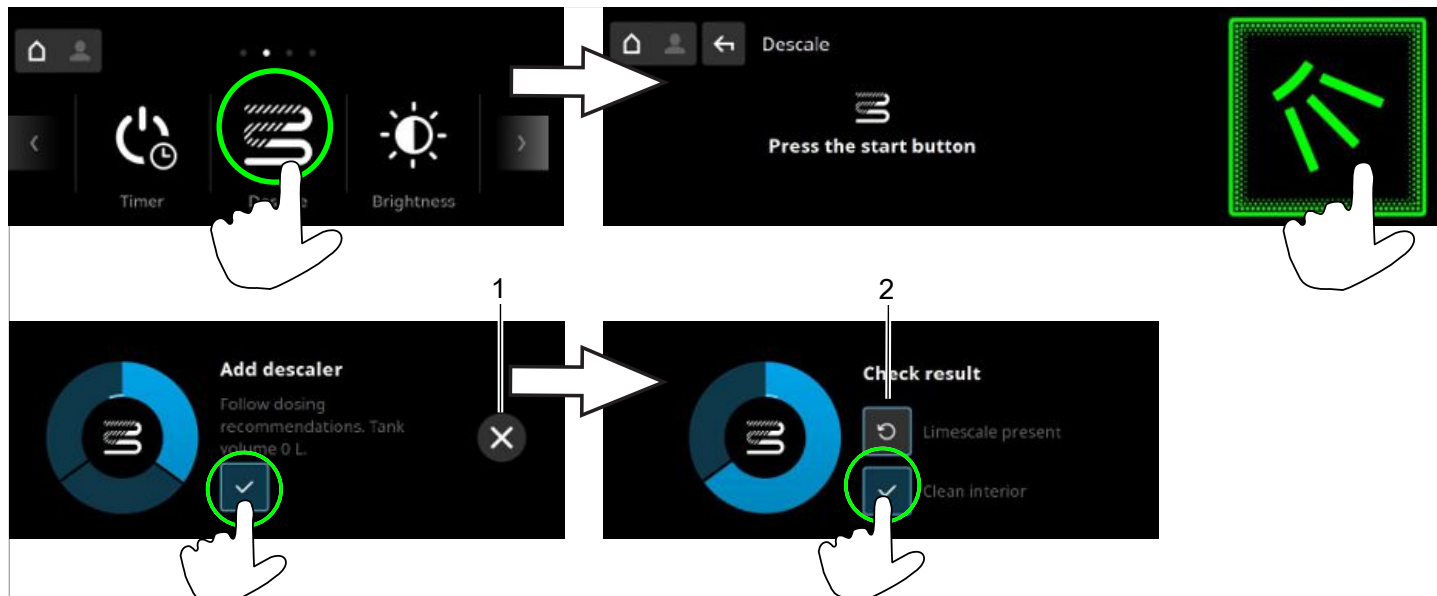

Item	Name
1	Terminate descaling programme (possible as long as no descaler has been added)
2	Repeat descaling programme

For warewashers with pre-wash zone M: Add descaler to both tanks.

When adding the descaler, observe the following tank volumes:

- Tank volume of pre-wash zone M: 53 l
- Tank volume of main wash zone: 80 l



Note

Danger of corrosion due to descaler solution

Descaler solution has a corrosive effect when in contact with metals and plastics for a long time and therefore must not remain in the interior of the machine (e.g. overnight).

- Do not terminate the descaling programme and follow the instructions on the display.

4.1.6 Brightness

In this menu the brightness of the display is set.

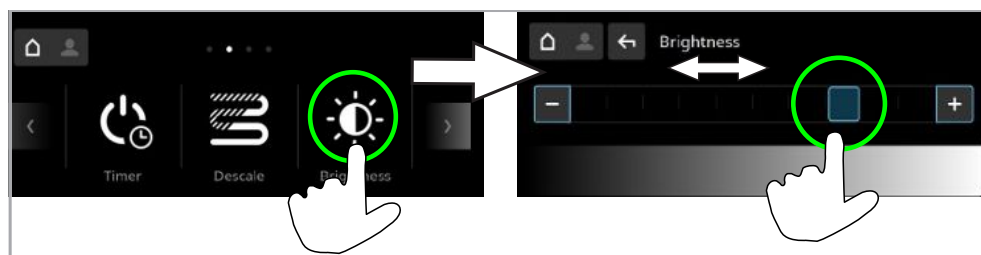

4.1.7 Sounds

In this menu sounds are turned on or off.

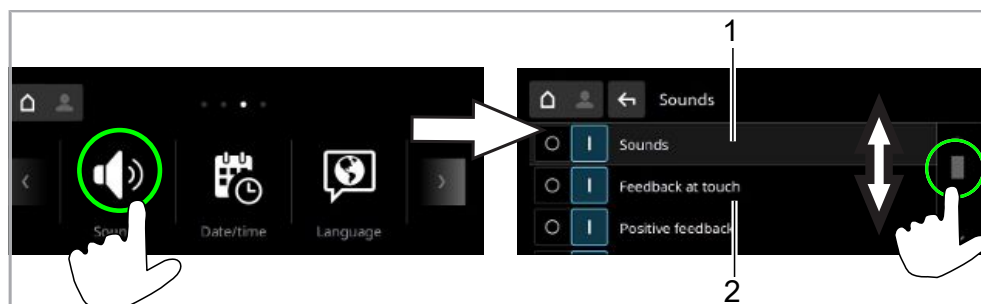

Item	Name
1	Turn all sounds on or off
2	Turn individual sounds on or off

4.1.8 Date / time

In this menu the date and time are entered.

Note: Time must be changed for the summer/ winter time changeover.

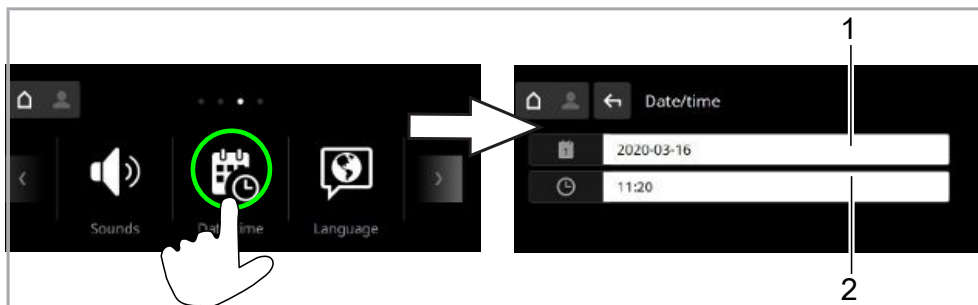

Item	Name
1	Date
2	Time of day

4.1.9 Language

In this menu the language of the display texts is set.

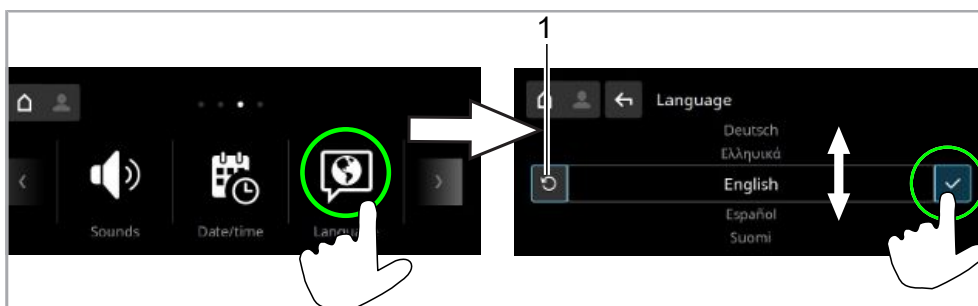

Item	Name
1	Reset to last language set

4.1.10 Units

In this menu the unit and temperature indicator are changed.

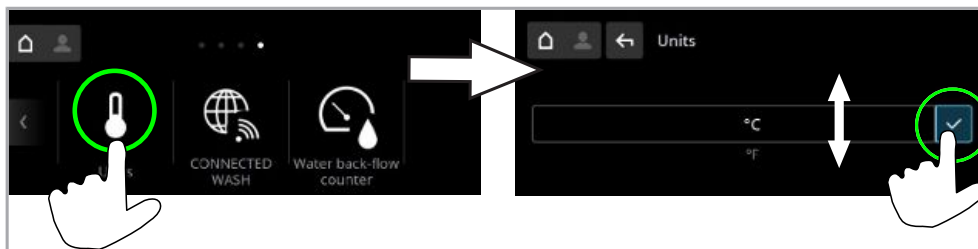

4.1.11 CONNECTED WASH

In this menu the link with CONNECTED WASH is configured.

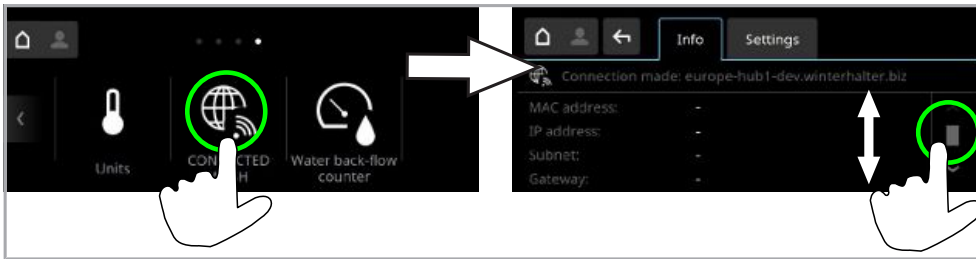

Activating CONNECTED WASH

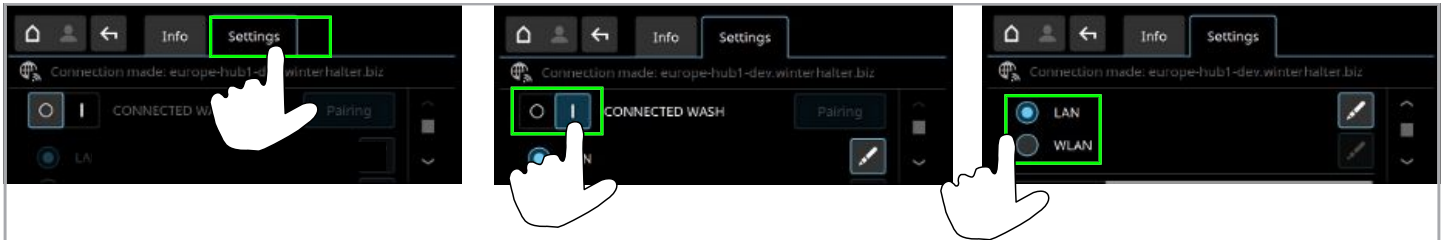

You will find detailed information and instructions on the following website:

<http://www.connected-wash.biz/start/de/>

4.1.12 Water back-flow counter

The water back-flow counter must be reset if the set total capacity of an external water treatment device has reached the value "0".

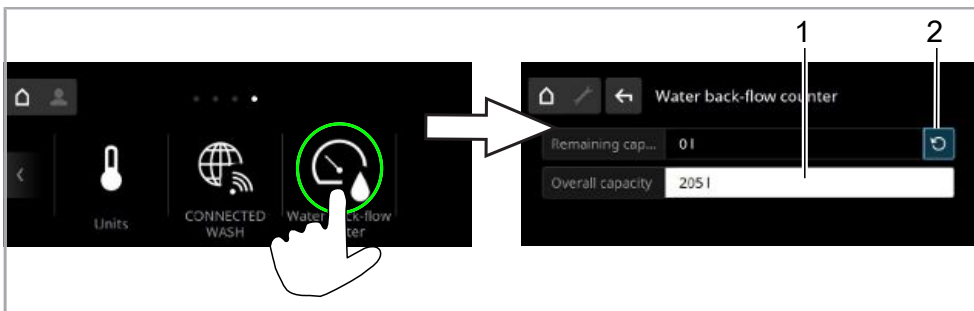

Item	Name
1	Set the total capacity
2	Reset the water back-flow counter

5 Commissioning

5.1 Installing the warewasher

The installation site must be frost-resistant to prevent the water supply systems from freezing.

- Install the warewasher horizontally using a spirit level.
- Adjust any unevenness of the base using the height-adjustable machine feet.

5.2 Connecting the warewasher

The warewasher and any other relevant additional devices must be connected in adherence to local standards and regulations by an electrical company authorised by the relevant electricity supplier.

5.2.1 Water connection

The water-related safety should be as per DIN EN 61770. The warewasher can be connected to a fresh water pipe without an intermediate connection to other safety equipment.

Connecting the inlet water hose

Important notes:

- Do not shorten or damage the inlet water hose.
- Use only the inlet water hose supplied. Old existing inlet water hoses may not be re-used.
- Do not kink the inlet water hose when laying it.

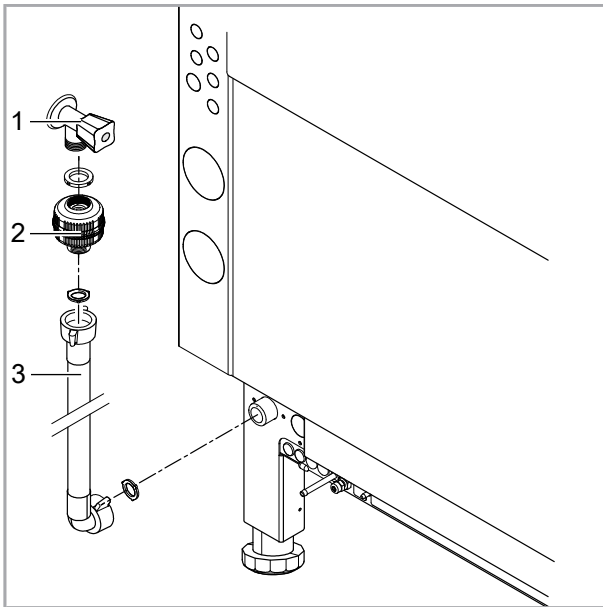

- Connect the inlet water hose (3) to the warewasher.
- Connect the dirt trap (2) to the on-site water supply (1).
- Connect the supply hose (3) to the dirt trap (2).
- Open the water supply (1) and check that the connections are sealed.

The dirt trap prevents particles from the water supply line from entering the warewasher, thus preventing extraneous rust on the cutlery and in the warewasher.

Requirements for on-site installation

Location	Left, beside the warewasher
Construction	Isolation valve with G ¾" external thread
Inlet water temperature	10 – 60 °C CTR energy: 10 – 20 °C
Water quality	The microbiological aspects of fresh water must have the same quality as that of drinking water
Water hardness	Total hardness ≤ 3 °dH (3.8 °e / 5.34 °TH / 0.54 mmol/l) Recommended, so that the warewasher does not scale up.
Water flow pressure	150 – 600 kPa (1.5 – 6.0 bar)
Max. inlet pressure (back pressure)	600 kPa (6.0 bar)
Flow rate	8 – 15 l / min The flow rate influences the tank filling time

Connecting the warewasher to the waste water system

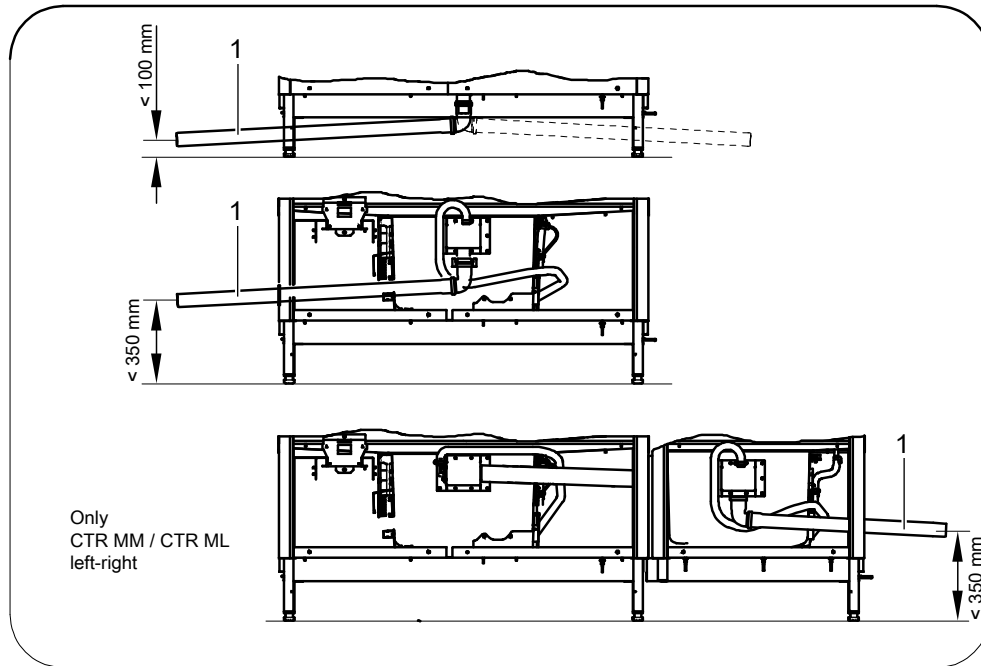

- Connect the waste water pipe (1) firmly to the warewasher.
- Guide and connect the waste water pipe with a slope (at least 3°) to the on-site waste water connection.

Requirements for on-site installation

Connection	Description
Location	Left or right of the warewasher depending on the machine variant <ul style="list-style-type: none"> – Max. 100 mm above finished floor – Max. 350 mm above finished floor when the waste water pipe is led out of the side of the warewasher. Retrofit kit 70014848 is required for this.
Construction	Min. \varnothing 70 mm with trap

5.2.2 Electrical connection



Danger

Electric shock from live components

A fatal electric shock can occur when the warewasher and its additional devices are connected to the electrical mains supply.

- The warewasher and its additional devices may be connected to the electrical mains supply only by a specialist company registered within the electrical trade and approved by the energy supplier.
- All locally applicable standards and regulations must be observed during the connection to the electrical mains supply.
- When performing installation and maintenance work as well as repairs, unplug the warewasher from the mains supply. Check that there is no voltage present.
- The electrical safety of this warewasher is guaranteed only if it is connected to a correctly installed protective circuit and a residual current circuit breaker. It is crucial that this basic safety requirement is tested and, in case of doubt, that the on-site installation is checked by a qualified electrician.
- The circuit diagram must be observed.
- The warewasher may be operated only at the voltages and frequencies specified on the rating plate.
- A mains isolation switch with all-pole separation from the mains supply must be installed in the electrical feeder and must be easily accessible. We recommend installing it near the warewasher.
- The electrical connection must be secured as a separately fused circuit with slow fuses or circuit breakers. The fuse protection depends on the total connected load of the warewasher. The total connected load is specified on the rating plate of the warewasher.
- If an on-site residual current circuit breaker is intended, we recommend installing a universal current-sensitive residual current circuit breaker of Class B with a release current of 30 mA (DIN VDE 0664), since a frequency inverter is located in the warewasher.
- Determine the cable cross section of the mains cable using the following table:

Voltage	Frequency [Hz]	On-site fuse protection [A]	Cable cross section [mm ²]
380 V – 415 V, 3N~	50, 60	50	10
		63	16
		80	25
230 V, 3~	50, 60	80	25
		100	35
		125	50
200 V, 3~	50, 60	100	35
		125	50
208 V, 3~	60	100	35
		125	50

The mains cable must be an oil-resistant, sheathed and flexible cable. The cable type H07RN-F is recommended.

Connecting the mains cable

- Disassemble the front cover and right-side cover.
- Disassemble the rear cover.
- Open the switchbox lid (1).
- Pull the earthing wire of the switchbox lid off the terminal strip (2).

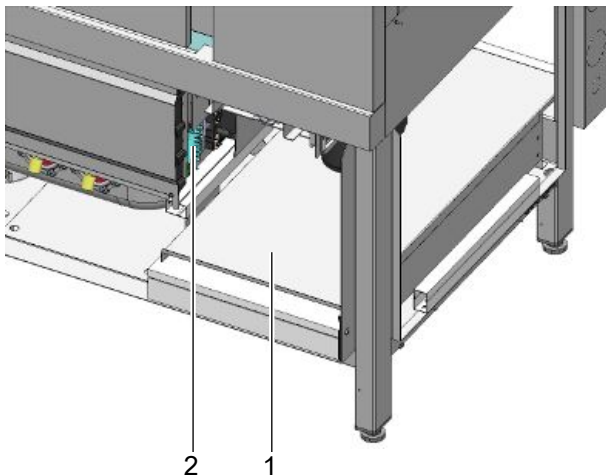

- Install the cable gland (4) in the corner cover or in the base plate according to the illustration.
- Guide the mains cable (3) through the cable gland (4) and tighten it.
- Strip the wire ends of the mains cable and attach ferrules.
- Connect the wires to the feeder terminals (5).
- Attach the strain relief (7).

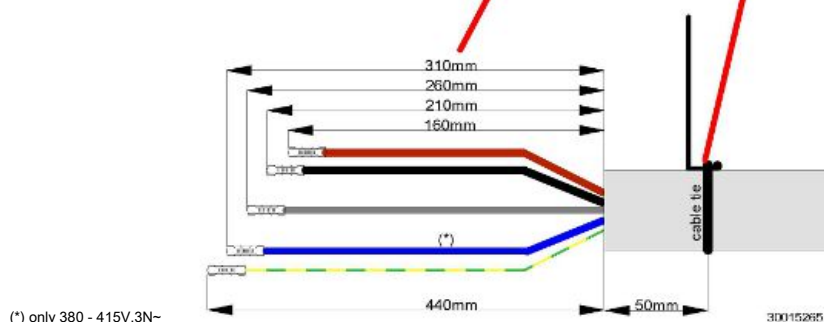
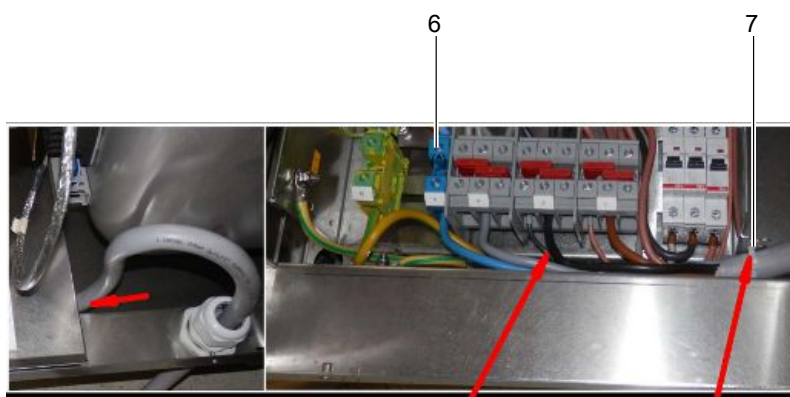
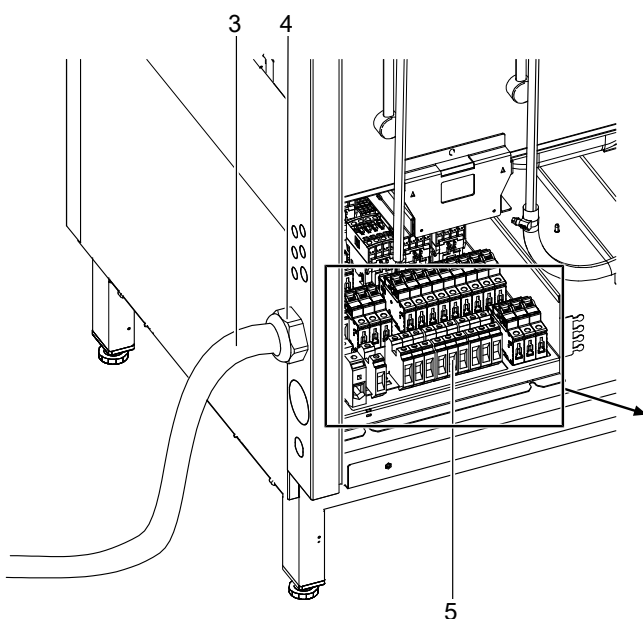

- Close the switchbox lid.
- Attach the earthing to the terminal strip.
- Assemble the rear cover.
- Assemble the front cover and right-side cover.

Note: In the case of a three-phase mains supply (230 V, 200 V, 208 V) without a neutral conductor (N), there is no blue neutral conductor terminal (6).

Establishing equipotential bonding

- Connect the warewasher to the on-site equipotential bonding system.
- Position of the connecting screw (1) see drawing.

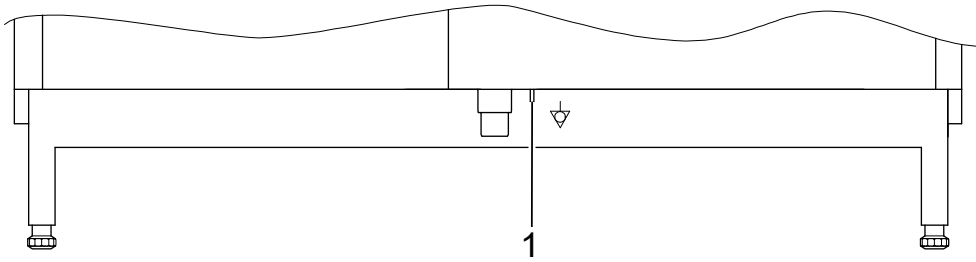

5.3 Connecting external dosing devices



Danger

Electric shock from live components

A fatal electric shock can occur when the warewasher and its additional devices are connected to the electrical mains supply.

- The warewasher and its additional devices may be connected to the electrical mains supply only by a specialist company registered within the electrical trade and approved by the energy supplier.
- All locally applicable standards and regulations must be observed during the connection to the electrical mains supply.
- When performing installation and maintenance work as well as repairs, unplug the warewasher from the mains supply. Check that there is no voltage present.

5.3.1 Terminals

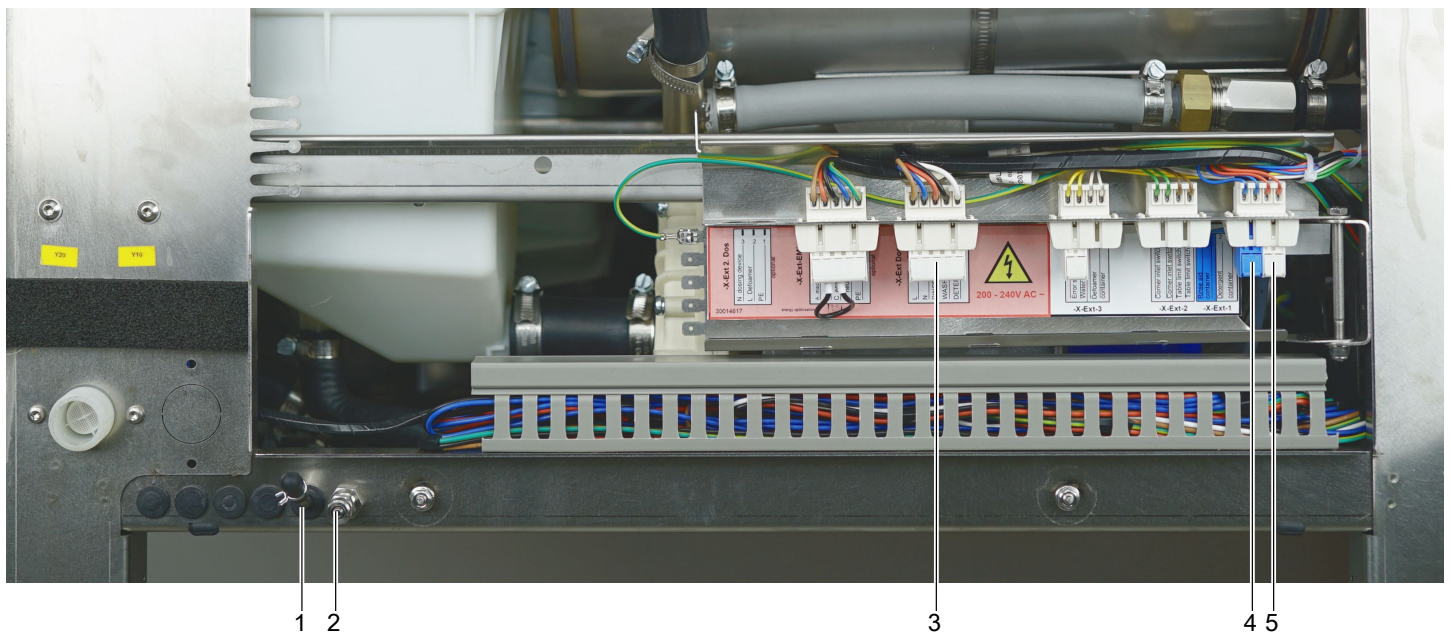

Item	Name
1	Connection for detergent
2	Connection for rinse aid
3	Connection for external dosing devices
4	Connection for suction tube rinse aid
5	Connection for suction tube detergent

5.3.2 Electrical connection

- Connect the external dosing device to the 5-pin plug.
- Configuring the transfer strip. ▶ 18

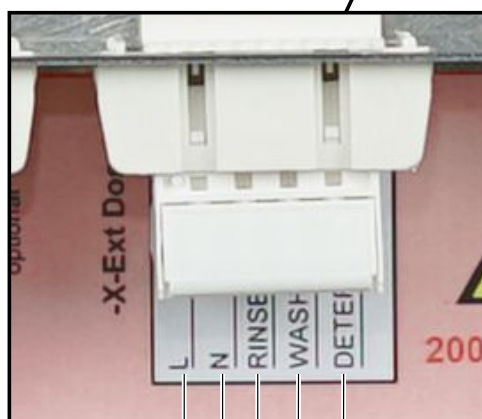
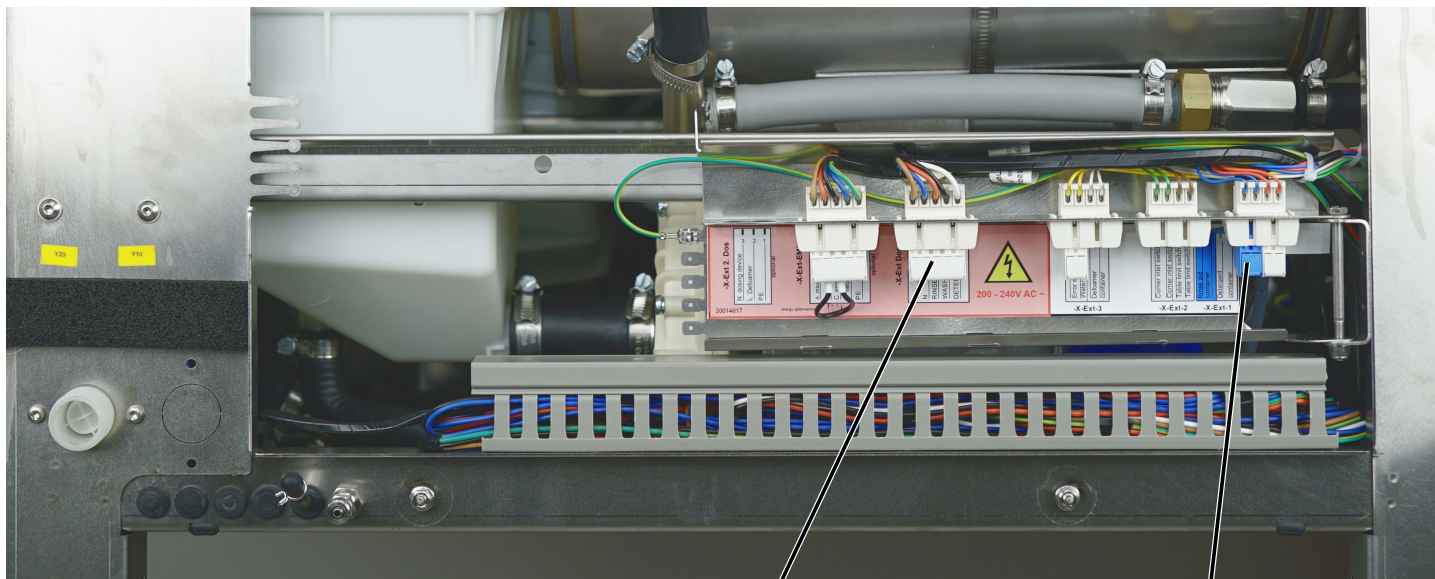

1 2 3 4 5



6 7

Item	Name	Item	Name
1	Continuous voltage L	5	DETERGENT terminal
2	N Terminal	6	Connection for suction tube rinse aid
3	RINSE terminal	7	Connection for suction tube detergent
4	WASH terminal		

See also

- 📄 Terminals [▶ 29]

5.4 Before working with the warewasher

- Have the warewasher set up by an authorised service technician or your dealer.
- Have the warewasher connected according to the locally applicable standards and the regulations by authorised mechanics (water, waste water, electrical system).
- After connecting the water and the power properly, contact the relevant Winterhalter dealer or your dealer for the commissioning of the warewasher and for providing training in its operation. Have yourself and your operating personnel trained in the operation of the warewasher.

5.5 Check for completeness

Check for completeness

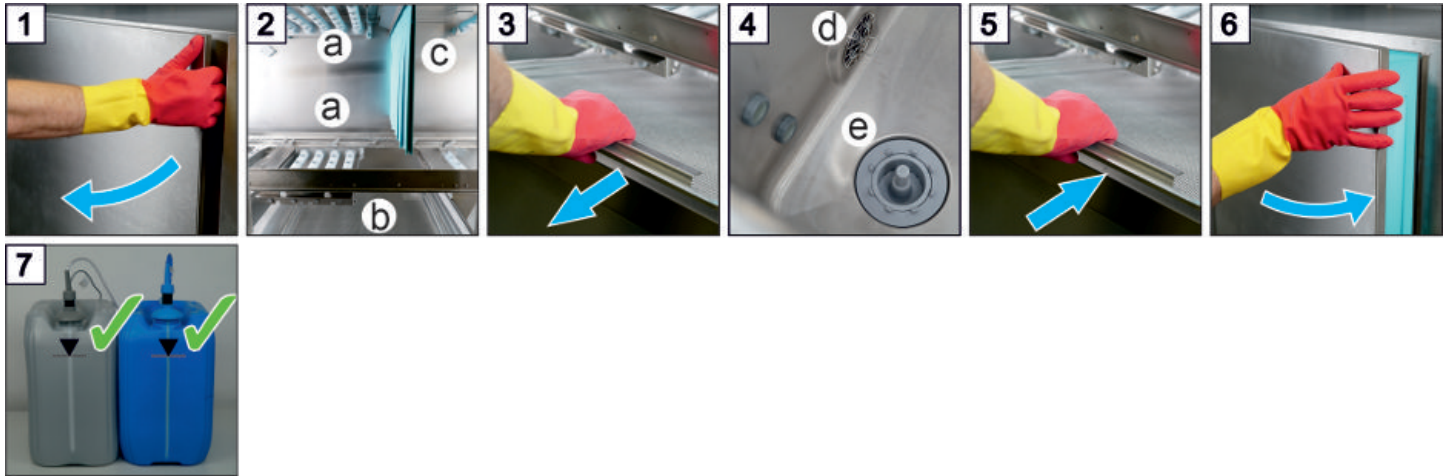

Item	Name	Item	Name
a	Wash arms	d	Pump inlet filter
b	Strainer	e	Drain filter
c	Curtain		

Note: Ensure that there is always enough detergent and rinse aid available to achieve an optimum wash result.

For warewashers with dual rinse:

- Check if the strainer and the wash arms have been installed. (► 9).

For warewashers with a pre-wash zone:

Check if the filters, curtains and wash arms have been installed (► 10).

See also

- 📄 Overview [► 9]

6 Operation

6.1 Switch on the warewasher

The warewasher is ready for operation as soon as the start button lights up green.

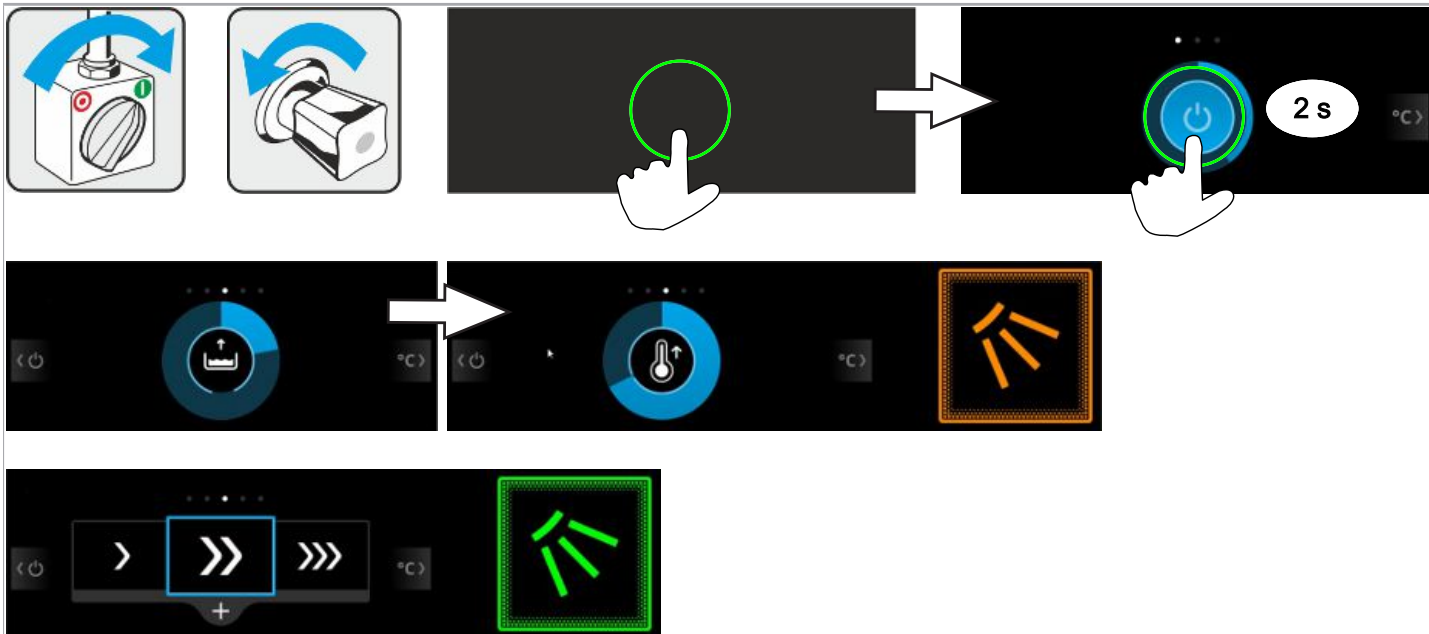

6.2 Washing



Caution

Risk of scalding from hot wash water

There is hot wash water in the interior of the warewasher after it is switched on.

- Do not open the door during the washing process.
- Do not reach through the curtains into the warewasher during the washing process.
- Before opening the door, terminate the washing process by pressing the start button and waiting a few seconds.



Warning

Risk of injury when loading the wash racks

- Be aware of sharp and pointed utensils when loading the wash racks.

- Do not wash electrical cooking appliances.
- Do not wash parts made of wood.
- Do not wash ashtrays and objects covered with wax.
- Only wash heat- and caustic-resistant plastic parts.
- Wash parts made of aluminium, e.g., pots, containers or trays, only with a specially suitable detergent to avoid black discolorations.
- Only wash containers with maximum dimensions of 530 x 325 mm.

Arranging the wash items in the wash rack

- Remove large leftovers.
- Pour out beverage residues (outside the warewasher).
- Place plates and trays with their upper surface facing forwards.
- Place glasses, cups, bowls and pots rim down.
- Wash cutlery preferably standing in the cutlery holder or lying in a shallow wash rack. Always arrange the end of handles downwards. Make sure that the cutlery is well spaced.

Instructions for a good wash result

- Do not overload racks, to allow the wash water to reach all dirty surfaces.
- Drench the cutlery until it is rinsed. Do not use any foaming pre-cleaners.
- Space the glasses to prevent them from rubbing against each other. This will avoid scratches.
- For tall glasses, choose a wash rack with appropriate divisions so that the glasses are held in a stable position.
- Do not polish glasses, cutlery and dishes. Germs and bacteria exist even in fresh multi-purpose cloths.
- Wash light objects in a washing cage so that they remain in a stable position. Alternatively, cover the wash rack with a second coarse mesh wash rack.

Start washing process

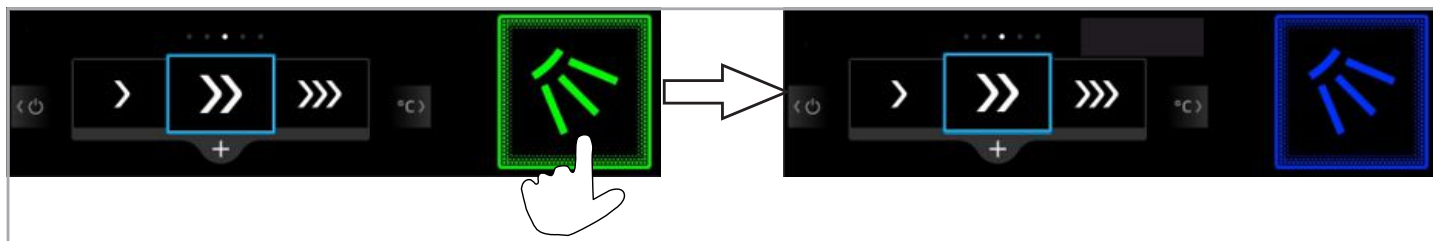

- All zones and the rack conveyor are switched on.
 - ⇒ Start button turns blue.
- Sort the wash rack correctly and push it into the warewasher.



Remove the wash racks from the outlet roller table

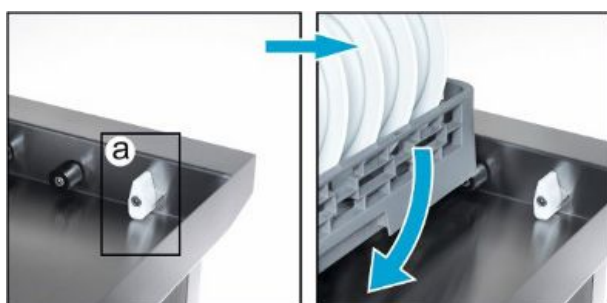

- Remove the wash rack from the outlet roller table before the table limit switch (a) is triggered. The table limit switch stops the rack conveyor and prevents the drive from being blocked if the wash racks are not removed from the outlet roller table.

Stop washing process

- Press start button.
 - ⇒ Start button turns green.

Select alternative wash mode



The alternative wash mode stays active until it is deactivated, another wash mode is selected, or the warewasher is switched off.

Deactivate alternative wash mode

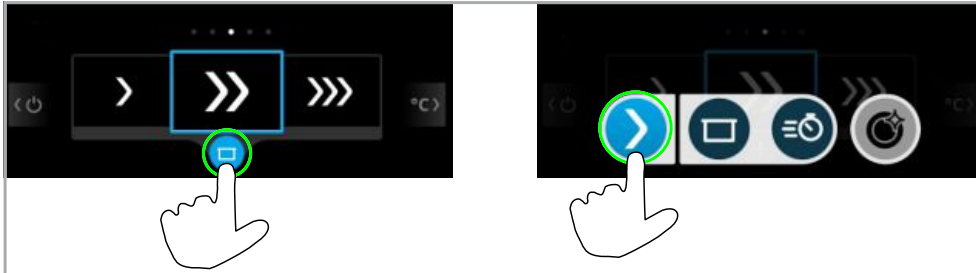

Wash breaks

- Do not switch the warewasher off during wash breaks.

6.3 Changing the tank water

Change the tank water if it is very dirty and if the end wash result worsens.

Note: It takes a few minutes until the warewasher is ready for operation again, as the tank is first emptied and then refilled and reheated.

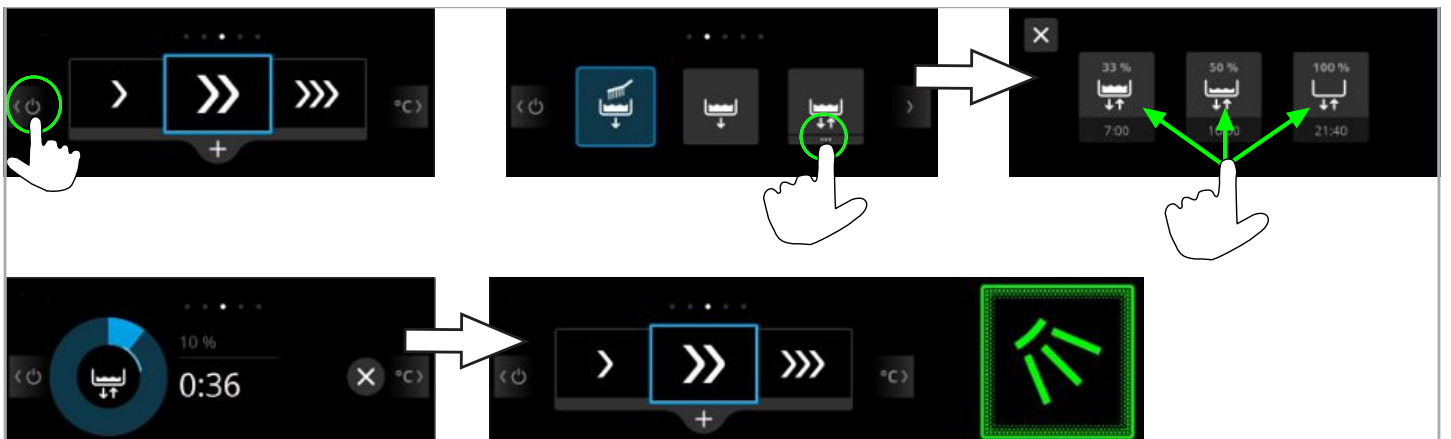















6.4 Switch off the warewasher

- Switch off the warewasher at the end of the working day using the drainage programme so that it is cleaned and emptied every day.

7 Notifications

7.1 Pictograms

Notifications are displayed as pictograms. If there are many notifications, washing will still be possible but the end wash result will be impaired. Please therefore rectify any notification as soon as possible. If you cannot rectify the notification, contact an authorised service technician.

Cause / meaning	Remedy
 Lack of rinse aid	
 Lack of detergent	
 Lack of defoamer	Replace the container. Vent the dosing device (▶ 41).
 Error on external water treatment device	Check the water treatment device.
 Door was opened at an inadmissible time (e.g. during the washing)	Close the door and press the start button.
 Lack of water	Open the water supply. Have the dirt trap cleaned by a service technician or have a new dirt trap installed. Have the solenoid valve repaired by an authorised service technician.
 Energy optimisation active	Wait until the on-site energy optimisation activates the warewasher.
 Service interval expired	Contact an authorised service technician.
 Water level in the main wash tank too low	
Strainer clogged	Remove, clean and re-insert the strainer.
Foam in the main wash tank	<ul style="list-style-type: none"> – Do not use manual washing-up liquid – Rinse off soiling that contains protein with cold water before the washing process – Check the tank temperature. If it is continuously under 50 °C, switch from speed mode to hygiene mode or contact an authorised service technician. – Add defoamer
Water entrainment	<ul style="list-style-type: none"> – Place plates and trays in the wash rack with their upper surface facing forwards. – Place glasses, cups, bowls and pots in the wash rack rim down.
 Check the scaling	Start the descaling programme. (▶ 21)
 Accumulation in the unloading area	Remove the wash racks. (▶ 33).
 Drive blocked	Open the door, remove the obstruction and press the start button.
 Tank overflow or on-site water drain blocked	Switch off the warewasher. Close the water supply. <ul style="list-style-type: none"> – Clean tank overflow. – Have the on-site water drain cleaned by a service technician.
 Various	Tap the pictogram and note the error code. Contact an authorised service technician and provide the error code.

By tapping the pictogram, additional information will appear on the display.

See also

- 📖 Washing [▶ 33]
- 📖 Replace the container [▶ 41]
- 📖 Descale [▶ 21]

7.2 Display the error with error code

If a serious error is present, washing is no longer possible and a red bar appears at the top of the display:

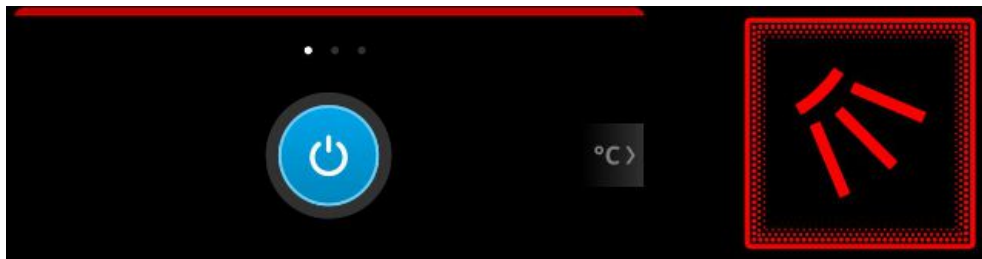
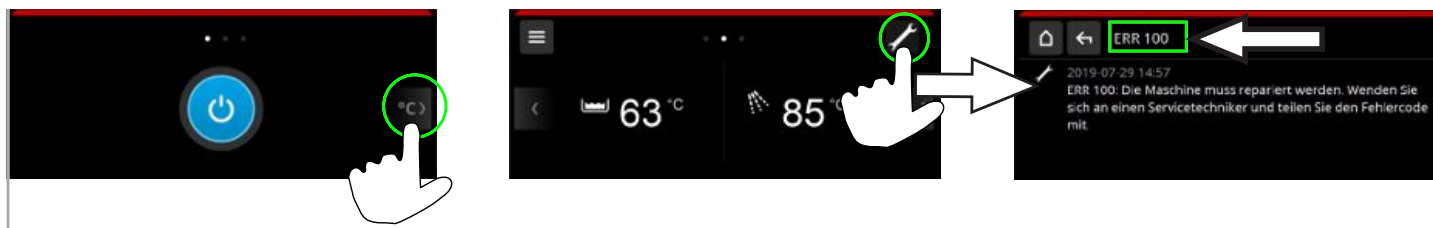
**Accessing the error code**

7.3 Poor wash result

	Possible cause	Remedy
Wash items not clean	No or low detergent dosing	Set the dosing amount as per the manufacturer's specifications (▶ 18). Check the dosing hose (for kinks, breakage, etc.). Vent the dosing device. Replace the container, if empty.
	Wash items incorrectly sorted	Sort wash items correctly (▶ 33).
	Jets of the wash arms blocked	Dismantle wash arms and clean jets (▶ 39).
	Temperatures too low	Check the temperatures (▶ 13).
	Tank water too heavily soiled	Start the tank water exchange programme (▶ 34).
Spots visible on the wash items	If scaling is present: The water is too hard	Check the external water treatment. Connect water treatment. Carry out basic cleaning.
	For starch residues: Temperature of manual pre-cleaning exceeds 40 °C	Lower the temperature of manual pre-cleaning.
The wash items do not dry on their own	No or low rinse aid dosing	Set the dosing amount as per the manufacturer's specifications (▶ 18). Check the dosing hose (for kinks, breakage, etc.). Vent the dosing device. Replace the container, if empty.
	Rinse temperature too low	Contact an authorised service technician.

Note: Water quality affects washing and drying result. We therefore recommend that the warewasher be supplied with softened water from a total hardness of more than 3 dH (0.53 mmol/l).

See also

- 📖 Dosage [▶ 18]
- 📖 Info display [▶ 13]
- 📖 Changing the tank water [▶ 34]
- 📖 Washing [▶ 33]
- 📖 Drainage programme [▶ 39]

8 Cleaning and maintenance

8.1 Cleaning the warewasher during operation



Caution

Risk of chemical burns due to chemicals

After the wash, wash water with chemicals continues to adhere to the filters and wash arms.

➤ Wear protective clothing, protective gloves and protective goggles.

During the work day:

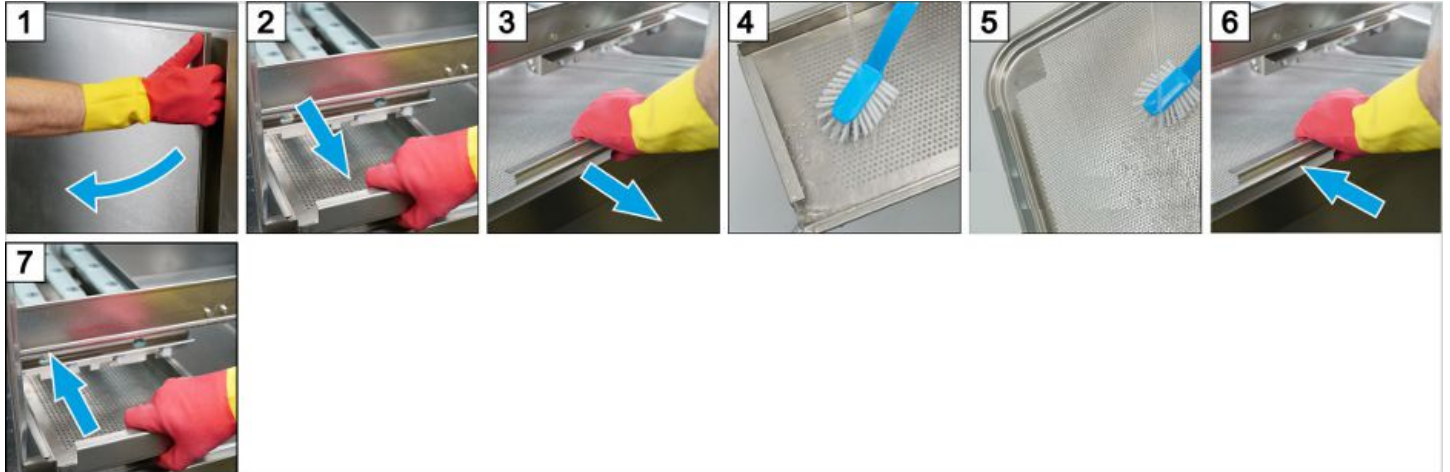

The filter cassette (Figure 2) is available only for warewashers without a pre-wash zone.

Additionally for warewashers with dual rinse

During the work day:



Additionally for warewashers with energy module

Daily before draining the warewasher:

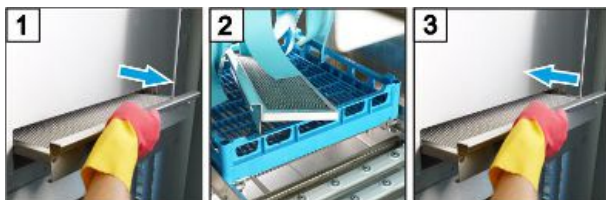

8.2 Drainage programme

The drainage programme is helpful in cleaning the interior of the warewasher at the end of the work day.

- Observe the instructions in the videos on the display. If the videos are ignored, the drainage programme will continue automatically.



Additionally for warewashers with dual rinse

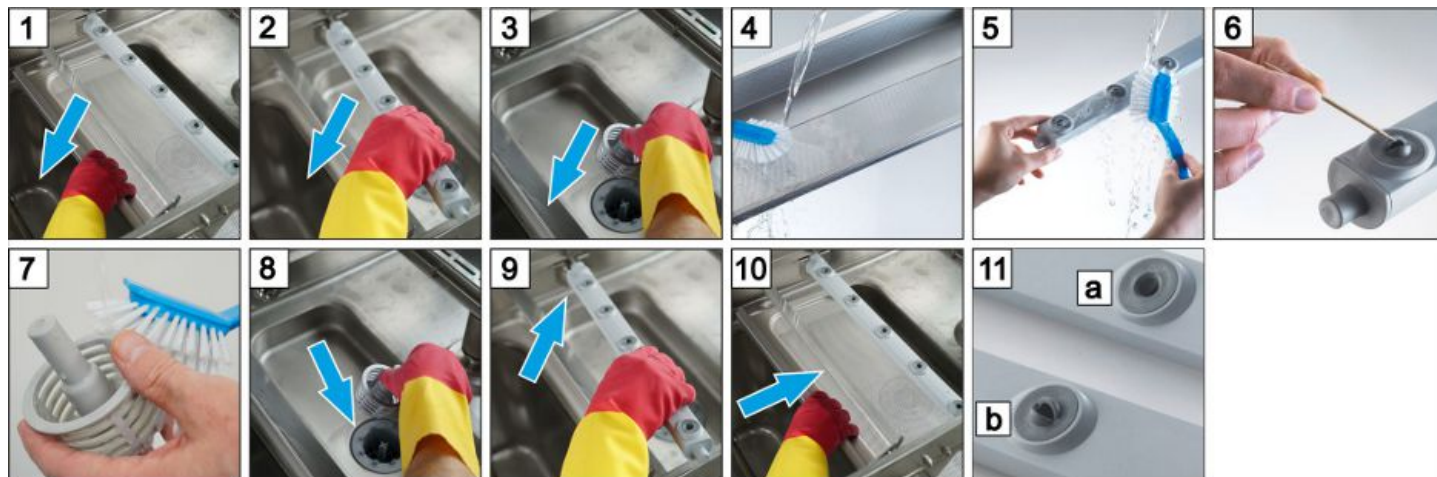

When inserting the wash arms, pay attention to the different jets:

11a: Wash arm in the rinse zone

11b: Wash arm of the pre/main wash zone

Additionally for warewashers with pre-wash zone M



Terminating the drainage programme

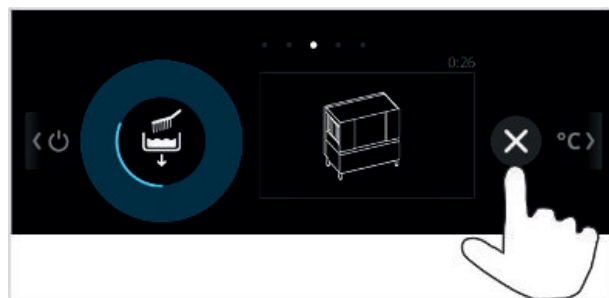

8.3 Fast drainage programme

In the fast drainage programme only the water is pumped out of the warewasher. The warewasher switches off once it is emptied.

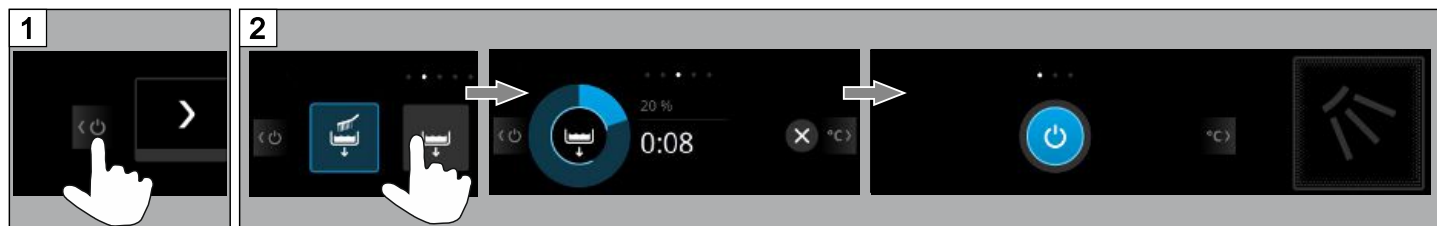

8.4 Replace the container

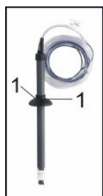

- Wear protective clothing, protective gloves and protective goggles.
- Pull the suction tube carefully out of the empty container.
- Ensure that both vent holes (1) in the caps are open.
- Place suction tube in the new container.
- Slide the cap slowly downwards until the container opening is closed.

The dosing device must be vented if air has entered the dosing hose. This occurs if the container is not replaced in time.

- Access the following menu:

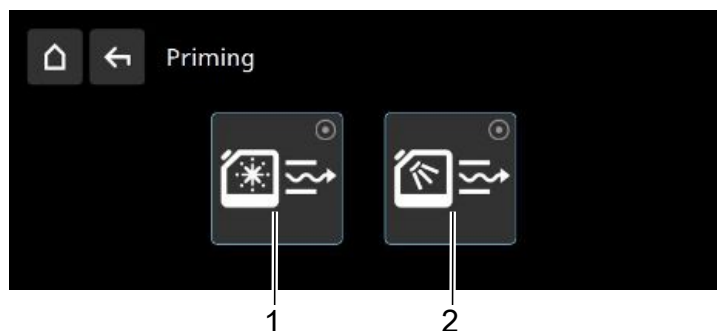

Item	Name
1	Rinse aid dosing device
2	Detergent dosing device

- Press button 1 or 2.
 - ⇒ The dosing device is vented. (120 s)
- Press button 1 or 2 again.

8.5 Change the chemical product

Crystallisation can occur as a result of mixing different chemical products, which can damage the dosing device. Therefore, the dosing device and the dosing hoses must be flushed with water before a new chemical product is used. If this is not done, the Winterhalter Gastronom GmbH warranty and product liability will be void.

- Remove the suction tube from the container and place it in a water-filled container.
- Access the following menu:

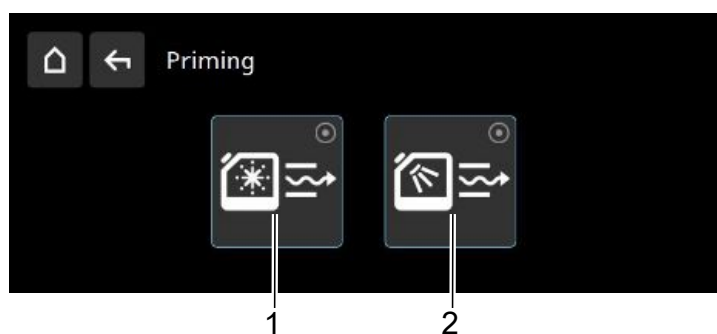

Item	Name
1	Rinse aid dosing device
2	Detergent dosing device

- Press button 1 or 2.
 - ⇒ The button turns white, and the dosing device is activated (120 s).
 - ⇒ The dosing hoses and the dosing device are rinsed out with water.
- As soon as the button goes dark, place the suction tube into the new container.
- Press button 1 or 2 again.
 - ⇒ The button turns white, and the dosing device is activated (120 s).
 - ⇒ The water in the dosing hoses and dosing device is replaced by the new chemical product.

In addition, the dosage must also be reset.

- To attain good wash results, commission an authorised service technician.

8.6 Cleaning the interior

To achieve an optimal wash result and to increase the service life of the warewasher, we recommend cleaning the interior daily.



Note

Risk of rust due to foreign bodies

Damaged wire grate baskets, wash items that are not rust-free, incorrect cleaning utensils and water pipes not protected from rust can cause corroding foreign bodies to enter the interior of the warewasher. These foreign bodies can also cause the material "stainless steel" to corrode.

- Use only undamaged wire grate baskets, suitable wash items and suitable cleaning utensils.

The following materials must **not** be used for cleaning:

- High-pressure cleaner, steam jet
- Detergents containing chlorine or acid
- Cleaning sponges or wire brushes containing metal
- Abrasives or abrasive cleaning agents
- Hose down the interior with a water hose.
- Remove dirt with a brush or a cloth.

8.7 Cleaning the outside of the warewasher

The following materials must **not** be used for cleaning:

- High-pressure cleaner, steam jet
- Detergents containing chlorine or acid
- Cleaning sponges or wire brushes containing metal
- Abrasives or abrasive cleaning agents
- Clean the display with a damp cloth.
- Clean the external surfaces using a stainless steel cleaner and stainless steel polish.

8.8 Descale the warewasher

If the warewasher is operated with hard water and without water treatment, then the boiler, the interior of the machine, all the water lines and components may develop scale. Grease residues and dirt that remain in the machine can contribute towards hygiene risks, while scaling can lead to failure of heating elements. Regular removal of this scaling is therefore necessary / essential.

The descaling programme can be used to descale the interior of the machine (▶ 21).

The water lines and the boiler can be descaled only by an authorised service technician.

See also

- 📖 Descale [▶ 21]

8.9 Maintenance by the customer service department

We recommend that you have an authorised service technician carry out maintenance of the warewasher at least once a year so that vulnerable components subject to ageing and wear can be checked and replaced accordingly. Original spare parts must be used for repairs or to replace consumable parts.

Consumable parts are, e.g.:

- Dosing tubes
- Supply hose
- Curtains

Service interval



The warewasher control unit specifies the number of operating hours or wash cycles at which the pictogram for service is shown.

Note: This function is deactivated ex-factory. On request, the service technician can activate this function.

9 Disassembly and disposal

9.1 Taking the warewasher out of operation for long production stops

If the warewasher is taken out of operation for long periods (company holidays, seasonal operation), carry out the following steps:

- Use the drainage programme to empty the warewasher.
- Clean the warewasher.
- Leave the door open in the detent position.
- Close the on-site water supply.
- Switch off the on-site mains isolation switch.

If the warewasher is in a place that is not frost-free:

- Instruct an authorised service technician to make the warewasher frost-free.

9.2 Disassembly

- Remove any wash items and baskets from the warewasher.
- Empty the warewasher completely.
- Disconnect the warewasher from the on-site electrical connection.
- Disconnect the warewasher from the on-site water supply.
- Disconnect the warewasher from the on-site water disposal.
- Disassemble the table system.
- Disassemble the exhaust air system, if present.

9.3 Disposal

Incorrect or negligent disposal can cause considerable environmental pollution and/or damage.

- For hazardous substances, please observe the disposal regulations listed in the safety data sheets.
- Disposal according to national regulations.

10 Annex

10.1 Declaration of Conformity



Original

EG-Konformitätserklärung

EC declaration of conformity, ES prohlášení o shodě, Δήλωση συμμόρφωσης ΕΚ, Declaración de conformidad CE, Déclaration CE de conformité, Dichiarazione CE di conformità, EU-conformiteitsverklaring, Deklaracja zgodności WE, Declaração CE de conformidade, ES-izjava o skladnosti, EG-försäkrän om överensstämmelse, Декларацията за съответствие на ЕО, EF-overensstemmelseserklæringen, EU vastavusdeklaratsioon, EZ izjava o sukladnosti, EK-megfelelőségi nyilatkozatnak, EB atitikties deklaracija, EK atbilstības deklarācijā, Declarația de conformitate CE, ES vyhlášení o zhode

Wir, We, My, Εμείς η, Nosotros, Nous, Noi, Wij, My, Nós, Podjetje, Vi, Ние, Vi, Ettevõtte, Mi, Mi a, Mes, Mēs, –, My, Biz

Hersteller / Manufacturer:	Winterhalter Gastronom GmbH Winterhalterstraße 2–12 DE-88074 Meckenbeuren
-----------------------------------	--

DE **erklären in alleiniger Verantwortung, dass das Produkt „Gewerbliche elektrische Spülmaschine“**,
EN declare under our sole responsibility that the product "Commercial electric dishwashing machines",
CS prohlášíme na vlastní zodpovědnost, že produkt „profesionální elektrická myčka“,
EL δηλώνουμε αποκλειστικά με δική μας ευθύνη, ότι το προϊόν „Επαγγελματικό ηλεκτρικό πλυντήριο πιάτων“,
ES declaramos bajo nuestra absoluta responsabilidad que el producto „lavavajillas eléctrico industrial“,
FR déclarons sous notre seule responsabilité que le produit « Lave-vaisselle professionnelle électrique »,
IT dichiariamo sotto la nostra piena responsabilità che il prodotto "Sistema di lavaggio elettronico industriale",
NL verklaren als enig verantwoordelijke dat het product „ professionele vaatwasmachine“,
PL oświadczamy na własną odpowiedzialność, że produkt „elektryczna zmywarka przemysłowa“,
PT declaramos sob nossa única responsabilidade, que o produto "Máquina de lavar loiça comercial eléctrica",
SL na lastno odgovornostjo izjavlja, da je izdelek „Profesionalni električni pomivalni stroj“,
SV förklarar som ensam ansvariga, att produkten "Kommersiell elektrisk diskmaskin",
BG декларираме на наша отговорност, че продуктът „Професионална електрическа миална машина“,
DA erklærer under almindeligt ansvar, at produktet »erhvervsmæssig elektrisk orpaskemaskine«,
ET kinnitab oma ainuvastutuse, et tööstuslik elektriline nõudepesumasin,
HR izjavljujemo pod svojom isključivom odgovornošću da proizvod „Profesionalne električne perilice“,
HU felelősségünk teljes tudatában kijelentjük, hogy a termék „Professzionális elektromos mosogatógép“,
LT prisiimdami visą atsakomybę deklaruojame, kad gaminys „Pramoninė elektrinė plovimo mašina“,
LV uzņemties pilnu atbildību, paziņojam, ka izstrādājums «Profesionālā elektriskā trauku mazgājamā mašīna»,
RO Declaram pe propria răspundere că produsul „Mașină de spălat electrică de uz comercial“,
SK vyhlasujeme vo výhradnej zodpovednosti, že výrobok „Profesionálna elektrická umývačka riadu“,
TR oiarak yegane sorumlugumuz dahilinde beyan ederiz ki Sanayi bulasik Makinesi,

Typenbezeichnung / Model: CTR
Warenzeichen / Trademark: Winterhalter

DE **auf das sich diese Erklärung bezieht, mit den folgenden Normen übereinstimmt:**
EN to which this declaration relates is in conformity with the following standards:
CS na kterou se vztahuje toto prohlášení, odpovídá níže uvedeným normám:
EL στο οποίο αναφέρεται αυτή η δήλωση, συμφώνει με τα ακόλουθα πρότυπα:
ES al que se refiere esta declaración, cumple las siguientes normas:
FR auquel se réfère cette déclaration est conforme aux normes:
IT al quale fa riferimento la presente dichiarazione, è conforme alle seguenti norme:
NL waarop deze verklaring betrekking heeft, met de volgende normen in overeenstemming is:
PL do którego odnosi się to oświadczenie, jest zgodny z następującymi normami:
PT ao qual esta declaração diz respeito, está em conformidade com as seguintes normas:
na kateraga se nanaša ta izjava, skladien z naslednjimi standardi:
SV som denna försäkrän gäller, överensstämmer med följande standarder:
BG за който се отнася тази декларация, отговаря на следните стандарти:
DA som denne erklæring beror på, er i overensstemmelse med de følgende standarder:
ET mille kohta see deklaratsioon on välja antud, on vastavuses järgmiste normidega:
HR na koji se odnosi ova izjava, udovoljava sljedećim normama:
HU amihez kapcsolódóan ezen nyilatkozat megfelel a következő szabványoknak:
LT kuriam taikoma ši deklaracija, atitinka toliau išvardytus standartus:
LV uz kuru attiecas šī deklarācija, atbilst šādiem standartiem:
RO la care se referă această declarație, corespunde cu următoarele standarde:
SK na ktorý sa vztahuje toto vyhlášení, vyhovuje nasledujúcim normám:
TR aşadaki standartlara uygundur:

EN 50416:05 + A1:15	EN 61000-3-11:00	EN 300 328 V.2.2.2
EN 55014-1:17	EN 61000-3-12:11	EN 301 489-1 V2.1.1
EN 55014-2:15	EN 62233:08/AC:08	EN 301 489-17 V3.1.1
EN 60335-1:12 + A11:14/AC:14 + A13:17		

DE gemäß den Bestimmungen folgender Richtlinien:	IT ai sensi alle disposizioni previste dalle seguenti direttive:
EN following the provisions of Directives:	NL volgens de bepalingen van de volgende richtlijnen:
CS na základě ustanovení následujících směrnic:	PL zgodnie z postanowieniami następujących dyrektyw:
EL σύμφωνα με τους κανονισμούς των ακόλουθων Οδηγιών:	PT de acordo com as disposições das seguintes directivas:
ES conforme a las disposiciones de las siguientes directivas:	SL in je skladien z določili naslednjih direktiv:
FR selon les conditions des directives suivantes:	SV enligt bestämmelserna i följande direktiv:
BG съгласно разпоредбите на следните директиви:	LT pagamintas vadovaujantis toliau išvardytų direktyvų nuostatomis:
DA iht. bestemmelserne fra følgende direktiver:	LV atbilstoši šādu direktīvu noteikumiem:
ET kooskõlas järgmiste direktiivide sätetega:	RO conform dispozițiilor următoarelor directive:
HR u skladu s odredbama sljedećih direktiva:	SK v súlade s ustanoveniami nasledujúcich smerníc:
HU a következő Irányelvek rendelkezéseinek:	TR aşadaki Direktif hükümlerine uygundur:

2006/42/EC (Machinery Directive) 2014/30/EU (Electromagnetic Compatibility Directive) 2014/53/EU (Radio Equipment Directive) 2011/65/EU (Directive on the restriction of the use of certain hazardous substances in electrical and electronic equipment)

DE **Name und Anschrift der Person, die bevollmächtigt ist, die technischen Unterlagen zusammenzustellen:**
 EN Name and address of the person authorised to compile the technical file:
 CS Jméno a podpis osoby, která je pověřena sestavením technické dokumentace:
 EL Όνομα και διεύθυνση του ατόμου, το οποίο είναι εξουσιοδοτημένο να συντάσσει τεχνικούς φακέλους:
 ES Nombre y dirección de la persona facultada para elaborar el expediente técnico:
 FR Nom et adresse de la personne autorisée à constituer le dossier technique :
 IT Nome e indirizzo della persona responsabile della compilazione della documentazione tecnica:
 NL Naam en adres van de persoon die gemachtigd is om de technische documenten samen te stellen:
 PL Nazwisko i adres osoby odpowiedzialnej za przygotowanie dokumentacji technicznej:
 PT Nome e endereço da pessoa responsável pela compilação da documentação técnica:
 SL Naziv in naslov osebe, ki je pooblaščen za pripravo tehnične dokumentacije:
 SV Namn på och adress till den person som är behörig att ställa samman den tekniska dokumentationen:
 BG Име и адрес на лицето, упълномощено да състави техническата документация:
 DA Navn og adresse på personen, som er bemyndiget til at sammensætte de tekniske dokumenter:
 ET Tehnilise dokumentatsiooni koostamiseks volitatud isiku nimi ja aadress:
 HR Ime i adresa osobe koja je ovlaštena za izradu tehničke dokumentacije:
 HU A műszaki dokumentáció összeállítására felhatalmazott személy neve és címe:
 LT Asmens, įgalioto parengti techninę dokumentaciją, vardas ir pavardė:
 LV Personas, kura ir pilnvarota sastādīt tehnisko dokumentāciju, vārds un adrese:
 RO Numele și adresa persoanei împuternicite să întocmească documentația tehnică:
 SK Meno a adresa osoby oprávnenej na zostavenie technickej dokumentácie:
 TR Teknik dokümanları derlemekle yetkili kişinin adı ve adresi:

Bernhard Graeff
Winterhalter Gastronom GmbH
Winterhalterstraße 2–12
DE-88074 Meckenbeuren

Anbringung der CE Kennzeichnung /
CE Marking date: 2019

Meckenbeuren, 19.12.2019

 Bernhard Graeff
 Group Management Committee
 Vice President Engineering

 Marco Bertiller
 Director Winterhalter Product & Technology GmbH

Winterhalter Gastronom GmbH
Gewerbliche Spülsysteme

Winterhalterstr. 2-12
88074 Meckenbeuren
Deutschland

Telefon: +49 (0) 7542 4 02-0

www.winterhalter.de
info@winterhalter.de

Winterhalter Gastronom GmbH
Commercial Dishwashing Systems

Winterhalterstr. 2-12
88074 Meckenbeuren
Germany

Telephone: +49 (0) 7542 4 02-0

www.winterhalter.com
info@winterhalter.com