

INDUSTRY
KITCHENS

www.industrykitchens.com.au 1800 611 058



The Volano B2 Vintage-Style Flywheel Slicer is craftsman-built to the highest standard using high quality modern materials and fitted with safety features.



Model
Volano BKL-B2
Flywheel Slicer



Hand Powered

Model BKL-B2 Flywheel Slicer

CE Approved

The Volano B2 Flywheel Slicer is an unpowered hand operated precision slicer.

- Quality unpowered flywheel slicer with 265mm blade
- Stunning Vintage flower design flywheel
- Constructed from aluminium and stainless steel with a high gloss red or black finish
- Fully incorporated sharpening device
- Slice thickness: 0-1.35mm
- Blade ring guard
- Optional extra: High gloss enamel vintage style stand.

B2

Dimensions

W x D x H (mm):	530 x 675 x 603
Pedestal Stand (mm):	580 x 780
Slice Thickness (mm):	0 - 1.35
Blade (mm):	265
Product Cutting Capacity:	
Rectangle (mm):	190 x 165
Round (mm):	160
Slicer Weight (kg):	33
Stand Weight (kg):	45

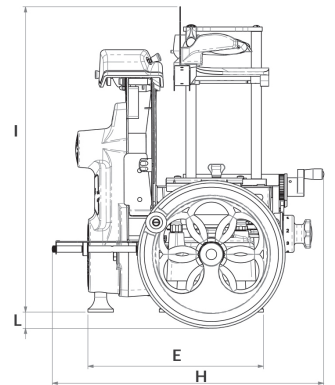
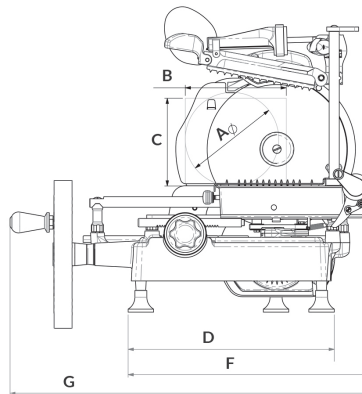

Brice Australia Pty. Ltd. ABN 71 413 589 669
100% Australian owned and operated
Copyright ©2023 Brice Australia Pty. Ltd.

BRICE HEAD OFFICE:
11 Holloway Drive, Bayswater,
Victoria 3153 Australia

Ph: 1300 664 880
www.briceaust.com.au
email: info@briceaust.com.au

