

The Lamderby310 and the Lamderby410 pack and seal food products in pouches.



Models
LAMDERBY310/410



Semi-Automatic; Manual Operation; CE Approved

Vacuum Packers

Model LAMDERBY310/410 Vacuum Packers

These vacuum packing machines pack and seal food products in pouches. The body and chamber are constructed of stainless steel and has a clear heavy duty sealing lid.

- Sealing bar is removeable for cleaning;
- Variable vacuum setting;
- Digital display for time and sealing times;
- CE Approved.

SPECIFICATIONS

	Derby310	Derby410
Sealing Bar	310mm	410mm
Pump Supplied	8mc/h	20mc/h
Overall Dimensions (mm)		
Width	395	510
Depth	465	570
Height	450	525
Chamber Dimensions (mm)		
Width	320	435
Depth	350	455
Height	115+60	115+60
Power	0.6HP, 450w	1HP, 750w
Net weight (kg)	47	80

Lamderby310

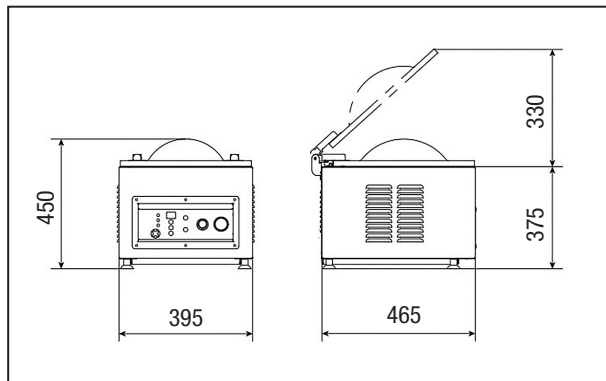

Lamderby410

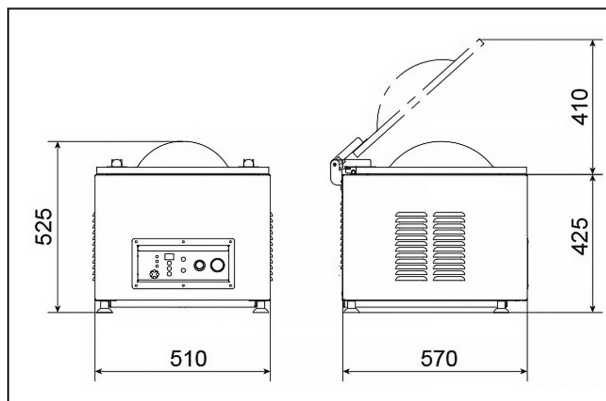

OPTIONAL SEALING BARS CONFIGURATIONS FOR LAMDERBY 410

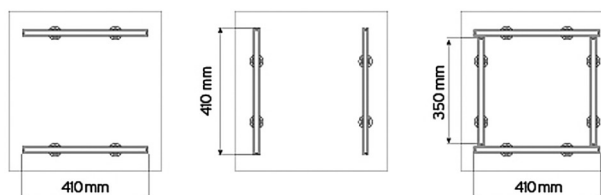

Brice Australia Pty. Ltd. ABN 71 413 589 669
100% Australian owned and operated
Copyright ©2023 Brice Australia Pty. Ltd.

BRICE HEAD OFFICE:
11 Holloway Drive, Bayswater,
Victoria 3153 Australia

Ph: 1300 664 880
www.briceaust.com.au
email: info@briceaust.com.au

